

Lacor

Brand of the Stars · Since 1949



2025

Catalogue



Historia . History

1949-2025

1949



1949

En 1949, Marcos Larrañaga Chinchurreta fundó la empresa "Manufacturas Metálicas Marcos Larrañaga" en un pequeño local del centro de Bergara.

In 1949, Marcos Larrañaga Chinchurreta founded the company Manufacturas Metálicas Marcos Larrañaga in small premises in the centre of Bergara.

1950

Comenzamos a fabricar en aluminio los artículos para uso doméstico y material de ortodoncia para empresas de la comarca del Alto Deba en Gipuzkoa.

We started manufacturing aluminium household items and orthodontic materials for companies in the Alto Deba region in Gipuzkoa.

1950



1960

Trasladamos y ampliamos las instalaciones para poder fabricar menaje de aluminio para el sector de la hostelería y, posteriormente, comenzamos a fabricar las primeras piezas de acero inoxidable para el hogar. Asimismo, decidimos crear la marca comercializadora "Lacor" en honor al matrimonio que formaban el fundador Marcos Larrañaga y su mujer Casimira Cortabarría.

We moved and expanded our facilities in order to manufacture aluminium kitchenware for the hotel and catering industry and then started to manufacture the first stainless steel household articles. We also decided to create the brand name "Lacor" in honour of the married couple formed by the founder, Marcos Larrañaga, and his wife, Casimira Cortabarría.

1970

Mejoramos las piezas de acero inoxidable incluyendo el fondo difusor, además de ampliar la gama para el sector profesional. Comenzamos a exportar nuestros productos a los países contiguos Francia y Portugal.

We improved the stainless steel items by including a heat-diffusing bottom, as well as extending the professional kitchenware range. We started exporting our products to the neighbouring countries of France and Portugal.

1960



1970



1980



1980

Nos convertimos en el primer fabricante nacional de menaje en grandes dimensiones de acero inoxidable con fondo difusor y de una sola pieza. Así, tuvimos que volver a trasladar y ampliar las instalaciones actuales de Bergara, además de automatizar la producción. Seguimos trabajando para ampliar el catálogo profesional y conseguimos expandir las ventas a los 5 continentes.

We became the first national manufacturer of large single piece stainless steel kitchenware featuring a heat-diffusing bottom, so we had to relocate and expand the current facilities in Bergara, as well as automate production. We continuously strived to expand our professional portfolio and managed to increase sales to 5 continents.

2000

Creamos la empresa "Logística del Menaje" en Alegría-Dulantzi (10.000 m2) con su posterior ampliación hasta los 30.000 m2 para almacenar y gestionar los centenares de pedidos diarios de nuestros clientes. Igualmente, invertimos en las automatizaciones y robotizaciones en la producción para optimizar los recursos y mejorar el acabado de las piezas.

We created the company Logística del Menaje in Alegría-Dulantzi (10,000m2), followed by a subsequent extension to 30,000 m2 to store and manage the hundreds of daily orders from our customers. We also invested in production automation and robotisation to optimise resources and improve finishing of parts

2000



2025...

2025...

Nos consolidamos como marca líder de menaje profesional para hostelería y restauración.

Nuestros productos se caracterizan por el diseño, la calidad y la durabilidad, atributos que día a día conquistan a grandes chefs de todo el mundo.

Tratamos de contribuir a una sociedad saludable y sostenible. Promovemos el aprendizaje y el desarrollo de hábitos de vida saludables incorporando al catálogo materiales seguros y libre de tóxicos.

We have now consolidated our position as a leading brand in professional kitchenware for the hotel and catering industry.

Our products are well-known for their design, quality and durability, features that convince top chefs from all over the world on a daily basis.

We do our best to contribute to a healthy, sustainable society and promote learning and the development of a healthy lifestyle by including safe, toxic-free materials in our catalogue.

Sostenibilidad

Sustainability



Nuestra responsabilidad va más allá de ofrecer menaje de alta calidad: buscamos cuidar de las personas y del planeta. Por eso, nuestros productos están fabricados con materiales libres de tóxicos, siendo seguros para tu salud y para el medio ambiente.

A su vez, hemos dado un paso firme en la reducción del plástico en nuestros embalajes, contribuyendo a minimizar los residuos y a proteger nuestro entorno.

Además, apostamos por la eficiencia energética con nuestra propia instalación de placas solares, que nos permite avanzar hacia la autosuficiencia energética y reducir nuestra huella de carbono.

Cada acción cuenta y cada producto que creamos refleja nuestro compromiso: un menaje de calidad, responsable y pensado para un mundo más sostenible.

Our responsibility goes beyond offering high quality kitchenware: we seek to take care of people and the planet. That's why our products are made from toxic-free materials, making them safe for your health and for the environment.

At the same time, we have taken a firm step towards reducing the use of plastic in our packaging, helping to minimise waste and protect our environment.

We are also committed to energy efficiency with our own solar panel installation, which allows us to move towards energy self-sufficiency and reduce our carbon footprint.

Every action counts and every product we create reflects our commitment: quality, responsible kitchenware designed for a more sustainable world.



Nuestros valores

Nos valeurs · Our values

Liderazgo
Leadership
Leadership

Somos una marca referencia dentro del sector de la hostelería y menaje doméstico. Tras años de esfuerzo nos hemos ganado una posición de liderazgo y nos hemos convertido en un referente en el sector.

Nous sommes une marque de référence dans le secteur de l'hôtellerie et des ustensiles de cuisine. Après des années d'efforts, nous avons acquis une position de leadership et sommes devenus une référence dans le secteur.

We're a leading brand in the hospitality and home kitchenware industries. After years of effort we've earned a leadership position and we're at the forefront of the sector.

Ambición
Ambition
Ambition

Estamos presentes en 90 países a lo largo de los 5 continentes. A través del esfuerzo de nuestros distribuidores, hemos conseguido llegar a las cocinas profesionales y hogares de todo el mundo.

Nous sommes présents dans 90 pays situés sur 5 continents. Grâce à l'effort de nos distributeurs, nous sommes parvenus à rentrer dans les cuisines professionnelles et les foyers du monde entier.

We're present in 90 countries on 5 continents. Through the effort of our distributors we've been able to reach homes and professional kitchens around the world.

Compromiso
Engagement
Commitment

Integramos la cultura de la calidad tanto en los procesos de fabricación y productos como en la relación con nuestros clientes y colaboradores.

Nous intégrons la culture de la qualité aussi bien dans les processus de fabrication et les produits que dans la relation avec nos clients et nos collaborateurs.

We have assimilated the culture of quality in both our manufacturing processes and products and our relationships with clients and collaborators.

Organización
Organisation
Organization

Pertenece a una tierra de profundas raíces gastronómicas donde nuestros artesanos comenzaron a fabricar las primeras cacerolas hace 75 años. Hoy en día mantenemos el mismo espíritu y pasión por nuestra propia historia.

Nous sommes issus d'une région possédant de profondes racines gastronomiques où nos artisans ont commencé à fabriquer les premières casseroles il y a 75 ans. Aujourd'hui, nous avons gardé le même état d'esprit et la même passion pour notre propre histoire.

We belong to a land with deep gastronomical roots where our artisans began to make the first casseroles 75 years ago. Today, we still have the same spirit and passion for our history.

Responsabilidad
Responsabilité
Responsibility

Contamos con un equipo cualificado de personas con un alto grado de responsabilidad hacia el servicio. Gracias a la dedicación diaria, hemos conseguido establecer relaciones duraderas y de confianza con nuestros clientes.

Nous bénéficions d'une équipe de personnes qualifiées avec un haut niveau de responsabilité vis-à-vis du service. Grâce à leur dévouement quotidien, nous avons pu établir des relations durables et de confiance avec nos clients.

We have a qualified team of people with a high degree of responsibility towards service. Thanks to our day in day out dedication, we've been able to build long lasting and trusting relationships with our clients.



Conócenos

Connais-nous · Know us

Fábrica

Usine · Factory

· Fábrica ubicada en Bergara (España)

· Usine située en Bergara (Espagne)

· Factory located in Bergara (Spain)



Almacén

Entrepôt · Warehouse

· Almacén de 30.000 m2 · Capacidad: 42.000 pallets

· Entrepôt de 30.000 m2 · Capacité: 42.000 pallets

· Warehouse 30.000 m2 · Capacity: 42.000 pallets



Distribuidores

Distributeurs · Distributors

· Más de 3200 distribuidores · Presentes en 90 países

· Plus de 3200 distributeurs · Présent dans 90 pays

· More than 3200 distributors · Present in 90 countries



Worldwide

Europe

Andorra · Austria · Belgium · Bulgaria · Czech Republic · Croatia · Cyprus · Denmark · Finland · France · Germany · Greece · Holland · Hungary · Iceland · Ireland · Italy · Latvia · Lithuania · Luxembourg · Macedonia · Montenegro · Poland · Portugal · Romania · Russia · Serbia · Slovenia · Spain · Sweden · Switzerland · Turkey · UK+ N. Ireland · Ukraine

America

Argentina · Bolivia · Brazil · Canada · Chile · Colombia · Costa Rica · Cuba · Dominican Rep. · French Guayana · Guadalupe · Guatemala · Honduras · Jamaica · Martinique · Mexico · Paraguay · Peru · United States · Uruguay

Asia

Azerbaijan · Cambodia · China · Hong Kong · India · Indonesia · Iran · Iraq · Israel · Japan · Jordan · Kazakhstan · Kuwait · Lebanon · Macau · Malaysia · Philippines · Qatar · Russia · Saudi Arabia · Singapore · South Korea · Sri Lanka · Taiwan · Thailand · UAE · Vietnam

Africa

Algeria · Burkina Faso · Cape Verde · Egypt · Ethiopia · Ivory Coast · Kenya · Libya · Mauricio · Morocco · Reunion Island · Senegal · Seychelles · South Africa · Tunisia

Oceania

Australia · New Zeland



Leyenda Materiales

















Légende · Legend Matériaux · Materials

| | | |
|----------|---|--------------------------------------|
| A | Acacia Bois d'acacia Acacia wood | Acacia Wood |
| | Acero cromado Acier chromé Chrome steel | Acero Cromado Chrome sell |
| | Acrílico Acrylique Acrylic | ASA Acrylic |
| | Acrilonitrilo butadieno estireno (termoplástico) Acrylonitrile Butadiène Styrene (Thermoplastique) Acrylonitrile Butadiene Styrene (Thermoplastic) | ABS Plastic |
| | Aluminio Aluminium Aluminium | AL Aluminium |
| B | Bambú Bois de bambou Bamboo wood | Bambú Bamboo |
| C | Caucho termoplástico Caoutchouc thermoplastique Thermoplastic rubber | TPR Plastic |
| | Cerámico Céramique Ceramic | CE Ceramic |
| | Cristal Verre Glass | Cristal Glass |
| E | Elastómero termoplástico Élastomère thermoplastique Thermoplastic elastomer | TPE Plastic |
| F | Fibra de vidrio Fibre de verre Fiberglass | Fibra de vidrio Fiberglass |
| | Forjado Forgée Wrought | FO Forjado Wrought |
| | Fundido Fondu Cast | FU Fundido Cast |
| H | Haya Bois de hêtre Beech wood | Haya Beech Wood |
| | Hierro Fer Iron | FE Iron |
| | Hierro colado Fonte Cast iron | Hierro colado Cast iron |
| I | Inoxidable Acier inoxydable Stainless steel | Inox |
| | Inoxidable 18/10 Acier inoxydable 18/10 Stainless steel 18/10 | Inox 18/10 |

| | | |
|----------|--|-------------------------------------|
| M | Madera de caucho Bois de caoutchouc Rubber wood | Madera Caucho Rubber wood |
| | Material embutido Matériel d'incrustation Inlaying material | Embutición Deep Drawn |
| | Melamina (trímero) Mélamine (trimère) Melamine (trimer) | MF Melamine |
| N | Nylon Nylon Nylon | PA Nylon |
| P | Pizarra natural 100% 100% ardoise naturelle 100% natural Slate | Pizarra Slate |
| | Plástico estireno acrilonitrilo Plastique acrylonitrile styrène Acrylonitrile styrene plastic | SAN Plastic |
| | Plástico polimetilmetacrilato Plastique polyméthacrylate de méthyle Polymethyl methacrylate plastic | PMMA Plastic |
| | Policarbonato Polycarbonate Polycarbonate | PC Polycarbon |
| | Poliestireno (polímero termoplástico) Polystyrène (polymère thermoplastique) Polystyrene (thermoplastic polymer) | PS Plastic |
| | Poliétileno (polímero) Polyéthylène (polymère) Polyethylene (polymer) | PE Polyethylene |
| | Poliétileno de alta densidad (polímero) Polyéthylène haute densité (polymère) High-density polyethylene (polymer) | HPPE Polyethylene |
| | Poliétileno de baja densidad (polímero) Polyéthylène basse densité (polymère) Low density polyethylene (polymer) | PELD Polyethylene |
| | Poliétileno de baja densidad (polímero) Polyéthylène basse densité (polymère) Low density polyethylene (polymer) | LDPE Polyethylene |
| | Polipropileno (polímero) Polypropylène (polymère) Polypropylene (polymer) | PP Polypropilene |
| S | Silicona Silicone Silicone | Si Silicone |
| Z | ZAMAK ZAMAK ZAMAK | Zinc Alloy |
| | Zirconia Zircone Zirconia | CZ Zirconia |

Leyenda Características

Légende · Legend Caractéristiques · Characteristics

| | | |
|----------|--|---|
| A | Anodizado Anodisé Anodized |  |
| | Antiadherente libre de PFOA Antiadhésif sans PFOA PFOA free non-stick |  |
| | Antiadherente Antiadhésif Non-stick |  |
| | Apto para el lavavajillas Lave-vaisselle Dishwasher safe |  |
| | Apto para llama Convient pour la flamme Suitable for flame |  |
| | Apto para el congelador Va au congélateur Freezer safe |  |
| | Apto para el horno Va au four Oven safe |  |
| | Apto para el microondas Va au micro-ondes Microwave safe |  |
| | Artículo apilable Article empilable Stackable item |  |
| C | Certificado de Conformidad Europea Certificat de conformité européen European Certificate of Conformity |  |
| | Certificado en gestión forestal y cadena de custodia Certifié en gestion forestière et chaîne de contrôle Certified in forest management and chain of custody |  |
| | Certificado ISO 14001. Sist. de gestión ambiental Certificat ISO 14001. Syst. gestion environnementale ISO 14001 certificate. Syst. environmental management |  |
| | Cocina eléctrica Cuisinier électrique Electric cook |  |
| | Cocina de gas Cuisinière à gaz Gas cook |  |
| | Cocina de inducción Cuisinier à induction Induction cook |  |
| | Cocina vitrocerámica Cuisinier vitrocéramique Vitroc ceramic cook |  |
| | Cocina saludable Cuisine saine Healthy cooking |  |

| | | |
|----------|--|---|
| D | Directiva 2011/65/UE de Restricción de ciertas Sust. Peligrosas Directive 2011/65 / UE sur les restrictions de certaines substances dangereuses Directive 2011/65 / EU on Rest. of Certain Hazardous substances |  |
| | Dureza del artículo Dureté de l'article Item Hardness | 87 HRc |
| E | Etiqueta ecológica para productos textiles Label écologique pour les produits textiles Eco label for textile products |  |
| F | Fondo sandwich Fond de sandwich Sandwich background |  |
| L | Lavar con un trapo húmedo Laver avec un chiffon humide Wash with a damp cloth |  |
| | Libre de BPA Sans BPA BPA free |  |
| M | Material blando y flexible Matériau souple et flexible Soft and flexible material |  |
| | Material ecológico Matériel écologique Ecological material |  |
| | Motor de corriente alterna Moteur à courant alternatif Alternating current motor |  |
| | Motor de corriente continua Moteur à courant continu Continuous current motor |  |
| N | Nivel de protección al polvo y agua Niveau de protection contre la poussière et l'eau Dust and water protection level | IP20 |
| | Nivel de temperatura máxima Niveau de température maximum Maximum temperature level | 200°C max |
| | Nº de capas del antiadherente Nombre de couches antiadhésives No. of non-stick layers | 3 Capas/Layer |
| | Nº de hojas que tiene el portamenu Nombre de feuilles dans le support de menu Number of sheets in the menu holder | 6/4/4 |
| | Normas creadas por Comités Técnicos de Normalización de la Asociación Española Normes créées par les comités de normalisation technique de l'Association espagnole Standards created by the Technical Standardization Committees of the Spanish Association |  |
| P | Peso que puede aguantar el artículo Poids que l'article peut contenir Weight the item can hold | 120 Kg |
| | Prohibido transportar en avión Interdit de transporter en avion Forbidden to transport by plane |  |

 **Todo aquel icono de la lista de la leyenda que contenga un aspa en rojo significa que no es apto.**
Toute icône de la liste contenant une croix rouge signifiera qu'elle ne lui convient pas.
Jedes Symbol in der Legendenliste, das ein rotes Kreuz enthält, bedeutet, dass es nicht dafür geeignet ist.
Any icon in the legend list that contains a red cross will mean that it is not suitable for it.
Qualquer ícone na lista de legendas que contenha uma cruz em vermelho, significa que não é adequado.

Novedades

Nouvelles · Novelties



Batería Gastro
Battery
« 29 »



Set 3 cazos Combi
Set 3 saucepans + handle
« 35 »



Cuscusera
Couscous maker
« 55 »



Bandeja con rejilla Essential
Tray with rack
« 113 »



Tapete microperforado White
Micro-perforated mat
« 117/350 »



Guante de cocina Vichy y Black
Kitchen glove
« 118 »



Colección Aqua Garinox
Aqua Garinox Collection
« 131 »



Espátula acodada
Angled spatula
« 135 »



Set de 3 utensilios
Set of 3 utensils
« 135 »



Wok Foodie
Wok
« 39/103 »



Crepera Foodie
Crepiere
« 39/103 »



Batería Caliza
Battery
« 52 »



Cacillo Select
Ladle
« 135 »



Escurridor Inox
Straine
« 148 »



Escurridor plegable
Folding strainer
« 148 »



Bandeja oval MAGMA
Oval tray
« 67/251 »



Sartén Garinox
Frying-pan
« 82 »



Crepera Ferrum
Crepiere
« 89 »



Embudo Dosificador
Embudo Dosificador
« 150 »



Prensa ajos Dual
Garlic press
« 156 »



Prensador carne Magma
Meat press
« 159 »



Sartén Kale
Frying-pan
« 90 »



Sartenes Cuisine
Frying pans
« 104 »



Llauna de arroz
Rice launa
« 113 »



Colección Smart
Smart Collection
« 162 »



Organizadores Organizer
Organisers Organizer
« 163 »



Recipiente rectangular Ecolnox/Etern
Rectangular container
« 179/180 »



Recipiente TwoGo
Container ·
« 181 »



Báscula plataforma
Platform scale
« 182 »



Báscula digital ultraprecisión Doble
High precision dual platform digital scales ·
« 184 »



Báscula con bol Just
Scales with bowl ·
« 184 »



Báscula de baño Silver
Bathroom scales
« 187 »



Rallador Cónico
Conical grater
« 201 »



Melamina
Melamine
« 241/242 »



Wood Collection
Colección Madera
« 244 »



Mini cocotte Serve
Mini cocotte
« 246 »



Set 3 ramequines
Set of 3 ramekins
« 253 »



Bandeja Share
Tray
« 253 »



Bandeja Olive
Tray
« 253 »



Mandolina vertical Plus
Vertical mandoline
« 202 »



Mandolina bidireccional Fast
Dual slice mandoline
« 203 »



Colección Select
Select Collection
« 208 »



Encendedores de gas
Gas lighter
« 262 »



Molinillo Black
Grinder
« 266 »



Cascanueces Wood
Nut Cracker
« 272 »



Set de cuchillos Monoblock
Micro serrated knife set
« 216 »



Bloque magnético Magnet
Magnetic block Magnet
« 219 »



Afilador de precisión 6 en 1
Precision sharpener
« 220 »



Mantel individual Oval
Oval individual placemat
« 275 »



Vaso termo Ocean
Thermo tumbler
« 282 »



Cafetera automática Sabore
Automatic coffee machine
« 286/528 »



Afilador de cuchillos Drei
Knife sharpener
« 221/559 »



Tabla de corte para pan GN 1/1
Bread cutting board GN 1/1
« 222 »



Organizador Compact
Compact Organiser
« 226 »



Cafetera Francesa Inox
French coffee maker inox
« 289 »



Lecheras White
Milk jug · Leitera barista
« 292 »



Soporte de copas Due
Cups stand
« 304 »



Vaso Julep Mug
Tumbler

<< 306 >>



Cortapastas extensible rizado
Dough divider expandable

<< 331 >>



Sopletes de gas/Cartucho de gas
Gas torch /Gas cartridge

<< 334/335 >>



Batidora Provite
Mixer

<< 477 >>



Deshidratador de alimentos Dry
Food dehydrator

<< 487 >>



Freidora eléctrica Intact/Vue
Electric fryer

<< 491 >>



Porta menú Saura
Menu cover

<< 370 >>



Porta menú Simone
Menu cover

<< 371 >>



Porta menú Bosco
Menu cover

<< 371 >>



Horno pizza Lecco
Pizza oven

<< 498 >>



Plancha grill Due
Grill plate

<< 504 >>



Cafetera de goteo Drop
Filter coffee machine

<< 526 >>



Chafing Dish Noir
Chafing Dish Noir

<< 390 >>



Cubetas Inducción
Induction Cookware

<< 395 >>



Degustare Transparent
Bolform Blume

<< 397 >>



Máquina de vacío Ingenious
Vacuum machine Ingenious

<< 543 >>



Sous Vide Master
Sous Vide

<< 546 >>



Mini bar Vista
Mini-bar refrigerator

<< 553 >>



Bandeja
Tray

<< 399 >>



Buffet Nord
Buffet

<< 400 >>



Carro portaplatos
Plate trolley

<< 429 >>



Matamosquitos Limpo
Electric mosquito killer

<< 562 >>



Bandeja Servicio Red
Service Tray Network

<< 431 >>



Máquina de helados Artic
Ice cream machine

<< 462 >>



Batidoras Rapid
Blenders

<< 473 >>

Descubre más...
En savoir plus · Find out more

Índice • Index



01

Menaje Cookware

20
Baterías profesionales
Professional cookware

33
Baterías domésticas
Household cookware

70
Ollas a presión
Pressure cooker

79
Sartenes
Frypans

16

02

Utensilios Utensils

126
Juegos de cocina
Kitchen tools

137
Preparación
Food processing

174
Medir y pesar
Measuring and weighing

190
Corte
Cutting

03

Mesa Table Top

230
Bandejas y fuentes
Trays and platters

233
Melamina
Melamine

245
Servicio mesa
Table service

274
Manteles y salvamanteles
Tablecloths and placemats

278
Termos y botellas
Thermos · bottles

283
Cafetería
Coffee

294
Bar bodega
Wine cellar

04

Repostería Pastry-making

318
Utensilios y preparación
Pastry processing

344
Moldes y aros
Moulds and rings

05

Restauración Restoration

362
Porta menú y pizarras
Portamenu y blackboards

383
Buffet
Buffet

417
Cubetas
Container

420
Transporte y almacenamiento
Transport and Shelves

06

Eléctrico Electric

454
Eléctrico
Electric



17

01

Menaje
Cookware





Chef Luxe



- **Toda la pieza (cuerpo, asas y mangos) fabricada en acero inoxidable 18/10.**
- **Fondo termodifusor (inox 18/10 - aluminio - inox).**
- **Espesor 1,5 - 2 mm.**
- **Tapas diseñadas para el ahorro energético.**
- **Máxima garantía en cuanto a resistencia, durabilidad e higiene.**
- **Apta para todos los tipos de cocina (incluida inducción y horno).**

- **Toute la pièce (corps, poignées et manches) est fabriquée en acier inoxydable 18/10.**
- **Fond thermo-diffuseur (Inox 18/10 - Aluminium - Inox).**
- **Épaisseur 1,5 - 2 mm.**
- **Couvercles conçus pour une économie d'énergie.**
- **Garantie maximale en termes de résistance, de durabilité et d'hygiène.**
- **Compatible avec tous les types de cuisinières (et compris induction et four).**

- **The whole product (body, handles and grips) is made in 18/10 stainless steel.**
- **Heat diffuser bottom (18/10 stainless steel - Aluminium - Stainless).**
- **Thickness 1.5 - 2 mm.**
- **Covers designed for saving energy.**
- **Maximum guarantee in terms of resistance, durability and hygiene.**
- **Suitable for all types of cooking surfaces (including induction and the oven).**



Cacerola con tapa

Faitout avec couvercle · Bratentopf mit Deckel
Casserole with lid · Caçarola com tampa

| Ref | € | Ø (cm) | h(cm) | e (mm) | L | U.Venta |
|---------|--------|--------|-------|--------|-------|---------|
| 54020 | 85,60 | 20 | 10,0 | 1,5 | 2,90 | 1 |
| 54024 | 102,50 | 24 | 11,0 | 1,5 | 4,25 | 1 |
| 54028 | 118,80 | 28 | 11,0 | 1,5 | 6,70 | 1 |
| 54032 | 148,10 | 32 | 12,5 | 1,5 | 10,00 | 1 |
| 54036 | 179,50 | 36 | 14,0 | 1,5 | 14,20 | 1 |
| 54040 | 232,80 | 40 | 15,5 | 2,0 | 19,40 | 1 |
| 54045 | 276,80 | 45 | 17,0 | 2,0 | 27,00 | 1 |
| * 54050 | 347,10 | 50 | 20,0 | 2,0 | 38,20 | 1 |

* **NO inducción** · NON induction · NOT Induction

Cacerola sin tapa

Faitout sans couvercle · Bratentopf ohne Deckel
Casserole without lid · Caçarola sem tampa

| Ref | € | Ø (cm) | U.Venta |
|----------|--------|--------|---------|
| 54020S | 67,70 | 20 | 1 |
| 54024S | 82,00 | 24 | 1 |
| 54028S | 95,50 | 28 | 1 |
| 54032S | 119,50 | 32 | 1 |
| 54036S | 144,90 | 36 | 1 |
| 54040S | 193,80 | 40 | 1 |
| 54045S | 232,00 | 45 | 1 |
| * 54050S | 293,90 | 50 | 1 |

* **NO inducción** · NON induction · NOT Induction



Cacerola alta con tapa

Braisiere avec couvercle · Fleischtopf mit Deckel
Deep casserole with lid · Caçarola alta com tampa

| Ref | € | Ø (cm) | h(cm) | e (mm) | L | U.Venta |
|---------|--------|--------|-------|--------|-------|---------|
| 54021 | 89,40 | 20 | 13,0 | 1,5 | 4,00 | 1 |
| 54025 | 111,30 | 24 | 14,0 | 1,5 | 6,70 | 1 |
| 54029 | 135,50 | 28 | 17,5 | 1,5 | 10,70 | 1 |
| 54033 | 158,30 | 32 | 18,0 | 1,5 | 14,60 | 1 |
| 54037 | 201,90 | 36 | 21,5 | 1,5 | 21,80 | 1 |
| 54041 | 262,80 | 40 | 24,5 | 2,0 | 30,00 | 1 |
| 54046 | 311,90 | 45 | 27,5 | 2,0 | 43,70 | 1 |
| * 54051 | 411,50 | 50 | 30,0 | 2,0 | 58,80 | 1 |

* **NO inducción** · NON induction · NOT Induction



Olla recta con tapa

Marmite traiteur avec couvercle · Suppentopf mit Deckel
Casserole with lid · Caçarola com tampa

| Ref | € | Ø (cm) | h(cm) | e (mm) | L | U.Venta |
|---------|--------|--------|-------|--------|-------|---------|
| 54120 | 99,10 | 20 | 20,0 | 1,5 | 6,20 | 1 |
| 54124 | 120,90 | 24 | 24,0 | 1,5 | 10,50 | 1 |
| 54128 | 146,00 | 28 | 28,0 | 1,5 | 17,20 | 1 |
| 54132 | 198,10 | 32 | 32,0 | 1,5 | 25,70 | 1 |
| 54136 | 245,10 | 36 | 36,0 | 1,5 | 36,50 | 1 |
| 54140 | 305,40 | 40 | 40,0 | 2,0 | 50,00 | 1 |
| 54145 | 390,80 | 45 | 45,0 | 2,0 | 71,50 | 1 |
| * 54150 | 551,90 | 50 | 50,0 | 2,0 | 98,00 | 1 |

* **NO inducción** · NON induction · NOT Induction



Olla baja con tapa

Marmite basse avec couvercle · Gemüsetopf mit Deckel
Low casserole with lid · Caçarola baixa com tampa

| Ref | € | Ø (cm) | h(cm) | e (mm) | L | U.Venta |
|-------|--------|--------|-------|--------|-------|---------|
| 54119 | 93,30 | 20 | 15,0 | 1,5 | 4,70 | 1 |
| 54123 | 113,60 | 24 | 20,0 | 1,5 | 9,00 | 1 |
| 54127 | 142,00 | 28 | 22,0 | 1,5 | 13,50 | 1 |
| 54131 | 186,10 | 32 | 26,0 | 1,5 | 20,00 | 1 |
| 54135 | 209,30 | 36 | 29,0 | 1,5 | 29,50 | 1 |
| 54139 | 285,80 | 40 | 32,0 | 2,0 | 40,00 | 1 |



Cacerola alta sin tapa

Braisiere sans couvercle · Fleischtopf ohne Deckel
Deep casserole without lid · Caçarola alta sem tampa

| Ref | € | Ø (cm) | U.Venta |
|----------|--------|--------|---------|
| 54021S | 71,50 | 20 | 1 |
| 54025S | 90,80 | 24 | 1 |
| 54029S | 112,20 | 28 | 1 |
| 54033S | 129,70 | 32 | 1 |
| 54037S | 167,30 | 36 | 1 |
| 54041S | 223,80 | 40 | 1 |
| 54046S | 267,10 | 45 | 1 |
| * 54051S | 358,30 | 50 | 1 |

* **NO inducción** · NON induction · NOT Induction



Olla recta sin tapa

Marmite traiteur s/couvercle · Suppentopf ohne Deckel
Stock Pot without lid · Panela sem tampa

| Ref | € | Ø (cm) | U.Venta |
|----------|--------|--------|---------|
| 54120S | 81,20 | 20 | 1 |
| 54124S | 100,40 | 24 | 1 |
| 54128S | 122,70 | 28 | 1 |
| 54132S | 169,50 | 32 | 1 |
| 54136S | 210,50 | 36 | 1 |
| 54140S | 266,40 | 40 | 1 |
| 54145S | 346,00 | 45 | 1 |
| * 54150S | 498,70 | 50 | 1 |

* **NO inducción** · NON induction · NOT Induction



Olla baja sin tapa

Marmite basse s/couvercle · Gemüsetopf ohne Deckel
Low stock pot without lid · Panela baixa sem tampa

| Ref | € | Ø (cm) | U.Venta |
|--------|--------|--------|---------|
| 54119S | 75,40 | 20 | 1 |
| 54123S | 93,10 | 24 | 1 |
| 54127S | 118,70 | 28 | 1 |
| 54131S | 157,50 | 32 | 1 |
| 54135S | 174,70 | 36 | 1 |
| 54139S | 246,80 | 40 | 1 |



Paellera con tapa

Plat rond avec couvercle · Pfanne mit Deckel
Round dish with lid · Paelheira com tampa

| Ref | € | Ø (cm) | h(cm) | e (mm) | L | U.Venta |
|---------|---------------|--------|-------|--------|-------|---------|
| 54636 | 174,10 | 36 | 7,0 | 1,5 | 7,00 | 1 |
| 54640 | 211,90 | 40 | 8,0 | 1,5 | 10,00 | 1 |
| 54645 | 245,40 | 45 | 8,5 | 2,0 | 12,00 | 1 |
| * 54650 | 309,70 | 50 | 9,0 | 2,0 | 17,00 | 1 |

* **NO inducción** · NON induction · NOT Induction



Paellera sin tapa

Plat rond s/couvercle · Pfanne ohne Deckel
Round dish without lid · Paelheira sem tampa

| Ref | € | Ø (cm) | U.Venta |
|----------|---------------|--------|---------|
| 54636S | 137,80 | 36 | 1 |
| 54640S | 170,80 | 40 | 1 |
| 54645S | 198,30 | 45 | 1 |
| * 54650S | 253,50 | 50 | 1 |

* **NO inducción** · NON induction · NOT Induction



Cazo

Casserole · Stielkasserolle, flach
Saucepan · Caçarola direite

| Ref | € | Ø (cm) | h(cm) | e (mm) | L | U.Venta |
|---------|--------------|--------|-------|--------|------|---------|
| 54212 | 44,20 | 12 | 7,0 | 1,2 | 0,75 | 1 |
| 54214 | 46,70 | 14 | 7,5 | 1,2 | 1,10 | 1 |
| 54216 | 49,40 | 16 | 8,0 | 1,5 | 1,60 | 1 |
| 54218 | 54,10 | 18 | 9,0 | 1,5 | 2,25 | 1 |
| 54220 | 60,70 | 20 | 10,0 | 1,5 | 2,90 | 1 |
| * 54224 | 79,90 | 24 | 10,0 | 1,5 | 4,25 | 1 |
| * 54228 | 92,40 | 28 | 11,0 | 1,5 | 6,70 | 1 |

* **Con asa** · Avec poignée · With handle



Cazo alto

Casserole haute · Stielkasserolle
Deep saucepan · Caçarola alta direite

| Ref | € | Ø (cm) | h(cm) | e (mm) | L | U.Venta |
|---------|---------------|--------|-------|--------|-------|---------|
| 54217 | 52,00 | 16 | 11,0 | 1,5 | 2,20 | 1 |
| 54219 | 60,80 | 18 | 12,0 | 1,5 | 3,00 | 1 |
| 54221 | 64,10 | 20 | 13,0 | 1,5 | 4,00 | 1 |
| * 54225 | 91,50 | 24 | 14,0 | 1,5 | 6,70 | 1 |
| * 54229 | 107,80 | 28 | 17,5 | 1,5 | 10,70 | 1 |

* **Con asa** · Avec poignée · With handle



Cazo Francés

Casserole Française · Stielkasserolle, französisch
French saucepan · Francês caçarola direite

| Ref | € | Ø (cm) | h(cm) | e (mm) | L | U.Venta |
|--------|---------------|--------|-------|--------|------|---------|
| 54225N | 78,40 | 24 | 12,0 | 1,5 | 5,40 | 1 |
| 54229N | 100,60 | 28 | 14,0 | 1,5 | 8,60 | 1 |



Cazo Cónico

Sautase conique · Sauteuse, Konisch
Conical saute pan · Caçarola cónica

| Ref | € | Ø (cm) | h(cm) | e (mm) | L | U.Venta |
|-------|--------------|--------|-------|--------|------|---------|
| 55216 | 49,40 | 16 | 6,0 | 1,5 | 1,00 | 1 |
| 55220 | 54,50 | 20 | 6,5 | 1,5 | 1,60 | 1 |
| 55224 | 63,80 | 24 | 7,5 | 1,5 | 2,70 | 1 |

Tapa

Couvercle · Deckel
Lid · Tampa

| Ref | € | Ø (cm) | U.Venta |
|-------|--------------|--------|---------|
| 54916 | 16,50 | 16 | 1 |
| 54920 | 17,90 | 20 | 1 |
| 54924 | 20,50 | 24 | 1 |
| 54928 | 23,30 | 28 | 1 |
| 54932 | 28,60 | 32 | 1 |
| 54936 | 34,60 | 36 | 1 |
| 54940 | 39,00 | 40 | 1 |
| 54945 | 44,80 | 45 | 1 |
| 54950 | 53,20 | 50 | 1 |



Sautex

Sauteuse · Sauteuse
Sauté pan · Frigideira

| Ref | € | Ø (cm) | h(cm) | e (mm) | L | U.Venta |
|---------|---------------|--------|-------|--------|------|---------|
| * 54621 | 59,00 | 20 | 6,5 | 1,5 | 1,80 | 1 |
| 54625 | 71,50 | 24 | 6,5 | 1,5 | 2,70 | 1 |
| 54629 | 87,90 | 28 | 7,0 | 1,5 | 4,00 | 1 |
| 54633 | 110,10 | 32 | 8,5 | 1,5 | 4,70 | 1 |
| 54637 | 132,70 | 36 | 10,0 | 1,5 | 7,00 | 1 |

* **Sin asa** · Sans poignée · Without handle



Chef Classic

INOX 18/10
Sandwich Induction Vitro Electric Gas Oven Dishwasher

- **Toda la pieza (cuerpo, asas y mangos) fabricada en acero inoxidable 18/10.**
- **Fondo termodifusor (inox 18/10 - aluminio - inox).**
- **Espesor 0,7 - 1,2 mm.**
- **Tapas diseñadas para el ahorro energético.**
- **Apta para todos los tipos de cocina (incluida inducción y horno). * Excepto Ø60 cm.**
- **Acabado mate interior y exterior.**
- **Máxima garantía en cuanto a resistencia, durabilidad e higiene.**

- Toute la pièce (corps, poignées et manches) est fabriquée en acier inoxydable 18/10.
- Fond thermo-diffuseur (Inox 18/10 - Aluminium - Inox).
- Épaisseur 0,7 - 1,2 mm.
- Couvercles conçus pour une économie d'énergie.
- Compatible avec tous les types de cuisinières (et compris induction et four). * Excepté Ø60 cm.
- Finition mate intérieur et extérieur.
- Garantie maximale en termes de résistance, de durabilité et d'hygiène.

- The whole product (body, handles and grips) is made in 18/10 stainless steel.
- Heat diffuser bottom (18/10 stainless steel - Aluminium - Stainless).
- Thickness 0.7 - 1.2 mm.
- Covers designed for saving energy.
- Suitable for all types of cooking surfaces (including induction and the oven). * Except Ø60 cm.
- Interior and exterior matte finish.
- Maximum guarantee in terms of resistance, durability and hygiene.



Cacerola con tapa

Faitout avec couvercle · Bratentopf mit Deckel
Casserole with lid · Caçarola com tampa

| Ref | € | Ø (cm) | h(cm) | e (mm) | L | U.Venta |
|---------|---------------|--------|-------|--------|-------|---------|
| 50016 | 51,00 | 16 | 8,0 | 0,7 | 1,60 | 1 |
| 50020 | 60,70 | 20 | 9,0 | 0,7 | 2,80 | 1 |
| 50024 | 68,90 | 24 | 9,5 | 0,8 | 4,25 | 1 |
| 50028 | 95,40 | 28 | 11,0 | 0,8 | 6,75 | 1 |
| 50032 | 119,40 | 32 | 12,5 | 0,8 | 10,00 | 1 |
| 50036 | 159,90 | 36 | 14,0 | 1,0 | 14,20 | 1 |
| 50040 | 185,10 | 40 | 15,5 | 1,0 | 19,40 | 1 |
| 50045 | 218,10 | 45 | 17,0 | 1,0 | 27,00 | 1 |
| 50050 | 302,60 | 50 | 20,0 | 1,0 | 38,20 | 1 |
| * 50060 | 431,10 | 60 | 25,0 | 1,2 | 70,00 | 1 |

* **NO inducción** · NON induction · NOT Induction



Cacerola sin tapa

Faitout sans couvercle · Bratentopf ohne Deckel
Casserole without lid · Caçarola sem tampa

| Ref | € | Ø (cm) | U.Venta |
|----------|---------------|--------|---------|
| 50016S | 40,40 | 16 | 1 |
| 50020S | 46,80 | 20 | 1 |
| 50024S | 53,70 | 24 | 1 |
| 50028S | 78,00 | 28 | 1 |
| 50032S | 96,40 | 32 | 1 |
| 50036S | 132,10 | 36 | 1 |
| 50040S | 153,90 | 40 | 1 |
| 50045S | 180,80 | 45 | 1 |
| 50050S | 256,80 | 50 | 1 |
| * 50060S | 371,30 | 60 | 1 |

* **NO inducción** · NON induction · NOT Induction



Cacerola alta con tapa

Braisiere avec couvercle · Fleischtopf mit Deckel
Deep casserole with lid · Caçarola alta com tampa

| Ref | € | Ø (cm) | h(cm) | e (mm) | L | U.Venta |
|---------|--------|--------|-------|--------|-------|---------|
| 50017 | 52,80 | 16 | 11,0 | 0,7 | 2,20 | 1 |
| 50021 | 65,30 | 20 | 13,0 | 0,7 | 4,00 | 1 |
| 50025 | 76,70 | 24 | 14,0 | 0,8 | 6,75 | 1 |
| 50029 | 99,10 | 28 | 17,5 | 0,8 | 10,00 | 1 |
| 50033 | 129,70 | 32 | 18,0 | 0,8 | 14,40 | 1 |
| 50037 | 174,30 | 36 | 21,5 | 1,0 | 21,80 | 1 |
| 50041 | 208,80 | 40 | 24,5 | 1,0 | 30,70 | 1 |
| 50046 | 243,10 | 45 | 27,5 | 1,0 | 43,70 | 1 |
| 50051 | 348,50 | 50 | 30,0 | 1,2 | 58,80 | 1 |
| * 50061 | 490,40 | 60 | 35,0 | 1,2 | 98,00 | 1 |

* NO inducción · NON induction · NOT Induction



Cacerola alta sin tapa

Braisiere sans couvercle · Fleischtopf ohne Deckel
Deep casserole without lid · Caçarola alta sem tampa

| Ref | € | Ø (cm) | U.Venta |
|----------|--------|--------|---------|
| 50017S | 42,20 | 16 | 1 |
| 50021S | 51,40 | 20 | 1 |
| 50025S | 61,50 | 24 | 1 |
| 50029S | 81,70 | 28 | 1 |
| 50033S | 106,70 | 32 | 1 |
| 50037S | 146,50 | 36 | 1 |
| 50041S | 177,60 | 40 | 1 |
| 50046S | 205,80 | 45 | 1 |
| 50051S | 302,70 | 50 | 1 |
| * 50061S | 430,60 | 60 | 1 |

* NO inducción · NON induction · NOT Induction



Paellera con tapa

Plat rond a/couvercle · Pfanne mit Deckel
Round with lid · Paelheira com tampa

| Ref | € | Ø (cm) | h(cm) | e (mm) | L | U.Venta |
|---------|--------|--------|-------|--------|-------|---------|
| 50624 | 64,80 | 24 | 6,0 | 0,8 | 2,70 | 1 |
| 50628 | 87,70 | 28 | 6,0 | 0,8 | 3,60 | 1 |
| 50632 | 113,20 | 32 | 6,0 | 0,8 | 5,00 | 1 |
| 50636 | 143,40 | 36 | 7,0 | 1,0 | 7,10 | 1 |
| 50640 | 165,00 | 40 | 8,0 | 1,0 | 10,00 | 1 |
| 50645 | 193,80 | 45 | 8,5 | 1,0 | 13,50 | 1 |
| 50650 | 251,40 | 50 | 9,0 | 1,0 | 17,60 | 1 |
| * 50660 | 363,40 | 60 | 9,0 | 1,0 | 25,40 | 1 |

* NO inducción · NON induction · NOT Induction



Paellera sin tapa

Plat rond s/couvercle · Pfanne ohne Deckel
Round dish without lid · Paelheira sem tampa

| Ref | € | Ø (cm) | U.Venta |
|----------|--------|--------|---------|
| 50624S | 49,60 | 24 | 1 |
| 50628S | 70,30 | 28 | 1 |
| 50632S | 90,20 | 32 | 1 |
| 50636S | 115,60 | 36 | 1 |
| 50640S | 133,80 | 40 | 1 |
| 50645S | 156,50 | 45 | 1 |
| 50650S | 205,60 | 50 | 1 |
| * 50660S | 303,60 | 60 | 1 |

* NO inducción · NON induction · NOT Induction



Olla recta con tapa

Marmite traiteur avec couvercle · Suppentopf mit Deckel
Stock pot with lid · Panela com tampa

| Ref | € | Ø (cm) | h(cm) | e (mm) | L | U.Venta |
|---------|--------|--------|-------|--------|--------|---------|
| 50116 | 56,60 | 16 | 16,0 | 0,8 | 3,20 | 1 |
| 50120 | 72,50 | 20 | 20,2 | 0,8 | 6,20 | 1 |
| 50124 | 91,00 | 24 | 24,0 | 0,8 | 10,50 | 1 |
| 50128 | 124,30 | 28 | 28,0 | 1,0 | 17,20 | 1 |
| 50132 | 176,20 | 32 | 32,0 | 1,0 | 25,70 | 1 |
| 50136 | 213,90 | 36 | 36,0 | 1,0 | 36,60 | 1 |
| 50140 | 255,60 | 40 | 40,0 | 1,2 | 50,00 | 1 |
| 50145 | 328,30 | 45 | 45,0 | 1,2 | 68,30 | 1 |
| 50150 | 514,40 | 50 | 50,0 | 1,2 | 98,00 | 1 |
| * 50160 | 722,30 | 60 | 50,0 | 1,2 | 141,00 | 1 |

* NO inducción · NON induction · NOT Induction



Olla recta sin tapa

Marmite traiteur s/couvercle · Suppentopf ohne Deckel
Stock Pot without lid · Panela sem tampa

| Ref | € | Ø (cm) | U.Venta |
|----------|--------|--------|---------|
| 50116S | 46,00 | 16 | 1 |
| 50120S | 58,60 | 20 | 1 |
| 50124S | 75,80 | 24 | 1 |
| 50128S | 106,90 | 28 | 1 |
| 50132S | 153,20 | 32 | 1 |
| 50136S | 186,10 | 36 | 1 |
| 50140S | 224,40 | 40 | 1 |
| 50145S | 291,00 | 45 | 1 |
| 50150S | 468,60 | 50 | 1 |
| * 50160S | 662,50 | 60 | 1 |

* NO inducción · NON induction · NOT Induction



Cacerola Vapor

Panier vapeur · Dampfkoch-Aussatz o/Untertopf
Steam casserole · Caçarola a vapor

| Ref | € | Ø (cm) | h(cm) | e (mm) | U.Venta |
|-------|-------|--------|-------|--------|---------|
| 50428 | 60,50 | 28 | 11,0 | 0,8 | 1 |
| 50432 | 66,80 | 32 | 12,5 | 0,8 | 1 |



Sautex

Sauteuse · Sauteuse
Sauteuse · Frigideira

| Ref | € | Ø (cm) | h(cm) | e (mm) | L | U.Venta |
|-------|--------|--------|-------|--------|------|---------|
| 50625 | 47,50 | 24 | 6,5 | 0,8 | 2,70 | 1 |
| 50629 | 65,50 | 28 | 7,0 | 0,8 | 4,00 | 1 |
| 50633 | 74,20 | 32 | 8,5 | 0,8 | 4,70 | 1 |
| 50637 | 106,90 | 36 | 10,0 | 1,0 | 7,00 | 1 |



Olla baja con tapa

Marmite basse a/couvercle · Gemüsetopf mit Deckel
Low stock pot with lid · Panela baixa com tampa

| Ref | € | Ø (cm) | h(cm) | e (mm) | L | U.Venta |
|-------|--------|--------|-------|--------|-------|---------|
| 50119 | 64,90 | 20 | 15,0 | 0,8 | 4,70 | 1 |
| 50123 | 86,50 | 24 | 20,0 | 0,8 | 9,00 | 1 |
| 50127 | 112,90 | 28 | 22,0 | 0,8 | 13,50 | 1 |
| 50131 | 164,50 | 32 | 26,0 | 1,0 | 20,80 | 1 |
| 50135 | 191,20 | 36 | 29,0 | 1,0 | 29,50 | 1 |
| 50139 | 241,00 | 40 | 32,0 | 1,2 | 40,00 | 1 |



Olla baja sin tapa

Marmite basse s/couvercle · Gemüsetopf ohne Deckel
Low stock pot without lid · Panela baixa sem tampa

| Ref | € | Ø (cm) | U.Venta |
|--------|--------|--------|---------|
| 50119S | 51,00 | 20 | 1 |
| 50123S | 71,30 | 24 | 1 |
| 50127S | 95,50 | 28 | 1 |
| 50131S | 141,50 | 32 | 1 |
| 50135S | 163,40 | 36 | 1 |
| 50139S | 209,80 | 40 | 1 |



Cazo

Casserole · Stielkasserolle, flach
Saucepan · Caçarola direite

| Ref | € | Ø (cm) | h(cm) | e (mm) | L | U.Venta |
|-------|-------|--------|-------|--------|------|---------|
| 50212 | 28,10 | 12 | 7,0 | 0,7 | 0,75 | 1 |
| 50214 | 30,30 | 14 | 7,5 | 0,7 | 1,10 | 1 |
| 50216 | 33,30 | 16 | 8,0 | 0,8 | 1,60 | 1 |
| 50218 | 36,00 | 18 | 9,0 | 0,8 | 2,20 | 1 |
| 50220 | 39,80 | 20 | 9,0 | 0,8 | 2,80 | 1 |
| 50224 | 49,00 | 24 | 9,5 | 0,8 | 4,25 | 1 |
| 50228 | 68,70 | 28 | 11,0 | 0,8 | 6,75 | 1 |



Cazo alto

Casserole haute · Stielkasserolle, hoch
Deep saucepan · Caçarola alta direite

| Ref | € | Ø (cm) | h(cm) | e (mm) | L | U.Venta |
|-------|-------|--------|-------|--------|-------|---------|
| 50217 | 35,50 | 16 | 11,0 | 0,8 | 2,10 | 1 |
| 50219 | 41,20 | 18 | 12,0 | 0,8 | 3,00 | 1 |
| 50221 | 46,40 | 20 | 13,0 | 0,8 | 4,00 | 1 |
| 50225 | 56,60 | 24 | 14,0 | 0,8 | 6,30 | 1 |
| 50229 | 77,00 | 28 | 17,5 | 0,8 | 10,20 | 1 |



Cazo Francés

Casserole Française · Stielkasserolle, französisch
French saucepan · Francês caçarola direita

| Ref | € | Ø (cm) | h(cm) | e (mm) | L | U.Venta |
|--------|-------|--------|-------|--------|------|---------|
| 50225N | 54,30 | 24 | 12,0 | 0,8 | 5,50 | 1 |
| 50229N | 70,40 | 28 | 14,0 | 0,8 | 8,50 | 1 |



Cazo Cónico

Sautase conique · Sauteuse, Konisch
Conical saute pan · Caçarola cónica

| Ref | € | Ø (cm) | h(cm) | e (mm) | L | U.Venta |
|-------|-------|--------|-------|--------|------|---------|
| 51216 | 40,40 | 16 | 6,0 | 1,0 | 1,00 | 1 |
| 51218 | 42,50 | 18 | 6,0 | 1,0 | 1,20 | 1 |
| 51220 | 44,40 | 20 | 6,5 | 1,0 | 1,60 | 1 |
| 51222 | 48,50 | 22 | 7,0 | 1,0 | 2,10 | 1 |
| 51224 | 53,10 | 24 | 7,5 | 1,0 | 2,70 | 1 |



Baño maría con fondo

Bahut avec fond · Bain Marie Topf
Double boiler with bottom · Banho-Maria com fundo

| Ref | € | Ø (cm) | h(cm) | e (mm) | L | U.Venta |
|-------|-------|--------|-------|--------|------|---------|
| 50717 | 40,90 | 16 | 16,0 | 0,8 | 3,20 | 1 |
| 50721 | 53,10 | 20 | 20,0 | 0,8 | 6,20 | 1 |



Rustidera

Couvercle · Deckel
Lid · Tampa

| Ref | € | cm | h(cm) | e (mm) | U.Venta |
|-------|--------|-------|-------|--------|---------|
| 50540 | 118,40 | 40x30 | 8,0 | 1,0 | 1 |
| 50550 | 156,80 | 50x40 | 8,0 | 1,0 | 1 |
| 50560 | 197,50 | 60x45 | 8,0 | 1,0 | 1 |
| 50570 | 225,60 | 70x45 | 9,5 | 1,0 | 1 |



Tapa

Plat à roir · Bratpfanne
Roaster · Assadeira

| Ref | € | Ø (cm) | U.Venta |
|-------|-------|--------|---------|
| 50916 | 10,60 | 16 | 1 |
| 50918 | 11,80 | 18 | 1 |
| 50920 | 13,90 | 20 | 1 |
| 50924 | 15,20 | 24 | 1 |
| 50928 | 17,40 | 28 | 1 |
| 50932 | 23,00 | 32 | 1 |
| 50936 | 27,80 | 36 | 1 |
| 50940 | 31,20 | 40 | 1 |
| 50945 | 37,30 | 45 | 1 |
| 50950 | 45,80 | 50 | 1 |
| 50960 | 59,80 | 60 | 1 |

Máxima garantía en resistencia y durabilidad
Maximum guarantee in resistance and durability



Eco Chef

INOX 18/10
Sandwich Induction Vitro Electric Gas Oven Dishwasher

- **Toda la pieza (cuerpo, asas y mangos) fabricada en acero inoxidable.**
 - **Fondo termodifusor (inox 18/10 - aluminio - inox). Espesor 0,6 - 1 mm.**
 - **Tapas diseñadas para el ahorro energético.**
 - **Apta para todos los tipos de cocina (incluida inducción y horno).**
 - **Acabado interior mate y exterior brillo-mate.**
 - **Máxima garantía en cuanto a resistencia, durabilidad e higiene.**
- Toute la pièce (corps, poignées et manches) est fabriquée en acier inoxydable.
 - Fond thermo-diffuseur (Inox 18/10 - Aluminium - Inox). Épaisseur 0,6 - 1 mm.
 - Couvercles conçus pour une économie d'énergie.
 - Compatible avec tous les types de cuisinières (y compris induction et four).
 - Finition mate intérieur et brillant-mate extérieur.
 - Garantie maximale en termes de résistance, de durabilité et d'hygiène.
- The whole product (body, handles and grips) is made in stainless steel.
 - Heat diffuser bottom (18/10 stainless steel - Aluminium - Stainless). Thickness 0.6 - 1 mm.
 - Covers designed for saving energy.
 - Suitable for all types of cooking surfaces (including induction and the oven).
 - Interior matte finish and exterior brightness-matte finish.
 - Maximum guarantee in terms of resistance, durability and hygiene.



Cacerola sin tapa

Faitout sans couvercle · Bratentopf ohne Deckel
Casserole without lid · Caçarola sem tampa

| Ref | € | Ø (cm) | h(cm) | e (mm) | L | U.Venta |
|-------|--------|--------|-------|--------|-------|---------|
| 57016 | 29,30 | 16 | 8,0 | 0,6 | 1,60 | 1 |
| 57020 | 36,00 | 20 | 9,0 | 0,6 | 2,80 | 1 |
| 57024 | 39,30 | 24 | 9,5 | 0,7 | 4,25 | 1 |
| 57028 | 62,50 | 28 | 11,0 | 0,7 | 6,75 | 1 |
| 57032 | 74,50 | 32 | 12,5 | 0,7 | 10,00 | 1 |
| 57036 | 114,80 | 36 | 14,5 | 0,7 | 14,20 | 1 |
| 57040 | 130,80 | 40 | 15,5 | 0,9 | 19,40 | 1 |



Cacerola alta sin tapa

Braisiere sans couvercle · Fleischtopf ohne Deckel
Deep casserole without lid · Caçarola alta sem tampa

| Ref | € | Ø (cm) | h(cm) | e (mm) | L | U.Venta |
|-------|--------|--------|-------|--------|-------|---------|
| 57017 | 31,20 | 16 | 11,0 | 0,6 | 2,20 | 1 |
| 57021 | 37,90 | 20 | 13,0 | 0,6 | 4,00 | 1 |
| 57025 | 46,40 | 24 | 15,0 | 0,7 | 7,00 | 1 |
| 57029 | 68,30 | 28 | 17,5 | 0,7 | 10,00 | 1 |
| 57033 | 82,60 | 32 | 18,0 | 0,7 | 14,40 | 1 |
| 57037 | 125,90 | 36 | 21,5 | 0,9 | 21,80 | 1 |
| 57041 | 154,50 | 40 | 24,5 | 0,9 | 30,70 | 1 |



Olla recta sin tapa

Marmite traiteur sans couvercle · Suppentopf ohne Deckel
Stock pot without lid · Panela sem tampa

| Ref | € | Ø (cm) | h (cm) | e (mm) | L | U.Venta |
|-------|--------|--------|--------|--------|-------|---------|
| 57116 | 35,60 | 16 | 16,0 | 0,7 | 3,20 | 1 |
| 57120 | 41,70 | 20 | 20,0 | 0,7 | 6,20 | 1 |
| 57124 | 58,70 | 24 | 24,0 | 0,7 | 10,50 | 1 |
| 57128 | 86,50 | 28 | 25,5 | 0,9 | 16,50 | 1 |
| 57132 | 129,60 | 32 | 32,0 | 0,9 | 25,70 | 1 |
| 57136 | 162,80 | 36 | 36,0 | 0,9 | 36,60 | 1 |
| 57140 | 200,40 | 40 | 40,0 | 1,0 | 50,00 | 1 |



Cazo

Casserole · Stielkasserolle, flach
Saucepan · Caçarola direite

| Ref | € | Ø (cm) | h (cm) | e (mm) | L | U.Venta |
|-------|-------|--------|--------|--------|------|---------|
| 57212 | 22,20 | 12 | 7,0 | 0,6 | 0,75 | 1 |
| 57214 | 23,70 | 14 | 7,5 | 0,6 | 1,10 | 1 |
| 57216 | 25,20 | 16 | 8,0 | 0,6 | 1,60 | 1 |
| 57218 | 27,70 | 18 | 8,5 | 0,6 | 2,00 | 1 |
| 57220 | 31,00 | 20 | 9,0 | 0,6 | 2,80 | 1 |
| 57224 | 40,00 | 24 | 9,5 | 0,7 | 4,25 | 1 |



Cazo alto

Casserole haute · Stielkasserolle, hoch
Deep saucepan · Caçarola alta direite

| Ref | € | Ø (cm) | h (cm) | e (mm) | L | U.Venta |
|-------|-------|--------|--------|--------|------|---------|
| 57217 | 27,70 | 16 | 11,0 | 0,6 | 2,10 | 1 |
| 57219 | 32,30 | 18 | 12,0 | 0,6 | 3,00 | 1 |
| 57221 | 36,60 | 20 | 13,0 | 0,6 | 4,00 | 1 |
| 57225 | 50,30 | 24 | 15,0 | 0,7 | 6,50 | 1 |



Baño maría con fondo

Bahut avec fond · Bain marie Topf
Double boiler with bottom · Banho-Maria com fundo

| Ref | € | Ø (cm) | h (cm) | e (mm) | L | U.Venta |
|-------|-------|--------|--------|--------|------|---------|
| 57717 | 32,60 | 16 | 16,0 | 0,7 | 3,20 | 1 |
| 57721 | 43,70 | 20 | 20,0 | 0,7 | 6,20 | 1 |



Sautex

Sauteuse · Sauteuse
Sauteuse · Frigideira

| Ref | € | Ø (cm) | h (cm) | e (mm) | L | U.Venta |
|-------|-------|--------|--------|--------|------|---------|
| 57625 | 36,60 | 24 | 6,5 | 0,7 | 2,70 | 1 |
| 57629 | 55,40 | 28 | 6,5 | 0,7 | 4,00 | 1 |

Gastro Garinox



- **Batería Gastro de Garinox.**
- **Toda la pieza (cuerpo, asas y mangos) fabricada en acero inoxidable.**
- **Espesor de 0,6mm.**
- **Fondo termodifusor (inox 18/10 - aluminio - inox).**
- **Tapas diseñadas para el ahorro energético.**
- **Apta para todos los tipos de cocina (incluida inducción y horno).**
- **Máxima garantía en cuanto a resistencia, durabilidad e higiene.**

- Batterie de cuisine Garinox Gastro.
- L'ensemble de la pièce (corps, poignées et manches) est en acier inoxydable.
- Epaisseur de 0,6 mm.
- Fond thermodiffuseur (acier inoxydable 18/10 - aluminium - acier inoxydable).
- Couvercles conçus pour économiser l'énergie.
- Convient à tous les types de cuisinières (y compris induction et four).
- Garantie maximale en termes de résistance, de durabilité et d'hygiène.

- Garinox Gastro cookware.
- The whole piece (body, handles and grips) is made of stainless steel.
- Thickness of 0,6mm.
- Thermo-diffuser bottom (18/10 stainless steel - aluminium - stainless steel).
- Lids designed for energy saving.
- Suitable for all types of cookers (including induction and oven).
- Maximum guarantee in terms of resistance, durability and hygiene.



Cacerola sin tapa

Faitout sans couvercle · Bratentopf ohne Deckel
Casserole without lid · Caçarola sem tampa

| Ref | € | Ø (cm) | h (cm) | L | U.Venta |
|-------|--------|--------|--------|-------|---------|
| 16020 | 29,40 | 20 | 9,0 | 2,75 | 1 |
| 16024 | 32,40 | 24 | 9,5 | 4,20 | 1 |
| 16028 | 42,90 | 28 | 11,0 | 6,70 | 1 |
| 16032 | 54,30 | 32 | 12,5 | 10,00 | 1 |
| 16036 | 82,80 | 36 | 14,5 | 14,70 | 1 |
| 16040 | 104,40 | 40 | 15,5 | 19,50 | 1 |



Olla recta sin tapa

Marmite traiteur s/couvercle · Suppentopf ohne Deckel
Stock Pot without lid · Panela sem tampa

| Ref | € | Ø (cm) | h (cm) | L | U.Venta |
|-------|--------|--------|--------|------|---------|
| 16120 | 38,50 | 20 | 20,0 | 6,2 | 1 |
| 16124 | 48,90 | 24 | 24,0 | 10,8 | 1 |
| 16128 | 60,20 | 28 | 25,5 | 15,5 | 1 |
| 16132 | 93,10 | 32 | 32,0 | 25,5 | 1 |
| 16136 | 117,70 | 36 | 36,0 | 36,5 | 1 |
| 16140 | 151,00 | 40 | 40,0 | 50,0 | 1 |



Paellera sin tapa

Plat rond s/couvercle · Pfanne ohne Deckel
Round dish without lid · Paelheira sem tampa

| Ref | € | Ø (cm) | h (cm) | L | U.Venta |
|-------|-------|--------|--------|------|---------|
| 16624 | 32,20 | 24 | 6,5 | 2,8 | 1 |
| 16628 | 40,00 | 28 | 6,5 | 4,0 | 1 |
| 16632 | 49,50 | 32 | 7,0 | 5,5 | 1 |
| 16636 | 66,80 | 36 | 7,0 | 7,0 | 1 |
| 16640 | 92,10 | 40 | 8,0 | 10,0 | 1 |

garinox®

new



Cacerola alta sin tapa

Braisiere sans couvercle · Fleischtopf ohne Deckel
Deep casserole without lid · Caçarola alta sem tampa

| Ref | € | Ø (cm) | h (cm) | L | U.Venta |
|-------|--------|--------|--------|-------|---------|
| 16021 | 30,70 | 20 | 13,0 | 4,00 | 1 |
| 16025 | 38,60 | 24 | 15,0 | 6,70 | 1 |
| 16029 | 48,00 | 28 | 17,5 | 10,70 | 1 |
| 16033 | 63,40 | 32 | 18,0 | 14,50 | 1 |
| 16037 | 94,20 | 36 | 21,5 | 21,80 | 1 |
| 16041 | 118,30 | 40 | 24,5 | 30,70 | 1 |



Cazo

Casserole · Stielkasserolle, flach
Saucepan · Caçarola direite

| Ref | € | Ø (cm) | h (cm) | L | U.Venta |
|-------|-------|--------|--------|------|---------|
| 16212 | 15,90 | 12 | 7,0 | 0,75 | 1 |
| 16214 | 17,10 | 14 | 7,5 | 1,00 | 1 |
| 16216 | 18,60 | 16 | 8,0 | 1,50 | 1 |
| 16218 | 21,20 | 18 | 8,0 | 2,00 | 1 |
| 16220 | 23,80 | 20 | 9,0 | 2,75 | 1 |
| 16224 | 29,80 | 24 | 9,5 | 4,20 | 1 |



Tapa

Couvercle · Deckel
Lid · Tampa

| Ref | € | Ø (cm) | U.Venta |
|-------|-------|--------|---------|
| 16920 | 8,30 | 20 | 1 |
| 16924 | 9,40 | 24 | 1 |
| 16928 | 11,30 | 28 | 1 |
| 16932 | 15,00 | 32 | 1 |
| 16936 | 17,50 | 36 | 1 |
| 16940 | 20,20 | 40 | 1 |

Aluminio puro (99,5%)
Made in pure aluminium (99,5%)



Chef Aluminio

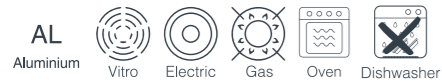

- **Cuerpo fabricado en aluminio puro (99,5%).**
- **Asas y mangos atérmicos en tubo de acero inoxidable 18/10.**
- **Tapa diseñada para el ahorro energético.**
- **Apta para todos los tipos de cocina (excepto inducción).**
- **Acabado mate interior y exterior mate lijado.**
- **Máxima garantía en cuanto a resistencia, durabilidad e higiene.**

- Corps en aluminium pur (99,5%).
- Mangoes asas et atrmon dans le tube d'acier inoxydable 18/10.
- Couverture conçue pour les économies d'énergie.
- Convient à tous les types de cuisine (sauf induction).
- Finition mate mate mate et extérieure.
- Garantie maximale en termes de résistance, de durabilité et d'hygiène.

- Body made of pure aluminum (99.5%).
- Asas and atrmon mangoes in stainless steel tube 18/10.
- Cover designed for energy savings.
- Suitable for all types of kitchen (except induction).
- Matte inner and exterior matte finish.
- Maximum guarantee in terms of resistance, durability and hygiene.



Cacerola con tapa

Braisiere a/couvercle · Bratentopf mit Deckel
Casserole with lid · Caçarola com tampa

| Ref | € | Ø (cm) | h(cm) | e (mm) | L | U.Venta |
|-------|--------|--------|-------|--------|-------|---------|
| 20020 | 50,00 | 20 | 8,0 | 2,5 | 2,50 | 1 |
| 20024 | 55,80 | 24 | 9,5 | 2,5 | 4,30 | 1 |
| 20028 | 67,20 | 28 | 11,0 | 2,5 | 6,75 | 1 |
| 20030 | 72,20 | 30 | 11,5 | 2,5 | 8,15 | 1 |
| 20032 | 77,20 | 32 | 12,0 | 2,5 | 9,65 | 1 |
| 20034 | 83,90 | 34 | 13,0 | 3,0 | 11,80 | 1 |
| 20036 | 89,10 | 36 | 14,0 | 3,0 | 14,25 | 1 |
| 20038 | 99,90 | 38 | 15,0 | 3,0 | 17,00 | 1 |
| 20040 | 105,30 | 40 | 16,0 | 3,0 | 21,10 | 1 |
| 20045 | 125,70 | 45 | 18,0 | 3,5 | 28,00 | 1 |
| 20050 | 150,40 | 50 | 21,0 | 3,5 | 41,00 | 1 |
| 20060 | 214,20 | 60 | 25,0 | 4,5 | 70,00 | 1 |

Cacerola alta con tapa

Braisiere avec couvercle · Fleischtopf mit Deckel
Deep casserole with lid · Caçarola alta com tampa

| Ref | € | Ø (cm) | h(cm) | e (mm) | L | U.Venta |
|-------|--------|--------|-------|--------|--------|---------|
| 20021 | 54,40 | 20 | 13,0 | 2,5 | 4,10 | 1 |
| 20025 | 62,50 | 24 | 15,0 | 2,5 | 6,80 | 1 |
| 20029 | 72,10 | 28 | 17,0 | 2,5 | 10,45 | 1 |
| 20031 | 78,70 | 30 | 18,0 | 2,5 | 12,70 | 1 |
| 20033 | 91,20 | 32 | 19,0 | 3,0 | 15,25 | 1 |
| 20035 | 98,30 | 34 | 21,0 | 3,0 | 18,05 | 1 |
| 20037 | 100,70 | 36 | 22,0 | 3,0 | 22,40 | 1 |
| 20039 | 109,20 | 38 | 23,0 | 3,0 | 26,10 | 1 |
| 20041 | 125,70 | 40 | 25,0 | 3,5 | 31,40 | 1 |
| 20046 | 143,70 | 45 | 28,0 | 4,5 | 45,00 | 1 |
| 20051 | 190,70 | 50 | 31,0 | 4,5 | 60,00 | 1 |
| 20061 | 252,90 | 60 | 37,0 | 4,5 | 104,00 | 1 |



Olla recta con tapa

Marmite traiteur a/couvercle · Suppentopf mit Deckel
Stock pot with lid · Panela com tampa

| Ref | € | Ø (cm) | h(cm) | e (mm) | L | U.Venta |
|-------|--------|--------|-------|--------|--------|---------|
| 20120 | 61,90 | 20 | 20,0 | 2,5 | 6,30 | 1 |
| 20124 | 72,20 | 24 | 24,0 | 2,5 | 10,85 | 1 |
| 20128 | 90,80 | 28 | 28,0 | 3,0 | 17,25 | 1 |
| 20130 | 99,40 | 30 | 30,0 | 3,0 | 21,20 | 1 |
| 20132 | 109,40 | 32 | 32,0 | 3,0 | 25,75 | 1 |
| 20134 | 121,00 | 34 | 34,0 | 3,5 | 30,90 | 1 |
| 20136 | 130,20 | 36 | 36,0 | 3,5 | 36,65 | 1 |
| 20138 | 139,20 | 38 | 38,0 | 3,5 | 43,10 | 1 |
| 20140 | 156,10 | 40 | 40,0 | 4,0 | 50,30 | 1 |
| 20145 | 192,50 | 45 | 45,0 | 4,5 | 72,00 | 1 |
| 20150 | 216,90 | 50 | 50,0 | 4,5 | 100,00 | 1 |
| 20160 | 316,30 | 60 | 55,0 | 5,0 | 155,50 | 1 |



Paellera

Plat rond · Pfanne
Round · Paelheira

| Ref | € | Ø (cm) | h(cm) | e (mm) | L | U.Venta |
|-------|--------|--------|-------|--------|-------|---------|
| 20628 | 42,90 | 28 | 7,0 | 2,5 | 4,30 | 1 |
| 20630 | 45,60 | 30 | 6,5 | 2,5 | 4,75 | 1 |
| 20632 | 48,80 | 32 | 7,0 | 2,5 | 5,50 | 1 |
| 20634 | 51,60 | 34 | 7,0 | 2,5 | 6,35 | 1 |
| 20636 | 54,50 | 36 | 7,5 | 2,5 | 7,45 | 1 |
| 20638 | 55,40 | 38 | 7,5 | 3,0 | 8,60 | 1 |
| 20640 | 65,10 | 40 | 8,0 | 3,0 | 10,05 | 1 |
| 20645 | 71,20 | 45 | 8,0 | 3,0 | 12,50 | 1 |
| 20650 | 83,00 | 50 | 8,0 | 3,0 | 15,50 | 1 |
| 20660 | 118,70 | 60 | 10,0 | 3,5 | 28,00 | 1 |



Cazo

Casserole · Stielkasserolle, flach
Saucepan · Caçarola direite

| Ref | € | Ø (cm) | h(cm) | e (mm) | L | U.Venta |
|-------|-------|--------|-------|--------|------|---------|
| 20216 | 27,90 | 16 | 7,0 | 2,5 | 1,40 | 1 |
| 20220 | 33,40 | 20 | 8,0 | 2,5 | 2,50 | 1 |
| 20224 | 38,00 | 24 | 9,5 | 2,5 | 4,30 | 1 |
| 20228 | 45,10 | 28 | 11,0 | 2,5 | 6,80 | 1 |



Cazo alto

Casserole haute · Stielkasserolle, hoch
Deep saucepan · Caçarola alta direite

| Ref | € | Ø (cm) | h(cm) | e (mm) | L | U.Venta |
|-------|-------|--------|-------|--------|-------|---------|
| 20217 | 33,00 | 16 | 11,0 | 2,5 | 2,20 | 1 |
| 20221 | 38,30 | 20 | 13,0 | 2,5 | 4,10 | 1 |
| 20225 | 44,60 | 24 | 15,0 | 2,5 | 6,80 | 1 |
| 20229 | 51,60 | 28 | 17,0 | 2,5 | 10,50 | 1 |



Cazo Bombado

Casserole bombée · Kasserolle, Bauchig
Rounded saucepan · Caçarola bojuda

| Ref | € | Ø (cm) | h(cm) | e (mm) | L | U.Venta |
|-------|-------|--------|-------|--------|------|---------|
| 21216 | 28,10 | 16 | 8,0 | 2,5 | 1,50 | 1 |
| 21220 | 33,70 | 20 | 10,0 | 2,5 | 2,50 | 1 |
| 21224 | 39,90 | 24 | 12,0 | 2,5 | 4,00 | 1 |
| 21228 | 47,10 | 28 | 14,0 | 2,5 | 6,50 | 1 |



Pote cilíndrico

Pot-cilindrique · Milchtopf
Cylindrical pot · Caneca cilíndrica

| Ref | € | Ø (cm) | h(cm) | e (mm) | L | U.Venta |
|-------|-------|--------|-------|--------|------|---------|
| 20716 | 35,40 | 16 | 16,0 | 2,5 | 3,20 | 1 |
| 20720 | 41,60 | 20 | 20,0 | 2,5 | 6,30 | 1 |



Rustidera con asas fijas

Plat à rotir anse fixe · Bratpfanne, m. festehenden Griffen
Roaster fix handle · Assadeira com asa fixa

| Ref | € | cm | h(cm) | e (mm) | L | U.Venta |
|--------|--------|-------|-------|--------|-------|---------|
| 20540F | 55,40 | 40x30 | 6,2 | 2,5 | 7,45 | 1 |
| 20545F | 59,40 | 45x32 | 6,2 | 2,5 | 10,40 | 1 |
| 20550F | 74,60 | 50x35 | 7,0 | 3,0 | 12,60 | 1 |
| 20555F | 81,00 | 55x37 | 7,7 | 3,0 | 16,30 | 1 |
| 20560F | 87,60 | 60x40 | 7,7 | 3,0 | 18,95 | 1 |
| 20565F | 97,40 | 65x43 | 7,9 | 3,0 | 24,30 | 1 |
| 20570F | 103,00 | 70x45 | 9,0 | 3,0 | 28,65 | 1 |



Rustidera con asas abatibles

Plat à rotir anse tombante · Bratpfanne mit Fallgriffen
Roaster moving handle · Assadeira com asa abatível

| Ref | € | cm | h(cm) | e (mm) | L | U.Venta |
|--------|--------|-------|-------|--------|-------|---------|
| 20540A | 55,40 | 40x30 | 6,2 | 2,5 | 7,45 | 1 |
| 20545A | 59,40 | 45x32 | 6,2 | 2,5 | 10,40 | 1 |
| 20550A | 74,60 | 50x35 | 7,0 | 3,0 | 12,60 | 1 |
| 20555A | 81,00 | 55x37 | 7,7 | 3,0 | 16,30 | 1 |
| 20560A | 87,00 | 60x40 | 7,7 | 3,0 | 18,95 | 1 |
| 20565A | 97,40 | 65x43 | 7,9 | 3,0 | 24,30 | 1 |
| 20570A | 103,00 | 70x45 | 9,0 | 3,0 | 28,65 | 1 |



Hervidor de pescado

Poissonnière avec grille · Fischkessel mit Einsatz
Fish kettle with grill and lid · Peixeira

| Ref | € | cm | h(cm) | e (mm) | L | U.Venta |
|-------|--------|-------|-------|--------|------|---------|
| 20470 | 209,40 | 70x22 | 20,80 | 2,5 | 14,0 | 1 |



Bandeja horno

Plaque à four · Backblech
Oven tray · Bandeja forno

| Ref | € | cm | h(cm) | e (mm) | U.Venta |
|-------|-------|-------|-------|--------|---------|
| 20551 | 41,60 | 50x35 | 2,0 | 2,5 | 1 |
| 20561 | 50,70 | 60x40 | 2,0 | 2,5 | 1 |



Tapa

Couvercle · Deckel
Lid · Tampa

| Ref | € | Ø (cm) | U.Venta |
|-------|-------|--------|---------|
| 20920 | 14,90 | 20 | 1 |
| 20924 | 15,90 | 24 | 1 |
| 20928 | 19,30 | 28 | 1 |
| 20930 | 20,10 | 30 | 1 |
| 20932 | 22,30 | 32 | 1 |
| 20934 | 22,80 | 34 | 1 |
| 20936 | 24,40 | 36 | 1 |
| 20938 | 25,50 | 38 | 1 |
| 20940 | 28,40 | 40 | 1 |
| 20945 | 30,90 | 45 | 1 |
| 20950 | 36,80 | 50 | 1 |
| 20960 | 43,40 | 60 | 1 |

Baterias domésticas

Household cookware



Combi Collection



- Fabricadas en acero inoxidable 18/10 de la mejor calidad.
- Máxima garantía en cuanto a resistencia, durabilidad e higiene.
- Acabado interior y exterior lijado satinado.
- Antiadherente QuanTanium® reforzado con partículas de titanio; libre de materiales tóxicos y pesados, ecológico y libre de PFOA
- Fondo termodifusor sandwich (inox 18/10 - aluminio - inoxidable).
- Distribución rápida y uniforme del calor.
- Aptas para todos los fuegos (incluido inducción y horno).
- Asas/mangos extraíbles fabricadas en baquelita termorresistente. Disponibles en tres colores.
- Ahorra espacio de almacenaje.

- Fabriquées en acier inoxydable 18/10 de la meilleure qualité.
- Garantie maximale en termes de résistance, de durabilité et d'hygiène.
- Marquage des contenances à l'intérieur (litres).
- Finition intérieure et extérieure en polissage satiné.
- Revêtement antiadhésif QuanTanium® renforcé par des particules de titane; exempt de matériaux toxiques et lourds, respectueux de l'environnement et sans PFOA.
- Fond thermodiffuseur sandwich (inox 18/10 - aluminium - inoxydable).
- Distribution rapide et uniforme de la chaleur.
- Aptes pour tous les types de feux (y compris l'induction et le four).
- Poignées / manches amovibles fabriqué en bakélite thermo-isolante. Disponible en trois couleurs.
- Économie d'espace de stockage.

- Manufactured with the highest quality 18/10 stainless steel.
- Maximum guarantee in terms of resistance, durability and hygiene.
- Capacity markings on the inside (litres).
- Glossy sanded interior and exterior finish
- QuanTanium® non-stick reinforced with titanium particles; free from toxic and heavy materials, environmentally friendly and PFOA-free.
- Heat-diffusing sandwiched base (18/10 stainless steel - aluminium - st. Steel)
- Quick and even heat distribution.
- Suitable for all types of cookers (including induction hobs and ovens).
- Handles / grips made in heat resistant bakelite. Available in three colours.
- Saves storage space.



Apilables:
ahorra espacio de almacenamiento
Empilables:
elle permet de gagner de l'espace de rangement.
Stackable: save storage space



Sistema Click&Lock:
Mango y asas desmontables
Système Click&Lock:
Poignées et manches démontable
Click&Lock system:
Detachable handles and grips



Tapa de cristal resistente a los golpes con válvula y borde de acero inoxidable 18/10
Couvercle en verre avec soupape résistante aux chocs et bord en acier inoxydable 18/10
Glass cover with pressure valve resistant to bumps and 18/10 stainless steel rim



Cuerpo para cacerola/cazo

Corps pour faitout/casserole · Körper für Bratentopf/Stielkasserolle
Body for casserole/saucepan · Corpo para caçarola/caçarola direita

| Ref | € | Ø (cm) | h(cm) | e (mm) | L | U.Venta |
|-------|-------|--------|-------|--------|------|---------|
| 56614 | 22,10 | 14 | 7,0 | 0,8 | 1,00 | 1 |
| 56616 | 25,40 | 16 | 8,0 | 0,8 | 1,50 | 1 |
| 56618 | 29,30 | 18 | 9,0 | 0,8 | 2,00 | 1 |
| 56620 | 33,30 | 20 | 10,0 | 0,8 | 3,00 | 1 |
| 56624 | 44,90 | 24 | 12,0 | 0,8 | 5,50 | 1 |



Cuerpo para tartera/sartén

Corps pour plat rond/poêle · Körper für Pfanne/Pfanne
Body for round dish/frying pan · Corpo para tarteira/sertã

| Ref | € | Ø (cm) | h(cm) | e (mm) | L | U.Venta |
|-------|-------|--------|-------|--------|------|---------|
| 56720 | 24,30 | 20 | 4,0 | 0,8 | 1,00 | 1 |
| 56724 | 30,20 | 24 | 4,5 | 0,8 | 2,00 | 1 |
| 56728 | 41,00 | 28 | 5,0 | 0,8 | 3,00 | 1 |
| 56732 | 48,90 | 32 | 5,5 | 0,8 | 4,00 | 1 |



Set 3 cazos Combi

Ensemble 3 casseroles + poignée · Set 3 Kochtöpfe + Griff
Set 3 saucepans + handle · Conjunto de 3 panelas + pega

| Ref | € | Ø (cm) | h(cm) | e (mm) | L | U.Venta |
|-------|-------|--------|-------|--------|-----|---------|
| 56610 | 96,20 | 16 | 8,0 | 0,8 | 1,5 | 1 |

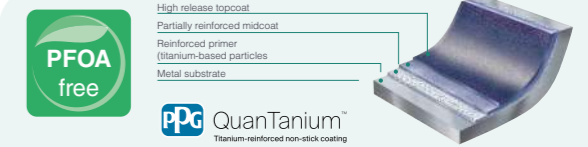

Antiadherente QuanTanium® reforzado con partículas de titanio; libre de materiales tóxicos y pesados, ecológico y libre de PFOA
QuanTanium® non-stick reinforced with titanium particles; free from toxic and heavy materials, environmentally friendly and PFOA-free.



Cuerpo para tartera/sartén antiadherente

Corps pour plat rond/poêle · Körper für Pfanne/Pfanne
Body for round dish/frying pan · Corpo para tarteira/sertã

| Ref | € | Ø (cm) | h(cm) | e (mm) | L | U.Venta |
|-------|-------|--------|-------|--------|------|---------|
| 56820 | 31,70 | 20 | 4,0 | 0,8 | 1,00 | 1 |
| 56824 | 38,40 | 24 | 4,5 | 0,8 | 2,00 | 1 |
| 56828 | 51,10 | 28 | 5,0 | 0,8 | 3,00 | 1 |
| 56832 | 59,30 | 32 | 5,5 | 0,8 | 4,00 | 1 |



Asa

Poignée · Griff
Handle · Asa

| Ref | € | Color | U.Venta |
|-------|-------|---------------|---------|
| 56600 | 13,40 | Negro · Black | 1 |
| 56604 | 13,70 | Azul · Blue | 1 |
| 56602 | 13,70 | Rojo · Red | 1 |



Mango

Poignée · Griff
Handle · Cabo

| Ref | € | Color | U.Venta |
|-------|-------|---------------|---------|
| 56601 | 14,60 | Negro · Black | 1 |
| 56605 | 14,80 | Azul · Blue | 1 |
| 56603 | 14,80 | Rojo · Red | 1 |



Tapa

Couvercle · Deckel
Lid · Tampa

| Ref | € | Ø (cm) | U.Venta |
|-------|-------|--------|---------|
| 56914 | 16,90 | 14 | 1 |
| 56916 | 17,50 | 16 | 1 |
| 56918 | 18,30 | 18 | 1 |
| 56920 | 19,20 | 20 | 1 |
| 56924 | 20,50 | 24 | 1 |
| 56928 | 21,20 | 28 | 1 |
| 56932 | 22,10 | 32 | 1 |



Origin Collection



- Fabricadas en acero inoxidable 18/10 de la mejor calidad.
- Asas fabricadas en acero inoxidable con recubrimiento PVD (proceso de chapado iónico con titanio, metal de gran dureza).
- Tapa fabricada en vidrio templado con válvula de salida de vapor y aro protector de acero inoxidable con recubrimiento PVD.
- Máxima garantía en cuanto a resistencia, durabilidad e higiene.
- Marcaje de capacidades en el interior (litros).
- Fondo termodifusor sandwich (inox 18/10 - aluminio - inoxidable).
- Distribución rápida y uniforme del calor.
- Apta para todos los fuegos (incluido inducción y horno) . Apta para el lavavajillas.

- Fabriquées en acier inoxydable 18/10 de la meilleure qualité.
- Poignées en acier inoxydable avec revêtement PVD (procédé de placage ionique avec du titane, métal de haute dureté).Couvercle en verre trempé avec soupape d'évacuation de la vapeur et anneau de protection en acier inoxydable revêtu de PVD
- Garantie maximale en termes de résistance, de durabilité et d'hygiène.
- Marquage des contenances à l'intérieur (litres).
- Fond termodiffuseur sandwich (inox 18/10 - aluminium - inoxydable).
- Distribution rapide et uniforme de la chaleur.
- Apte pour tous les types de feux (y compris l'induction et le four). Aptes pour le lave-vaisselle.

- Maximum guarantee in resistance, durability and hygiene.
- Handles made of stainless steel with PVD coating (ionic plating process with titanium, high hardness metal).
- Lid made of tempered glass with steam outlet valve and protective ring made of PVD-coated stainless steel
- Maximum guarantee in terms of resistance, durability and hygiene.
- Capacity markings on the inside (litres).
- Heat-diffusing sandwiched base (18/10 stainless steel - aluminium - st. Steel).
- Quick and even heat distribution.
- Suitable for all types of cookers (including induction hobs and ovens). Dishwasher safe.



Recubrimiento PVD
PVD coating
Proceso de chapado iónico con titanio, metal de gran dureza
Ionic plating process with titanium, high hardness metal



Tapa fabricada en vidrio templado
Lid made of tempered glass
Aro protector de acero inoxidable con recubrimiento PVD
Protective ring made of PVD-coated stainless steel

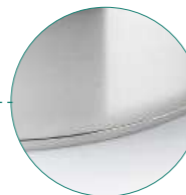

Distribución rápida y uniforme del calor
Quick and even heat distribution
Fondo termodifusor sandwich (inox 18/10 - aluminio - inoxidable)
Heat-diffusing sandwiched base (18/10 stainless steel - aluminium - st. Steel).



Cacerola con tapa

Faitout avec couvercle · Bratentopf mit Deckel
Casserole with lid · Caçarola com tampa

| Ref | € | Ø (cm) | h(cm) | e (mm) | L | U.Venta |
|-------|-------|--------|-------|--------|------|---------|
| 47020 | 50,20 | 20 | 10 | 0,8 | 3,00 | 1 |
| 47024 | 58,80 | 24 | 12 | 0,8 | 5,20 | 1 |
| 47028 | 68,70 | 28 | 14 | 0,8 | 8,30 | 1 |



Cacerola baja con tapa

Faitout bas avec couvercle · Bratentopf mit Deckel
asserole with lid · Caçarola baixa com tampa

| Ref | € | Ø (cm) | h(cm) | e (mm) | L | U.Venta |
|-------|-------|--------|-------|--------|------|---------|
| 47128 | 63,10 | 28 | 8 | 0,8 | 4,70 | 1 |



Cazo

Casserole · Stielkasserolle, flach
Saucepan · Caçarola direite

| Ref | € | Ø (cm) | h(cm) | e (mm) | L | U.Venta |
|-------|-------|--------|-------|--------|------|---------|
| 47214 | 26,00 | 14 | 7 | 0,8 | 1,00 | 1 |
| 47216 | 28,50 | 16 | 8 | 0,8 | 1,50 | 1 |
| 47218 | 31,20 | 18 | 9 | 0,8 | 2,10 | 1 |
| 47220 | 35,20 | 20 | 10 | 0,8 | 3,00 | 1 |

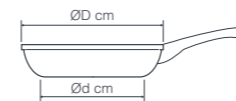

Tapa

Couvercle · Deckel
Lid · Tampa

| Ref | € | Ø (cm) | U.Venta |
|-------|-------|--------|---------|
| 47620 | 15,70 | 20 | 1 |
| 47624 | 17,00 | 24 | 1 |
| 47628 | 18,90 | 28 | 1 |

PFOA free

High release topcoat
Partially reinforced midcoat
Reinforced primer
(titanium-based particles)
Metal substrate

PPG Quantanium™
Titanium-reinforced non-stick coating

Antiadherente Quantanium® reforzado con partículas de titanio; libre de materiales tóxicos y pesados, ecológico y libre de PFOA
QuanTanium® non-stick reinforced with titanium particles; free from toxic and heavy materials, environmentally friendly and PFOA-free.



Sartén

Poêle · Pfanne
Frying pan · Sertã

| Ref | € | Ø (cm) | Ød (cm) | h(cm) | e (mm) | U.Venta |
|-------|-------|--------|---------|-------|--------|---------|
| 47318 | 25,00 | 18 | 12,5 | 4,00 | 0,6 | 1 |
| 47320 | 27,80 | 20 | 12,5 | 4,20 | 0,6 | 1 |
| 47322 | 30,00 | 22 | 16,8 | 4,40 | 0,6 | 1 |
| 47324 | 31,90 | 24 | 18,5 | 4,60 | 0,6 | 1 |
| 47328 | 35,70 | 28 | 21,2 | 4,80 | 0,6 | 1 |
| 47330 | 38,80 | 30 | 23,0 | 5,00 | 0,6 | 1 |



Sartén antiadherente

Poêle antiadherent · Pfanne, Antihaft
Frying-pan, non-stick · Sertã anti-aderente

| Ref | € | Ø (cm) | Ød (cm) | h(cm) | e (mm) | U.Venta |
|-------|-------|--------|---------|-------|--------|---------|
| 47418 | 29,60 | 18 | 12,5 | 4,00 | 0,6 | 1 |
| 47420 | 32,80 | 20 | 12,5 | 4,20 | 0,6 | 1 |
| 47422 | 35,20 | 22 | 16,8 | 4,40 | 0,6 | 1 |
| 47424 | 37,50 | 24 | 18,5 | 4,60 | 0,6 | 1 |
| 47428 | 42,50 | 28 | 21,2 | 4,80 | 0,6 | 1 |
| 47430 | 46,30 | 30 | 23,0 | 5,00 | 0,6 | 1 |



Foodie Collection

INOX 18/10 Sandwich Induction Vitro Electric Gas Oven Dishwasher

- Fabricada en acero inoxidable 18/10 de la mejor calidad.
- Asas y mangos ergonómicos de acero inoxidable fundido.
- Máxima garantía en cuanto a resistencia, durabilidad e higiene.
- Acabado interior y exterior lijado satinado.
- Marcaje de capacidades en el interior (litros).
- Fondo termodifusor sándwich (inox 18/10 - aluminio - inoxidable).
- Distribución rápida y uniforme del calor.
- Apta para todos los fuegos (incluido inducción y horno).

- Fabriqué en acier inoxydable 18/10 de la meilleure qualité.
- Poignées et purée de maîtrise en acier inoxydable en fusion.
- Garantie maximale en termes de résistance, de durabilité et d'hygiène.
- Satin de finition interne et extérieur.
- Marquage de capacité à l'intérieur (litres).
- Contexte de termodifusor sandwich (en acier inoxydable 18/10 - aluminium - en acier inoxydable).
- Distribution rapide et uniforme de la chaleur.
- Convient à tous les incendies (y compris l'induction et le four).

- Made of stainless steel 18/10 of the best quality.
- Asas and ergonomic mashed masters of molten stainless steel.
- Maximum guarantee in terms of resistance, durability and hygiene.
- Internal and exterior finish satin.
- Capacity marking inside (liters).
- Sandwich thermodifusor background (stainless 18/10 - Aluminum - stainless).
- Quick and uniform distribution of heat.
- Suitable for all fires (including induction and oven).



Cacerola con tapa

Faitout avec couvercle · Bratentopf mit Deckel
Casserole with lid · Caçarola com tampa

| Ref | € | Ø (cm) | h(cm) | e (mm) | L | U.Venta |
|-------|-------|--------|-------|--------|------|---------|
| 45016 | 46,90 | 16 | 7,5 | 0,8 | 1,50 | 1 |
| 45018 | 51,00 | 18 | 8,5 | 0,8 | 2,00 | 1 |
| 45020 | 55,70 | 20 | 9,5 | 0,8 | 3,00 | 1 |
| 45022 | 63,30 | 22 | 10,5 | 0,8 | 4,00 | 1 |
| 45024 | 69,80 | 24 | 11,5 | 0,8 | 5,00 | 1 |
| 45026 | 77,20 | 26 | 12,5 | 0,8 | 6,50 | 1 |
| 45028 | 83,40 | 28 | 12,5 | 0,8 | 7,50 | 1 |



Cazo

Casserole · Stielkasserolle, flach
Saucepan · Caçarola direite

| Ref | € | Ø (cm) | h(cm) | e (mm) | L | U.Venta |
|-------|-------|--------|-------|--------|------|---------|
| 45214 | 33,70 | 14 | 7,5 | 0,8 | 1,00 | 1 |
| 45216 | 36,30 | 16 | 7,5 | 0,8 | 1,50 | 1 |
| 45218 | 40,50 | 18 | 8,5 | 0,8 | 2,00 | 1 |
| 45220 | 45,90 | 20 | 9,5 | 0,8 | 3,00 | 1 |

Olla con tapa

Marmite avec couvercle · Fleischtopf mit Deckel
Stock pot with lid · Panela com tampa

| Ref | € | Ø (cm) | h(cm) | e (mm) | L | U.Venta |
|-------|-------|--------|-------|--------|-------|---------|
| 45116 | 51,70 | 16 | 13,0 | 0,8 | 2,50 | 1 |
| 45118 | 55,30 | 18 | 14,0 | 0,8 | 3,50 | 1 |
| 45120 | 62,50 | 20 | 15,5 | 0,8 | 4,80 | 1 |
| 45122 | 68,00 | 22 | 15,5 | 0,8 | 5,50 | 1 |
| 45124 | 75,70 | 24 | 16,0 | 0,8 | 7,00 | 1 |
| 45126 | 82,80 | 26 | 16,0 | 0,8 | 8,00 | 1 |
| 45128 | 94,00 | 28 | 17,0 | 0,8 | 10,00 | 1 |



Tartera con tapa

Plat rond avec couvercle · Pfanne mit Deckel
Round dish with lid · Tarteira com tampa

| Ref | € | Ø (cm) | h(cm) | e (mm) | L | U.Venta |
|-------|-------|--------|-------|--------|------|---------|
| 45624 | 64,20 | 24 | 6,5 | 0,8 | 2,80 | 1 |
| 45626 | 70,50 | 26 | 6,5 | 0,8 | 3,00 | 1 |
| 45628 | 76,20 | 28 | 6,5 | 0,8 | 4,00 | 1 |

Tapa

Couvercle · Deckel
Lid · Tampa



| Ref | € | Ø (cm) | U.Venta |
|-------|-------|--------|---------|
| 45916 | 12,60 | 16 | 1 |
| 45918 | 13,20 | 18 | 1 |
| 45920 | 14,30 | 20 | 1 |
| 45922 | 15,40 | 22 | 1 |
| 45924 | 17,00 | 24 | 1 |
| 45926 | 18,10 | 26 | 1 |
| 45928 | 20,00 | 28 | 1 |



Sartén

Poêle · Pfanne
Frying pan · Sertã

| Ref | € | Ø (cm) | Ød (cm) | h(cm) | e (mm) | U.Venta |
|-------|-------|--------|---------|-------|--------|---------|
| 45420 | 28,10 | 20 | 13,5 | 5,5 | 0,6 | 1 |
| 45422 | 29,90 | 22 | 14,5 | 5,5 | 0,6 | 1 |
| 45424 | 33,50 | 24 | 17,5 | 6,0 | 0,6 | 1 |
| 45426 | 35,60 | 26 | 19,0 | 6,0 | 0,6 | 1 |
| 45428 | 39,40 | 28 | 19,5 | 6,5 | 0,6 | 1 |
| 45430 | 40,60 | 30 | 22,0 | 6,5 | 0,6 | 1 |



High release topcoat
Partially reinforced midcoat
Reinforced primer
(titanium-based particles)
Metal substrate

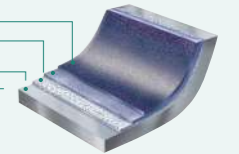

QuanTanium®
Titanium-reinforced non-stick coating

Antiadherente QuanTanium® reforzado con partículas de titanio; libre de materiales tóxicos y pesados, ecológico y libre de PFOA
QuanTanium® non-stick reinforced with titanium particles; free from toxic and heavy materials, environmentally friendly and PFOA-free.



Sartén antiadherente

Poêle antiadherent · Pfanne, Antihafit
Frying-pan, non-stick · Sertã anti-aderente

| Ref | € | Ø (cm) | Ød (cm) | h(cm) | e (mm) | U.Venta |
|-------|-------|--------|---------|-------|--------|---------|
| 45320 | 33,10 | 20 | 13,5 | 5,5 | 0,6 | 1 |
| 45322 | 34,30 | 22 | 14,5 | 5,5 | 0,6 | 1 |
| 45324 | 40,50 | 24 | 17,5 | 6,0 | 0,6 | 1 |
| 45326 | 41,50 | 26 | 19,0 | 6,0 | 0,6 | 1 |
| 45328 | 48,50 | 28 | 19,5 | 6,5 | 0,6 | 1 |
| 45330 | 49,60 | 30 | 22,0 | 6,5 | 0,6 | 1 |



Wok

Wok · Wok
Wok · Wok

| Ref | € | Ø (cm) | Ød (cm) | h(cm) | U.Venta |
|-------|-------|--------|---------|-------|---------|
| 45828 | 40,00 | 28 | 15,6 | 8,0 | 1 |



Wok antiadherente

Wok, Antiadherent · Wok, Antihalt
Wok, non-stick · Wok anti-aderente

| Ref | € | Ø (cm) | Ød (cm) | h(cm) | U.Venta |
|-------|-------|--------|---------|-------|---------|
| 45728 | 48,20 | 28 | 15,6 | 8,0 | 1 |



Crepera

Crepière · Crêpes-Pfanne
Crepiere · Crepeira

| Ref | € | Ø (cm) | Ød (cm) | h(cm) | U.Venta |
|-------|-------|--------|---------|-------|---------|
| 45829 | 39,50 | 28 | 24 | 1,8 | 1 |



Crepera antiadherente

Crepière, antiadherent · Crêpes-Pfanne, Antihafit
Crepiere, Non-stick · Crepeira anti-aderente

| Ref | € | Ø (cm) | Ød (cm) | h(cm) | U.Venta |
|-------|-------|--------|---------|-------|---------|
| 45729 | 42,30 | 28 | 24 | 1,8 | 1 |



Profesional Collection



- **Toda la pieza (cuerpo, asas y mangos) fabricada en acero inoxidable 18/10.**
- **Favorece una distribución rápida y homogénea del calor.**
- **Acabado pulido brillante exterior y lijado mate interior.**
- **Máxima garantía en cuanto a resistencia, durabilidad e higiene.**
- **Apta para todo tipo de cocinas (incluido inducción y horno).**
- **Fondo termodifusor sándwich (inox 18/10 - aluminio - inox).**

- La pièce entière (corps, poignées et mangues) en acier inoxydable 18/10.
- Il favorise une distribution rapide et homogène de la chaleur.
- Finition extérieure et polie et ponçage de Matt intérieur.
- Garantie maximale en termes de résistance, de durabilité et d'hygiène.
- Convient à tous les types de cuisines (y compris l'induction et le four).
- Contexte de termodifusor sandwich (en acier inoxydable 18/10 - aluminium - en acier inoxydable).

- The entire piece (body, handles and mangoes) made of stainless steel 18/10.
- It favors a quick and homogeneous distribution of heat.
- Exterior bright polished finish and inner matt sanding.
- Maximum guarantee in terms of resistance, durability and hygiene.
- Suitable for all types of kitchens (including induction and oven).
- Sandwich thermodifusor background (stainless 18/10 - aluminum - stainless).

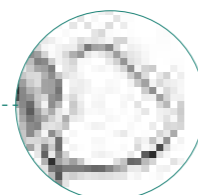

Asas y mangos ergonómicos fabricados en acero inoxidable 18/10
Handles and grips are made in 18/10 stainless steel

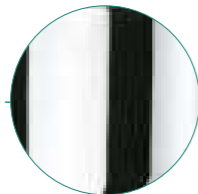

Acabado pulido brillante exterior y lijado mate interior
Exterior glossy, polished finish and sanded matte interior

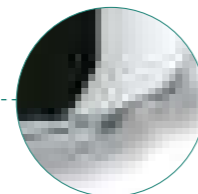

Fondo termodifusor sandwich (inox 18/10 - aluminio - inoxidable)
Heat-diffusing sandwiched base (18/10 stainless steel - aluminium - st. Steel).



Cacerola con tapa

Faitout a/couvercle · Bratentopf mit Deckel
Casserole with lid · Caçarola com tampa

| Ref | € | Ø (cm) | h(cm) | L | U.Venta |
|-------|--------|--------|-------|------|---------|
| 72016 | 52,70 | 16 | 8,0 | 1,50 | 1 |
| 72020 | 61,50 | 20 | 8,5 | 2,50 | 1 |
| 72024 | 72,00 | 24 | 9,5 | 3,50 | 1 |
| 72028 | 92,20 | 28 | 11,0 | 6,50 | 1 |
| 72032 | 125,10 | 32 | 12,5 | 9,00 | 1 |



Olla con tapa

Marmite a/couvercle · Fleischtopf mit Deckel
Stock pot with Lid · Panela com tampa

| Ref | € | Ø (cm) | h(cm) | L | U.Venta |
|-------|--------|--------|-------|-------|---------|
| 72116 | 56,90 | 16 | 13,0 | 2,50 | 1 |
| 72120 | 65,80 | 20 | 14,5 | 4,50 | 1 |
| 72124 | 79,10 | 24 | 15,0 | 6,50 | 1 |
| 72128 | 102,80 | 28 | 17,0 | 10,00 | 1 |



Olla alta con tapa

Marmite S. Haute a/couvercle · Hoher Fleischtopf mit Deckel
Deep Stock pot with Lid · Panela super alta com tampa

| Ref | € | Ø (cm) | h(cm) | L | U.Venta |
|-------|--------|--------|-------|-------|---------|
| 72125 | 86,40 | 24 | 20,0 | 9,00 | 1 |
| 72129 | 113,10 | 28 | 22,0 | 13,50 | 1 |



Cazo

Casserole · Stielkasserole, flach
Saucepan · Caçarola direita

| Ref | € | Ø (cm) | h(cm) | L | U.Venta |
|-------|-------|--------|-------|------|---------|
| 72214 | 28,20 | 14 | 7,5 | 1,00 | 1 |
| 72216 | 31,90 | 16 | 8,0 | 1,50 | 1 |
| 72218 | 34,30 | 18 | 8,5 | 2,00 | 1 |
| 72220 | 38,60 | 20 | 8,5 | 2,50 | 1 |



Pote cilíndrico

Pot-cilindrique · Milchtopf
Cylindrical pot · Caneca cilíndrica

| Ref | € | Ø (cm) | h(cm) | L | U.Venta |
|-------|-------|--------|-------|------|---------|
| 72714 | 33,20 | 14 | 12,5 | 1,50 | 1 |
| 72716 | 37,50 | 16 | 13,0 | 2,50 | 1 |



Tapa

Couvercle · Deckel
Lid · Tampa

| Ref | € | Ø (cm) | U.Venta |
|-------|-------|--------|---------|
| 72916 | 14,30 | 16 | 1 |
| 72920 | 17,40 | 20 | 1 |
| 72924 | 20,00 | 24 | 1 |
| 72928 | 25,90 | 28 | 1 |
| 72932 | 28,10 | 32 | 1 |



Belly Collection

INOX 18/10

Sandwich Induction Vitro Electric Gas Oven Dishwasher

- Toda la pieza (cuerpo y asas) fabricada en acero inoxidable 18/10.
- Máxima garantía en cuanto a resistencia, durabilidad e higiene.
- El diseño de cuerpos bombeados proporciona mayor capacidad.
- Marcaje de capacidades en el interior (litros).
- Fondo termodifusor sándwich (inox 18/10 - aluminio - inoxidable).
- Distribución rápida y uniforme del calor.
- Apta para todos los fuegos (incluido inducción y horno).
- Incluye tapa de cristal resistente a los golpes con válvula y borde de acero inoxidable 18/10.

- La pièce entière (corps et poignées) en acier inoxydable 18/10.
- Garantie maximale en termes de résistance, de durabilité et d'hygiène.
- La conception des corps de pompage offre une plus grande capacité.
- Marquage de capacité à l'intérieur (litres).
- Contexte de thermofusor sandwich (en acier inoxydable 18/10 - aluminium - en acier inoxydable).
- Distribution rapide et uniforme de la chaleur.
- Convient à tous les incendies (y compris l'induction et le four).
- Comprend un couvercle en cristal résistant aux coups avec une soupape et un bord en acier inoxydable 18/10.

- The entire piece (body and handles) made of stainless steel 18/10.
- Maximum guarantee in terms of resistance, durability and hygiene.
- The design of pumping bodies provides greater capacity.
- Capacity marking inside (liters).
- Sandwich thermofusor background (stainless 18/10 - Aluminum - stainless).
- Quick and uniform distribution of heat.
- Suitable for all fires (including induction and oven).
- Includes crystal lid resistant to blows with valve and stainless steel edge 18/10.



Tapa de cristal resistente a golpes con válvula y borde de acero inoxidable 18/10
Glass cover with pressure valve resistant to bumps and 18/10 stainless steel rim



Marcajes de capacidad en litros
Capacity markings inside in litres

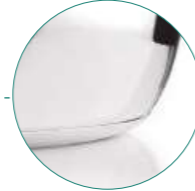

Fondo Curvo. Proporciona mayor capacidad
Curved bottom. Provides greater capacity



Cacerola con tapa
Faitout avec couvercle · Bratentopf mit Deckel
Casserole with lid · Caçarola com tampa

| Ref | € | Ø (cm) | h(cm) | e (mm) | L | U.Venta |
|-------|-------|--------|-------|--------|------|---------|
| 79016 | 38,80 | 16 | 8,5 | 0,6 | 1,20 | 1 |
| 79020 | 52,70 | 20 | 9,5 | 0,6 | 2,50 | 1 |
| 79024 | 71,80 | 24 | 11,5 | 0,7 | 4,40 | 1 |
| 79028 | 94,30 | 28 | 15,0 | 0,7 | 8,20 | 1 |



Cazo
Casserole · Stielkasserole, flach
Saucepan · Caçarola direita

| Ref | € | Ø (cm) | h(cm) | e (mm) | L | U.Venta |
|-------|-------|--------|-------|--------|------|---------|
| 79214 | 27,20 | 14 | 9,0 | 0,6 | 1,20 | 1 |
| 79216 | 31,70 | 16 | 9,5 | 0,6 | 1,60 | 1 |
| 79218 | 36,00 | 18 | 10,5 | 0,6 | 2,50 | 1 |
| 79220 | 41,50 | 20 | 11,5 | 0,6 | 3,50 | 1 |



Cacerola vapor
Panier vapeur · Dampfkoch-Aufsatz
Steam casserole · Caçarola a vapor

| Ref | € | Ø (cm) | h(cm) | e (mm) | L | U.Venta |
|-------|-------|--------|-------|--------|------|---------|
| 79420 | 33,80 | 20 | 9,5 | 0,6 | 3,00 | 1 |
| 79424 | 45,00 | 24 | 12,0 | 0,6 | 4,50 | 1 |



Wok
Wok · Wok
Wok · Wok

| Ref | € | Ø (cm) | h(cm) | e (mm) | L | U.Venta |
|-------|-------|--------|-------|--------|------|---------|
| 79830 | 60,90 | 30 | 10,0 | 0,7 | 4,50 | 4 |



Olla con tapa
Marmite avec couvercle · Fleischtopf mit Deckel
Stock pot with Lid · Panela com tampa

| Ref | € | Ø (cm) | h(cm) | e (mm) | L | U.Venta |
|-------|--------|--------|-------|--------|------|---------|
| 79116 | 43,40 | 16 | 10,0 | 0,6 | 1,60 | 1 |
| 79120 | 59,60 | 20 | 12,0 | 0,6 | 3,50 | 1 |
| 79124 | 76,40 | 24 | 14,0 | 0,6 | 5,50 | 1 |
| 79128 | 101,20 | 28 | 17,0 | 0,7 | 9,50 | 1 |



Tartera con tapa
Plat rond avec couvercle · Pfanne mit Deckel
Round dish with lid · Tarteira com tampa

| Ref | € | Ø (cm) | h(cm) | e (mm) | L | U.Venta |
|-------|-------|--------|-------|--------|------|---------|
| 79624 | 59,80 | 24 | 7,5 | 0,6 | 2,60 | 1 |
| 79628 | 75,90 | 28 | 7,5 | 0,7 | 3,00 | 1 |



Pote
Pot · Milchtopf
Pot · Caneca

| Ref | € | Ø (cm) | h(cm) | e (mm) | L | U.Venta |
|-------|-------|--------|-------|--------|------|---------|
| 79714 | 27,20 | 14 | 11,0 | 0,6 | 1,50 | 1 |



Tapa
Couvercle · Deckel
Lid · Tampa

| Ref | € | Ø (cm) | U.Venta |
|-------|-------|--------|---------|
| 79916 | 12,40 | 16 | 1 |
| 79920 | 16,60 | 20 | 1 |
| 79924 | 20,60 | 24 | 1 |
| 79928 | 25,90 | 28 | 1 |



Vitrocor Collection



- Toda la pieza (cuerpo, asas y mangos) fabricada en acero inoxidable 18/10.
- Favorece una distribución rápida y homogénea del calor.
- Destaca por su diseño clásico, funcionalidad y sencillez.
- Acabado pulido brillante exterior y lijado mate interior.
- Apta para todo tipo de cocinas (incluido inducción y horno).
- Fondo termodifusor sándwich (inox 18/10 - aluminio - inox).
- Apta para el lavavajillas.

- Toute la pièce (corps, poignées et manches) est fabriquée en acier inoxydable 18/10.
- Favorise une distribution rapide et homogène de la chaleur.
- Se distingue par son style classique, sa fonctionnalité et sa simplicité.
- Finition extérieure polie brillante et intérieur limage mat.
- Compatible avec tout type de cuisinières (y compris induction et four).
- Fond thermo-diffuseur sandwich (inox 18/10 - aluminium - inox).
- Apte pour le lave-vaisselle.

- The whole product (body, handles and grips) is made in 18/10 stainless steel.
- It favours quick and homogeneous heat distribution.
- Stands out for its classic design, functionality and simplicity.
- Exterior glossy, polished finish and sanded matte interior.
- Suitable for all types of cooking surfaces (including induction and the oven).
- Sandwich heat diffuser (18/10 stainless steel - aluminium - stainless steel).
- Dishwasher safe.



Cacerola con tapa

Faitout avec couvercle · Bratentopf mit Deckel
Casserole with lid · Caçarola com tampa

| Ref | € | Ø (cm) | h(cm) | L | U.Venta |
|-------|--------|--------|-------|-------|---------|
| 40016 | 40,30 | 16 | 8,0 | 1,50 | 1 |
| 40018 | 43,90 | 18 | 8,5 | 2,00 | 1 |
| 40020 | 48,50 | 20 | 8,5 | 2,50 | 1 |
| 40022 | 53,20 | 22 | 9,0 | 3,00 | 1 |
| 40024 | 56,90 | 24 | 9,5 | 3,50 | 1 |
| 40026 | 64,50 | 26 | 9,5 | 4,50 | 1 |
| 40028 | 82,60 | 28 | 11,0 | 6,50 | 1 |
| 40032 | 104,10 | 32 | 12,5 | 9,50 | 1 |
| 40036 | 141,60 | 36 | 14,0 | 14,20 | 1 |
| 40040 | 164,30 | 40 | 15,5 | 19,50 | 1 |



Cacerola vapor

Panier vapeur · Dampfkoch-Aufsatz
Steam casserole · Caçarola a vapor

| Ref | € | Ø (cm) | h(cm) | L | U.Venta |
|-------|-------|--------|-------|------|---------|
| 40420 | 36,00 | 20 | 8,5 | 2,50 | 1 |
| 40424 | 45,30 | 24 | 9,5 | 3,50 | 1 |
| 40428 | 49,70 | 28 | 11,0 | 6,50 | 1 |



Olla con tapa

Marmite avec couvercle · Fleischtopf mit Deckel
Stock pot with Lid · Panela com tampa

| Ref | € | Ø (cm) | h(cm) | L | U.Venta |
|-------|--------|--------|-------|-------|---------|
| 40116 | 45,30 | 16 | 13,0 | 2,50 | 1 |
| 40118 | 48,40 | 18 | 14,0 | 3,50 | 1 |
| 40120 | 52,80 | 20 | 14,5 | 4,50 | 1 |
| 40122 | 58,60 | 22 | 14,5 | 5,50 | 1 |
| 40124 | 65,80 | 24 | 15,0 | 6,50 | 1 |
| 40126 | 71,50 | 26 | 15,0 | 7,50 | 1 |
| 40128 | 90,40 | 28 | 17,0 | 10,00 | 1 |
| 40132 | 109,20 | 32 | 17,5 | 13,50 | 1 |
| 40136 | 154,80 | 36 | 21,5 | 22,00 | 1 |
| 40140 | 188,70 | 40 | 24,5 | 30,80 | 1 |



Cuecepastas sin tapa

Cuit-pâte sans couvercle · Nudelkoch-Einsatz ohne Deckel
Pasta cooker without lid · Coze-massas sem tampa

| Ref | € | Ø (cm) | h(cm) | L | U.Venta |
|-------|-------|--------|-------|------|---------|
| 40426 | 68,30 | 24 | 17,5 | 9,50 | 1 |



Olla alta con tapa

Marmite S. Haute a/couvercle · Hoher Fleischtopf mit Deckel
Deep Stock pot with Lid · Panela super alta com tampa

| Ref | € | Ø (cm) | h(cm) | L | U.Venta |
|-------|--------|--------|-------|-------|---------|
| 40121 | 57,70 | 20 | 17,5 | 5,50 | 1 |
| 40125 | 75,10 | 24 | 20,0 | 9,00 | 1 |
| 40129 | 100,70 | 28 | 22,0 | 13,50 | 1 |
| 40133 | 149,10 | 32 | 28,0 | 22,50 | 1 |



Pote cilíndrico

Pot-cilindrique · Milchtopf
Cylindrical pot · Caneca cilíndrica

| Ref | € | Ø (cm) | h(cm) | L | U.Venta |
|-------|-------|--------|-------|------|---------|
| 40712 | 29,80 | 12 | 12,0 | 1,00 | 1 |
| 40714 | 31,90 | 14 | 12,5 | 1,50 | 1 |
| 40716 | 35,00 | 16 | 13,0 | 2,50 | 1 |
| 40718 | 38,70 | 18 | 14,0 | 3,50 | 1 |



Sartén

Poêle · Pflanne
Frying pan · Sertã

| Ref | € | Ø (cm) | h(cm) | e (mm) | U.Venta |
|-------|-------|--------|-------|--------|---------|
| 40619 | 33,80 | 18 | 4,5 | 0,7 | 1 |
| 40621 | 36,00 | 20 | 4,5 | 0,7 | 1 |
| 40623 | 37,30 | 22 | 5,0 | 0,7 | 1 |
| 40625 | 39,90 | 24 | 5,2 | 0,7 | 1 |
| 40627 | 41,10 | 26 | 6,0 | 0,7 | 1 |
| 40629 | 44,10 | 28 | 6,5 | 0,7 | 1 |



Escurridera

Passoire sur pied · Abtropfschüssel
Colander with stand · Escorredor

| Ref | € | Ø (cm) | h(cm) | U.Venta |
|-------|-------|--------|-------|---------|
| 40324 | 50,20 | 24 | 11,0 | 1 |



Colador esférico

Passoire sur pied · Abtropfschüssel
Colander with stand · Escorredor

| Ref | € | Ø (cm) | h(cm) | U.Venta |
|-------|-------|--------|-------|---------|
| 40318 | 32,20 | 18 | 8,5 | 1 |



Cazo

Casserole · Stielkasserole, flach
Saucepan · Caçarola direite

| Ref | € | Ø (cm) | h(cm) | L | U.Venta |
|-------|-------|--------|-------|------|---------|
| 40212 | 25,30 | 12 | 7,0 | 0,80 | 1 |
| 40214 | 26,20 | 14 | 7,5 | 1,00 | 1 |
| 40216 | 29,70 | 16 | 8,0 | 1,50 | 1 |
| 40218 | 32,40 | 18 | 8,5 | 2,00 | 1 |
| 40220 | 37,60 | 20 | 8,5 | 2,50 | 1 |



Tartera con tapa

Plat rond avec couvercle · Pflanne mit Deckel
Round dish with lid · Tarteira com tampa

| Ref | € | Ø (cm) | h(cm) | L | U.Venta |
|-------|--------|--------|-------|-------|---------|
| 40620 | 48,40 | 20 | 6,5 | 2,00 | 1 |
| 40622 | 51,50 | 22 | 6,5 | 2,50 | 1 |
| 40624 | 56,70 | 24 | 7,0 | 3,00 | 1 |
| 40626 | 61,40 | 26 | 7,0 | 3,50 | 1 |
| 40628 | 76,60 | 28 | 8,0 | 4,50 | 1 |
| 40632 | 93,00 | 32 | 8,0 | 6,00 | 1 |
| 40636 | 123,30 | 36 | 8,5 | 7,50 | 1 |
| 40640 | 142,50 | 40 | 8,5 | 11,00 | 1 |



Tapa

Couvercle · Deckel
Lid · Tampa

| Ref | € | Ø (cm) | U.Venta |
|-------|-------|--------|---------|
| 40916 | 10,90 | 16 | 1 |
| 40918 | 11,10 | 18 | 1 |
| 40920 | 11,70 | 20 | 1 |
| 40922 | 12,40 | 22 | 1 |
| 40924 | 13,70 | 24 | 1 |
| 40926 | 14,60 | 26 | 1 |
| 40928 | 18,40 | 28 | 1 |
| 40932 | 23,00 | 32 | 1 |
| 40936 | 30,80 | 36 | 1 |
| 40940 | 35,00 | 40 | 1 |



Gourmet Collection

INOX
18/10



- Toda la pieza (cuerpo, asas y mangos) fabricada en acero inoxidable 18/10.
- Favorece una distribución rápida y homogénea del calor.
- Extremadamente robusta.
- Acabado pulido brillante exterior y lijado mate interior.
- Apta para todo tipo de cocinas (incluido inducción y horno).
- Triple fondo difusor que asegura un eficiente reparto del calor.

- Toute la pièce (corps, poignées et manches) est fabriquée en acier inoxydable 18/10.
- Favorise une distribution rapide et homogène de la chaleur.
- Extrêmement robustes.
- Finition extérieure polie brillante et intérieur limage mat.
- Compatible avec tout type de cuisinières (y compris induction et four).
- Triple fond diffuseur qui garantit une répartition efficace de la chaleur.

- The whole product (body, handles and grips) is made in 18/10 stainless steel.
- It favours quick and homogeneous heat distribution.
- Extremely robust.
- Exterior glossy, polished finish and sanded matte interior.
- Suitable for all types of cooking surfaces (including induction and the oven).
- Triple diffuser bottom assuring efficient distribution of heat.



Cacerola con tapa

Faitout avec couvercle · Bratentopf mit Deckel
Casserole with lid · Caçarola com tampa

| Ref | € | Ø (cm) | h(cm) | L | U.Venta |
|-------|--------|--------|-------|------|---------|
| 90016 | 44,80 | 16 | 8,0 | 1,50 | 1 |
| 90018 | 48,00 | 18 | 8,5 | 2,00 | 1 |
| 90020 | 52,70 | 20 | 8,5 | 2,50 | 1 |
| 90022 | 57,10 | 22 | 9,0 | 3,00 | 1 |
| 90024 | 61,70 | 24 | 9,5 | 3,50 | 1 |
| 90026 | 69,20 | 26 | 9,5 | 4,50 | 1 |
| 90028 | 85,00 | 28 | 11,0 | 6,50 | 1 |
| 90032 | 105,60 | 32 | 12,5 | 9,50 | 1 |



Olla con tapa

Marmite avec couvercle · Fleischtopf mit Deckel
Stock pot with Lid · Panela com tampa

| Ref | € | Ø (cm) | h(cm) | L | U.Venta |
|-------|--------|--------|-------|-------|---------|
| 90116 | 49,10 | 16 | 13,0 | 2,50 | 1 |
| 90118 | 53,10 | 18 | 14,0 | 3,50 | 1 |
| 90120 | 56,30 | 20 | 14,5 | 4,50 | 1 |
| 90122 | 62,70 | 22 | 14,5 | 5,50 | 1 |
| 90124 | 69,40 | 24 | 15,0 | 6,50 | 1 |
| 90126 | 74,90 | 26 | 15,0 | 7,50 | 1 |
| 90128 | 93,10 | 28 | 17,0 | 10,00 | 1 |
| 90132 | 120,60 | 32 | 17,5 | 13,50 | 1 |



Olla alta con tapa

Marmite S. Haute a/couvercle · Hoher Fleischtopf mit Deckel
Deep Stock pot with Lid · Panela super alta com tampa

| Ref | € | Ø (cm) | h(cm) | L | U.Venta |
|-------|--------|--------|-------|-------|---------|
| 90125 | 79,70 | 24 | 20,0 | 9,00 | 1 |
| 90129 | 103,50 | 28 | 22,0 | 13,50 | 1 |



Cacerola vapor

Panier vapeur · Dampfkoch-Aufsatz
Steam casserole · Caçarola a vapor

| Ref | € | Ø (cm) | h(cm) | L | U.Venta |
|-------|-------|--------|-------|------|---------|
| 90420 | 40,80 | 20 | 8,5 | 2,50 | 1 |
| 90424 | 50,10 | 24 | 9,5 | 3,50 | 1 |



Tartera con tapa

Plat rond a/couvercle · Pfanne mit Deckel
Round dish with lid · Tarteira com tampa

| Ref | € | Ø (cm) | h(cm) | L | U.Venta |
|-------|-------|--------|-------|------|---------|
| 90620 | 52,70 | 20 | 6,5 | 2,00 | 1 |
| 90622 | 56,40 | 22 | 6,5 | 2,50 | 1 |
| 90624 | 60,30 | 24 | 7,0 | 3,00 | 1 |
| 90626 | 65,30 | 26 | 7,0 | 3,50 | 1 |
| 90628 | 77,80 | 28 | 8,0 | 4,50 | 1 |
| 90632 | 96,80 | 32 | 8,0 | 6,00 | 1 |



Pote cilíndrico

Pot-cilindrique · Milchtopf
Cylindrical pot · Caneca cilíndrica

| Ref | € | Ø (cm) | h(cm) | L | U.Venta |
|-------|-------|--------|-------|------|---------|
| 90712 | 30,40 | 12 | 12,0 | 1,00 | 1 |
| 90714 | 32,20 | 14 | 12,5 | 1,50 | 1 |
| 90716 | 36,20 | 16 | 13,0 | 2,50 | 1 |
| 90718 | 39,10 | 18 | 14,0 | 3,50 | 1 |



Cazo

Casserole · Stielkasserole, flach
Saucepan · Caçarola direite

| Ref | € | Ø (cm) | h(cm) | L | U.Venta |
|-------|-------|--------|-------|------|---------|
| 90212 | 27,30 | 12 | 7,0 | 0,80 | 1 |
| 90214 | 28,90 | 14 | 7,5 | 1,00 | 1 |
| 90216 | 32,40 | 16 | 8,0 | 1,50 | 1 |
| 90218 | 35,00 | 18 | 8,5 | 2,00 | 1 |
| 90220 | 39,20 | 20 | 8,5 | 2,50 | 1 |



Colador esférico

Passoire à queue · Seiher, mit Stiel
Strainer · Coador esférico

| Ref | € | Ø (cm) | h(cm) | U.Venta |
|-------|-------|--------|-------|---------|
| 90318 | 32,20 | 18 | 8,5 | 1 |



Escurridera

Passoire à queue · Seiher, mit Stiel
Strainer · Coador esférico

| Ref | € | Ø (cm) | h(cm) | U.Venta |
|-------|-------|--------|-------|---------|
| 90324 | 48,70 | 24 | 11,0 | 1 |



Tapa

Couvercle · Deckel
Lid · Tampa

| Ref | € | Ø (cm) | U.Venta |
|-------|-------|--------|---------|
| 90916 | 12,00 | 16 | 1 |
| 90918 | 12,00 | 18 | 1 |
| 90920 | 12,10 | 20 | 1 |
| 90922 | 12,30 | 22 | 1 |
| 90924 | 13,60 | 24 | 1 |
| 90926 | 14,60 | 26 | 1 |
| 90928 | 19,10 | 28 | 1 |
| 90932 | 24,70 | 32 | 1 |



Pomo abatible
Folding knob



Estudio Collection



- **Cuerpo fabricado en acero inoxidable 18/10.**
- **Asas, mangos y pomo en baquelita termoaislante.**
- **Su pomo abatible consigue una reducción del espacio manteniendo una ergonomía perfecta.**
- **Acabado pulido brillante exterior y lijado mate interior.**
- **Triple fondo difusor que asegura un eficiente reparto del calor.**
- **Apta para todo tipo de cocinas (incluido inducción). Apta para el lavavajillas.**

- Corps en acier inoxydable 18/10.
- Poignées, mangues et bouton dans Thermoslante Baquelita.
- Son KNN pliant réalise une réduction de l'espace en maintenant une ergonomie parfaite.
- Finition extérieure et polie et ponçage de Matt intérieur.
- Contexte triple diffuseur qui garantit une distribution de chaleur efficace.
- Convient à tous les types de cuisines (y compris l'induction). Convient au lave-vaisselle.

- Body made of stainless steel 18/10.
- Handles, mangoes and knob in thermoslante baquelita.
- Its folding knn achieves a reduction in space maintaining a perfect ergonomics.
- Exterior bright polished finish and inner matt sanding.
- Triple diffuser background that ensures efficient heat distribution.
- Suitable for all types of kitchens (including induction). Suitable for dishwasher.



Cacerola con tapa

Faitout avec couvercle · Bratentopf mit Deckel
Casserole with lid · Caçarola com tampa

| Ref | € | Ø (cm) | h(cm) | L | U.Venta |
|-------|-------|--------|-------|------|---------|
| 85016 | 46,10 | 16 | 8,0 | 1,50 | 1 |
| 85018 | 49,70 | 18 | 8,5 | 2,00 | 1 |
| 85020 | 54,20 | 20 | 8,5 | 2,50 | 1 |
| 85022 | 58,20 | 22 | 9,0 | 3,00 | 1 |
| 85024 | 62,80 | 24 | 9,5 | 3,50 | 1 |
| 85026 | 68,50 | 26 | 9,5 | 4,50 | 1 |
| 85028 | 78,90 | 28 | 11,0 | 6,50 | 1 |



Olla con tapa

Marmite a/couvercle · Fleischtopf mit Deckel
Stock pot with Lid · Panela com tampa

| Ref | € | Ø (cm) | h(cm) | L | U.Venta |
|-------|-------|--------|-------|-------|---------|
| 85118 | 52,90 | 18 | 14,0 | 3,50 | 1 |
| 85120 | 58,10 | 20 | 14,5 | 4,50 | 1 |
| 85122 | 63,50 | 22 | 14,5 | 5,50 | 1 |
| 85124 | 69,60 | 24 | 15,0 | 6,50 | 1 |
| 85126 | 74,90 | 26 | 15,0 | 7,50 | 1 |
| 85128 | 88,40 | 28 | 17,0 | 10,00 | 1 |



Olla alta con tapa

Marmite S. Haute a/couvercle · Hoher Fleischtopf mit Deckel
Deep Stock pot with Lid · Panela super alta com tampa

| Ref | € | Ø (cm) | h(cm) | L | U.Venta |
|-------|-------|--------|-------|-------|---------|
| 85125 | 79,10 | 24 | 20,0 | 9,00 | 1 |
| 85129 | 97,60 | 28 | 22,0 | 13,50 | 1 |



Cacerola vapor

Panier vapeur · Dampfkoch-Aufsatz
Steam casserole · Caçarola a vapor

| Ref | € | Ø (cm) | h(cm) | L | U.Venta |
|-------|-------|--------|-------|------|---------|
| 85420 | 40,70 | 20 | 9,0 | 2,50 | 1 |
| 85424 | 49,80 | 24 | 10,5 | 3,50 | 1 |



Pote cilíndrico

Pot-cilindrique · Milchtopf
Cylindrical pot · Caneca cilíndrica

| Ref | € | Ø (cm) | h(cm) | L | U.Venta |
|-------|-------|--------|-------|------|---------|
| 85712 | 30,30 | 12 | 12,0 | 1,00 | 1 |
| 85714 | 32,50 | 14 | 12,5 | 1,50 | 1 |
| 85716 | 34,40 | 16 | 13,0 | 2,50 | 1 |
| 85718 | 38,20 | 18 | 14,0 | 3,50 | 1 |



Tapa

Couvercle · Deckel
Lid · Tampa

| Ref | € | Ø (cm) | U.Venta |
|-------|-------|--------|---------|
| 85916 | 9,40 | 16 | 1 |
| 85918 | 10,20 | 18 | 1 |
| 85920 | 11,20 | 20 | 1 |
| 85922 | 11,40 | 22 | 1 |
| 85924 | 12,60 | 24 | 1 |
| 85926 | 13,20 | 26 | 1 |
| 85928 | 17,00 | 28 | 1 |



Cazo

Casserole · Stielkasserole, flach
Saucepan · Caçarola direite

| Ref | € | Ø (cm) | h(cm) | L | U.Venta |
|-------|-------|--------|-------|------|---------|
| 85212 | 26,80 | 12 | 7,0 | 0,80 | 1 |
| 85214 | 28,10 | 14 | 7,5 | 1,00 | 1 |
| 85216 | 30,80 | 16 | 8,0 | 1,50 | 1 |
| 85218 | 34,20 | 18 | 8,5 | 2,00 | 1 |
| 85220 | 38,50 | 20 | 8,5 | 2,50 | 1 |



Sautex

Sauteuse · Sauteuse
Sauteuse · Frigideira

| Ref | € | Ø (cm) | h(cm) | L | U.Venta |
|-------|-------|--------|-------|------|---------|
| 85624 | 41,50 | 24 | 7,0 | 3,50 | 1 |



Sartén

Poêle · Pfanne
Frying pan · Sertás

| Ref | € | Ø (cm) | h(cm) | L | U.Venta |
|-------|-------|--------|-------|------|---------|
| 85625 | 39,20 | 24 | 7,0 | 3,50 | 1 |
| 85629 | 42,60 | 28 | 8,0 | 4,50 | 1 |



Lote 5 cazos

Ensemble 5 casseroles · Set 5 Tlg. Stielkasserollen
Set 5 saucepans · Lote de 5 caçarola

| Ref | € | Ø (cm) | U.Venta |
|-------|--------|--------|---------|
| 85003 | 158,30 | 12 | 1 |
| | | 14 | |
| | | 16 | |
| | | 18 | |
| | | 20 | |



Nova-Ladycor Collection



- **Cuerpo fabricado en acero inoxidable 18/10.**
- **Asas, mangos y pomo en baquelita termoaislante.**
- **Destaca por su diseño clásico, funcionalidad y sencillez.**
- **Acabado pulido brillante exterior y lijado mate interior.**
- **Triple fondo difusor que asegura un eficiente reparto del calor.**
- **Apta para todo tipo de cocinas (incluido inducción). Apta para el lavavajillas.**

- Corps en acier inoxydable 18/10.
- Poignées, mangues et bouton dans Thermoslante Baquelita.
- Il se distingue par sa conception classique, sa fonctionnalité et sa simplicité.
- Finition extérieure et polie et ponçage de Matt intérieur.
- Contexte triple diffuseur qui garantit une distribution de chaleur efficace.
- Convient à tous les types de cuisines (y compris l'induction). Convient au lave-vaisselle.

- Body made of stainless steel 18/10.
- Handles, mangoes and knob in thermoslante baquelita.
- It stands out for its classic design, functionality and simplicity.
- Exterior bright polished finish and inner matt sanding.
- Triple diffuser background that ensures efficient heat distribution.
- Suitable for all types of kitchens (including induction). Suitable for dishwasher.



Cacerola con tapa
Faitout avec couvercle · Bratentopf mit Deckel
Casserole with lid · Caçarola com tampa

| Ref | € | Ø (cm) | h(cm) | L | U.Venta |
|-------|--------|--------|-------|------|---------|
| 88016 | 45,60 | 16 | 8,0 | 1,50 | 1 |
| 88018 | 48,80 | 18 | 8,5 | 2,00 | 1 |
| 88020 | 53,10 | 20 | 8,5 | 2,50 | 1 |
| 88022 | 58,10 | 22 | 9,0 | 3,00 | 1 |
| 88024 | 62,00 | 24 | 9,5 | 3,50 | 1 |
| 88026 | 69,60 | 26 | 9,5 | 4,50 | 1 |
| 88028 | 84,60 | 28 | 11,0 | 9,50 | 1 |
| 88032 | 107,70 | 32 | 12,5 | 9,50 | 1 |



Olla con tapa
Marmite avec couvercle · Fleischtopf mit Deckel
Stock pot with Lid · Panela com tampa

| Ref | € | Ø (cm) | h(cm) | L | U.Venta |
|-------|--------|--------|-------|-------|---------|
| 88116 | 50,20 | 16 | 13,0 | 2,50 | 1 |
| 88118 | 53,00 | 18 | 14,0 | 3,50 | 1 |
| 88120 | 56,70 | 20 | 14,5 | 4,50 | 1 |
| 88122 | 62,00 | 22 | 14,5 | 5,50 | 1 |
| 88124 | 69,30 | 24 | 15,0 | 6,50 | 1 |
| 88126 | 77,00 | 26 | 15,0 | 7,50 | 1 |
| 88128 | 93,80 | 28 | 17,0 | 10,00 | 1 |
| 88132 | 113,20 | 32 | 17,5 | 13,50 | 1 |



Olla alta con tapa
Marmite S. Haute a/couvercle · Hoher Fleischtopf mit Deckel
Deep Stock pot with Lid · Panela super alta com tampa

| Ref | € | Ø (cm) | h(cm) | L | U.Venta |
|-------|--------|--------|-------|-------|---------|
| 88121 | 61,90 | 20 | 17,5 | 5,50 | 1 |
| 88125 | 78,80 | 24 | 20,0 | 9,00 | 1 |
| 88129 | 110,90 | 28 | 22,0 | 13,50 | 1 |



Cazo vapor
Panier vapeur · Dampfkoch-Aufsatz
Steam casserole · Caçarola a vapor

| Ref | € | Ø (cm) | h(cm) | L | U.Venta |
|-------|-------|--------|-------|------|---------|
| 88420 | 42,40 | 20 | 9,0 | 2,50 | 1 |
| 88424 | 52,10 | 24 | 10,5 | 3,50 | 1 |



Pote cilíndrico
Pot-cilindrique · Milchtopf
Cylindrical pot · Caneca cilíndrica

| Ref | € | Ø (cm) | h(cm) | L | U.Venta |
|-------|-------|--------|-------|------|---------|
| 88712 | 29,70 | 12 | 12,0 | 1,00 | 1 |
| 88714 | 32,20 | 14 | 12,5 | 1,50 | 1 |
| 88716 | 35,10 | 16 | 13,0 | 2,50 | 1 |
| 88718 | 38,70 | 18 | 14,0 | 3,50 | 1 |



Colador esférico
Passoire à queue · Seiher, mit Stiel
Strainer · Coador esférico

| Ref | € | Ø (cm) | h(cm) | U.Venta |
|-------|-------|--------|-------|---------|
| 88318 | 34,70 | 18 | 8,5 | 1 |



Cazo
Casserole · Stielkasserole, flach
Saucepan · Caçarola direite

| Ref | € | Ø (cm) | h(cm) | L | U.Venta |
|-------|-------|--------|-------|------|---------|
| 88212 | 27,10 | 12 | 7,0 | 0,80 | 1 |
| 88214 | 28,10 | 14 | 7,5 | 1,00 | 1 |
| 88216 | 30,80 | 16 | 8,0 | 1,50 | 1 |
| 88218 | 33,80 | 18 | 8,5 | 2,00 | 1 |
| 88220 | 38,70 | 20 | 8,5 | 2,50 | 1 |



Tartera con tapa
Plat rond avec couvercle · Pfanne mit Deckel
Round dish with lid · Tarteira com tampa

| Ref | € | Ø (cm) | h(cm) | L | U.Venta |
|-------|-------|--------|-------|------|---------|
| 88620 | 52,70 | 20 | 6,5 | 2,00 | 1 |
| 88622 | 56,70 | 22 | 6,5 | 2,50 | 1 |
| 88624 | 60,80 | 24 | 7,0 | 3,00 | 1 |
| 88626 | 65,40 | 26 | 7,0 | 3,50 | 1 |
| 88628 | 74,50 | 28 | 8,0 | 4,50 | 1 |
| 88632 | 95,10 | 32 | 8,0 | 6,00 | 1 |



Tapa
Couvercle · Deckel
Lid · Tampa

| Ref | € | Ø (cm) | U.Venta |
|-------|-------|--------|---------|
| 88916 | 10,70 | 16 | 1 |
| 88918 | 10,90 | 18 | 1 |
| 88920 | 11,50 | 20 | 1 |
| 88922 | 11,80 | 22 | 1 |
| 88924 | 12,60 | 24 | 1 |
| 88926 | 14,20 | 26 | 1 |
| 88928 | 17,60 | 28 | 1 |
| 88932 | 24,00 | 32 | 1 |



Escurridera
Passoire sur pied · Abtropfschüssel
Colander with stand · Escorredor

| Ref | € | Ø (cm) | h(cm) | U.Venta |
|-------|-------|--------|-------|---------|
| 88324 | 49,10 | 24 | 11,0 | 1 |

Caliza Collection

new



- **Cuerpo fabricado en acero inoxidable 18/10.**
- **Asas, mangos y pomo en baquelita termoaislante.**
- **Acabado pulido brillante exterior y lijado mate interior.**
- **Triple fondo difusor que asegura un eficiente reparto del calor.**
- **Apta para todo tipo de cocinas (incluida inducción).**
- **Apta para el lavavajillas.**

- Corps fabriqué en acier inoxydable 18/10.
- Poignées, manches et pommeau en bakélite thermo-isolante.
- Finition polie brillante extérieur et limage mat intérieur.
- Triple fond diffuseur qui garantit une répartition efficace de la chaleur.
- Compatible avec tout type de cuisinières (y compris induction).
- Apte pour le lave-vaisselle.

- Body made in 18/10 stainless steel.
- Handles, grips and knob in heat resistant bakelite.
- Exterior glossy, polished finish and sanded matte interior.
- Triple diffuser bottom assuring efficient distribution of heat.
- Suitable for all types of cooking surfaces (including induction).
- Dishwasher safe.



Cacerola con tapa
Faitout avec couvercle · Bratentopf mit Deckel
Casserole with lid · Caçarola com tampa

| Ref | € | Ø (cm) | h(cm) | L | U.Venta |
|-------|-------|--------|-------|------|---------|
| 80016 | 45,60 | 16 | 8,0 | 1,50 | 1 |
| 80018 | 48,70 | 18 | 8,5 | 2,00 | 1 |
| 80020 | 53,10 | 20 | 8,5 | 2,50 | 1 |
| 80022 | 58,10 | 22 | 9,0 | 3,00 | 1 |
| 80024 | 62,00 | 24 | 9,5 | 3,50 | 1 |
| 80026 | 69,50 | 26 | 9,5 | 4,50 | 1 |
| 80028 | 84,60 | 28 | 11,0 | 9,50 | 1 |



Olla con tapa
Marmite avec couvercle · Fleischtopf mit Deckel
Stock pot with Lid · Panela com tampa

| Ref | € | Ø (cm) | h(cm) | L | U.Venta |
|-------|-------|--------|-------|-------|---------|
| 80116 | 50,20 | 16 | 13,0 | 2,50 | 1 |
| 80118 | 52,90 | 18 | 14,0 | 3,50 | 1 |
| 80120 | 56,60 | 20 | 14,5 | 4,50 | 1 |
| 80122 | 62,00 | 22 | 14,5 | 5,50 | 1 |
| 80124 | 69,30 | 24 | 15,0 | 6,50 | 1 |
| 80126 | 77,00 | 26 | 15,0 | 7,50 | 1 |
| 80128 | 93,70 | 28 | 17,0 | 10,00 | 1 |



Cazo
Casserole · Stielkasserole, flach
Saucepan · Caçarola direita

| Ref | € | Ø (cm) | h(cm) | L | U.Venta |
|-------|-------|--------|-------|------|---------|
| 80212 | 27,10 | 12 | 7,0 | 0,80 | 1 |
| 80214 | 28,00 | 14 | 7,5 | 1,00 | 1 |
| 80216 | 30,80 | 16 | 8,0 | 1,50 | 1 |
| 80218 | 33,80 | 18 | 8,5 | 2,00 | 1 |



Tartera con tapa
Plat rond avec couvercle · Pflanne mit Deckel
Round dish with lid · Tarteira com tampa

| Ref | € | Ø (cm) | h(cm) | L | U.Venta |
|-------|-------|--------|-------|------|---------|
| 80624 | 60,70 | 24 | 7,0 | 3,00 | 1 |
| 80626 | 65,40 | 26 | 7,0 | 3,50 | 1 |
| 80628 | 74,40 | 28 | 8,0 | 4,50 | 1 |



Pote cilíndrico
Pot-cylindrique · Milchtopf
Cylindrical pot · Caneca cilíndrica

| Ref | € | Ø (cm) | h(cm) | L | U.Venta |
|-------|-------|--------|-------|------|---------|
| 80714 | 32,10 | 14 | 12,5 | 1,50 | 1 |
| 80716 | 35,10 | 16 | 13,0 | 2,50 | 1 |
| 80718 | 38,70 | 18 | 14,0 | 3,50 | 1 |



Tapa
Couvercle · Deckel
Lid · Tampa

| Ref | € | Ø (cm) | U.Venta |
|-------|-------|--------|---------|
| 80916 | 10,70 | 16 | 1 |
| 80918 | 10,90 | 18 | 1 |
| 80920 | 11,50 | 20 | 1 |
| 80922 | 11,80 | 22 | 1 |
| 80924 | 12,60 | 24 | 1 |
| 80926 | 14,20 | 26 | 1 |
| 80928 | 17,50 | 28 | 1 |

Garinox Collection



- **Cuerpo fabricado en acero inoxidable 18/10.**
- **Asas, mangos y pomo en baquelita termoaislante.**
- **Acabado pulido brillante.**
- **Fondo Termomodifusor (inox 18/10 - aluminio - inox).**
- **Apta para todo tipo de cocinas (incluido inducción).**
- **Apta para el lavavajillas.**

- Corps en acier inoxydable 18/10.
- Poignées, mangues et bouton dans Thermoslante Baquelita.
- Finition polie brillante.
- Fond thermomodifusor (acier inoxydable 18/10 - aluminium - inoxydable).
- Convient à tous les types de cuisines (y compris l'induction).
- Convient au lave-vaisselle.

garinox®

- Body made of stainless steel 18/10.
- Handles, mangoes and knob in thermoslante baquelita.
- Bright polished finish.
- Thermomodifusor background (stainless 18/10 - aluminum - stainless).
- Suitable for all types of kitchens (including induction).
- Suitable for dishwasher.



Cacerola con tapa
Faitout a/couvercle · Bratentopf mit Deckel
Casserole with lid · Caçarola com tampa

| Ref | € | Ø (cm) | h(cm) | e (mm) | L | U.Venta |
|-------|-------|--------|-------|--------|------|---------|
| 14318 | 29,40 | 18 | 9,0 | 0,5 | 2,00 | 1 |
| 14320 | 33,90 | 20 | 10,0 | 0,5 | 3,00 | 1 |
| 14322 | 40,10 | 22 | 11,0 | 0,5 | 4,00 | 1 |
| 14324 | 46,20 | 24 | 12,0 | 0,5 | 5,00 | 1 |



Olla con tapa
Marmite avec couvercle · Fleischtopf mit Deckel
Stock pot with Lid · Panela com tampa

| Ref | € | Ø (cm) | h(cm) | e (mm) | L | U.Venta |
|-------|-------|--------|-------|--------|------|---------|
| 14420 | 36,40 | 20 | 12,0 | 0,5 | 3,80 | 1 |
| 14422 | 42,60 | 22 | 13,0 | 0,5 | 5,00 | 1 |
| 14424 | 51,10 | 24 | 15,0 | 0,5 | 7,00 | 1 |

Cazo 18/10
Casserole · Stielkasserole, flach
Saucepan · Caçarola direita

| Ref | € | Ø (cm) | h(cm) | e (mm) | L | U.Venta |
|-------|-------|--------|-------|--------|------|---------|
| 14212 | 10,50 | 12 | 5,5 | 0,5 | 0,60 | 1 |
| 14214 | 13,00 | 14 | 6,5 | 0,5 | 1,50 | 1 |
| 14216 | 16,20 | 16 | 7,5 | 0,5 | 1,50 | 1 |
| 14218 | 19,60 | 18 | 9,0 | 0,5 | 2,00 | 1 |
| 14220 | 23,10 | 20 | 10,0 | 0,5 | 3,00 | 1 |



Ideal para calentar leche, chocolate y salsas

Ideal for heating milk, making chocolate and sauces

Mango de baquelita termoaislante
Heat-insulating bakelite handle



INOX

Cazo Inox
Casserole · Stielkasserole
Saucepan · Caçarole

| Ref | € | Ø (cm) | h(cm) | L | U.Venta |
|-------|-------|--------|-------|------|---------|
| 31212 | 9,30 | 12 | 6,5 | 0,50 | 1 |
| 31214 | 10,70 | 14 | 7,0 | 1,00 | 1 |
| 31216 | 11,90 | 16 | 7,5 | 1,50 | 1 |
| 31218 | 13,60 | 18 | 8,0 | 2,00 | 1 |
| 31220 | 14,60 | 20 | 8,0 | 2,50 | 1 |

Mango de baquelita termoaislante
Heat-insulating bakelite handle

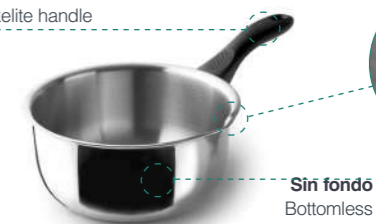

INOX

Cazo Vertedor
Casserole · Stielkasserole
Saucepan · Caçarole de verter

| Ref | € | Ø (cm) | h(cm) | L | U.Venta |
|-------|-------|--------|-------|------|---------|
| 31312 | 9,70 | 12 | 6,5 | 0,50 | 1 |
| 31314 | 11,00 | 14 | 7,0 | 1,00 | 1 |
| 31316 | 12,20 | 16 | 7,5 | 1,50 | 1 |
| 31318 | 13,90 | 18 | 8,0 | 2,00 | 1 |
| 31320 | 14,50 | 20 | 8,0 | 2,50 | 1 |

Pico vertedor
Pouring spout.

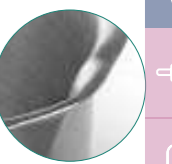

Sin fondo
Bottomless



Basic Collection



- **Toda la pieza (cuerpo, asas y mangos) fabricada en acero inoxidable.**
- **La tapa, con cierre de precisión, preserva los aromas y retiene el calor.**
- **Ideal para cocinar de forma saludable y ahorrar energía.**
- **Acabado interior lijado satinado y exterior pulido brillante.**
- **Apta para todo tipo de cocinas (incluido inducción y horno).**
- **Apta para el lavavajillas.**

- La pièce entière (corps, poignées et mangues) en acier inoxydable.
- Le couvercle, avec fermeture de précision, conserve les arômes et conserve la chaleur.
- Idéal pour cuisiner de manière saine et économiser de l'énergie.
- Finition intérieure satinée et extérieure et polie brillante.
- Convient à tous les types de cuisines (y compris l'induction et le four).
- Convient au lave-vaisselle.

- The entire piece (body, handles and mangoes) made of stainless steel.
- The lid, with precision closure, preserves the aromas and retains heat.
- Ideal to cook in a healthy way and save energy.
- Satinated and exterior interior finish and bright polished.
- Suitable for all types of kitchens (including induction and oven).
- Suitable for dishwasher.



Cacerola con tapa
Faitout a/couvercle · Bratentopf mit Deckel
Casserole with lid · Caçarola com tampa

| Ref | € | Ø (cm) | h(cm) | e (mm) | L | U.Venta |
|-------|-------|--------|-------|--------|------|---------|
| 32016 | 33,30 | 16 | 8,0 | 0,7 | 1,50 | 1 |
| 32020 | 40,50 | 20 | 8,5 | 0,7 | 2,50 | 1 |
| 32024 | 50,20 | 24 | 9,5 | 0,7 | 3,50 | 1 |
| 32028 | 64,90 | 28 | 11,0 | 0,8 | 6,50 | 1 |



Olla alta con tapa
Marmite S. Haute a/couvercle · Hoher Fleischtopf mit Deckel
Deep Stock pot with Lid · Panela super alta com tampa

| Ref | € | Ø (cm) | h(cm) | e (mm) | L | U.Venta |
|-------|-------|--------|-------|--------|-------|---------|
| 32125 | 69,70 | 24 | 20,0 | 0,7 | 9,00 | 1 |
| 32129 | 87,90 | 28 | 22,5 | 0,7 | 13,50 | 1 |



Olla con tapa
Marmite avec couvercle · Fleischtopf mit Deckel
Stock pot with Lid · Panela com tampa

| Ref | € | Ø (cm) | h(cm) | e (mm) | L | U.Venta |
|-------|-------|--------|-------|--------|-------|---------|
| 32116 | 40,50 | 16 | 13,0 | 0,7 | 2,50 | 1 |
| 32120 | 44,90 | 20 | 13,5 | 0,7 | 4,50 | 1 |
| 32124 | 56,80 | 24 | 15,0 | 0,7 | 6,50 | 1 |
| 32128 | 73,90 | 28 | 17,0 | 0,7 | 10,00 | 1 |



Cazo
Pot-cilindrique · Milchtopf
Cylindrical pot · Caneca cilíndrica

| Ref | € | Ø (cm) | h(cm) | e (mm) | L | U.Venta |
|-------|-------|--------|-------|--------|------|---------|
| 32214 | 19,70 | 14 | 7,5 | 0,7 | 1,00 | 1 |
| 32216 | 22,80 | 16 | 8,0 | 0,7 | 1,50 | 1 |
| 32218 | 25,30 | 18 | 8,5 | 0,7 | 2,00 | 1 |
| 32220 | 28,80 | 20 | 8,5 | 0,7 | 2,50 | 1 |



Cacerola vapor
Panier vapeur · Dampfkoch-Aufsatz
Steam casserole · Caçarola a vapor

| Ref | € | Ø (cm) | h(cm) | e (mm) | L | U.Venta |
|-------|-------|--------|-------|--------|------|---------|
| 32420 | 25,80 | 20 | 8,5 | 0,7 | 2,50 | 1 |
| 32424 | 30,20 | 24 | 9,5 | 0,7 | 3,50 | 1 |



Pote cilíndrico
Pot-cilindrique · Milchtopf
Cylindrical pot · Caneca cilíndrica

| Ref | € | Ø (cm) | h(cm) | e (mm) | L | U.Venta |
|-------|-------|--------|-------|--------|------|---------|
| 32714 | 25,30 | 14 | 12,5 | 0,7 | 1,50 | 1 |
| 32716 | 29,60 | 16 | 13,0 | 0,7 | 2,50 | 1 |



Tapa
Couvercle · Deckel
Lid · Tampa

| Ref | € | Ø (cm) | e (mm) | U.Venta |
|-------|-------|--------|--------|---------|
| 32916 | 9,60 | 16 | 0,7 | 1 |
| 32920 | 11,50 | 20 | 0,7 | 1 |
| 32924 | 13,50 | 24 | 0,7 | 1 |
| 32928 | 16,90 | 28 | 0,7 | 1 |



Cuscusera
Couscoussier · Couscous-Maschine
Couscouss maker · Máquina de fazer cuscuz

| Ref | € | Ø (cm) | h (cm) | U.Venta |
|-------|-------|--------|--------|---------|
| 32520 | 20,40 | 20 | 8,5 | 1 |
| 32524 | 24,80 | 24 | 9,5 | 1 |



Tartera con tapa
Plat rond avec couvercle · Pfanne mit Deckel
Round dish with lid · Tarteira com tampa

| Ref | € | Ø (cm) | h(cm) | e (mm) | L | U.Venta |
|-------|-------|--------|-------|--------|------|---------|
| 32624 | 42,10 | 24 | 7,0 | 0,7 | 3,00 | 1 |
| 32628 | 59,10 | 28 | 8,0 | 0,7 | 4,50 | 1 |



Lote 4 cazos
Ensemble 4 casseroles · Set 4 Tlg. Stielkasserollen
Set 4 saucepans · Lote de 4 caçarola

| Ref | € | Ø (cm) | U.Venta |
|-------|-------|--------|---------|
| 32003 | 95,60 | 14 | 1 |
| | | 16 | |
| | | 18 | |
| | | 20 | |

Colador esférico
Passoire à queue · Seiher, mit Stiel
Strainer · Coador esférico

| Ref | € | Ø (cm) | h(cm) | e (mm) | U.Venta |
|-------|-------|--------|-------|--------|---------|
| 32318 | 38,70 | 18 | 8,5 | 0,7 | 1 |



Escurridera
Passoire sur pied · Abtropfschüssel
Colander with stand · Escorredor

| Ref | € | Ø (cm) | h(cm) | e (mm) | U.Venta |
|-------|-------|--------|-------|--------|---------|
| 32324 | 53,60 | 24 | 11,0 | 0,7 | 1 |



- **Fabricada en acero inoxidable 18/10 de gran calidad.**
- **Acabado interior satinado y exterior brillo.**
- **Garantía máxima en cuanto a resistencia, durabilidad e higiene.**
- **Versátil: diseñado para cocinar cuscús y alimentos al vapor. También puede utilizarse como escurridera.**
- **Fondo perforado con agujeros de Ø2,5 mm.**
- **Excelente absorción y reparto del calor, proporciona unos resultados perfectos conservando las propiedades nutritivas y sabor atural de los alimentos**
- **Se adapta perfectamente a ollas y cacerolas del mismo diámetro.**
- **Asas de acero inoxidable de diseño ergonómico con acabado pulido brillante.**

- Made of high quality 18/10 stainless steel.
- Satin interior and glossy exterior finish.
- Maximum guarantee in terms of resistance, durability and hygiene.
- Versatile: designed for cooking couscous and steamed food.
- Can also be used as a colander.
- Perforated bottom with Ø2.5 mm holes.
- Excellent heat absorption and heat distribution, providing perfect results while preserving the nutritional properties and natural flavour of the food.
- Ergonomically designed stainless steel handles with bright polished finish.



Forte Collection



- Fabricada en aluminio fundido y construida en una sola pieza.
- Máxima robustez y gran resistencia a la deformación.
- Ideal para guisos, cocidos, sopas y salsas.
- Revestimiento antiadherente interior y exterior, libre de PFOA.
- Apta para todo tipo de cocinas (incluido inducción).
- Incluye una tapa de vidrio templado con válvula resistente a los golpes.

- Fabriqué en aluminium fondu et construit en une seule pièce.
- Robustesse maximale et grande résistance à la déformation.
- Idéal pour les ragoûts, cuits, les soupes et les sauces.
- Revêtement anti-anti-intérieur et extérieur, exempt de PFOA.
- Convient à tous les types de cuisines (y compris l'induction).
- Comprend un couvercle en verre trempé avec une valve résistante à un coup.

- Manufactured in molten and built aluminum in one piece.
- Maximum robustness and great resistance to deformation.
- Ideal for stews, cooked, soups and sauces.
- Interior and exterior antiating coating, free of PFOA.
- Suitable for all types of kitchens (including induction).
- Includes a tempered glass lid with blow-resistant valve.



Cacerola con tapa

Faitout avec couvercle verre · Bratentopf mit Glasdeckel
Round casserole with glass lid · Caçarola com tampa de vidro

| Ref | € | Ø (cm) | h(cm) | L | U.Venta |
|-------|-------|--------|-------|------|---------|
| 25816 | 32,50 | 16 | 8,5 | 1,20 | 1 |
| 25820 | 35,10 | 20 | 8,5 | 2,20 | 1 |
| 25824 | 43,90 | 24 | 10,5 | 4,40 | 1 |
| 25828 | 53,70 | 28 | 12,5 | 6,40 | 1 |
| 25831 | 63,80 | 30 | 13,5 | 8,40 | 1 |



Cacerola baja con tapa

Faitout bas avec couvercle verre · Bratentopf mit Glasdeckel
Round low casserole with glass lid · Caçarola baixa com tampa de vidro

| Ref | € | Ø (cm) | h(cm) | L | U.Venta |
|-------|-------|--------|-------|------|---------|
| 25823 | 44,10 | 24 | 7,5 | 2,30 | 1 |
| 25827 | 54,00 | 28 | 7,5 | 3,70 | 1 |
| 25832 | 70,00 | 32 | 7,5 | 5,70 | 1 |
| 25835 | 81,00 | 36 | 8,5 | 7,40 | 1 |



Cacerola cuadrada con tapa

Faitout carré avec couvercle verre · Bratentopf mit Glasdeckel
Square casserole with glass lid · Caçarola quadrada com tampa de vidro

| Ref | € | cm | h(cm) | L | U.Venta |
|-------|-------|-------|-------|-----|---------|
| 25829 | 63,50 | 28x28 | 12,0 | 7,5 | 1 |

Stilo Collection

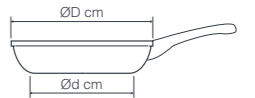

- Fabricada en aluminio fundido de gran calidad y espesor.
- Recubrimiento antiadherente acabado en partículas de piedra, libre de materiales tóxicos y pesados. Ecológico y libre de PFOA.
- La base de aluminio permite una distribución homogénea del calor, permitiendo que los alimentos se cocinen rápidamente y de manera uniforme, sin apenas utilizar aceite.
- Máxima resistencia al desgaste.
- Fácil limpieza interior y exterior gracias a su protección antiadherente.
- Compatibilidad: todo tipo de cocinas, incluida la inducción.
- Pomo y asas ergonómicas con acabado Soft Touch.
- Tapa de cristal con borde de silicona.

- Fabriqué en aluminium fondu de haute qualité et épaisseur.
- Finition de revêtement anticaracte dans les particules de pierre, exemptes de matériaux toxiques et lourds. Écologique et sans PFOA.
- La base en aluminium permet une distribution homogène de la chaleur, permettant aux aliments de cuire rapidement et uniformément, avec presque aucune huile.
- Résistance à l'usure maximale.
- Nettoyage intérieur et extérieur facile grâce à sa protection non-assise.
- Compatibilité: tous les types de cuisines, y compris l'induction.
- Poignées pomotives et ergonomiques avec finition tactile douce.
- Couvercle en cristal avec bord de silicone.

- Manufactured in molten aluminum of high quality and thickness.
- Antiating coating Finish in stone particles, free of toxic and heavy materials. Ecological and free of PFOA.
- The aluminum base allows a homogeneous distribution of heat, allowing food to cook quickly and uniformly, with hardly any oil.
- Maximum wear resistance.
- Easy interior and exterior cleaning thanks to its non-stick protection.
- Compatibility: all types of kitchens, including induction.
- Pomotive and ergonomic handles with soft touch finish.
- Crystal lid with silicone edge.



Cacerola con tapa

Faitout avec couvercle verre · Bratentopf mit Glasdeckel
Casserole with glass lid · Caçarola com tampa de vidro

| Ref | € | Ø (cm) | h(cm) | L | U.Venta |
|-------|-------|--------|-------|------|---------|
| 27320 | 53,50 | 20 | 10,5 | 2,50 | 1 |
| 27324 | 62,00 | 24 | 12,0 | 4,00 | 1 |
| 27328 | 73,20 | 28 | 12,5 | 6,00 | 1 |



Tartera con tapa

Faitout bas avec couvercle verre · Bratentopf mit Glasdeckel
Low casserole with glass lid · Caçarola baixa com tampa de vidro

| Ref | € | Ø (cm) | h(cm) | L | U.Venta |
|-------|-------|--------|-------|------|---------|
| 27327 | 69,30 | 28 | 8,5 | 4,00 | 1 |



Cazo

Casserole · Stielkasserole, flach
Saucepan · Caçarola direita

| Ref | € | Ø (cm) | h(cm) | L | U.Venta |
|-------|-------|--------|-------|------|---------|
| 27416 | 34,10 | 16 | 7,5 | 1,20 | 1 |
| 27418 | 36,40 | 18 | 8,8 | 1,80 | 1 |



Sartén

Poêle · Pfanne
Frying pan · Sertã

| Ref | € | Ø (cm) | Ød (cm) | h(cm) | U.Venta |
|-------|-------|--------|---------|-------|---------|
| 27620 | 35,50 | 20 | 16,5 | 4,5 | 6 |
| 27624 | 40,60 | 24 | 20,0 | 5,2 | 6 |
| 27626 | 44,80 | 26 | 21,5 | 5,5 | 6 |
| 27628 | 48,40 | 28 | 24,0 | 6,0 | 6 |

Válvula salida de vapor
Steam outlet valve

Aro protector de silicona
Silicone protective ring



Tapa

Couvercle verre · Glasdeckel
Glass lid · Tampa de vidro

| Ref | € | Ø (cm) | U.Venta |
|-------|-------|--------|---------|
| 27920 | 9,20 | 20 | 1 |
| 27924 | 10,60 | 24 | 1 |
| 27928 | 13,00 | 28 | 1 |

Grill

Grill · Grill Induktionfähig
Grill · Grelhador

| Ref | € | cm | Ød (cm) | h(cm) | U.Venta |
|-------|-------|-------|---------|-------|---------|
| 27625 | 44,80 | 24x24 | 18,6 | 4,8 | 1 |
| 27629 | 51,90 | 28x28 | 21,5 | 5,2 | 1 |



Titanium PRO Collection



- Cacerola robusta y duradera gracias a su cuerpo fabricado en aluminio fundido.
- Fabricada en una sola pieza.
- Libre de materiales pesados y tóxicos. ECO y libre de PFOA.
- Compatible con todas las fuentes de calor, incluida la inducción.
- Fácil limpieza interior y exterior.

- Casserole robuste et durable grâce à son corps fabriqué en fonte d'aluminium.
- Fabriquée en une seule pièce.
- Sans matériaux lourds et toxiques. ECO et sans PFOA.
- Compatible avec toutes les sources de chaleur, y compris l'induction.
- Nettoyage intérieur et extérieur facile.

- Robust and durable casserole thanks to its cast aluminium body.
- One piece construction.
- Free of heavy and toxic materials. ECO and PFOA-free.
- Compatible with all heat sources, including induction.
- Easy to clean interior and exterior.

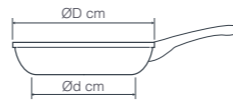

High release topcoat
Partially reinforced midcoat
Reinforced primer
(titanium-based particles)
Metal substrate

PPG QuanTanium™
Titanium-reinforced non-stick coating

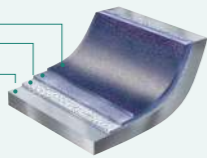

Antiadherente QuanTanium® reforzado con partículas de titanio; libre de materiales tóxicos y pesados, ecológico y libre de PFOA

Antiadhésif QuanTanium® renforcé avec des particules de titane sans matériaux toxiques ni métaux lourds, écologique et sans PFOA.
QuanTanium® non-stick reinforced with titanium particles; free from toxic and heavy materials, environmentally friendly and PFOA-free.



Asas EXTRAÍBLES fabricadas en silicona de máxima calidad, termoaislantes, altamente resistentes y ergonómicas, permiten un agarre seguro. Mango con acabado SOFT TOUCH, termoaislante, altamente resistente y ergonómico, permite un agarre seguro.

Heat insulating, highly resistant, ergonomic REMOVABLE handles made of high quality silicone which provide a secure grip on pots and pans. Handle with SOFT TOUCH finish, heat insulating, highly resistant and ergonomic, allows a secure grip.

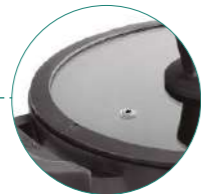

Tapa de vidrio templado reforzada con un aro protector de silicona antipactos y una válvula de salida de vapor.

Tempered glass lid reinforced with an anti-shock silicone protective ring and a steam outlet valve.



FULL INDUCTION; asegura un rendimiento óptimo en todo tipo de cocinas, con un reparto de calor inmejorable logrando la máxima eficiencia y ahorro de energía.

FULL INDUCTION diffuser base ensures optimum performance with all kinds of cookers. Its unbeatable heat distribution achieves the best efficiency and energy savings.

Incluye asas silicona
Includes silicone handles



Cacerola con tapa

Faitout avec couvercle · Bratentopf mit Deckel
Casserole with lid · Çaçarola com tampa

| Ref | € | Ø (cm) | h(cm) | e (mm) | L | U.Venta |
|-------|-------|--------|-------|--------|------|---------|
| 27520 | 52,00 | 20 | 9,5 | 2,0 | 2,60 | 1 |
| 27524 | 62,90 | 24 | 11,0 | 2,0 | 4,40 | 1 |
| 27528 | 76,50 | 28 | 12,0 | 2,0 | 6,60 | 1 |

Incluye asas silicona
Includes silicone handles



Tartera con tapa

Plat rond avec couvercle · Pfanne mit Deckel
Round dish with lid · Tarteira com tampa

| Ref | € | Ø (cm) | h(cm) | e (mm) | L | U.Venta |
|-------|--------|--------|-------|--------|------|---------|
| 27728 | 71,60 | 28 | 7,5 | 2,0 | 4,10 | 1 |
| 27732 | 85,90 | 32 | 8,0 | 2,0 | 5,70 | 1 |
| 27736 | 101,20 | 36 | 8,0 | 2,0 | 7,30 | 1 |



Grill

Grill · Grill Induktionfähig
Grill · Grelhador

| Ref | € | cm | h(cm) | e (mm) | U.Venta |
|-------|-------|-------|-------|--------|---------|
| 27827 | 54,90 | 28x28 | 4,0 | 1,8 mm | 1 |

Aro protector de silicona
Silicone protective ring



Tapa

Couvercle en verre · Glasdeckel
Glass lid · Tampa de vidro

| Ref | € | Ø (cm) | U.Venta |
|-------|-------|--------|---------|
| 27420 | 10,70 | 20 | 1 |
| 27424 | 12,40 | 24 | 1 |
| 27428 | 14,40 | 28 | 1 |
| 27432 | 16,30 | 32 | 1 |
| 27436 | 18,20 | 36 | 1 |



Cazo

Casserole · Stielkasserolle, flach
Saucepan · Çaçarola direite

| Ref | € | Ø (cm) | h(cm) | e (mm) | L | U.Venta |
|-------|-------|--------|-------|--------|------|---------|
| 27516 | 30,10 | 16 | 8,0 | 1,9 | 1,35 | 1 |



Sartén

Poêle · Pfanne
Frying-pan · Sertã

| Ref | € | Ø (cm) | Ød (cm) | h(cm) | e (mm) | U.Venta |
|-------|-------|--------|---------|-------|--------|---------|
| 27820 | 31,50 | 20 | 16,6 | 5,0 | 1,9 | 6 |
| 27824 | 38,80 | 24 | 20,2 | 5,5 | 1,9 | 4 |
| 27828 | 47,10 | 28 | 23,4 | 6,0 | 1,9 | 6 |



Sartén 4 cavidades

Poêle 4 cavités · Pfanne, 4-fache Einteilung
Frying-pan 4 cavities · Sertã 4 cavidades

| Ref | € | cm | h(cm) | e (mm) | U.Venta |
|-------|-------|-------|-------|--------|---------|
| 27832 | 47,50 | 32x26 | 3,5 | 1,9 | 1 |

SI
Silicone

Asas

Poignées · Griffchutz, Silikon
Handles · Asas

| Ref | € | Ø (cm) | U.Venta |
|---------|------|--------|---------|
| R27520A | 4,40 | 20 | 1 |
| R27528A | 4,50 | 24-28 | 1 |
| R27732A | 5,60 | 32-36 | 1 |





Fit Collection



- **Tratamiento electrolítico, el aluminio se sella completamente y se endurece para que no pase a los alimentos.**
- **Gran durabilidad y ultrarresistente: superficie robusta altamente resistente a roces, deformación y corrosión.**
- **Difunde el calor de forma uniforme evitando el sobrecalentamiento y obteniendo excelentes resultados de cocción.**
- **Mangos / Asas de acero inoxidable con remaches de aluminio que impiden la transferencia de calor.**
- **Tapas de vidrio templado reforzadas en el borde con acero inoxidable.**
- **Compatible con todas las fuentes de calor, incluida la inducción.**

- **Traitement électrolytique, l'aluminium est totalement scellé et durci pour ne pas pouvoir atteindre les aliments.**
- **Grande durabilité et ultra résistante : Surface robuste hautement résistante aux rayures, à la déformation et à la corrosion.**
- **Diffuse la chaleur de façon uniforme, évitant ainsi la surchauffe et obtenant d'excellents résultats de cuisson.**
- **Anses et poignées en acier inoxydable avec des rivets en aluminium qui empêchent le transfert de chaleur.**
- **Couvercles en verre trempé renforcés avec le bord en acier inoxydable.**
- **Compatible avec toutes les sources de chaleur, y compris l'induction.**

- **Electrolytic treatment, the aluminium is completely sealed and hardened so no metal is passed on to the food.**
- **Extremely durable and ultra-high strength: It has a robust surface that is highly resistant to abrasion, warping and corrosion.**
- **It distributes heat evenly to avoid overheating and provide excellent cooking results.**
- **Stainless steel handles with aluminium rivets that avoid heat transfer.**
- **The lid is tempered glass with stainless steel reinforcement around the edge.**
- **Compatible with all heat sources, including induction.**

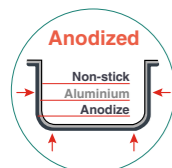

Anodized
Capa de óxido natural de protección muy gruesa.
Couche d'oxydation naturelle de protection très épaisse.
Thick natural oxide protective layer.



Abrasion
Muy resistentes a arañazos, deformaciones y corrosión.
Très résistante aux rayures, à la déformation et à la corrosion.
Very resistant to scratches, deformation and corrosion.

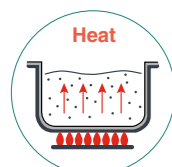

Heat
Distribuye uniformemente el calor, sin áreas de sobrecalentamientos.
Distribue uniformément la chaleur, sans zones de surchauffe.
Hot spot free, uniform heat distribution.

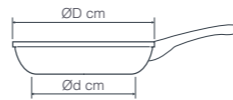

High release topcoat
Partially reinforced midcoat
Reinforced primer (titanium-based particles)
Metal substrate



Antiadherente QuanTanium® reforzado con partículas de titanio; libre de materiales tóxicos y pesados, ecológico y libre de PFOA
Antiadhésif QuanTanium® renforcé avec des particules de titane sans matériaux toxiques ni métaux lourds, écologique et sans PFOA.
QuanTanium® non-stick reinforced with titanium particles; free from toxic and heavy materials, environmentally friendly and PFOA-free.



Cacerola con tapa

Faitout avec couvercle · Bratentopf mit Deckel
Casserole with lid · Caçarola com tampa

| Ref | € | Ø (cm) | h(cm) | e (mm) | L | U.Venta |
|-------|-------|--------|-------|--------|------|---------|
| 48016 | 43,80 | 16 | 8,0 | 4,5 | 1,50 | 1 |
| 48020 | 53,10 | 20 | 9,0 | 4,5 | 2,60 | 1 |
| 48024 | 65,20 | 24 | 10,0 | 4,5 | 4,20 | 1 |
| 48028 | 76,60 | 28 | 11,0 | 4,5 | 6,30 | 1 |



Olla con tapa

Marmite avec couvercle · Fleichtopf mit Deckel
Stock pot with lid · Panela com tampa

| Ref | € | Ø (cm) | h(cm) | e (mm) | L | U.Venta |
|-------|-------|--------|-------|--------|-------|---------|
| 48116 | 50,40 | 16 | 13,0 | 4,5 | 2,50 | 1 |
| 48120 | 59,70 | 20 | 14,0 | 4,5 | 4,20 | 1 |
| 48124 | 75,00 | 24 | 15,0 | 4,5 | 6,50 | 1 |
| 48128 | 89,60 | 28 | 17,0 | 4,5 | 10,00 | 1 |



Cazo

Casserole · Stielkasserolle, flach
Saucepan · Caçarola direite

| Ref | € | Ø (cm) | h(cm) | e (mm) | L | U.Venta |
|-------|-------|--------|-------|--------|------|---------|
| 48214 | 30,40 | 14 | 7,5 | 4,5 | 1,00 | 1 |
| 48216 | 33,90 | 16 | 8,0 | 4,5 | 1,50 | 1 |
| 48218 | 38,10 | 18 | 9,0 | 4,5 | 2,10 | 1 |
| 48220 | 43,10 | 20 | 10,0 | 4,5 | 2,90 | 1 |



Tartera con tapa

Plat rond avec couvercle · Pfanne mit Deckel
Round dish with lid · Tarteira com tampa

| Ref | € | Ø (cm) | h(cm) | e (mm) | L | U.Venta |
|-------|-------|--------|-------|--------|------|---------|
| 48624 | 58,90 | 24 | 7,0 | 4,5 | 2,90 | 1 |
| 48628 | 70,40 | 28 | 8,0 | 4,5 | 4,50 | 1 |

Aro protector de acero inoxidable
Stainless steel protective ring

Vidrio templado
Tempered glass

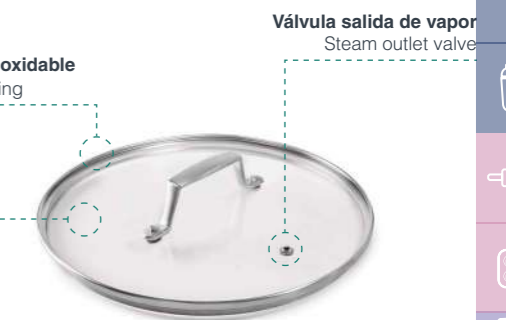

CRISTAL Glass
INOX
Dishwasher

Tapa

Couvercle · Deckel
Lid · Tampa

| Ref | € | Ø (cm) | U.Venta |
|-------|-------|--------|---------|
| 48916 | 12,30 | 16 | 1 |
| 48920 | 13,90 | 20 | 1 |
| 48924 | 15,30 | 24 | 1 |
| 48928 | 17,00 | 28 | 1 |



Sartén

Poêle · Pfanne
Frying pan · Sertã

| Ref | € | Ø (cm) | Ød (cm) | h(cm) | e (mm) | U.Venta |
|-------|-------|--------|---------|-------|--------|---------|
| 48720 | 33,20 | 20 | 15,0 | 4,0 | 4,5 | 6 |
| 48724 | 41,50 | 24 | 18,0 | 4,5 | 4,5 | 6 |
| 48728 | 49,50 | 28 | 22,0 | 5,0 | 4,5 | 6 |



HINWEIS: In Deutschland nicht verfügbar

Cocottes Collection



- Fabricada en aluminio fundido. Diseño atractivo y funcional.
- Garantiza la absorción y distribución uniforme del calor, sin puntos de sobrecalentamiento.
- La distribución del calor uniforme por toda la pieza hace que los alimentos no pierdan su jugo durante la cocción, conservando así todos sus nutrientes y vitaminas.
- Las puntas situadas bajo la tapa, hacen que las gotas fruto de la condensación, vuelvan a caer sobre los alimentos formando un lujo circulante y permanente reduciendo la pérdida de sabores y jugos de los alimentos.
- Es la pieza perfecta para: arroces, carnes, pescados, legumbres, verduras, guisos, cremas, salsas, sopas, etc.
- Revestimiento antiadherente ILAG:ULTIMATE.

- Fabriqué en aluminium fondu. Conception attrayante et fonctionnelle.
- Il garantit l'absorption et la distribution uniformes de la chaleur, sans surchauffe.
- La distribution de la chaleur uniforme dans toute la pièce fait que les aliments ne perdent pas leur jus pendant la cuisson, conservant ainsi tous ses nutriments et vitamines.
- Les conseils sous le couvercle, font les gouttes résultant de la condensation, tombent à nouveau dans des aliments formant un luxe en circulation et permanent réduisant la perte de saveurs et de jus de nourriture.
- C'est la pièce parfaite pour: le riz, les viandes, le poisson, les légumineuses, les légumes, les ragoûts, les crèmes, les sauces, les soupes, etc.
- Ilag: Ultime.

- Manufactured in molten aluminum. Attractive and functional design.
- It guarantees the uniform absorption and distribution of heat, without overheating points.
- The distribution of uniform heat throughout the piece causes food not to lose their juice during cooking, thus retaining all its nutrients and vitamins.
- The tips under the lid, make the drops resulting from condensation, fall again on food forming a circulating and permanent luxury reducing the loss of flavors and food juices.
- It is the perfect piece for: rice, meats, fish, legumes, vegetables, stews, creams, sauces, soups, etc.
- Ilag: Ultimate.



Cacerola con tapa Mini

Faitout avec couvercle "MINI" · "MINI" Bratentopf mit Deckel
"MINI" round casserole with lid · Caçarola com tampa "MINI"

| | Ref | € | Ø (cm) | h(cm) | L | U.Venta |
|---|-------|-------|--------|-------|------|---------|
| A | 25909 | 23,10 | 10 | 5,0 | 0,24 | 12 |
| | 25914 | 33,90 | 14 | 7,5 | 0,90 | 1 |
| B | 25910 | 23,10 | 10 | 5,0 | 0,24 | 1 |
| | 25915 | 33,90 | 14 | 7,5 | 0,90 | 1 |



Cacerola oval con tapa Mini

Faitout Ovale avec couvercle "MINI" · "MINI" Oval Bratentopf mit Deckel
"MINI" oval round casserole with lid · Caçarola oval com tampa "MINI"

| | Ref | € | Ø (cm) | h(cm) | L | U.Venta |
|---|-------|-------|--------|-------|------|---------|
| A | 25911 | 24,30 | 12x8,5 | 5,0 | 0,25 | 1 |
| B | 25912 | 23,00 | 12x8,5 | 5,0 | 0,25 | 1 |



Cacerola con tapa

Faitout avec couvercle · Bratentopf mit Deckel
Round casserole with lid · Caçarola com tampa

| | Ref | € | Ø (cm) | h(cm) | L | U.Venta |
|---|-------|--------|--------|-------|------|---------|
| | 25916 | 49,90 | 16 | 7,0 | 1,30 | 1 |
| A | 25920 | 65,00 | 20 | 8,0 | 2,40 | 1 |
| | 25924 | 83,90 | 24 | 10,0 | 4,20 | 1 |
| | 25928 | 107,00 | 28 | 11,5 | 6,70 | 1 |
| B | 25917 | 55,50 | 16 | 7,0 | 1,30 | 1 |
| | 25921 | 73,20 | 20 | 8,0 | 2,40 | 1 |
| | 25925 | 91,50 | 24 | 10,0 | 4,20 | 1 |
| | 25929 | 112,00 | 28 | 11,5 | 6,70 | 1 |



Cacerola oval con tapa

Faitout Ovale avec couvercle · Oval Bratentopf mit Deckel
Oval round casserole with lid · Caçarola oval com tampa

| | Ref | € | cm | h(cm) | L | U.Venta |
|---|-------|--------|-------|-------|------|---------|
| A | 25927 | 77,40 | 26x20 | 9,0 | 3,50 | 1 |
| | 25931 | 106,20 | 31x25 | 11,0 | 6,30 | 1 |
| B | 25933 | 83,50 | 26x20 | 9,0 | 3,50 | 1 |
| | 25935 | 115,10 | 31x25 | 11,0 | 6,30 | 1 |



Cazo

Casserole · Stielkasserole, flach
Saucepan · Caçarola direite

| | Ref | € | Ø (cm) | Ød (cm) | h(cm) | e (mm) | L | U.Venta |
|--|-------|-------|--------|---------|-------|--------|------|---------|
| | 25956 | 30,50 | 16 | 12,0 | 8,0 | 1,6 | 1,30 | 1 |
| | 25958 | 34,20 | 18 | 15,0 | 8,5 | 1,6 | 1,80 | 1 |
| | 25950 | 37,50 | 20 | 16,5 | 9,0 | 1,6 | 2,40 | 1 |

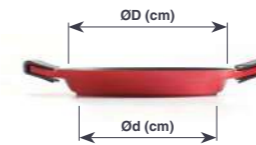

Incluye asas de silicona
Includes silicone handles



Paellera

Plat rond · Pfanne
Round · Paelheira

| | Ref | € | Ø (cm) | Ød (cm) | h(cm) | e (mm) | Raciones | U.Venta |
|--|-------|--------|--------|---------|-------|--------|----------|---------|
| | 25932 | 84,30 | 32 | 25,5 | 4,5 | 1,6 | 5 | 1 |
| | 25936 | 98,50 | 36 | 29,5 | 4,5 | 2,0 | 7 | 1 |
| | 25940 | 109,50 | 40 | 33,5 | 4,5 | 2,0 | 9 | 1 |

Manoplas de silicona

Mouffettes en silicone · Griffchutz aus Silikon
Silicone mittens · Pegas de silicone

| | Ref | € | Ø (cm) | U.Venta |
|--|---------|------|----------------|---------|
| | R25917G | 8,40 | 16 | 6 |
| | R25933G | 8,40 | 20-24-28-26x20 | 6 |
| | R25935G | 8,00 | 31x25 | 6 |

- Fabricada en aluminio fundido.
- Garantiza la absorción y distribución uniforme del calor, sin puntos de sobrecalentamiento.
- La distribución del calor uniforme por toda la pieza hace que los alimentos no pierdan su jugo durante la cocción, conservando así todos sus nutrientes y vitaminas.
- Fondo difusor FULL INDUCTION; asegura un rendimiento óptimo en todo tipo de cocinas con un reparto de calor inmejorable logrando la máxima eficiencia y ahorro de energía.
- Perfecta para arroces, carnes, pescados, legumbres, verduras, guisos, cremas, salsas, sopas, etc.
- Revestimiento antiadherente Xylan Plus.
- Diseño atractivo y funcional.
- Compatible con todo tipo de cocinas, incluida la inducción.
- Manufactured in molten aluminum.
- It guarantees the uniform absorption and distribution of heat, without overheating points.
- The distribution of uniform heat throughout the piece causes food not to lose their juice during cooking, thus retaining all its nutrients and vitamins.
- Full Induction Diffuser Fund; ensures optimal performance in all types of kitchens with an unbeatable heat distribution achieving maximum efficiency and energy saving.
- Perfect for rice, meats, fish, legumes, vegetables, stews, creams, sauces, soups, etc.
- Antiating Coating Xylan Plus.
- Attractive and functional design.
- Compatible with all types of kitchens, including induction.



Mini Collection



- Fabricadas en aluminio fundido de máxima calidad.
- Ideal tanto para cocinar como para presentar aperitivos o platos.
- Antiadherente bicapa de alta calidad y 100% libre de PFOA.
- Libres de materiales tóxicos, pesados, disolventes y sustancias químicas.
- Diseñadas para una cocina saludable: permite cocinar sin apenas aceite garantizando que los alimentos no se peguen.
- Distribución homogénea del calor que permite una cocción rápida y uniforme.
- Aptas para todo tipo de fuegos: gas, eléctrica, vitrocerámica e inducción.
- Tapa fabricada en vidrio templado con válvula desalida de vapor.
- Pomo baquelita con acabado Soft Touch.
- Mango ergonómico con acabado Soft Touch.

- Fabriqué en fonte d'aluminium de la plus grande qualité.
- Idéale aussi bien pour cuisiner que pour la d'apéritifs ou de plats.
- Finition antiadhésive bi-couche de grande qualité et 100% sans PFOA.
- Sans matériaux toxiques, métaux lourds, dissolvants et substances chimiques.
- Conçue pour une cuisine saine : permet de cuisiner sans à peine utiliser d'huile et avec la garantie que les aliments ne collent pas.
- Distribution homogène de la chaleur, ce qui permet une cuisson rapide et uniforme.
- Apte pour tous types de feux : gaz, électricité, vitroceramique, four et induction.
- Couvercle fabriqué en verre trempé avec valve à vapeur.
- Poignée en bakélite avec finition Soft Touch.
- Manche ergonomique avec finition Soft Touch.

- Made from a single piece of top quality cast aluminium.
- It's perfect for both cooking and presenting appetisers or dishes.
- It has a high quality bi-layer non-stick coating that is 100% PFOA free.
- It's free of toxic materials, heavy metals, solvents and chemical substances.
- It's designed for healthy cooking. It lets you cook with practically no oil and be sure that food won't stick.
- Food is cooked quickly and evenly because of the homogeneous heat distribution.
- It's suitable for all kinds of cookers: gas, electric, vitroceramic, oven and induction.
- The lid is made of tempered glass with a steam valve.
- Bakelite handle with a Soft Touch finish.
- Ergonomic handle with a Soft Touch finish.

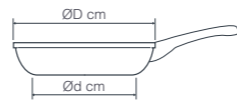

Cacerola con tapa

Faitout avec couvercle · Bratentopf mit Deckel
Casserole with lid · Caçarola com tampa

| Ref | € | Ø (cm) | Ød (cm) | h(cm) | L | U.Venta |
|-------|-------|--------|---------|-------|-----|---------|
| 25160 | 21,50 | 16 | 12 | 5,0 | 0,8 | 1 |



Cazo

Casserole · Stielkasserole, flach
Saucepan · Caçarola direite

| Ref | € | Ø (cm) | Ød (cm) | h(cm) | L | U.Venta |
|-------|-------|--------|---------|-------|-----|---------|
| 25164 | 16,60 | 14 | 10 | 8,0 | 1,0 | 1 |



Paellera

Plat à paella · Pfanne
Round dish · Paelheira

| Ref | € | Ø (cm) | Ød (cm) | h(cm) | L | U.Venta |
|-------|-------|--------|---------|-------|-----|---------|
| 25161 | 21,50 | 20 | 11,5 | 4,5 | 1,0 | 1 |



Sartén

Poêle · Pfanne
Frying pan · Sertä

| Ref | € | Ø (cm) | Ød (cm) | h(cm) | U.Venta |
|-------|-------|--------|---------|-------|---------|
| 25163 | 13,20 | 14 | 10,0 | 3,0 | 1 |



Grill

Grill · Grill Induktionfähig
Grill · Grelhador

| Ref | € | cm | Ød (cm) | h(cm) | U.Venta |
|-------|-------|-------|---------|-------|---------|
| 25162 | 14,50 | 14x14 | 10,0 | 2,5 | 1 |



Smart Collection



- Cacerola y paellera de hierro muy resistentes.
- Cubiertas con una capa de esmalte vitricado antiácido de máxima calidad.
- Asas altamente reforzadas.
- Perfectas para presentar y servir sabrosas tapas, raciones o pinchos.

- Faitout et poêle à paella en fer très résistantes.
- Possèdes un revêtement avec une couche d'acier émaillé de la plus grande qualité.
- Anses hautement renforcées.
- Parfaites pour présenter et servir de savoureuses tapas, de petites portions ou des amuse-bouches.

- Extremely strong metal casserole and paella dish.
- Coated with a layer of top quality antacid vitrified enamel.
- Heavily reinforced handles.
- Perfect for serving or presenting delicious tapas, dishes or pinchos.



Cacerola

Faitout à paella · Bratentopf, emailiert
Casserole · Caçarola esmaltada

| Ref | € | Ø (cm) | h(cm) | U.Venta |
|-------|------|--------|-------|---------|
| 60192 | 6,70 | 12 | 4,0 | 1 |
| 60196 | 7,90 | 16 | 4,5 | 1 |
| 60190 | 8,70 | 20 | 4,7 | 1 |



Paellera

Plat à paella · Paellapfanne, emailiert
Round dish for paelle · Paelheira esmaltada

| Ref | € | Ø (cm) | U.Venta |
|-------|------|--------|---------|
| 60170 | 5,20 | 10 | 1 |
| 60172 | 5,90 | 12 | 1 |
| 60175 | 6,90 | 15 | 1 |
| 60180 | 8,80 | 20 | 1 |

Magma Collection



- Construida en una sola pieza.
- Recubierta con una capa de aceite vegetal.
- Ideal para cocinar, prolonga suavemente la cocción.
- Gran conductor del calor, mantiene el calor mientras disfrutas y saboreas la comida.
- Base de madera para servir y presentar la comida recién cocinada.

- Construit en un seul morceau.
- Recouvert d'une couche d'huile végétale.
- Idéal pour la cuisine, la cuisine doucement prolongée.
- Excellent conducteur de chaleur, gardez la chaleur tout en profitant et sauvant la nourriture.
- Base de bois pour servir et présenter des aliments fraîchement cuits.

- Built in one piece.
- Covered with a layer of vegetable oil.
- Ideal for cooking, gently prolonged cooking.
- Great heat driver, keep heat while enjoying and savors the food.
- Wood base to serve and present freshly cooked food.



Cacerola

Faitout · Bratentopf
Casserola · Caçarola

| Ref | € | Ø (cm) | ml | U.Venta |
|-------|-------|--------|-----|---------|
| 25771 | 11,00 | 12,5 | 230 | 4 |
| 25772 | 16,00 | 16,2 | 470 | 4 |
| 25773 | 19,30 | 18,5 | 720 | 1 |



Cacerola con base

Faitout avec basse · Bratentopf mit Holzsockel
Casserola with base · Caçarola com base

| Ref | € | Ø (cm) | ml | U.Venta |
|-------|-------|--------|-----|---------|
| 25871 | 15,80 | 12,5 | 230 | 4 |
| 25872 | 21,60 | 16,2 | 470 | 1 |
| 25873 | 27,70 | 18,5 | 720 | 1 |



Cacerola oval

Faitout ovale · Oval Bratentopf
Oval casserola · Caçarola oval

| Ref | € | cm | ml | U.Venta |
|-------|-------|-----------|-----|---------|
| 25781 | 12,40 | 15x10 | 200 | 4 |
| 25782 | 19,50 | 17,5x12,5 | 300 | 1 |
| 25783 | 22,20 | 21,7x15 | 700 | 1 |



Cacerola oval con base

Faitout ovale avec basse · Oval Bratentopf mit Holzsockel
Oval casserola with base · Caçarola oval com base

| Ref | € | cm | ml | U.Venta |
|-------|-------|-----------|-----|---------|
| 25881 | 16,00 | 15x10 | 200 | 4 |
| 25882 | 24,70 | 17,5x12,5 | 300 | 1 |
| 25883 | 27,40 | 21,7x15 | 700 | 1 |



Mini plancha rectangular

Mini plaque grill lisse rectangulaire · Mini Platte Grill, glatt, rechteckiger
Mini rectangular grill plaque flat · Mini plancha grill liso rectangular

| Ref | € | cm | U.Venta |
|-------|-------|-------|---------|
| 25774 | 10,50 | 17x10 | 4 |



Mini plancha rectangular con base

Mini plaque Grill lisse rectang. a/basse · Mini Platte Grill, glatt, rechteckiger m/Holzsockel
Mini rectangular grill plaque flat with base · Mini plancha grill liso rectangular c/base

| Ref | € | cm | h(cm) | U.Venta |
|-------|-------|-------|-------|---------|
| 25874 | 15,40 | 17x10 | 2,5 | 4 |



Mini plancha grill cuadrado

Mini plaque grill carré · Mini Platte Grill, Quadrat
Mini square grill plaque · Mini plancha grill quadrado

| Ref | € | cm | h(cm) | U.Venta |
|-------|-------|-------|-------|---------|
| 25775 | 11,00 | 14x14 | 1,7 | 4 |



Mini grill

Mini grill · Mini Grill
Mini grill · Mini grill

| Ref | € | cm | h(cm) | U.Venta |
|-------|-------|-------|-------|---------|
| 25776 | 11,40 | 14x14 | 2,5 | 4 |



Mini sartén lisa

Mini poêle lisse · Mini Pfanne
Mini frying pan flat · Mini sertã lisa

| Ref | € | Ø (cm) | h(cm) | U.Venta |
|-------|-------|--------|-------|---------|
| 25777 | 11,50 | 13 | 1,7 | 4 |



Mini plancha grill cuadrado con base

Mini plaque grill carré avec basse · Mini Platte Grill, Quadrat mit Holzsockel
Mini square grill plaque with base · Mini plancha grill quadrado com base

| Ref | € | cm | h(cm) | U.Venta |
|-------|-------|-------|-------|---------|
| 25875 | 15,40 | 14x14 | 1,7 | 4 |



Mini grill con base

Mini grill avec basse · Mini Grill mit Holzsockel
Mini grill with base · Mini grill com base

| Ref | € | cm | h(cm) | U.Venta |
|-------|-------|-------|-------|---------|
| 25876 | 17,80 | 14x14 | 2,5 | 1 |



Mini sartén lisa con base

Mini poêle lisse avec basse · Mini Pfanne mit Holzsockel
Mini frying pan flat with base · Mini sertã lisa com base

| Ref | € | Ø (cm) | h(cm) | U.Venta |
|-------|-------|--------|-------|---------|
| 25877 | 16,50 | 13 | 1,7 | 1 |

Mango desmontable
Removable handle



Bandeja oval con mango y base MAGMA

Plateau ovale avec manche et base · Ovale tablett mit griff und basis
Oval tray with handle and base · Bandeja oval com cabo e base

| Ref | € | cm | h (cm) | U.Venta |
|-------|-------|-------|--------|---------|
| 25867 | 18,10 | 24x14 | 2,2 | 1 |

- Bandeja oval con mango desmontable fabricada en hierro fundido de gran calidad.
- Recubierta con una capa de aceite vegetal.
- Base de madera natural, diseñada para servir y presentar la comida recién cocinada.
- Versátil: Diseñado para cocinar todo tipo de alimentos tanto en cocinas interiores (inducción, vitro, gas, horno) como en exteriores (parrillas, barbacoas, planchas)
- Se calientan rápidamente, transmiten y conservan muy bien el calor y aguantan altas temperaturas.

- Plateau ovale avec manche démontable fabriqué en fonte de grande qualité.
- Recouvert d'une couche d'huile végétale.
- Base en bois naturel ; conçu pour servir et présenter la nourriture fraîchement préparée.
- Versatile : conçu pour cuire tout type d'aliments sur des sources de chaleur aussi bien à l'intérieur (induction, vitrocéramique, gaz, four) qu'à l'extérieur (grills, barbecues, planchas).
- Chauffe rapidement, transmet et conserve très bien la chaleur et résiste à de hautes températures.

- Oval tray with detachable handle made of high quality cast iron.
- Coated with a layer of vegetable oil.
- Natural wood base, designed for serving and presenting freshly cooked food.
- Fully versatile: designed for cooking all types of food, both indoors (induction, vitro, gas, oven) and outdoors (grills, barbecues, griddles).
- They heat up quickly, transmit and retain heat very well and withstand high temperatures.



Magma Grey & Red



- Acabado exterior e interior esmaltado, muy resistente y de gran durabilidad.
- Muy versátil: ideal para cocinar asados, arroces, pasta, cocer a fuego lento e incluso hornear tartas dulces y pan.
- Conserva todos los nutrientes, vitaminas y sabores de los alimentos.
- Excelente retención y distribución uniforme del calor.
- Incluye base de madera, ideal para servir y presentar.

- Apta para todo tipo de fuegos. Finition émaillée extérieure et intérieure, très résistante et d'une grande durabilité.
- Très polyvalent: idéal pour cuisiner des rôtis, du riz, des pâtes, cuire à feu doux et même cuire des gâteaux sucrés et à pain.
- Gardez tous les nutriments, vitamines et saveurs des aliments.
- Excellente rétention et distribution uniforme de la chaleur.
- Comprend la base en bois, idéale pour servir et présenter.

- Convient à tous les types d'incendies. Exterior and interior enameled finish, very resistant and of great durability.
- Very versatile: Ideal for cooking roasts, rice, pasta, cook over low heat and even bake sweet and bread cakes.
- Keep all nutrients, vitamins and flavors of food.
- Excellent retention and uniform distribution of heat.
- Includes wood base, ideal to serve and present.
- Suitable for all types of fires.



Cacerola redonda

Faitout rond · Rund Bratentopf
Round casserole · Caçarola redonda

| | Ref | € | Ø (cm) | h(cm) | ml | U.Venta |
|---|-------|-------|--------|-------|-----|---------|
| A | 25841 | 18,10 | 12,0 | 3,0 | 200 | 1 |
| | 25848 | 28,10 | 16,2 | 3,0 | 470 | 1 |
| | 25849 | 34,80 | 18,5 | 3,0 | 720 | 1 |
| B | 25851 | 18,10 | 12,0 | 3,0 | 200 | 1 |
| | 25858 | 28,10 | 16,2 | 3,0 | 470 | 1 |
| | 25859 | 34,80 | 18,5 | 3,0 | 720 | 1 |

Cacerola oval

Faitout ovale · Oval Bratentopf
Oval casserole · Caçarola oval

| | Ref | € | cm | h(cm) | ml | U.Venta |
|---|-------|-------|-----------|-------|-----|---------|
| A | 25842 | 24,10 | 17,5x12,5 | 3,0 | 250 | 1 |
| | 25840 | 34,70 | 21,7x15 | 3,0 | 700 | 1 |
| B | 25852 | 24,30 | 17,5x12,5 | 3,0 | 250 | 1 |
| | 25850 | 35,00 | 21,7x15 | 3,0 | 700 | 1 |



Sartén

Poêle · Pfanne
Frying pan · Sertä

| | Ref | € | Ø (cm) | h(cm) | ml | U.Venta |
|---|-------|-------|--------|-------|-----|---------|
| A | 25843 | 18,20 | 13,5 | 3,0 | 275 | 1 |
| B | 25853 | 18,20 | 13,5 | 3,0 | 275 | 1 |



Cacerola redonda con tapa

Faitout rond avec couvercle · Rund Bratentopf mit Deckel
Round casserole with lid · Caçarola redonda com tampa

| | Ref | € | Ø (cm) | h(cm) | ml | U.Venta |
|---|-------|-------|--------|-------|-----|---------|
| A | 25846 | 29,30 | 10 | 5,0 | 200 | 1 |
| B | 25856 | 29,30 | 10 | 5,0 | 200 | 1 |



Cacerola oval con tapa

Faitout ovale avec couvercle · Oval Bratentopf mit Deckel
Oval casserole with lid · Caçarola oval com tampa

| | Ref | € | cm | h(cm) | ml | U.Venta |
|---|-------|-------|-------|-------|-----|---------|
| A | 25847 | 34,70 | 13x10 | 5,0 | 400 | 1 |
| B | 25857 | 34,70 | 13x10 | 5,0 | 400 | 1 |



Ollas a presión

Pressure cookers



Sistema de apertura y cierre con una sola mano
Opening and closing system with one hand

Chef luxe



- Sistema de apertura y cierre con una sola mano.
- Selección de posiciones (3 posiciones: 0 - I - II).
- Se puede utilizar como una cacerola normal.
- Ouverture et de fermeture d'une seule main.
- Sélection positions(3 positions: 0 - I - II).
- Peut être utilisé comme une casserole normale.
- Opening and closing system with one hand.
- Selecting positions (3 position: 0 - I - II).
- Can be used as a normal casserole.



Olla a presión
Cocotte à pression · Schnellkochtopf
Pressure cooker · Panela de pressão

| Ref | € | Ø (cm) | h(cm) | L | U.Venta |
|-------|--------|--------|-------|------|---------|
| 50815 | 606,90 | 32 | 18,0 | 15,0 | 1 |
| 50818 | 624,60 | 32 | 23,0 | 20,0 | 1 |
| 50823 | 656,10 | 32 | 32,0 | 23,0 | 1 |



Cuerpo
Corps cocotte à pression · Schnellkochtopf-Körper
Pressure cooker stockpot · Corpo panela de pressão

| Ref | € | Ø (cm) | h(cm) | L | U.Venta |
|-------|--------|--------|-------|------|---------|
| 50816 | 209,50 | 32 | 18,0 | 15,0 | 1 |
| 50819 | 227,10 | 32 | 23,0 | 20,0 | 1 |
| 50824 | 258,70 | 32 | 32,0 | 23,0 | 1 |



Tapa
Couvercle · Deckel
Lid · Tampa

| Ref | € | Ø (cm) | U.Venta |
|---------|--------|--------|---------|
| A 50934 | 397,50 | 32 | 1 |
| B 54932 | 28,60 | 32 | 1 |

Robust

AL FUNDIDO
Aluminium Cast

Vitro Electric Gas Oven Dishwasher

- Diseñada para uso profesional.
- Fabricada en aluminio de máxima calidad (grado de pureza 99,55%).
- Especialmente indicada para cocinas de gas, eléctricas y vitrocerámicas.
- Excelente conductor térmico. Rápida y eficiente. Posee un elevado rendimiento energético (70%).
- Triple sistema de seguridad.
- Puente más robusto y resistente.
- Asas de baquelita antiquemaduras.

- Conçue pour un usage professionnel.
- Il est conçu en aluminium haute qualité (degré de pureté de 99,5 %).
- Adaptée aux gaz, cuisinières électriques et plaques de cuisson.
- Excellent conducteur thermique. Rapide et efficace. Confère un rendement énergétique élevé (70%).
- Triple système de sécurité.
- Pont plus robuste et résistant.

- Poignées en bakélite anti-brûlures.
- For Professional use.
- Made of high quality aluminium (with a 99.5% degree of purity).
- Suitable for gas, electric, cookers and cooktops.
- Excellent thermal conductivity. Fast and efficient. High energy performance (70%).
- Triple safety system.
- Stronger and more robust bridge.
- Anti-scald bakelite handles.



1 Triple sistema de seguridad
2 Triple safety system
3

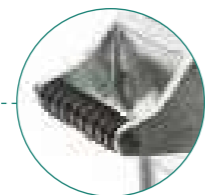

Asas de baquelita antiquemaduras
Anti-scald bakelite handles



Olla a presión

Cocotte à pression · Schnellkochtopf
Pressure cooker · Panela de pressão

| Ref | € | Ø (cm) | h(cm) | L | U.Venta |
|-------|---------|--------|-------|----|---------|
| 20830 | 1394,90 | 42 | 31 | 30 | 1 |
| 20840 | 1487,50 | 42 | 39 | 40 | 1 |
| 20850 | 1580,30 | 42 | 46 | 50 | 1 |



Pro Classic

AL INOX
Aluminium Vitro Electric Gas Oven Dishwasher

- Diseñada para uso profesional.
- Fabricada en aluminio.
- Especialmente indicada para cocinas de gas, eléctricas y vitrocerámicas.
- Excelente conductor térmico. Rápida y eficiente. Posee un elevado rendimiento energético (70%).
- Válvula de presión/contrapeso: permite que se libere el vapor regulando la presión interior de la olla. Válvula de seguridad/despresurización: actúa en caso en el que falle la válvula de presión.
- Puente más robusto y resistente.
- Asas de baquelita antiquemaduras.

- Conçue pour un usage professionnel.
- Fabriquée en aluminium.
- Adaptée aux gaz, cuisinières électriques et plaques de cuisson.
- Excellent conducteur thermique. Rapide et efficace. Confère un rendement énergétique élevé (70%).
- Soupape à pression/contrepois : permet de libérer la vapeur en régulant la pression intérieure de l'autocuiseur.
- Soupape de sécurité/dépressurisation : agit dans le cas d'un dysfonctionnement de la soupape à pression.
- Pont plus robuste et résistant.
- Poignées en bakélite anti-brûlures.

- For Professional use.
- Made of aluminium.
- Suitable for gas, electric, cookers and cooktops.
- Excellent thermal conductivity. Fast and efficient. High energy performance (70%).
- The pressure/counterweight valve lets steam escape and regulates pressure inside the pot.
- Safety/depressurisation valve: acts in case of failure of the pressure valve.
- Stronger and more robust bridge.
- Anti-scald bakelite handles.



Olla a presión

Cocotte à pression · Schnellkochtopf
Pressure cooker · Panela de pressão

| | Ref | € | Ø (cm) | h(cm) | L | U.Venta |
|---|-------|--------|--------|-------|------|---------|
| | 20511 | 114,60 | 28 | 22 | 11,0 | 1 |
| A | 20515 | 131,70 | 30 | 25 | 15,0 | 1 |
| | 20518 | 163,90 | 32 | 23 | 18,0 | 1 |
| | 20522 | 182,10 | 34 | 23 | 22,0 | 1 |
| B | 20533 | 217,70 | 36 | 32,0 | 33,0 | 1 |
| | 20540 | 236,10 | 40 | 32,5 | 40,0 | 1 |
| C | 20550 | 282,00 | 44 | 34,0 | 50,0 | 1 |

| | Válvula de seguridad Safety valve | Válvula de cocción Cooking valve |
|---|--------------------------------------|-------------------------------------|
| A | 1 | 1 |
| B | 1 | 2 |
| C | 2 | 2 |

Classic



- Fabricada en acero inoxidable 18/10 de máxima calidad.
- Marcaje interior, grabado con la capacidad del uso de la olla.
- Asas de baquelita antiquemaduras. Válvula de seguridad.
- Apta para todo tipo de cocinas. Triple fondo FULL INDUCTION para una distribución rápida y homogénea del calor.
- Las referencias 71872-71875 contienen un cestillo.

- Fabrication en acier inoxydable 18/10 de qualité maximale.
- Marquage intérieur, marquage gravé de la capacité d'utilisation de l'autocuiseur.
- Poignées en bakélite anti-brûlures. Soupape de sécurité.
- Apte pour tout type de feux. Triple fond FULL INDUCTION pour une distribution rapide et homogène de la chaleur.
- * Les références 71872-71875 contiennent un panier.

- Manufactured in high-quality 18/10 stainless steel.
- Inner marking, engraved with the cooker's capacity.
- Burn-resistant Bakelite handles Safety valve.
- Suitable for any type of hob. Tri-ply FULL INDUCTION base for quick, even heat distribution.
- * The 71872-71875 references contain a basket.

Válvula de seguridad
Safety valve



Marcajes de capacidad en litros
Capacity markings inside in litres



Asas de baquelita antiquemaduras
Anti-scald bakelite handles



Triple fondo difusor
Triple diffuser bottom



Olla a presión
Cocotte à pression · Schnellkochtopf
Pressure cooker · Panela de pressão

| Ref | € | Ø (cm) | h(cm) | e (mm) | L | U.Venta |
|-------|--------|--------|-------|--------|------|---------|
| 71874 | 89,00 | 22 | 11,5 | 1,2 | 4,0 | 1 |
| 71876 | 97,60 | 22 | 17,0 | 1,2 | 6,0 | 1 |
| 71878 | 106,70 | 24 | 19,0 | 1,2 | 8,0 | 1 |
| 71871 | 116,30 | 24 | 23,0 | 1,2 | 10,0 | 1 |
| 71872 | 183,50 | 26 | 23,0 | 1,2 | 12,0 | 1 |
| 71875 | 197,50 | 26 | 29,0 | 1,2 | 15,0 | 1 |



Genius



- Fabricada: acero inoxidable 18/10 de máxima calidad. Acabado pulido espejo exterior.
- Marcaje interior: Grabado con la capacidad del uso de la olla.
- Cierre fácil y seguro: Gracias a su asa ergonómica, es fácil y cómodo de abrir.
- Triple fondo difusor: Garantiza una óptima difusión del calor, favoreciendo un importante ahorro de energía (70%) y una cocción uniforme resaltando el aroma y sabor de los alimentos.
- Sistema de seguridad: Válvula de seguridad, actúa en caso de aumento excesivo de presión, despresurizando rápidamente la olla.
- Apta para todo tipo de cocinas y el lavavajillas.

- Fabrication : En acier inoxydable 18/10 de qualité maximale. Finition polissage miroir extérieur.
- Marquage intérieur : Marquage gravé de la capacité d'utilisation de l'autocuiseur.
- Fermeture facile et sûre : Grâce à son manche ergonomique, permet une ouverture simple et pratique.
- Triple fonds diffuseur : Garantit une diffusion optimale de la chaleur, favorisant ainsi d'importantes économies d'énergie (70%) et une cuisson uniforme accentuant l'odeur et le goût des aliments.
- Système de sécurité : Soupape de sécurité, agit en cas d'augmentation excessive de la pression, dépressurisant rapidement
- Apte pour tout type de cuisinières et le lave-vaisselle.

- Manufactured: High-quality 18/10 stainless steel. Exterior mirror-polished finish.
- Inner marking: Engraved with the cooker's capacity.
- Easy, safe closing: Thanks to its ergonomic handle, it's easy and convenient to open.
- Triple diffuser base: Ensures optimum heat diffusion, enabling a significant energy saving (70%) and even cooking that enhances the aroma and flavour of the food.
- Safety system: The safety valve operates in the case of an excessive increase in pressure, quickly releasing pressure from the cooker.
- Suitable for all types of cookers and dishwashers.

Olla a presión
Cocotte à pression · Schnellkochtopf
Pressure cooker · Panela de pressão

| Ref | € | Ø (cm) | h(cm) | L | U.Venta |
|-------|-------|--------|-------|------|---------|
| 71904 | 61,20 | 22 | 11,5 | 4,0 | 1 |
| 71906 | 67,50 | 22 | 17,0 | 6,0 | 1 |
| 71908 | 76,10 | 24 | 19,0 | 8,0 | 1 |
| 71901 | 84,30 | 24 | 23,0 | 10,0 | 1 |





Sistema de apertura y cierre con una sola mano
One-handed opening and closing mechanism

Nivel de cocción: 0 y 100kpa
Cooking level

Fondo termodifusor
Thermo-diffuser bottom



Sicuro



- Fabricada en acero inoxidable 18/10 de máxima calidad con acabado satinado.
- Fondo termodifusor sándwich; distribución rápida y uniforme del calor.
- Marcaje interior en litros.
- Asas termostables que aseguran un manejo cómodo y seguro.
- Ahorra un 70% de energía conservando el aroma y sabor de los alimentos.
- Nivel de cocción totalmente ajustable: gira el pomo y elige la presión entre 0 y 100kpa.
- Cierre fácil y 100% seguro: sistema de apertura y cierre con una sola mano.
- Triple sistema de seguridad: 1) Válvula de seguridad: actúa en caso de aumento excesivo de presión, despresurizando rápidamente la olla. 2) Sistema de bloqueo de seguridad: imposibilidad de apertura de la tapa mientras cocinamos. 3) Ventana lateral de seguridad.
- Compatible con todas las fuentes de calor, incluida la inducción. Cuerpo apto para el lavavajillas.

- Fabriqué en acier inoxydable 18/10 de qualité maximale avec finition en satin.
- Fond de thermodifusor sandwich; Distribution rapide et uniforme de la chaleur.
- Marquage intérieur en litres.
- Poignées résistantes aux thermorales qui garantissent une manipulation confortable et sûre.
- Économisez 70% d'énergie préservant l'arôme et le goût des aliments.
- Niveau de cuisson entièrement réglable: Tournez le bouton et choisissez la pression entre 0 et 100 kpa.
- Close d'assurance facile et 100%: système d'ouverture et de clôture d'une seule main.
- Système de sécurité triple: 1) Vanne de sécurité: agit en cas d'augmentation excessive de pression, décompressant rapidement le pot. 2) Système de blocage de sécurité: impossibilité d'ouvrir le couvercle pendant que nous cuisinons. 3) Fenêtre latérale de sécurité.
- Compatible avec toutes les sources de chaleur, y compris l'induction.

- Corps adapté au lave-vaisselle. Made of stainless steel 18/10 of maximum quality with satin finish.
- Sandwich thermodifusor background; Quick and uniform distribution of heat.
- Interior marking in liters.
- Thermor resistant handles that ensure comfortable and safe handling.
- Save 70% energy preserving the aroma and taste of food.
- Fully adjustable cooking level: Turn the knob and choose the pressure between 0 and 100kpa.
- Easy and 100% Insurance closure: Opening and closing system with one hand.
- Triple Security System: 1) Safety valve: Acts in case of excessive pressure increase, rapidly discouraging the pot. 2) Safety blocking system: Impossibility of opening the lid while we cook. 3) Security side window.
- Compatible with all heat sources, including induction. Body suitable for dishwasher.



Olla a presión

Cocotte à pression · Schnellkochtopf
Pressure cooker · Painela de pressão

| Ref | € | Ø (cm) | h(cm) | L | U.Venta |
|-------|--------|--------|-------|-----|---------|
| 71784 | 204,60 | 22 | 11,0 | 4,0 | 1 |
| 71786 | 210,70 | 22 | 16,0 | 6,0 | 1 |
| 71788 | 221,50 | 22 | 21,1 | 8,0 | 1 |



Master



- Fabricada en acero inoxidable 18/10 de máxima calidad.
- Marcaje interior, grabado con la capacidad del uso de la olla.
- Visualizador de los niveles de cocción mediante anillos de colores.
- 2 niveles de cocción: 1- Rápida (verduras, hortalizas y pescados). / 2- Superrápida (carnes y estofados).
- Válv. de seguridad · Sist. de bloqueo de seguridad · Ventanas laterales de seguridad.
- Apta para todo tipo de cocinas.
- Fondo FULL INDUCTION.

- Fabrication en acier inoxydable 18/10 de qualité maximale.
- Marquage intérieur, marquage gravé de la capacité d'utilisation de l'autocuiseur. Visualisateur des niveaux de cuisson via anneaux de couleur.
- 2 niveaux de cuisson: 1-Rapide (légumes et les poissons). 2-Super rapide (viandes et les ragoûts).
- Soupape de sécurité · Syst. de blocage de sécurité · Fenêtres latérales de sécurité.
- Apte pour tout type de feux.
- Fond FULL INDUCTION.

- Manufactured in high-quality 18/10 stainless steel.
- Inner marking, engraved with the cooker's capacity.
- Cooking level indicator-display using coloured rings.
- 2 cooking levels: 1-Fast (vegetables and fish). 2- Super-fast (meats and stews).
- Safety valve · Safety locking system · Side safety windows.
- Suitable for any type of hob.
- FULL INDUCTION base.



Niveles de cocción
Cooking levels



Marcaje interior
Inner marking

Olla a presión

Cocotte à pression · Schnellkochtopf
Pressure cooker · Painela de pressão

| Ref | € | Ø (cm) | h(cm) | L | U.Venta |
|-------|--------|--------|-------|-----|---------|
| 71884 | 81,50 | 22 | 15,5 | 4,0 | 1 |
| 71886 | 88,40 | 22 | 22,0 | 6,0 | 1 |
| 71887 | 106,60 | 24 | 23,5 | 8,0 | 1 |

Tempo

INOX
18/10

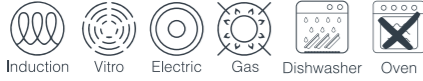

- Fabricada en acero inoxidable 18/10 de máxima calidad.
- Marcaje interior, grabado con la capacidad del uso de la olla.
- Válvula de control para seleccionar el nivel de presión.
- Niveles de cocción: cocción lenta y cocción rápida.
- Válvula de seguridad · Sistema de bloqueo de seguridad
- Ventanas laterales de seguridad.
- Apta para todo tipo de cocinas.
- Triple fondo FULL INDUCTION para una distribución rápida y homogénea del calor.

- Fabrication en acier inoxydable 18/10 de qualité maximale.
- Marquage intérieur, marquage gravé de la capacité d'utilisation de l'autocuiseur.
- Valve de contrôle pour sélectionner le niveau de pression
- Niveaux de cuisson : cuisson lente et cuisson rapide.
- Soupape de sécurité · Syst. de blocage de sécurité
- Fenêtres latérales de sécurité.
- Apte pour tout type de feux.
- INDUCTION TOTALE triple fond pour une distribution rapide et homogène de la chaleur.

- Manufactured in high-quality 18/10 stainless steel.
- Inner marking, engraved with the cooker's capacity.
- Control valve for selecting the power level.
- Cooking levels: slow cooking and fast cooking.
- Safety valve · Safety locking system.
- Side safety windows.
- Suitable for any type of hob.
- Tri-ply FULL INDUCTION base for quick, even heat distribution.



Olla a presión

Cocotte à pression · Schnellkochtopf
Pressure cooker · Panela de pressão

| Ref | € | Ø (cm) | h(cm) | L | U.Venta |
|-------|-------|--------|-------|-----|---------|
| 71864 | 89,60 | 22 | 15,0 | 4,0 | 1 |
| 71866 | 92,10 | 22 | 23,0 | 6,0 | 1 |
| 71868 | 98,90 | 22 | 27,0 | 8,0 | 1 |

Set de ollas a presión

Ensemble de cocottes à pression · Schnellkochtopf-Satz
Set of pressure cooker · Conj. de panelas de pressão

| Ref | € | Ø (cm) | h(cm) | L | U.Venta |
|-------|--------|--------|-------|-----|---------|
| 71862 | 140,50 | 22 | 16,0 | 6,0 | 1 |
| | | 22 | 22,0 | 4,0 | |



Sartenes Fryingpan





Chef Inox Collection



- Fabricadas en acero inoxidable 18/10 de la mejor calidad.
- Máxima garantía en resistencia, durabilidad e higiene.
- Acabado interior y exterior lijado satinado.
- Fondo termodifusor sándwich, distribución rápida y uniforme del calor.
- Homogeneidad y eficacia térmica. Cocción ultrarrápida.
- Apts para todos los fuegos.

- Fabriquées en acier inoxydable 18/10 de la meilleure qualité.
- Garantie maximale de résistance, de durabilité et d'hygiène.
- Finition interne et externe en brossage satiné.
- Fond thermo-diffuseur sandwich, distribution rapide et uniforme de la chaleur.
- Homogénéité et efficacité thermique. Cuisson ultra-rapide.
- Aptes pour tous les feux.

- Made of 18/10 stainless steel of the best quality.
- Maximum guarantee in resistance, durability and hygiene.
- Glossy sanded interior and exterior finish.
- Heat-diffusing sandwiched base, quick and even heat distribution.
- Thermal homogeneity and efficiency. Ultra-rapid cooking.
- Suitable for all types of cookers.



Sartén Chef Classic

Poêle · Pfanne
Frying-pan · Sertä

| Ref | € | Ø (cm) | h(cm) | e (mm) | U.Venta |
|-------|--------|--------|-------|--------|---------|
| 51620 | 42,00 | 20 | 4,0 | 1,0 | 1 |
| 51624 | 46,40 | 24 | 4,5 | 1,0 | 1 |
| 51628 | 56,20 | 28 | 5,5 | 1,0 | 1 |
| 51632 | 67,30 | 32 | 6,0 | 1,0 | 1 |
| 51636 | 84,40 | 36 | 6,5 | 1,0 | 1 |
| 51640 | 101,00 | 40 | 6,5 | 1,0 | 1 |



Sartenes Chef Classic Plus

Poêle · Pfanne
Frying-pan · Sertä

| Ref | € | Ø (cm) | h(cm) | e (mm) | U.Venta |
|-------|--------|--------|-------|--------|---------|
| 51621 | 51,60 | 20 | 4,0 | 1,0 | 1 |
| 51625 | 57,80 | 24 | 4,5 | 1,0 | 1 |
| 51629 | 69,70 | 28 | 5,5 | 1,0 | 1 |
| 51633 | 86,50 | 32 | 6,0 | 1,0 | 1 |
| 51637 | 112,10 | 36 | 6,5 | 1,0 | 1 |
| 51641 | 130,70 | 40 | 6,5 | 1,0 | 1 |



Sartén Chef Classic Ceram

Poêle · Pfanne
Frying-pan · Sertä

| Ref | € | Ø (cm) | h(cm) | e (mm) | U.Venta |
|-------|--------|--------|-------|--------|---------|
| 51720 | 53,30 | 20 | 4,0 | 1,0 | 1 |
| 51724 | 60,50 | 24 | 4,5 | 1,0 | 1 |
| 51728 | 73,00 | 28 | 5,5 | 1,0 | 1 |
| 51732 | 91,20 | 32 | 6,0 | 1,0 | 1 |
| 51736 | 113,00 | 36 | 6,5 | 1,0 | 1 |
| 51740 | 132,40 | 40 | 6,5 | 1,0 | 1 |

Chef Alum Collection



- Sartenes fabricadas en aluminio de máxima calidad diseñadas para uso profesional.
- Recubrimiento antiadherente.
- Ecológico, libre de materiales tóxicos y pesados. Libre de PFOA.
- Apts para todo tipo de cocinas, excepto inducción.

- Poêles fabriquées en aluminium de grande qualité conçues pour un usage professionnel.
- Revêtement antiadhésif.
- Écologique, exempt de matériaux toxiques et lourds. Sans PFOA.
- Compatible tous feux sauf induction, excepté induction.

- Pans made in top quality aluminium and design for professional use.
- Ecological, free of toxic and heavy materials. PFOA free.
- Suitable for all types of cooking surfaces, except induction.



Sartenes Chef Tricapa

Poêle · Pfanne
Frying pan · Sertä

| Ref | € | Ø (cm) | h(cm) | e (mm) | U.Venta |
|-------|-------|--------|-------|--------|---------|
| 21618 | 27,00 | 18 | 3,8 | 2,5 | 6 |
| 21620 | 29,60 | 20 | 4,0 | 3,5 | 6 |
| 21622 | 32,40 | 22 | 4,0 | 3,5 | 6 |
| 21624 | 35,70 | 24 | 4,5 | 3,5 | 6 |
| 21626 | 39,50 | 26 | 4,5 | 4,0 | 6 |
| 21628 | 45,00 | 28 | 4,5 | 4,0 | 6 |
| 21632 | 53,10 | 32 | 4,7 | 4,0 | 6 |
| 21636 | 63,30 | 36 | 5,5 | 4,0 | 4 |
| 21640 | 73,30 | 40 | 5,5 | 4,0 | 4 |



Sartén honda Chef Tricapa

Poêle profonde · Tiefe Pfanne
Deep frying-pan · Sertä funda

| Ref | € | Ø (cm) | h(cm) | e (mm) | U.Venta |
|-------|-------|--------|-------|--------|---------|
| 21524 | 54,60 | 24 | 6,5 | 3,5 | 1 |
| 21528 | 67,60 | 28 | 6,5 | 4,0 | 1 |



Induction



Sartén Tricapa plus

Poêle avec fond · Pfanne mit Boden
Frying-pan with botton · Sertä com fundo

| Ref | € | Ø (cm) | h(cm) | e (mm) | U.Venta |
|---------|-------|--------|-------|--------|---------|
| * 21718 | 29,90 | 18 | 3,8 | 2,5 | 6 |
| * 21720 | 34,00 | 20 | 4,0 | 3,5 | 6 |
| * 21722 | 36,00 | 22 | 4,0 | 3,5 | 6 |
| * 21724 | 39,90 | 24 | 4,5 | 3,5 | 6 |
| * 21726 | 46,40 | 26 | 4,5 | 4,0 | 6 |
| * 21728 | 49,90 | 28 | 4,5 | 4,0 | 6 |
| * 21732 | 57,90 | 32 | 4,7 | 4,0 | 6 |
| 21736 | 70,80 | 36 | 5,5 | 4,0 | 4 |

* Compatible con nuestro mango de silicona (Ref.: 23900)
Compatible with our silicone handle (Ref.: 23900)

Acabado cerámico
Ceramic finished



Induction



Sartén Eco Chef

Poêle avec fond · Pfanne mit Boden
Frying-pan with botton · Sertä com fundo

| Ref | € | Ø (cm) | h(cm) | e (mm) | U.Venta |
|-------|-------|--------|-------|--------|---------|
| 22718 | 32,20 | 18 | 3,8 | 2,5 | 6 |
| 22720 | 36,50 | 20 | 4,0 | 3,5 | 6 |
| 22722 | 39,90 | 22 | 4,0 | 3,5 | 6 |
| 22724 | 42,50 | 24 | 4,5 | 3,5 | 6 |
| 22726 | 49,30 | 26 | 4,5 | 4,0 | 6 |
| 22728 | 53,70 | 28 | 4,5 | 4,0 | 6 |
| 22732 | 63,00 | 32 | 4,7 | 4,0 | 6 |
| 22736 | 74,20 | 36 | 5,5 | 4,0 | 4 |

Sartén Dynamic

Poêle · Pfanne
Frying-pan · Sertä

| Ref | € | Ø (cm) | h(cm) | e (mm) | U.Venta |
|---------|-------|--------|-------|--------|---------|
| 23416 | 15,20 | 16 | 3,5 | 2,5 | 6 |
| 23418 | 16,40 | 18 | 3,5 | 2,5 | 6 |
| * 23420 | 19,50 | 20 | 4,0 | 3,5 | 6 |
| * 23422 | 22,90 | 22 | 4,0 | 3,5 | 6 |
| * 23424 | 25,40 | 24 | 4,5 | 3,5 | 6 |
| * 23426 | 30,30 | 26 | 4,5 | 4,0 | 6 |
| * 23428 | 32,80 | 28 | 4,5 | 4,0 | 6 |
| * 23432 | 39,50 | 32 | 4,7 | 4,0 | 6 |
| 23436 | 51,00 | 36 | 5,5 | 4,0 | 4 |

* Compatible con nuestro mango de silicona (Ref.: 23900)
Compatible with our silicone handle (Ref.: 23900)

Sartenes Garinox

garinox[®]
sartenes profesionales

new

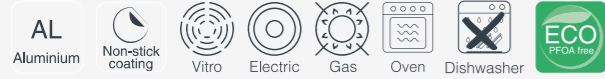

Aine

- Fabricadas en aluminio de máxima calidad.
- Mango ergonómico de acero inoxidable.
- Máxima garantía en resistencia, durabilidad e higiene.
- Antiadherente ILAG ULTIMATE (Swiss Technology).
- Libre de materiales tóxicos y pesados, disolventes y sustancias químicas. 100% libre de PFOA.

- Made of top quality aluminium.
- Ergonomic stainless steel handle.
- Maximum guarantee in resistance, durability and hygiene.
- ILAG ULTIMATE non-stick coating (Swiss Technology).
- Free of toxic and heavy materials, solvents and chemicals. 100% PFOA-free.



Sartén Aine

Poêle · Pflanne
Frying-pan · Sertä

| Ref | € | Ø (cm) | Ød (cm) | h(cm) | e (mm) | U.Venta |
|-------|-------|--------|---------|-------|--------|---------|
| 14518 | 13,20 | 18 | 13,0 | 4,5 | 2,5 | 1 |
| 14520 | 14,80 | 20 | 13,5 | 4,5 | 3,5 | 1 |
| 14522 | 16,50 | 22 | 14,5 | 4,5 | 3,5 | 1 |
| 14524 | 18,20 | 24 | 17,0 | 5,0 | 3,5 | 1 |
| 14526 | 19,50 | 26 | 18,0 | 5,0 | 3,5 | 1 |
| 14528 | 22,30 | 28 | 20,0 | 5,0 | 3,5 | 1 |
| 14532 | 27,30 | 32 | 21,0 | 5,7 | 3,5 | 1 |
| 14536 | 34,30 | 36 | 24,0 | 5,8 | 3,5 | 1 |
| 14540 | 40,40 | 40 | 27,0 | 6,4 | 3,5 | 1 |



Kai

- Fabricadas en aluminio de máxima calidad.
- Mango de hierro forjado.
- Máxima garantía en resistencia, durabilidad e higiene.
- Antiadherente ILAG ULTIMATE (Swiss Technology).
- Libre de materiales tóxicos y pesados, disolventes y sustancias químicas. 100% libre de PFOA

- Made of top quality aluminium.
- Wrought iron handle.
- Maximum guarantee in resistance, durability and hygiene.
- ILAG ULTIMATE non-stick coating (Swiss Technology).
- Free of toxic and heavy materials, solvents and chemicals. 100% PFOA-free.



Sartén Kai

Poêle · Pflanne
Frying-pan · Sertä

| Ref | € | Ø (cm) | Ød (cm) | h(cm) | e (mm) | U.Venta |
|-------|-------|--------|---------|-------|--------|---------|
| 14718 | 11,10 | 18 | 13,0 | 4,5 | 2,5 | 1 |
| 14720 | 14,20 | 20 | 13,5 | 4,5 | 3,5 | 1 |
| 14722 | 15,70 | 22 | 14,5 | 4,5 | 3,5 | 1 |
| 14724 | 17,40 | 24 | 17,0 | 5,0 | 3,5 | 1 |
| 14726 | 19,10 | 26 | 18,0 | 5,0 | 3,5 | 1 |
| 14728 | 21,40 | 28 | 20,0 | 5,0 | 3,5 | 1 |
| 14732 | 26,40 | 32 | 21,0 | 5,7 | 3,5 | 1 |
| 14736 | 33,20 | 36 | 24,0 | 5,8 | 3,5 | 1 |
| 14740 | 39,30 | 40 | 27,0 | 6,4 | 3,5 | 1 |



Vukan

- Fabricadas en aluminio de máxima calidad.
- Mango ergonómico de acero inoxidable.
- Máxima garantía en resistencia, durabilidad e higiene.
- Nuevo antiadherente cerámico Fusion Pro de PPG™.
- Libre de materiales tóxicos y pesados, disolventes y sustancias químicas. 100% PFASfree.

- Made of top quality aluminium.
- Ergonomic stainless steel handle.
- Maximum guarantee of strength, durability and hygiene.
- New PPG™ Fusion Pro ceramic non-stick coating.
- Free of toxic and heavy materials, solvents and chemicals. 100% PFASfree.



- 1 Special sol-gel topcoat engineered to provide improved release
- 2 Special reinforced sol-gel primer
- 3 Aluminium substrate

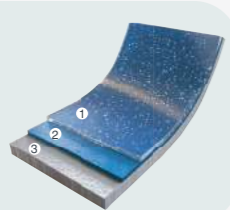

Sartén Vukan

Poêle · Pflanne
Frying-pan · Sertä

| Ref | € | Ø (cm) | Ød (cm) | h(cm) | e (mm) | U.Venta |
|-------|-------|--------|---------|-------|--------|---------|
| 14818 | 13,20 | 18 | 13,0 | 4,5 | 2,5 | 1 |
| 14820 | 14,80 | 20 | 13,5 | 4,5 | 3,5 | 1 |
| 14822 | 16,50 | 22 | 14,5 | 4,5 | 3,5 | 1 |
| 14824 | 18,20 | 24 | 17,0 | 5,0 | 3,5 | 1 |
| 14826 | 19,50 | 26 | 18,0 | 5,0 | 3,5 | 1 |
| 14828 | 22,30 | 28 | 20,0 | 5,0 | 3,5 | 1 |
| 14832 | 27,30 | 32 | 21,0 | 5,7 | 3,5 | 1 |
| 14836 | 34,30 | 36 | 24,0 | 5,8 | 3,5 | 1 |
| 14840 | 40,40 | 40 | 27,0 | 6,4 | 3,5 | 1 |



Adara / Kenna

- Fabricada en aluminio de máxima calidad.
- Fondo termodifusor sandwich, distribución rápida y uniforme del calor.
- Antiadherente ILAG ULTIMATE (Swiss Technology) 100% libre de PFOA.
- Libre de materiales tóxicos, pesados, disolventes y sustancias químicas.
- Apta para todos los fuegos.

- Made of top quality aluminium.
- Heat-diffusing sandwiched base, quick and even heat distribution.
- ILAG ULTIMATE (Swiss Technology) non-stick coating, 100% PFOA free.
- It's free of toxic materials, heavy metals, solvents and chemical substances.
- Suitable for all types of cookers.



Sartén ADARA

Poêle · Pflanne
Frying-pan · Sertä

| Ref | € | Ø (cm) | Ød (cm) | h(cm) | e (mm) | U.Venta |
|-------|-------|--------|---------|-------|--------|---------|
| 14590 | 17,30 | 20 | 13,0 | 4,5 | 3,5 | 1 |
| 14594 | 21,20 | 24 | 16,5 | 5,0 | 3,5 | 1 |
| 14598 | 25,70 | 28 | 19,0 | 5,0 | 3,5 | 1 |
| 14592 | 31,30 | 32 | 20,5 | 5,5 | 3,5 | 1 |



Sartén KENNA

Poêle · Pflanne
Frying-pan · Sertä

| Ref | € | Ø (cm) | Ød (cm) | h(cm) | e (mm) | U.Venta |
|-------|-------|--------|---------|-------|--------|---------|
| 14790 | 16,60 | 20 | 13,0 | 4,5 | 3,5 | 1 |
| 14794 | 20,40 | 24 | 16,5 | 5,0 | 3,5 | 1 |
| 14798 | 25,00 | 28 | 19,0 | 5,0 | 3,5 | 1 |
| 14792 | 30,30 | 32 | 20,5 | 5,5 | 3,5 | 1 |



new



Robust Collection



- Sartenes fabricadas en aluminio de máxima calidad diseñadas para uso profesional.
- Óptima distribución de calor conservando las propiedades nutritivas de los alimentos y con un mínimo gasto de aceite y energía.
- Recubrimiento antiadherente multicapa (5 capas) ecológico y libre de PFOA.
- Ideales para un uso continuo. Ligeras, manejables y fáciles de limpiar gracias a su antiadherente exterior.
- Aptas para todo tipo de cocinas, excepto inducción.

- Poêles fabriquées en aluminium de grande qualité conçues pour un usage professionnel.
- Distribution optimale de la chaleur en conservant les propriétés nutritives des aliments et avec une utilisation d'huile et d'énergie minimales.
- Revêtement antiadhésif multicouche (5 couches) écologique et sans PFOA.
- Idéales pour un usage continu. Légères, maniables et faciles à nettoyer grâce à leur revêtement antiadhésif extérieur.
- Compatibles avec tout type de cuisinière, excepté l'induction.

- Pans made in top quality aluminium and design for professional use.
- Optimal heat distribution, preserving the nutritional properties and with a minimal waste of oil and energy.
- Multi-layer (5 layers) eco-friendly non-stick coating, PFOA-free.
- Ideal for continuous use. Light, easy handling and easy to clean due to its nonstick exterior.
- Suitable for all types of cooking surfaces, except induction.

Sartén

Poêle · Pflanne
Frying-pan · Sertä

| Ref | € | Ø (cm) | h(cm) | e (mm) | U.Venta |
|---------|-------|--------|-------|--------|---------|
| 23616 | 15,20 | 16 | 3,5 | 2,5 | 6 |
| 23618 | 16,40 | 18 | 3,5 | 2,5 | 6 |
| * 23620 | 19,50 | 20 | 4,0 | 3,5 | 6 |
| * 23622 | 22,90 | 22 | 4,0 | 3,5 | 6 |
| * 23624 | 25,10 | 24 | 4,5 | 3,5 | 6 |
| * 23626 | 30,30 | 26 | 4,5 | 4,0 | 6 |
| * 23628 | 32,50 | 28 | 4,5 | 4,0 | 6 |
| * 23632 | 39,10 | 32 | 4,7 | 4,0 | 6 |
| 23636 | 51,00 | 36 | 5,5 | 4,0 | 4 |
| 23640 | 59,80 | 40 | 5,5 | 4,0 | 4 |

* Compatible con nuestro mango de silicona (Ref.: 23900)
Compatible with our silicone handle (Ref.: 23900)

Sartén Robust Plus

Poêle · Pflanne
Frying-pan · Sertä

| Ref | € | Ø (cm) | h(cm) | e (mm) | U.Venta |
|-------|-------|--------|-------|--------|---------|
| 23816 | 17,00 | 16 | 3,5 | 2,5 | 6 |
| 23818 | 18,20 | 18 | 3,5 | 2,5 | 6 |
| 23820 | 22,00 | 20 | 4,0 | 3,5 | 6 |
| 23822 | 24,80 | 22 | 4,0 | 3,5 | 6 |
| 23824 | 27,50 | 24 | 4,5 | 3,5 | 6 |
| 23826 | 31,90 | 26 | 4,5 | 4,0 | 6 |
| 23828 | 37,10 | 28 | 4,5 | 4,0 | 6 |
| 23832 | 43,00 | 32 | 4,7 | 4,0 | 6 |
| 23836 | 52,80 | 36 | 5,5 | 4,0 | 4 |
| 23840 | 63,80 | 40 | 5,5 | 4,0 | 4 |

Sartén Honda

Poêle profonde · Tiefe Pflanne
Deep frying-pan · Sertä funda

| Ref | € | Ø (cm) | Ød (cm) | h(cm) | e (mm) | U.Venta |
|---------|-------|--------|---------|-------|--------|---------|
| * 23625 | 42,90 | 24 | 18,5 | 6,5 | 3,5 | 1 |
| * 23629 | 48,80 | 28 | 22,0 | 6,5 | 4,0 | 1 |

* Compatible con nuestro mango de silicona (Ref.: 23900)
Compatible with our silicone handle (Ref.: 23900)

Sartén blinis

Poêle Blinis · Pflanne Blinis
Frying-pan Blinis · Sertä Blinis

| Ref | € | Ø (cm) | h(cm) | e (mm) | U.Venta |
|-------|-------|--------|-------|--------|---------|
| 23612 | 11,70 | 12 | 2,1 | 2,5 | 6 |
| 23614 | 13,80 | 14 | 2,2 | 2,5 | 6 |

Wok

Wok · Wok
Wok · Wok

| Ref | € | Ø (cm) | h(cm) | e (mm) | U.Venta |
|---------|-------|--------|-------|--------|---------|
| * 23830 | 45,00 | 30 | 7,0 | 4,0 | 1 |

* Compatible con nuestro mango de silicona (Ref.: 23900)
Compatible with our silicone handle (Ref.: 23900)

Crepera

Crêpiere · Crêpes Pflanne
Crepiere · Crepeira

| Ref | € | Ø (cm) | h(cm) | e (mm) | U.Venta |
|---------|-------|--------|-------|--------|---------|
| * 23322 | 18,50 | 22 | 1,8 | 2,5 | 1 |
| * 23326 | 23,30 | 26 | 1,8 | 2,7 | 1 |
| * 23330 | 33,70 | 30 | 2,2 | 4,0 | 1 |

* Compatible con nuestro mango de silicona (Ref.: 23900)
Compatible with our silicone handle (Ref.: 23900)

Sartén Oval

Poêle ova · Pflanne, oval
Oval frying-pan · Sertä oval

| Ref | € | cm | h(cm) | e (mm) | U.Venta |
|-------|-------|-------|-------|--------|---------|
| 23637 | 65,40 | 36x26 | 5,0 | 2,7 | 1 |
| 23641 | 68,10 | 40x29 | 5,5 | 2,7 | 1 |

Sartén rectangular

Poêle rectangulière · Pflanne, rechteckig
Rectangular frying-pan · Sertä rectangular

| Ref | € | cm | h(cm) | e (mm) | U.Venta |
|---------|-------|-------|-------|--------|---------|
| * 23638 | 57,20 | 38x26 | 5,0 | 4,0 | 1 |

* Compatible con nuestro mango de silicona (Ref.: 23900)
Compatible with our silicone handle (Ref.: 23900)

Paellera

Plat rond · Paellapflanne
Round dish · Paelheira

| Ref | € | Ø (cm) | h(cm) | U.Venta |
|-------|-------|--------|-------|---------|
| 23724 | 23,40 | 24 | 4,00 | 1 |
| 23728 | 30,70 | 28 | 4,50 | 1 |
| 23732 | 36,20 | 32 | 5,00 | 1 |
| 23736 | 43,70 | 36 | 5,50 | 1 |
| 23740 | 54,00 | 40 | 6,00 | 1 |



Wok Basic & Rustic



- Ideal para preparar salteados, quedando crujientes y conservando sus nutrientes.
- Duraderos y resistentes a arañazos.
- Alta conductividad térmica. El hierro al ser un excelente conductor del calor, permite conseguir y mantener la temperatura ideal de cocción con un menor consumo energético.
- Ligero y manejable.
- Mango ergonómico.
- Antiadherente tri-capa, libre de materiales tóxicos y pesados, ecológico y libre de PFOA.
- Fácil limpieza.
- Apta para todo tipo de cocinas, incluida la inducción.

- Idéal pour les sautés, les aliments restent croustillant et conservent leurs nutriments.
- Durable et résistant aux rayures.
- Haute conductivité thermique. Le métal, excellent conducteur de chaleur, permet d'obtenir et de maintenir la température de cuisson idéale avec une consommation d'énergie moins importante.
- Léger et maniable.
- Poignée ergonomique.
- Antiadhésif à trois couches, sans matériaux toxiques ni métaux lourds, écologique et sans PFOA.
- Nettoyage facile.
- Compatible avec tout type de cuisinières.

- Ideal for making stir-fries, keeping ingredients crisp and preserving their nutrients.
- Durable and scratch-resistant.
- High thermal conductivity. Being an excellent heat conductor, iron allows the ideal cooking temperature to be quickly reached and maintained using less energy consumption.
- Lightweight and practical.
- Ergonomic handle.
- Three-layer non-stick coating, free from toxic and heavy materials, environmentally friendly and PFOA-free.
- Easy to clean.
- Suitable for all types of cooking surfaces.

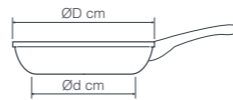

Wok antiadherente Basic

Wok, Antiadherent · Wok, Antihaft
Wok, Non-stick · Wok anti-aderente

| Ref | € | Ø (cm) | Ød (cm) | h(cm) | e (mm) | U.Venta |
|-------|-------|--------|---------|-------|--------|---------|
| 63729 | 36,80 | 28 | 15 | 8,5 | 0,9 | 1 |
| 63733 | 37,40 | 32 | 15 | 9,5 | 0,9 | 1 |



Wok antiadherente Rustic

Wok, Antiadherent · Wok, Antihaft
Wok, Non-stick · Wok anti-aderente

| Ref | € | Ø (cm) | Ød (cm) | h(cm) | e (mm) | U.Venta |
|-------|-------|--------|---------|-------|--------|---------|
| 66128 | 36,80 | 28 | 15 | 8,5 | 0,9 | 1 |
| 66132 | 37,40 | 32 | 15 | 9,5 | 0,9 | 1 |



Ferrum Collection

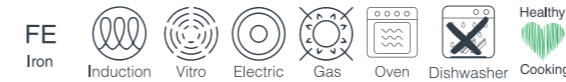

- Disfruta de una sartén para toda la vida.
- Fabricadas artesanalmente con 100% hierro natural.
- Calidad Premium; duraderas y resistentes a arañazos.
- Alta conductividad térmica. El hierro al ser un excelente conductor del calor, permite conseguir y mantener la temperatura ideal de cocción con un menor consumo energético.
- Espesor 2,5 mm. Fácil limpieza. Cocina ecológica, cocina saludable.
- Antiadherente premium, libre de PFOA (sartén antiadherente).

- Une poêle qui vous durera toute la vie.
- Fabriquées de façon artisanale avec 100% de métal naturel.
- Qualité Premium; durables et résistantes aux rayures.
- Haute conductivité thermique. Le métal, excellent conducteur de chaleur, permet d'obtenir et de maintenir la température de cuisson idéale avec une consommation d'énergie moins importante.
- Épaisseur 2,5mm. Nettoyage facile. Cuisine écologique, cuisine saine.
- Antiadhésif premium, sans PFOA (Poêle antiadherent).

- Enjoy this one pan your whole life.
- Hand-made in 100% natural iron.
- Premium Quality; long lasting and resistant to scratching.
- High heat conduction. Iron is an excellent conductor of heat, allowing you to obtain and maintain the ideal temperature with less energy consumption
- 2.5mm thickness. Easy to clean. Eco-friendly, healthy kitchen.
- Premium Quality; long lasting and resistant to scratching (Non-stick frying-pan).

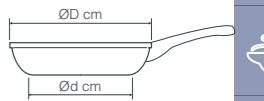

Sartén

Poêle · Pflanne
Frying-pan · Sertã

| Ref | € | Ø (cm) | h(cm) | e (mm) | U.Venta |
|---------|-------|--------|-------|--------|---------|
| * 63620 | 30,80 | 20 | 3,5 | 2,5 | 1 |
| * 63624 | 35,50 | 24 | 4,5 | 2,5 | 1 |
| * 63626 | 38,30 | 26 | 4,5 | 2,5 | 1 |
| * 63628 | 40,40 | 28 | 5,0 | 2,5 | 1 |
| * 63632 | 48,40 | 32 | 5,3 | 2,5 | 1 |
| 63636 | 61,60 | 36 | 5,5 | 2,5 | 1 |
| 63640 | 68,30 | 40 | 5,8 | 2,5 | 1 |

* Compatible con nuestro mango de silicona (Ref.: 23900)
Compatible with our silicone handle (Ref.: 23900)



Sartén antiadherente

Poêle antiadherent · Pflanne, Antihaft
Frying-pan, non-stick · Sertã anti-aderente

| Ref | € | Ø (cm) | h(cm) | e (mm) | U.Venta |
|---------|-------|--------|-------|--------|---------|
| * 63720 | 34,80 | 20 | 3,5 | 2,5 | 1 |
| * 63724 | 38,30 | 24 | 4,5 | 2,5 | 1 |
| * 63726 | 41,00 | 26 | 4,5 | 2,5 | 1 |
| * 63728 | 43,40 | 28 | 5,0 | 2,5 | 1 |
| * 63732 | 51,00 | 32 | 5,3 | 2,5 | 1 |
| 63736 | 64,40 | 36 | 5,5 | 2,5 | 1 |
| 63740 | 74,50 | 40 | 5,8 | 2,5 | 1 |

* Compatible con nuestro mango de silicona (Ref.: 23900)
Compatible with our silicone handle (Ref.: 23900)



Sartén honda

Poêle profonde · Tiefe Pfanne
Deep frying-pan · Sertã funda

| Ref | € | Ø (cm) | h(cm) | e (mm) | U.Venta |
|---------|-------|--------|-------|--------|---------|
| * 63424 | 51,60 | 24 | 7,0 | 2,5 | 1 |
| * 63428 | 59,70 | 28 | 8,0 | 2,5 | 1 |
| * 63432 | 88,10 | 32 | 8,8 | 2,5 | 1 |

* Compatible con nuestro mango de silicona (Ref.: 23900)
Compatible with our silicone handle (Ref.: 23900)



Sartén blinis

Poêle Blinis · Blinis Pfanne
Blinis frying pan · Sertã Blinis

| Ref | € | Ø (cm) | h(cm) | e (mm) | U.Venta |
|-------|-------|--------|-------|--------|---------|
| 63613 | 25,70 | 12 | 2,1 | 2,0 | 6 |
| 63614 | 28,80 | 14 | 2,2 | 2,0 | 6 |



Asador

Rôtissoire · Grill
Rotisserie · Grelhador

| Ref | € | Ø (cm) | h(cm) | e (mm) | U.Venta |
|---------|-------|--------|-------|--------|---------|
| * 63725 | 38,30 | 26 | 3,0 | 2,5 | 1 |

* Compatible con nuestro mango de silicona (Ref.: 23900)
Compatible with our silicone handle (Ref.: 23900)

Asas de acero inoxidable
Stainless steel handles



Paellera

Plat à paella · Paellapfanne
Round dish for paella · Paelheira

| Ref | € | Ø (cm) | h(cm) | e (mm) | Raciones | U.Venta |
|-------|-------|--------|-------|--------|----------|---------|
| 63928 | 58,70 | 28 | 4,5 | 2,5 | 3 | 1 |
| 63932 | 66,50 | 32 | 4,7 | 2,5 | 5 | 1 |
| 63936 | 82,90 | 36 | 5,5 | 2,5 | 7 | 1 |
| 63940 | 91,30 | 40 | 5,5 | 2,5 | 9 | 1 |



Cazo bombado

Casserole bombée · Kasserolle, Bauchig
Rounded saucepan · Caçarola bojuda

| Ref | € | Ø (cm) | h(cm) | e (mm) | U.Venta |
|---------|-------|--------|-------|--------|---------|
| * 63419 | 47,50 | 20 | 10 | 2,5 | 1 |
| * 63423 | 59,70 | 24 | 12 | 2,5 | 1 |

* Compatible con nuestro mango de silicona (Ref.: 23900)
Compatible with our silicone handle (Ref.: 23900)



Sartén blinis con antiadherente

Poêle Blinis antiadherent · Blinis Pfanne, Antihaft
Blinis frying pan, Non-stick · Sertã Blinis anti-aderente

| Ref | € | Ø (cm) | h(cm) | e (mm) | U.Venta |
|-------|-------|--------|-------|--------|---------|
| 63712 | 27,10 | 12 | 2,1 | 2,0 | 6 |
| 63714 | 29,90 | 14 | 2,2 | 2,0 | 6 |



Asador antiadherente

Rôtissoire, antiadherent · Grill, Antihaft
Non-stick rotisserie · Grelhador anti-aderente

| Ref | € | Ø (cm) | h(cm) | e (mm) | U.Venta |
|---------|-------|--------|-------|--------|---------|
| * 63727 | 39,50 | 26 | 3,0 | 2,5 | 1 |

* Compatible con nuestro mango de silicona (Ref.: 23900)
Compatible with our silicone handle (Ref.: 23900)

Asas de acero inoxidable
Stainless steel handles



Plancha grill

Plaque à Grill · Platte Grill
Grill plaque · Plancha Grill

| Ref | € | cm | h(cm) | e (mm) | U.Venta |
|-------|-------|-------|-------|--------|---------|
| 63644 | 75,50 | 37x27 | 5,0 | 2,5 | 1 |

Wok

Wok · Wok
Wok · Wok



| Ref | € | Ø (cm) | Ød (cm) | h(cm) | e (mm) | U.Venta |
|---------|-------|--------|---------|-------|--------|---------|
| * 63828 | 49,70 | 28 | 15,0 | 8,0 | 2,0 | 1 |
| * 63232 | 56,20 | 32 | 15,0 | 9,5 | 2,0 | 1 |

* Compatible con nuestro mango de silicona (Ref.: 23900)
Compatible with our silicone handle (Ref.: 23900)

Asas de acero inoxidable
Stainless steel handles



Plancha grill lisa

Plaque à Grill lisse · Platte Grill, glatt
Grill flat plaque · Plancha Grill lisa

| Ref | € | cm | h(cm) | e (mm) | U.Venta |
|-------|-------|-------|-------|--------|---------|
| 63642 | 71,10 | 37x27 | 5,0 | 2,5 | 1 |



Wok antiadherente

Wok, Antiadherent · Wok, Antihalt
Wok, non-stick · Wok anti-aderente

| Ref | € | Ø (cm) | Ød (cm) | h(cm) | e (mm) | U.Venta |
|---------|-------|--------|---------|-------|--------|---------|
| * 63829 | 51,80 | 28 | 15,0 | 8,0 | 2,0 | 1 |
| * 63233 | 59,10 | 32 | 15,0 | 9,5 | 2,0 | 1 |

* Compatible con nuestro mango de silicona (Ref.: 23900)
Compatible with our silicone handle (Ref.: 23900)

new



Crepera

Crepière · Crêpes-Pfanne
Crepiera · Crepeira

| Ref | € | Ø (cm) | Ød (cm) | h(cm) | e (mm) | U.Venta |
|---------|-------|--------|---------|-------|--------|---------|
| * 63322 | 26,60 | 22 | 20 | 1,8 | 2,5 | 1 |
| * 63326 | 31,60 | 26 | 24 | 2,2 | 2,5 | 1 |

* Compatible con nuestro mango de silicona (Ref.: 23900)
Compatible with our silicone handle (Ref.: 23900)



Crepera antiadherente

Crepière, antiadherent · Crêpes-Pfanne, Antihaft
Crepiera, Non-stick · Crepeira anti-aderente

| Ref | € | Ø (cm) | h(cm) | e (mm) | U.Venta |
|---------|-------|--------|-------|--------|---------|
| * 23323 | 27,90 | 22 | 1,8 | 2,5 | 1 |
| * 23327 | 31,90 | 26 | 2,2 | 2,5 | 1 |

* Compatible con nuestro mango de silicona (Ref.: 23900)
Compatible with our silicone handle (Ref.: 23900)

SI
Silicone



Protector de silicona

Protection en silicone · Silikonschutz
Silicone handle cover · Protector de silicone

| Ref | € | Largo (cm) | U.Venta |
|-------|------|------------|---------|
| 23900 | 6,60 | 13,5 | 1 |

- Mango protector de silicona de alta calidad para sartenes.
- Fácil de colocar, se ajusta perfectamente al mango de la sartén.
- Antideslizante y termorresistente, protege de las temperaturas elevadas.
- Compatible con nuestras sartenes Robust, Ferrum, Dynamic y Tricapa Plus (Ø16-32).

- High quality silicone protector mango for pans.
- Easy to place, it fits perfectly to the mango of the pan.
- Non -slip and thermor resistant, protects from high temperatures.
- Compatible with our Robust, Ferrum, Dynamic and Tricapa Plus (Ø16-32).

CRISTAL
Glass



Tapa de cristal

Couvercle en verre avec sortie de vapeur · Glasdeckel mit Dampfloch
Glass Lid with steam hole · Tapa de vidrio con desvaporizador

| Ref | € | Ø (cm) | U.Venta |
|-------|-------|--------|---------|
| 71914 | 11,00 | 14 | 1 |
| 71916 | 11,30 | 16 | 1 |
| 71918 | 11,60 | 18 | 1 |
| 71920 | 12,50 | 20 | 1 |
| 71922 | 12,60 | 22 | 1 |
| 71924 | 13,20 | 24 | 1 |
| 71926 | 14,50 | 26 | 1 |
| 71928 | 15,10 | 28 | 1 |
| 71932 | 17,00 | 32 | 1 |

- Se adapta a todo tipo de baterías de cocina.
- Vidrio térmico resistente a altas temperaturas.
- Borde de acero inoxidable 18/10.

- Il s'adapte à tous les types de batteries de cuisine.
- Verre thermique résistante à haute température.
- 18/10 bord en acier inoxydable.

- It adapts to all types of kitchen batteries.
- High temperature resistant thermal glass.
- 18/10 stainless steel edge.

Sartén Kale



- Fabricada en aluminio fundido. Robusta y duradera.
- Mango termo aislante, altamente resistente y ergonómico, permite un agarre seguro.
- Antiadherente de máxima calidad libre de materiales tóxicos y pesados, disolventes y sustancias químicas. 100 % libre de PFAS (libre de PFOA y PTFE)
- Distribución rápida y uniforme del calor gracias a su fondo FULL INDUCTION

- Fabriqué en fonte d'aluminium. Robuste et durable.
- Poignée très résistante, thermo-isolée et ergonomique conçue de manière ergonomique pour une bonne prise en main.
- Revêtement antiadhésif de la plus haute qualité, exempt de matériaux toxiques et lourds, de solvants et de produits chimiques. 100 % sans PFAS (sans PFOA ni PTFE).
- Distribution rapide et uniforme de la chaleur grâce au fond à FULL INDUCTION.

- Manufactured in cast aluminium. Strong and robust.
- Heat insulating, highly resistant and ergonomic handle, allows a secure grip.
- Top quality non stick coating free of toxic materials and heavy metals, solvents and chemical substances. 100% PFAS free (PFOA y PTFE free).
- Fast and uniform heat distribution thanks to its FULL INDUCTION base.



PFAS free



Sartén Kale

Poêle · Pflanne
Frying-pan · Sertä

| Ref | € | Ø (cm) | Ød (cm) | h(cm) | U.Venta |
|-------|-------|--------|---------|-------|---------|
| 26520 | 21,90 | 20 | 12,0 | 5,0 | 1 |
| 26522 | 23,50 | 22 | 14,5 | 5,5 | 1 |
| 26524 | 25,80 | 24 | 16,0 | 5,5 | 1 |
| 26526 | 28,50 | 26 | 17,0 | 5,5 | 1 |
| 26528 | 31,40 | 28 | 19,0 | 6,0 | 1 |

new

Titanium PRO Collection



Sartén

Poêle · Pflanne
Frying-pan · Sertä

| Ref | € | Ø (cm) | Ød (cm) | h(cm) | e (mm) | U.Venta |
|-------|-------|--------|---------|-------|--------|---------|
| 27820 | 31,50 | 20 | 16,6 | 5,0 | 1,9 | 6 |
| 27824 | 38,80 | 24 | 20,2 | 5,5 | 1,9 | 4 |
| 27828 | 47,10 | 28 | 23,4 | 6,0 | 1,9 | 6 |



Antiadherente Quantanium® reforzado con partículas de titanio; libre de materiales tóxicos y pesados, ecológico y libre de PFOA
Antiadhésif Quantanium® renforcé avec des particules de titane sans matériaux toxiques ni métaux lourds, écologique et sans PFOA.
Quantanium® non-stick reinforced with titanium particles; free from toxic and heavy materials, environmentally friendly and PFOA-free.



Grill

Grill · Grill Induktionfähig
Grill · Grelhador

| Ref | € | cm | h(cm) | e (mm) | U.Venta |
|-------|-------|-------|-------|--------|---------|
| 27827 | 54,90 | 28x28 | 4,0 | 1,8 | 1 |

4 in 1



Sartén 4 cavidades

Poêle 4 cavités · Pflanne, 4-fache Einteilung
Frying-pan 4 cavities · Sertä 4 cavidades

| Ref | € | cm | h(cm) | e (mm) | U.Venta |
|-------|-------|-------|-------|--------|---------|
| 27832 | 47,50 | 32x26 | 3,5 | 1,9 | 1 |

Stilo Collection



Sartén

Poêle · Pflanne
Frying pan · Sertä

| Ref | € | Ø (cm) | Ød (cm) | h(cm) | U.Venta |
|-------|-------|--------|---------|-------|---------|
| 27620 | 35,50 | 20 | 16,5 | 4,5 | 6 |
| 27624 | 40,60 | 24 | 20,0 | 5,2 | 6 |
| 27626 | 44,80 | 26 | 21,5 | 5,5 | 6 |
| 27628 | 48,40 | 28 | 24,0 | 6,0 | 6 |



Grill

Grill · Grill Induktionfähig
Grill · Grelhador

| Ref | € | cm | Ød (cm) | h(cm) | U.Venta |
|-------|-------|-------|---------|-------|---------|
| 27625 | 44,80 | 24x24 | 18,6 | 4,8 | 1 |
| 27629 | 51,90 | 28x28 | 21,5 | 5,2 | 1 |



Eco piedra Collection



- Fabricadas en aluminio fundido de gran calidad y espesor, están reforzadas con partículas a base de piedra y una máxima resistencia al rayado, duración y desgaste.
- La base de aluminio permite una distribución homogénea del calor, permitiendo que los alimentos se cocinen rápidamente y de manera uniforme, sin apenas utilizar aceite.
- Su antiadherente TRlcapa de máxima calidad y ecológico, es libre de PFOA.
- Fácil limpieza interior y exterior gracias al antiadherente.
- Fondo FULL INDUCTION compatible con todas las fuentes de calor, incluida la inducción.
- Excelente conductividad térmica.
- Se puede lavar en el lavavajillas.
- Paelleras · Planchas: asas fabricadas en silicona de máxima calidad, termo aislantes, altamente resistentes y ergonómicas, permiten un agarre seguro de la pieza.

- Fabriquées en fonte d'aluminium de grande qualité et épaisseur, elles sont renforcées par particules à base de pierre et confère une résistance maximale aux rayures et à l'usure pour allonger la durée de vie.
- La base en aluminium permet une distribution homogène de la chaleur, permettant aux aliments de se cuire rapidement et de façon uniforme, sans à peine utiliser d'huile Leur antiadhésif.
- Tri-couche d'une qualité maximale et écologique, est sans PFOA.
- Intérieur et extérieur faciles à nettoyer grâce à la protection antiadhésive.
- Fond « FULL INDUCTION » compatible avec toutes les sources de chaleur, y compris l'induction. Excellente conductivité thermique.
- Peuvent être lavées au lave-vaisselle.
- Plat à paella · Planches : poignées fabriquées en silicone de la plus grande qualité, thermo-isolantes, hautement résistantes et ergonomiques, qui permettent de tenir l'ustensile en toute sécurité.

- Made in high quality and thickness cast aluminium, it is reinforced with stone-based particles and maximum scratch and wear resistance and durability.
- The aluminium base allows for a homogeneous heat distribution, allowing the food to cook quickly and uniformly, without barely any oil.
- Its high quality and eco-friendly non-stick coating TRlcapa is PFOA-free.
- Easy to clean interior and exterior with its non-stick protection.
- FULL INDUCTION base that can be used with all kinds of heat sources, including induction cookers. Excellent thermal conductivity.
- Dishwasher safe.
- Round dish · Grill plaque: heat insulating, highly resistant, ergonomic handles made of high quality silicone which provide a secure grip on pots and pans.

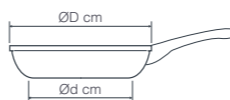

Sartén

Poêle · Pfanne
Frying pan · Sertä



| Ref | € | Ø (cm) | Ød (cm) | h(cm) | e (mm) | U.Venta |
|-------|-------|--------|---------|-------|--------|---------|
| 24118 | 27,90 | 18 | 14,0 | 5,0 | 4,0 | 6 |
| 24120 | 31,70 | 20 | 14,5 | 5,0 | 4,0 | 6 |
| 24122 | 33,80 | 22 | 15,6 | 5,5 | 4,0 | 6 |
| 24124 | 36,70 | 24 | 17,4 | 6,0 | 4,0 | 6 |
| 24126 | 40,90 | 26 | 18,4 | 6,0 | 4,0 | 6 |
| 24128 | 43,50 | 28 | 20,5 | 6,0 | 4,0 | 6 |
| 24130 | 46,20 | 30 | 21,0 | 6,0 | 4,0 | 6 |

Sartén blinis

Poêle Blinis · Pfanne Blinis
Frying pan Blinis · Sertä Blinis



| Ref | € | Ø (cm) | Ød (cm) | h(cm) | e (mm) | U.Venta |
|-------|-------|--------|---------|-------|--------|---------|
| 24114 | 13,40 | 14 | 10,0 | 5,6 | 4,0 | 1 |

Wok

Wok · Wok
Wok · Wok



| Ref | € | Ø (cm) | Ød (cm) | h(cm) | e (mm) | U.Venta |
|-------|-------|--------|---------|-------|--------|---------|
| 24138 | 44,20 | 28 | 16,0 | 9,0 | 4,0 | 1 |

Crepera

Crêpiere · Crêpes Pfanne
Crepiere · Crepeira



| Ref | € | Ø (cm) | Ød (cm) | h(cm) | e (mm) | U.Venta |
|-------|-------|--------|---------|-------|--------|---------|
| 24137 | 33,40 | 24 | 18,0 | 1,8 | 4,0 | 1 |
| 24136 | 37,10 | 26 | 17,0 | 1,8 | 4,0 | 1 |



Grill

Grill · Grill
Grill · Grelhador

| Ref | € | cm | Ød (cm) | h(cm) | e (mm) | U.Venta |
|-------|-------|-------|---------|-------|--------|---------|
| 24123 | 38,10 | 24x24 | 16,7 | 4,5 | 4,0 | 1 |
| 24127 | 45,80 | 28x28 | 19,0 | 4,5 | 4,0 | 1 |
| 24125 | 38,20 | 24x24 | 16,7 | 4,5 | 4,0 | 1 |
| 24129 | 45,90 | 28x28 | 19,0 | 4,5 | 4,0 | 1 |



Paellera

Plat à paella · Pfanne
Round dish · Paelheira

| Ref | € | Ø (cm) | Ød (cm) | h(cm) | e (mm) | Raciones | U.Venta |
|-------|-------|--------|---------|-------|--------|----------|---------|
| 25432 | 76,50 | 32 | 25,5 | 4,5 | 1,6 | 5 | 1 |
| 25436 | 81,90 | 36 | 29,5 | 4,5 | 2,0 | 7 | 1 |
| 25440 | 95,50 | 40 | 33,5 | 4,5 | 2,0 | 9 | 1 |

Incluye asas de silicona
Includes silicone handles



Plancha grill oval

Plaque à Grill · Platte Grill
Grill plaque · Plancha Grill

| Ref | € | cm | Ød (cm) | Área de cocción | h(cm) | e (mm) | U.Venta |
|-------|-------|-------------|---------|-----------------|-------|--------|---------|
| 25536 | 38,00 | 37,5x23x4,5 | 18,0 | 25,5x20 | 1,5 | 4,0 | 1 |
| 25547 | 52,70 | 47,5x29x5,5 | 21,0 | 33,5x25 | 2,0 | 4,0 | 1 |



Plancha grill

Plaque à Grill · Platte Grill
Grill plaque · Plancha Grill

| Ref | € | cm | Ød (cm) | Área de cocción | h(cm) | e (mm) | U.Venta |
|-------|-------|-----------|---------|-----------------|-------|--------|---------|
| 24134 | 66,90 | 46x27,5x6 | 24,0 | 33x25cm | 2,0 | 4,0 | 1 |
| 24135 | 69,60 | 46x27,5x6 | 24,0 | 33x25cm | 2,0 | 4,0 | 1 |

Asas Eco piedra

Poignées pour plat rond · Griffschutz for Pfanne
Handles for round dish · Asas para paelheira

| Ref | € | Ø (cm) | U.Venta |
|---------|-------|----------|---------|
| R25436A | 11,90 | 32-36-40 | 1 |



Asas para plancha grill

Poignées pour plaque à Grill · Griffschutz for Platte Grill
Handles for grill plaque · Asas para plancha Grill

| Ref | € | cm | U.Venta |
|---------|------|----|---------|
| R25736A | 4,10 | 36 | 1 |
| R25747A | 5,70 | 47 | 1 |
| R25536A | 4,10 | 36 | 1 |
| R25547A | 5,70 | 47 | 1 |

TitanFull



- Fabricada en aluminio fundido de gran calidad.
- Diseñada para cocinar todo tipo de verduras, carnes, pescados, etc. de forma saludable y sin apenas utilizar aceite.
- Ahorro energético, hasta un 45% más eficiente, gracias a su fondo FULL INDUCTION.
- Distribución homogénea del calor: permite que los alimentos se cocinen rápidamente y de manera uniforme.
- Diseñada para uso doméstico y rendimiento profesional.
- Máxima resistencia al desgaste.
- Compatible con todo tipo de cocinas.

- Fabriqué en aluminium fondu de grande qualité.
- Conçu pour cuire toutes sortes de légumes, viandes, poissons, etc. Sain et à peine utilisé de l'huile.
- Économies d'énergie, jusqu'à 45% plus efficaces, grâce à son fonds d'induction complet.
- Distribution de la chaleur homogène: permet aux aliments de cuire rapidement et uniformément.
- Conçu pour un usage domestique et des performances professionnelles.
- Résistance à l'usure maximale.
- Compatible avec tous les types de cuisines, y compris l'induction.

- Made of great quality molten aluminum.
- Designed to cook all kinds of vegetables, meats, fish, etc.
- Healthy and hardly use oil.
- Energy savings, up to 45% more efficient, thanks to its Full Induction fund.
- Homogeneous heat distribution: Allows food to cook quickly and uniformly.
- Designed for domestic use and professional performance.
- Maximum wear resistance.
- Compatible with all types of kitchens, including induction.

Incluye asas de silicona
Includes silicone handles



Plancha grill

Plaque à Grill · Platte Grill
Grill plaque · Plancha Grill

| Ref | € | Área de cocción | h(cm) | e (mm) | U.Venta |
|-------|--------|-----------------|-------|--------|---------|
| 24347 | 113,50 | 28x28 | 3 | 5,0 | 1 |

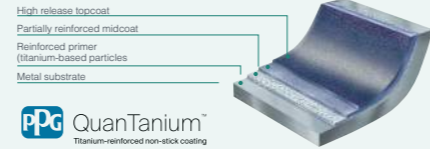

Antiadherente QuanTanium® reforzado con partículas de titanio; libre de materiales tóxicos y pesados, ecológico y libre de PFOA
Antiadhésif QuanTanium® renforcé avec des particules de titane sans matériaux toxiques ni métaux lourds, écologique et sans PFOA.
QuanTanium® non-stick reinforced with titanium particles; free from toxic and heavy materials, environmentally friendly and PFOA-free.

Sua



- Sartén parrilla grill fabricada en aluminio fundido de máxima calidad.
- Acabado antiadherente bicapa de alta calidad y 100% libre de PFOA. Libre de materiales tóxicos, pesados, disolventes y sustancias químicas.
- Diseñada para una cocina saludable: permite cocinar sin apenas aceite garantizando que los alimentos no se peguen.
- Máxima eficiencia y ahorro de energía; su fondo difusor FULL INDUCTION está especialmente diseñado para repartir el calor de manera rápida y uniforme a lo largo de toda la superficie (base + paredes), consiguiendo así que los alimentos se cocinen de forma uniforme por toda la superficie.

- Grill Sergeén Grill fabriqué en aluminium fondu de qualité maximale.
- Finition anti-bicouche de haute qualité et 100% exempt de PFOA. Sans matériaux toxiques, lourds, solvants et chimiques.
- Conçu pour une cuisine saine: il permet de cuisiner avec presque aucune huile garantissant que la nourriture ne colle pas.
- Efficacité maximale et économies d'énergie; Son fond de diffuseur complet à induction est spécialement conçu pour distribuer la chaleur rapidement et uniformément sur toute la surface (base + murs), faisant ainsi cuire les aliments uniformément sur la surface.

- Grill grill manufactured in molten aluminum of maximum quality.
- High quality bilayer anti-sticking finish and 100% free from PFOA. Free of toxic, heavy, solvents and chemical materials.
- Designed for a healthy kitchen: it allows cooking with hardly any oil guaranteeing that food does not stick.
- Maximum efficiency and energy savings; Its Full Induction diffuser background is specially designed to distribute heat quickly and uniformly along the entire surface (base + walls), thus getting food cook uniformly throughout the surface.

Mango abatible de madera de roble
Wooden folded handle



Sartén grill

Gril · Grill Induktionfähig
Grill · Grelhador

| Ref | € | cm | h(cm) | e (mm) | U.Venta |
|-------|-------|-------|-------|--------|---------|
| 25144 | 28,40 | 24x24 | 3,7 | 1,7 | 1 |
| 25148 | 34,50 | 28x28 | 3,8 | 1,7 | 1 |

Sartén grill liso

Grill lisse · Grill Induktionfähig, glatt
Grill flat · Grelhador liso

| Ref | € | cm | h(cm) | e (mm) | U.Venta |
|-------|-------|-------|-------|--------|---------|
| 25154 | 28,40 | 24x24 | 3,7 | 1,7 | 1 |
| 25158 | 34,50 | 28x28 | 3,8 | 1,7 | 1 |



Java Collection



- Fabricada en aluminio forjado de máxima calidad.
- Antiadherente interior y exterior reforzado a base de partículas de piedra.
- Ecológico, libre de materiales tóxicos y pesados. Libre de PFOA.
- Fondo FULL INDUCTION compatible con todas las fuentes de calor, incluida la inducción. Excelente conductividad térmica.

- Fabriqué en aluminium forgé de la plus grande qualité.
- Antiadhésif intérieur et extérieur renforcé à base de particules de pierre.
- Écologique, exempt de matériaux toxiques et lourds. Sans PFOA.
- Fond « FULL INDUCTION » compatible avec toutes les sources de chaleur, y compris l'induction. Excellente conductivité thermique.

- Made of high quality forged aluminum.
- Reinforced non-stick coating inside and outside using stone particles.
- Ecological, free of toxic and heavy materials. PFOA free.
- FULL INDUCTION base that can be used with all kinds of heat sources, including induction cookers. Excellent thermal conductivity.

Sartén

Poêle · Pfanne
Frying-pan · Sertã

| Ref | € | Ø (cm) | Ød (cm) | h(cm) | e (mm) | U.Venta |
|-------|-------|--------|---------|-------|--------|---------|
| 26816 | 14,40 | 16 | 13,0 | 4,0 | 3,0 | 6 |
| 26818 | 15,40 | 18 | 13,8 | 4,0 | 3,0 | 6 |
| 26820 | 16,90 | 20 | 15,6 | 4,0 | 3,0 | 6 |
| 26822 | 19,00 | 22 | 17,4 | 4,5 | 3,0 | 6 |
| 26824 | 20,60 | 24 | 19,0 | 4,5 | 3,0 | 6 |
| 26826 | 22,80 | 26 | 20,4 | 5,0 | 3,0 | 6 |
| 26828 | 24,80 | 28 | 22,4 | 5,5 | 3,0 | 6 |
| 26830 | 27,50 | 30 | 23,7 | 5,5 | 3,0 | 6 |
| 26832 | 38,20 | 32 | 25,0 | 5,5 | 3,0 | 6 |



Wok

Wok · Wok
Wok · Wok

| Ref | € | Ø (cm) | Ød (cm) | h(cm) | e (mm) | U.Venta |
|-------|-------|--------|---------|-------|--------|---------|
| 26848 | 24,40 | 28 | 17,5 | 8,0 | 3,0 | 1 |



Crepera

Crêpiere · Crêpes Pfanne
Crepiere · Crepeira

| Ref | € | Ø (cm) | Ød (cm) | h(cm) | e (mm) | U.Venta |
|-------|-------|--------|---------|-------|--------|---------|
| 26844 | 19,10 | 24 | 21,6 | 2,0 | 3,0 | 1 |



Sartén honda

Poêle profonde · Tiefe Pfanne
Deep frying-pan · Sertã funda

| Ref | € | Ø (cm) | Ød (cm) | h(cm) | e (mm) | U.Venta |
|-------|-------|--------|---------|-------|--------|---------|
| 26834 | 22,00 | 24 | 18,5 | 6,5 | 3,0 | 1 |
| 26838 | 26,00 | 28 | 22,2 | 7,0 | 3,0 | 1 |



Grill

Grill · Grill Induktionfähig
Grill · Grelhador

| Ref | € | cm | Ød (cm) | h(cm) | e (mm) | U.Venta |
|-------|-------|---------|---------|-------|--------|---------|
| 26858 | 27,80 | 28 x 28 | 24,2 | 4,5 | 3,0 | 1 |



Set Fogo



- Set de dos sartenes de aluminio forjado de máxima calidad.
- Recubrimiento antiadherente TRICapa reforzado con partículas a base de piedra, libre de materiales tóxicos y pesados.
- Ecológico y libre de PFOA.
- Ahorro energético, hasta un 45% más eficiente, gracias a su fondo difusor FULL INDUCTION.
- La base de aluminio permite una distribución homogénea del calor, permitiendo que los alimentos se cocinen rápidamente y de manera uniforme, sin apenas utilizar aceite.
- Máxima resistencia al desgaste.
- Mango ergonómico y antideslizante.
- Apilables.
- Fácil limpieza interior y exterior gracias a su protección antiadherente.

- Ensemble de deux moules en aluminium forgé de qualité maximale.
- Revêtement anti-droit à base droite avec des particules à base de pierre, exemptes de matériaux toxiques et lourds.
- Écologique et sans PFOA.
- Économies d'énergie, jusqu'à 45% plus efficaces, grâce à son fonds complet du fonds d'induction.
- La base en aluminium permet une distribution homogène de la chaleur, permettant aux aliments de cuire rapidement et uniformément, avec presque aucune huile.
- Résistance à l'usure maximale.
- Mango ergonomique et non glissant.
- Empilable.
- Nettoyage intérieur et extérieur facile grâce à sa protection non-assise.

- Set of two maximum quality wrought aluminum pans.
- Straight -based antiating coating with stone -based particles, free of toxic and heavy materials.
- Ecological and free of PFOA.
- Energy savings, up to 45% more efficient, thanks to its Full Induction Fund Fund.
- The aluminum base allows a homogeneous distribution of heat, allowing food to cook quickly and uniformly, with hardly any oil.
- Maximum wear resistance.
- Ergonomic and non -slip mango.
- Stackable.
- Easy interior and exterior cleaning thanks to its non -stick protection.
- Compatibility: all types of kitchens, including induction.

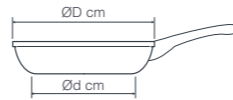

Set 2 sartenes

Set 2 poêles · Set 2 Bratpfannen
Set 2 frying pans · Conjunto 2 sertās

| Ref | € | Ø (cm) | Ød (cm) | h(cm) | e (mm) | U.Venta |
|-------|--------------|--------|---------|-------|--------|---------|
| 26400 | 34,70 | 20 | 14,5 | 4,2 | 3,0 | 1 |
| | | 24 | 18,0 | 4,7 | 3,0 | |

Vite



- Sartén fabricada en aluminio de máxima calidad.
- Máxima eficiencia y ahorro de energía; cuenta con un fondo difusor full induction para asegurar un rendimiento óptimo en todo tipo de cocinas con un reparto de calor inmejorable.
- Recubrimiento antiadherente de máxima calidad.
- Libre de materiales pesados y tóxicos, ecológico y libre de PFOA.
- Gracias a su fondo full induction, es compatible con todas las fuentes de calor, incluida la inducción.

- Singerén fabriqué en aluminium de qualité maximale.
- Efficacité maximale et économies d'énergie; Il a un diffuseur à induction complet pour assurer des performances optimales dans tous les types de cuisines avec une distribution de chaleur imbattable.
- Évaluation anticantante de la qualité maximale.
- Sans matériaux lourds et toxiques, écologiques et exempts de PFOA.
- Grâce à son fonds d'induction complet, il est compatible avec toutes les sources de chaleur, y compris l'induction.

- Singerén manufactured in aluminum of maximum quality.
- Maximum efficiency and energy savings; It has a full induction diffuser back to ensure optimal performance in all types of kitchens with an unbeatable heat distribution.
- Antiating coating of maximum quality.
- Free of heavy and toxic materials, ecological and free of PFOA.
- Thanks to its Full Induction fund, it is compatible with all heat sources, including induction.

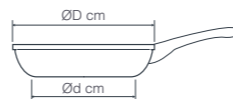

Sartén

Poêle · Pflanne
Frying-pan · Sertā

| Ref | € | Ø (cm) | Ød (cm) | h(cm) | e (mm) | U.Venta |
|-------|--------------|--------|---------|-------|--------|---------|
| 26718 | 12,70 | 18 | 11,5 | 4,0 | 3,0 | 6 |
| 26720 | 14,30 | 20 | 14,3 | 4,0 | 3,0 | 6 |
| 26722 | 16,20 | 22 | 16,6 | 4,5 | 3,0 | 6 |
| 26724 | 17,90 | 24 | 17,0 | 4,5 | 3,0 | 6 |
| 26726 | 20,40 | 26 | 19,0 | 5,0 | 3,0 | 6 |
| 26728 | 22,60 | 28 | 21,5 | 5,0 | 3,0 | 6 |
| 26730 | 24,30 | 30 | 21,2 | 5,5 | 3,0 | 6 |

Easy Collection



- Fabricada en aluminio forjado de máxima calidad.
- Recubrimiento antiadherente Whitford reforzado de máxima calidad y libre de PFOA.
- Antiadherente interior reforzado a base de partículas de piedra.
- Fondo full induction compatible con todas las fuentes de calor, incluida la inducción.
- Excelente conductividad térmica.
- Mango de fundición de acero inoxidable.

- Fabriqué en aluminium forgé de qualité maximale.
- Straid Whitford revêtement renforcé et exempt de PFOA.
- Basé sur Internet basé sur Internet.
- Fonds complet à induction compatible avec toutes les sources de chaleur, y compris l'induction.
- Excellente conductivité thermique.
- Poignée coulée en acier inoxydable.

- Made of maximum quality forged aluminum.
- Straid Whitford Coating Reinforced and free of PFOA.
- Internal internet based based based based.
- Full Induction Fund compatible with all heat sources, including induction.
- Excellent thermal conductivity.
- Stainless steel casting mango.

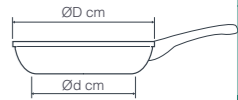

Sartén Easy

Poêle · Pflanne
Frying-pan · Sertā

| Ref | € | Ø (cm) | h(cm) | e (mm) | L | U.Venta |
|-------|--------------|--------|-------|--------|------|---------|
| 27018 | 21,10 | 18 | 4,0 | 3,0 | 0,75 | 6 |
| 27020 | 21,90 | 20 | 4,0 | 3,0 | 1,0 | 6 |
| 27022 | 23,70 | 22 | 4,5 | 3,0 | 1,3 | 6 |
| 27024 | 25,70 | 24 | 4,5 | 3,0 | 1,7 | 6 |
| 27026 | 27,90 | 26 | 5,0 | 3,0 | 2,1 | 6 |
| 27028 | 30,60 | 28 | 5,5 | 3,0 | 2,7 | 6 |
| 27030 | 33,50 | 30 | 5,5 | 3,0 | 3,1 | 6 |
| 27032 | 35,40 | 32 | 6,0 | 3,0 | 3,7 | 6 |



Sartén Honda

Poêle profonde · Tiefs Pflanne
Deep frying-pan · Sertā funda

| Ref | € | Ø (cm) | Ød (cm) | h(cm) | e (mm) | U.Venta |
|-------|--------------|--------|---------|-------|--------|---------|
| 27134 | 31,20 | 24 | 16,00 | 6,5 | 3,0 | 1 |
| 27138 | 37,30 | 28 | 21,00 | 7,0 | 3,0 | 1 |



Wok

Wok · Wok
Wok · Wok

| Ref | € | Ø (cm) | Ød (cm) | h(cm) | e (mm) | U.Venta |
|-------|--------------|--------|---------|-------|--------|---------|
| 27148 | 35,00 | 28 | 16,00 | 8,0 | 3,0 | 1 |



Grill

Grill · Grill Inductionfāhing
Grill · Grelhador

| Ref | € | cm | h(cm) | e (mm) | U.Venta |
|-------|--------------|-------|-------|--------|---------|
| 27158 | 38,50 | 28x28 | 4,0 | 3,0 | 1 |



Crepera

Crépiere · Crêpes Pflanne
Crepiere · Crepeira

| Ref | € | Ø (cm) | Ød (cm) | h(cm) | e (mm) |
|-------|--------------|--------|---------|-------|--------|
| 27144 | 27,60 | 19,0 | 4,0 | 3,0 | 1 |

Voga



- Fabricada en aluminio forjado, acabado fuerte y robusto.
- Calentamiento rápido y uniforme.
- Recubrimiento antiadherente ILAG:ULTIMATE (tricapa) de gran calidad ultrarresistente y de uso intensivo.
- Mango de acero inoxidable, no se calienta.

- Fabriqué en aluminium forgé, une finition solide et robuste.
- Réchauffement rapide et uniforme.
- ILAG: Ultimate (Tricapa) revêtement antiadhérent (Tricapa) d'une grande utilisation ultra-résistante et intensive.
- Mango en acier inoxydable, ne chauffez pas.

- Made of forged aluminium, strong and robust finish.
- Fast and uniform warming.
- ILAG: Ultimate (tricapa) antiadherent coating (tricapa) of great ultra-resistant and intensive use.
- Stainless steel mango, do not heat up.

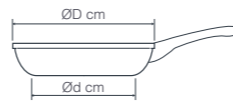

Sartén Voga

Poêle · Pfanne
Frying-pan · Sertä

| Ref | € | Ø (cm) | Ød (cm) | h(cm) | e (mm) | U.Venta |
|-------|-------|--------|---------|-------|--------|---------|
| 24720 | 33,40 | 20 | 14,6 | 4,5 | 4,0 | 6 |
| 24722 | 36,50 | 22 | 15,6 | 5,0 | 4,0 | 6 |
| 24724 | 40,90 | 24 | 17,7 | 5,0 | 4,0 | 6 |
| 24726 | 45,20 | 26 | 18,8 | 5,5 | 4,0 | 6 |
| 24728 | 48,40 | 28 | 20,4 | 6,0 | 4,0 | 6 |
| 24732 | 56,40 | 32 | 23,3 | 6,5 | 4,0 | 6 |

Fit



- Gracias al tratamiento electrolítico empleado en su proceso de fabricación, el aluminio se sella completamente y se endurece para que no pase a los alimentos.
- Gran durabilidad y ultrarresistente: superficie robusta altamente resistente a roces, deformación y corrosión.
- Difunde el calor de forma uniforme evitando el sobrecalentamiento y obteniendo excelentes resultados de cocción.
- Mango de acero inoxidable con remaches de aluminio que impiden la transferencia de calor.
- Compatible con todas las fuentes de calor, incluida la inducción.

- Grâce au traitement électrolytique utilisé dans son processus de fabrication, l'aluminium est complètement scellé et durcit afin qu'il ne passe pas à la nourriture.
- Grande durabilité et ultra-résistant: surface robuste très résistante aux frictions, à la déformation et à la corrosion.
- Diffuser la chaleur uniformément en évitant de surchauffer et obtenir d'excellents résultats de cuisson.
- Mango en acier inoxydable avec des rivets en aluminium qui empêchent le transfert de chaleur.
- Compatible avec toutes les sources de chaleur, y compris l'induction.

- Thanks to the electrolytic treatment used in its manufacturing process, aluminum is completely sealed and hardens so that it does not pass to food.
- Great durability and ultra-resistant: robust surface highly resistant to friction, deformation and corrosion.
- Disseminate heat evenly avoiding overheating and obtaining excellent cooking results.
- Stainless steel mango with aluminum rivets that prevent heat transfer.
- Compatible with all heat sources, including induction.

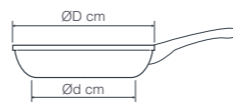

Sartén

Poêle · Pfanne
Frying pan · Sertä

| Ref | € | Ø (cm) | Ød (cm) | h(cm) | e (mm) | U.Venta |
|-------|-------|--------|---------|-------|--------|---------|
| 48720 | 33,20 | 20 | 15,0 | 4,0 | 4,5 | 6 |
| 48724 | 41,50 | 24 | 18,0 | 4,5 | 4,5 | 6 |
| 48728 | 49,50 | 28 | 22,0 | 5,0 | 4,5 | 6 |

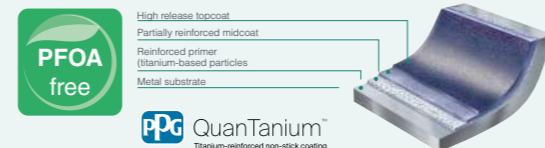

Antiadherente Quantanium® reforzado con partículas de titanio; libre de materiales tóxicos y pesados, ecológico y libre de PFOA
Antiadhésif Quantanium® renforcé avec des particules de titane sans matériaux toxiques ni métaux lourds, écologique et sans PFOA.
Quantanium® non-stick reinforced with titanium particles; free from toxic and heavy materials, environmentally friendly and PFOA-free.

Loft



- Fabricada en aluminio embutido, acabado fuerte y robusto.
- Recubrimiento antiadherente. Calidad y larga duración.
- Exterior en negro mate.
- Calentamiento rápido y uniforme.

- Fabriquée en aluminium embouti, finition forte et robuste.
- Revêtement antiadhésif. Qualité et longue durée de vie.
- Extérieur en noir mat.
- Chauffe rapide et uniforme.

- Made from deep drawn aluminium, strong and robust finish.
- Non-stick coating. Quality and long life.
- Outside in matte black.
- Quick and uniform heating.

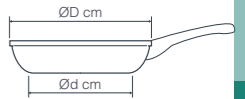

Mango SOFT TOUCH
SOFT TOUCH handle

Sartén

Poêle · Pfanne
Frying pan · Sertä

| Ref | € | Ø (cm) | Ød (cm) | h(cm) | e (mm) | U.Venta |
|-------|-------|--------|---------|-------|--------|---------|
| 24918 | 19,40 | 18 | 13,5 | 3,8 | 3,5 | 6 |
| 24920 | 21,30 | 20 | 14,7 | 4,3 | 3,5 | 6 |
| 24922 | 22,90 | 22 | 16,5 | 4,3 | 3,5 | 6 |
| 24924 | 25,60 | 24 | 17,6 | 4,8 | 3,5 | 6 |
| 24926 | 27,30 | 26 | 19,0 | 4,8 | 3,5 | 6 |
| 24928 | 31,50 | 28 | 22,1 | 5,3 | 3,5 | 6 |





Trimetal Collection



- **Cuerpo fabricado en 3 capas: acero inoxidable 18/10, aluminio, acero inoxidable 18%.**
- **La capa exterior es de acero inoxidable con componentes ferríticos, lo que la convierte totalmente compatible con las cocinas de inducción.**
- **Mango fabricado en acero inoxidable 18/10 y recubierto con un protector térmico de silicona para facilitar un agarre perfecto y seguro.**

- Corps fabriqué en 3 couches: 18/10 en acier inoxydable, aluminium, 18% en acier inoxydable.
- La couche externe est en acier inoxydable avec des composants ferritiques, ce qui le rend entièrement compatible avec les cuisines à induction.
- Mango en acier inoxydable 18/10 et recouvert d'un protecteur thermique en silicone pour faciliter une adhérence parfaite et sûre.

- Body manufactured in 3 layers: 18/10 stainless steel, aluminum, 18% stainless steel.
- The outer layer is stainless steel with ferritic components, which makes it fully compatible with induction kitchens.
- Mango made of stainless steel 18/10 and covered with a silicone thermal protector to facilitate a perfect and safe grip.



Sartén antiadherente

Poêle antiadherent · Pflanne, Antihalt
Non-stick frying pan · Sertã anti-aderente

| Ref | € | Ø (cm) | h(cm) | e (mm) | U.Venta |
|-------|--------|--------|-------|--------|---------|
| 53721 | 69,90 | 20 | 4,5 | 2,3 | 1 |
| 53725 | 83,60 | 24 | 5,0 | 2,3 | 1 |
| 53729 | 105,60 | 28 | 5,5 | 2,3 | 1 |

Sartén

Poêle · Pflanne
Frying pan · Sertã

| Ref | € | Ø (cm) | h(cm) | e (mm) | U.Venta |
|-------|-------|--------|-------|--------|---------|
| 53720 | 59,40 | 20 | 4,5 | 2,3 | 1 |
| 53724 | 66,20 | 24 | 5,0 | 2,3 | 1 |
| 53728 | 81,10 | 28 | 5,5 | 2,3 | 1 |



Wok antiadherente

Wok, Antiadherent · Wok, Antihalt
Wok, non-stick · Wok anti-aderente

| Ref | € | Ø (cm) | h(cm) | e (mm) | U.Venta |
|-------|--------|--------|-------|--------|---------|
| 53829 | 100,20 | 28 | 8,0 | 2,3 | 1 |

Wok

Wok · Wok
Wok · Wok

| Ref | € | Ø (cm) | h(cm) | e (mm) | U.Venta |
|-------|-------|--------|-------|--------|---------|
| 53828 | 88,10 | 28 | 8,0 | 2,3 | 1 |

TriChef



- **El aluminio interior garantiza una distribución rápida y uniforme del calor, así como un importante ahorro en el uso de la energía.**
- **Mango ergonómico fabricado en fundición de acero inoxidable 18/10 de gran calidad.**
- **Apta para todo tipo de cocinas, especialmente para la inducción.**
- **Máxima garantía en cuanto a resistencia, durabilidad e higiene.**
- **Apta para el horno (hasta 260°C) y lavavajillas.**

- L'aluminium intérieur garantit une distribution rapide et uniforme de chaleur, ainsi que d'importantes économies d'énergie.
- Poignée ergonomique fabriquée en fonte d'acier inoxydable 18/10 de grande qualité.
- Apte pour tous types de cuisinières, particulièrement l'induction.
- Garantie maximale en termes de résistance, durabilité et hygiène.
- Apte pour le four (jusqu'à 260°C) et le lave-vaisselle.

- The aluminium layer inside ensures fast, even heat distribution to the food and significant energy saving costs.
- Ergonomic handles made of high quality 18/10 cast stainless steel.
- Suitable for all hobs, especially induction.
- Maximum guarantee in terms of strength, durability and hygiene.
- Oven (up to 260°) and dishwasher safe.

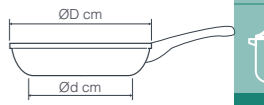

- 1.- Acero inoxidable 18/10 · 18/10 stainless steel
- 2.- Aluminio · Aluminium
- 3.- Acero inoxidable inducción · Induction stainless steel

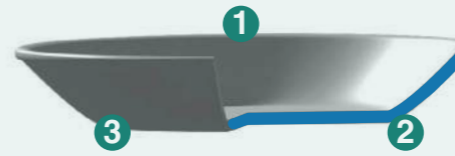

High release topcoat
Partially reinforced midcoat
Reinforced primer
(titanium-based particles)
Metal substrate

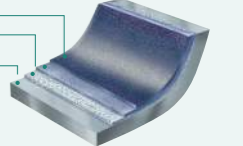

Antiadherente QuanTanium® reforzado con partículas de titanio; libre de materiales tóxicos y pesados, ecológico y libre de PFOA

Antiadhésif QuanTanium® renforcé avec des particules de titane sans matériaux toxiques ni métaux lourds, écologique et sans PFOA.

QuanTanium® non-stick reinforced with titanium particles; free from toxic and heavy materials, environmentally friendly and PFOA-free.



Sartén

Poêle · Pflanne
Frying pan · Sertã

| Ref | € | Ø (cm) | Ød (cm) | h(cm) | e (mm) | U.Venta |
|-------|-------|--------|---------|-------|--------|---------|
| 60850 | 31,70 | 20 | 16,5 | 4,3 | 2,5 | 1 |
| 60854 | 39,60 | 24 | 20,5 | 4,8 | 2,5 | 1 |
| 60858 | 48,10 | 28 | 24,5 | 5,3 | 2,5 | 1 |



Sartén antiadherente

Poêle antiadherent · Pflanne, Antihalt
Non-stick frying pan · Sertã anti-aderente

| Ref | € | Ø (cm) | Ød (cm) | h(cm) | e (mm) | U.Venta |
|-------|-------|--------|---------|-------|--------|---------|
| 60950 | 37,50 | 20 | 16,5 | 4,3 | 2,5 | 1 |
| 60954 | 46,00 | 24 | 20,5 | 4,8 | 2,5 | 1 |
| 60958 | 56,20 | 28 | 24,5 | 5,3 | 2,5 | 1 |

Sartén Vitrocor



- **Fabricada en acero inoxidable 18/10 de la mejor calidad.**
- **Máxima garantía en cuanto a resistencia, durabilidad e higiene.**
- **Fondo termodifusor sándwich, distribución rápida y uniforme del calor.**
- **Homogeneidad y eficacia térmica. Cocción ultrarrápida.**
- **Apta para todos los fuegos.**

- Made of stainless steel 18/10 of the best quality.
- Maximum guarantee in terms of resistance, durability and hygiene.
- Sandwich thermodifusor background, rapid and uniform distribution of heat.
- Homogeneity and thermal efficacy. Ultra-grape cooking.
- Suitable for all fires.



Sartén Vitrocor

Poêle · Pflanne
Frying pan · Sertã

| Ref | € | Ø (cm) | h(cm) | e (mm) | U.Venta |
|-------|-------|--------|-------|--------|---------|
| 40619 | 33,80 | 18 | 4,5 | 0,7 | 1 |
| 40621 | 36,00 | 20 | 4,5 | 0,7 | 1 |
| 40623 | 37,30 | 22 | 5,0 | 0,7 | 1 |
| 40625 | 39,90 | 24 | 5,2 | 0,7 | 1 |
| 40627 | 41,10 | 26 | 6,0 | 0,7 | 1 |
| 40629 | 44,10 | 28 | 6,5 | 0,7 | 1 |

Home collection



- **Máxima garantía en cuanto a resistencia, durabilidad e higiene.**
- **Antiadherente Eclipse Plus tricapa de uso intensivo. Libre de PFOA.**
- **Fondo termodifusor sándwich; distribución rápida y uniforme del calor.**
- **Homogeneidad y eficacia térmica. Cocción ultrarrápida.**

- Garantie maximale en termes de résistance, de durabilité et d'hygiène.
- Éclipse anticulante plus tricap d'utilisation intensive. PFOA gratuit.
- Fond de thermodifusor sandwich; Distribution rapide et uniforme de la chaleur.
- Homogénéité et efficacité thermique. Cuisine ultra-graphe.

- Maximum guarantee in terms of resistance, durability and hygiene.
- Antiating Eclipse Plus tricap of intensive use. PFOA free.
- Sandwich thermodifusor background; Quick and uniform distribution of heat.
- Homogeneity and thermal efficacy. Ultra-grape cooking



Sartén lisa

Poêle, lisse · Pflanne, glatt
Frying-pan flat · Sertã

| Ref | € | Ø (cm) | h(cm) | e (mm) | U.Venta |
|-------|-------|--------|-------|--------|---------|
| 71318 | 38,90 | 18 | 5,5 | 0,7 | 1 |
| 71320 | 40,90 | 20 | 5,5 | 0,7 | 1 |
| 71322 | 45,50 | 22 | 5,5 | 0,7 | 1 |
| 71324 | 49,80 | 24 | 6,0 | 0,7 | 1 |
| 71326 | 54,80 | 26 | 6,0 | 0,7 | 1 |
| 71328 | 61,40 | 28 | 6,5 | 0,7 | 1 |



Sartén acanalada

Poêle · Pflanne
Frying-pan · Sertã

| Ref | € | Ø (cm) | h(cm) | e (mm) | U.Venta |
|-------|-------|--------|-------|--------|---------|
| 71818 | 38,90 | 18 | 5,5 | 0,7 | 1 |
| 71820 | 40,90 | 20 | 5,5 | 0,7 | 1 |
| 71822 | 45,50 | 22 | 5,5 | 0,7 | 1 |
| 71824 | 49,80 | 24 | 6,0 | 0,7 | 1 |
| 71826 | 54,80 | 26 | 6,0 | 0,7 | 1 |
| 71828 | 61,40 | 28 | 6,5 | 0,7 | 1 |

Sartenes Combi



Mango

Poignée · Griff
Handle · Cabo

| Ref | € | Color | U.Venta |
|-------|-------|---------------|---------|
| 56601 | 14,60 | Negro · Black | 1 |
| 56605 | 14,80 | Azul · Blue | 1 |
| 56603 | 14,80 | Rojo · Red | 1 |



Ahorra espacio de almacenaje
Saves storage space



Cuerpo para tartera/sartén Combi

Corps pourplat rond/poêle · Körper für Pflanne/Pflanne
Body for round dish/frying pan · Corpo para tarteira/sertã

| Ref | € | Ø (cm) | h(cm) | e (mm) | L | U.Venta |
|-------|-------|--------|-------|--------|------|---------|
| 56720 | 24,30 | 20 | 4,0 | 0,8 | 1,00 | 1 |
| 56724 | 30,20 | 24 | 4,5 | 0,8 | 2,00 | 1 |
| 56728 | 41,00 | 28 | 5,0 | 0,8 | 3,00 | 1 |
| 56732 | 48,90 | 32 | 5,5 | 0,8 | 4,00 | 1 |



Cuerpo para tartera/sartén Combi antiadherente

Corps pourplat rond/poêle · Körper für Pflanne/Pflanne
Body for round dish/frying pan · Corpo para tarteira/sertã

| Ref | € | Ø (cm) | h(cm) | e (mm) | L | U.Venta |
|-------|-------|--------|-------|--------|------|---------|
| 56820 | 31,70 | 20 | 4,0 | 0,8 | 1,00 | 1 |
| 56824 | 38,40 | 24 | 4,5 | 0,8 | 2,00 | 1 |
| 56828 | 51,10 | 28 | 5,0 | 0,8 | 3,00 | 1 |
| 56832 | 59,30 | 32 | 5,5 | 0,8 | 4,00 | 1 |



Foodie collection



- **Fabricada en acero inoxidable 18/10.**
- **Mango ergonómico fabricado en acero inoxidable fundido.**
- **Natural y ecológica. Libre de materiales tóxicos y pesados.**
- **Fondo termo difusor sándwich, distribución rápida y homogénea del calor.**
- **Máxima garantía en cuanto a resistencia, durabilidad e higiene.**
- **Acabado interior y exterior lijado satinado.**

- Fabriqué en acier inoxydable 18/10.
- Mango ergonomique en acier inoxydable coulé.
- Naturel et écologique. Sans matériaux toxiques et lourds.
- Sandwich au diffuseur Thermo Fund, distribution rapide et homogène de la chaleur.
- Garantie maximale en termes de résistance, de durabilité et d'hygiène.
- Satin de finition interne et extérieure.

- Made of stainless steel 18/10.
- Ergonomic mango made of cast stainless steel.
- Natural and ecological. Free of toxic and heavy materials.
- Thermo Fund diffuser sandwich, rapid and homogeneous distribution of heat.
- Maximum guarantee in terms of resistance, durability and hygiene.
- Internal and exterior finish satin.

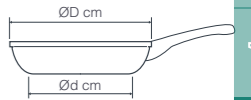

Sartén Foodie

Poêle · Pflanne
Frying pan · Sertã

| Ref | € | Ø (cm) | Ød (cm) | h(cm) | e (mm) | U.Venta |
|-------|-------|--------|---------|-------|--------|---------|
| 45420 | 28,10 | 20 | 13,5 | 5,5 | 0,6 | 1 |
| 45422 | 29,90 | 22 | 14,5 | 5,5 | 0,6 | 1 |
| 45424 | 33,50 | 24 | 17,5 | 6,0 | 0,6 | 1 |
| 45426 | 35,60 | 26 | 19,0 | 6,0 | 0,6 | 1 |
| 45428 | 39,40 | 28 | 19,5 | 6,5 | 0,6 | 1 |
| 45430 | 40,60 | 30 | 22,0 | 6,5 | 0,6 | 1 |



Sartén antiadherente Foodie

Poêle antiadherent · Pflanne, Antihäft
Frying-pan, non-stick · Sertã anti-aderente

| Ref | € | Ø (cm) | Ød (cm) | h(cm) | e (mm) | U.Venta |
|-------|-------|--------|---------|-------|--------|---------|
| 45320 | 33,10 | 20 | 13,5 | 5,5 | 0,6 | 1 |
| 45322 | 34,30 | 22 | 14,5 | 5,5 | 0,6 | 1 |
| 45324 | 40,50 | 24 | 17,5 | 6,0 | 0,6 | 1 |
| 45326 | 41,50 | 26 | 19,0 | 6,0 | 0,6 | 1 |
| 45328 | 48,50 | 28 | 19,5 | 6,5 | 0,6 | 1 |
| 45330 | 49,60 | 30 | 22,0 | 6,5 | 0,6 | 1 |



Wok

Wok · Wok
Wok · Wok

| Ref | € | Ø (cm) | Ød (cm) | h(cm) | U.Venta |
|-------|-------|--------|---------|-------|---------|
| 45828 | 40,00 | 28 | 15,6 | 8,0 | 1 |



Wok antiadherente

Wok antiadherent · Wok, Antihäft
Wok, non-stick · Wok anti-aderenter

| Ref | € | Ø (cm) | Ød (cm) | h(cm) | U.Venta |
|-------|-------|--------|---------|-------|---------|
| 45728 | 48,20 | 28 | 15,6 | 8,0 | 1 |



Crepera

Crêpière · Crêpes-Pflanne
Crepiere · Crepeira

| Ref | € | Ø (cm) | Ød (cm) | h(cm) | U.Venta |
|-------|-------|--------|---------|-------|---------|
| 45829 | 39,50 | 28 | 24 | 1,8 | 1 |



Crepera antiadherente

Crêpière antiadherent · Crêpes-Pflanne, Antihäft
Crepiere, non-stick · Crepeira anti-aderenter

| Ref | € | Ø (cm) | Ød (cm) | h(cm) | U.Venta |
|-------|-------|--------|---------|-------|---------|
| 45729 | 42,30 | 28 | 24 | 1,8 | 1 |



Sartenes Origin

INOX 18/10



- Fabricada en acero inoxidable 18/10 de la mejor calidad.
- Mango fabricado en acero inoxidable con recubrimiento PVD (proceso de chapado iónico con titanio, metal de gran dureza).
- Máxima garantía en cuanto a resistencia, durabilidad e higiene.
- Fondo termodifusor sandwich (inox 18/10 - aluminio - inoxidable).
- Distribución rápida y uniforme del calor.

- Fabriquées en acier inoxydable 18/10 de la meilleure qualité.
- Poignée en acier inoxydable avec revêtement PVD (procédé de placage ionique avec du titane, métal de haute dureté).
- Garantie maximale en termes de résistance, de durabilité et d'hygiène.
- Fond thermodiffuseur sandwich (Inox 18/10 - Aluminium - Inoxydable)
- Distribution rapide et uniforme de la chaleur.

- Made of the highest quality 18/10 stainless steel.
- Handle made of stainless steel with PVD coating (ionic plating process with titanium, high hardness metal).
- Maximum guarantee in terms of resistance, durability and hygiene.
- Heat-diffusing sandwiched base (18/10 stainless steel - aluminium - st. Steel)
- Quick and even heat distribution..

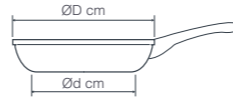

Sartén Origin

Poêle · Pflanne
Frying pan · Sertã

| Ref | € | Ø (cm) | Ød (cm) | h(cm) | e (mm) | U.Venta |
|-------|-------|--------|---------|-------|--------|---------|
| 47318 | 25,00 | 18 | 12,5 | 4,00 | 0,6 | 1 |
| 47320 | 27,80 | 20 | 12,5 | 4,20 | 0,6 | 1 |
| 47322 | 30,00 | 22 | 16,8 | 4,40 | 0,6 | 1 |
| 47324 | 31,90 | 24 | 18,5 | 4,60 | 0,6 | 1 |
| 47328 | 35,70 | 28 | 21,2 | 4,80 | 0,6 | 1 |
| 47330 | 38,80 | 30 | 23,0 | 5,00 | 0,6 | 1 |

Sartén antiadherente Origin

Poêle antiadherent · Pflanne, Antihafit
Frying-pan, non-stick · Sertã anti-aderente

| Ref | € | Ø (cm) | Ød (cm) | h(cm) | e (mm) | U.Venta |
|-------|-------|--------|---------|-------|--------|---------|
| 47418 | 29,60 | 18 | 12,5 | 4,00 | 0,6 | 1 |
| 47420 | 32,80 | 20 | 12,5 | 4,20 | 0,6 | 1 |
| 47422 | 35,20 | 22 | 16,8 | 4,40 | 0,6 | 1 |
| 47424 | 37,50 | 24 | 18,5 | 4,60 | 0,6 | 1 |
| 47428 | 42,50 | 28 | 21,2 | 4,80 | 0,6 | 1 |
| 47430 | 46,30 | 30 | 23,0 | 5,00 | 0,6 | 1 |

Sartenes Cuisine

INOX 18/10



- Fabricadas en acero inoxidable 18/10 de máxima calidad.
- Mango ergonómico de acero inoxidable.
- Máxima garantía en resistencia, durabilidad e higiene.
- Distribución rápida y uniforme del calor gracias a su fondo FULL INDUCTION.

- Fabriqué en acier inoxydable 18/10 de la plus haute qualité.
- Poignée ergonomique en acier inoxydable.
- Garantie maximale de résistance, durabilité et d'hygiène.
- Diffusion rapide et uniforme de la chaleur grâce à son fond à INDUCTION TOTALE.

- Made of the highest quality 18/10 stainless steel quality.
- Ergonomic stainless steel handle.
- Maximum guarantee of resistance, durability and hygiene.
- Fast and uniform heat distribution thanks to its FULL INDUCTION bottom.

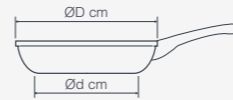

new



Sartenes Cuisine

Poêle · Pflanne
Frying pans · Sertã

| Ref | € | Ø (cm) | Ød (cm) | h(cm) | e (mm) | U.Venta |
|-------|-------|--------|---------|-------|--------|---------|
| 44420 | 24,30 | 20 | 13,5 | 5,0 | 0,5 | 1 |
| 44424 | 29,10 | 24 | 17,5 | 6,0 | 0,5 | 1 |
| 44428 | 33,90 | 28 | 19,5 | 6,5 | 0,5 | 1 |

Sartén antiadherente Cuisine

Poêle antiadherent · Pflanne, Antihafit
Frying-pan, non-stick · Sertã anti-aderente

| Ref | € | Ø (cm) | Ød (cm) | h(cm) | e (mm) | U.Venta |
|-------|-------|--------|---------|-------|--------|---------|
| 44320 | 27,90 | 20 | 13,5 | 5,0 | 0,5 | 1 |
| 44324 | 34,50 | 24 | 17,5 | 6,0 | 0,5 | 1 |
| 44328 | 41,60 | 28 | 19,5 | 6,5 | 0,5 | 1 |



Paelleras

Paella pans

Paelleras Inoxidables

INOX
18/10



Paellera con tapa Chef Luxe

Plat rond avec couvercle · Pflanne mit Deckel
Round dish with lid · Paelheira com tampa

| Ref | € | Ø (cm) | h(cm) | e (mm) | L | U.Venta |
|---------|--------|--------|-------|--------|-------|---------|
| 54636 | 174,10 | 36 | 7,0 | 1,5 | 7,00 | 1 |
| 54640 | 211,90 | 40 | 8,0 | 1,5 | 10,00 | 1 |
| 54645 | 245,40 | 45 | 8,5 | 2,0 | 12,00 | 1 |
| * 54650 | 309,70 | 50 | 9,0 | 2,0 | 17,00 | 1 |

* NO inducción · NON induction · NOT Induction



Paellera con tapa Chef Classic

Plat rond a/couvercle · Pflanne mit Deckel
Round with lid · Paelheira com tampa

| Ref | € | Ø (cm) | h(cm) | e (mm) | L | U.Venta |
|---------|--------|--------|-------|--------|-------|---------|
| 50624 | 64,80 | 24 | 6,0 | 0,8 | 2,70 | 1 |
| 50628 | 87,70 | 28 | 6,0 | 0,8 | 3,60 | 1 |
| 50632 | 113,20 | 32 | 6,0 | 0,8 | 5,00 | 1 |
| 50636 | 143,40 | 36 | 7,0 | 1,0 | 7,10 | 1 |
| 50640 | 165,00 | 40 | 8,0 | 1,0 | 10,00 | 1 |
| 50645 | 193,80 | 45 | 8,5 | 1,0 | 13,50 | 1 |
| 50650 | 251,40 | 50 | 9,0 | 1,0 | 17,60 | 1 |
| * 50660 | 363,40 | 60 | 9,0 | 1,0 | 25,40 | 1 |

* NO inducción · NON induction · NOT Induction



Paellera sin tapa Wagner

Plat rond s/couvercle · Pflanne ohne Deckel
Round dish without lid · Paelheira sem tampa

| Ref | € | Ø (cm) | h (cm) | e (mm) | L | U.Venta |
|----------|--------|--------|--------|--------|-------|---------|
| 50624W | 52,10 | 24 | 6,0 | 0,8 | 2,70 | 1 |
| 50628W | 69,10 | 28 | 6,0 | 0,8 | 3,60 | 1 |
| 50632W | 85,80 | 32 | 6,0 | 0,8 | 5,00 | 1 |
| 50636W | 116,60 | 36 | 7,0 | 1,0 | 7,10 | 1 |
| 50640W | 133,40 | 40 | 8,0 | 1,0 | 10,00 | 1 |
| 50645W | 153,60 | 45 | 8,5 | 1,0 | 13,50 | 1 |
| 50650W | 207,70 | 50 | 9,0 | 1,0 | 17,60 | 1 |
| * 50660W | 295,90 | 60 | 9,0 | 1,0 | 25,40 | 1 |

* NO inducción · NON induction · NOT Induction



Paellera sin tapa Chef Luxe

Plat rond s/couvercle · Pflanne ohne Deckel
Round dish without lid · Paelheira sem tampa

| Ref | € | Ø (cm) | U.Venta |
|----------|--------|--------|---------|
| 54636S | 137,80 | 36 | 1 |
| 54640S | 170,80 | 40 | 1 |
| 54645S | 198,30 | 45 | 1 |
| * 54650S | 253,50 | 50 | 1 |

* NO inducción · NON induction · NOT Induction



Paellera sin tapa Chef Classic

Plat rond s/couvercle · Pflanne ohne Deckel
Round dish without lid · Paelheira sem tampa

| Ref | € | Ø (cm) | U.Venta |
|----------|--------|--------|---------|
| 50624S | 49,60 | 24 | 1 |
| 50628S | 70,30 | 28 | 1 |
| 50632S | 90,20 | 32 | 1 |
| 50636S | 115,60 | 36 | 1 |
| 50640S | 133,80 | 40 | 1 |
| 50645S | 156,50 | 45 | 1 |
| 50650S | 205,60 | 50 | 1 |
| * 50660S | 303,60 | 60 | 1 |

* NO inducción · NON induction · NOT Induction



Paellera sin tapa Eco Chef

Plat rond sans couvercle · Pflanne ohne Deckel
Round without lid · Paelheira sem tampa

| Ref | € | Ø (cm) | h(cm) | e (mm) | L | U.Venta |
|-------|--------|--------|-------|--------|-------|---------|
| 57624 | 38,70 | 24 | 6,5 | 0,7 | 3,00 | 1 |
| 57628 | 53,60 | 28 | 6,5 | 0,7 | 4,00 | 1 |
| 57632 | 68,50 | 32 | 7,0 | 0,7 | 5,00 | 1 |
| 57636 | 94,30 | 36 | 7,0 | 0,9 | 7,10 | 1 |
| 57640 | 108,70 | 40 | 8,0 | 0,9 | 10,00 | 1 |



Paellera Valenciaiana

Plat à paella · Paellapfanne
Round dish for paella · Paelheira valenciana

| Ref | € | Ø (cm) | h(cm) | Raciones | e (mm) | U.Venta |
|-------|--------|--------|-------|----------|--------|---------|
| 60130 | 63,50 | 30 | 4,1 | 4 | 0,6 | 1 |
| 60134 | 76,40 | 34 | 4,1 | 6 | 0,6 | 1 |
| 60138 | 90,90 | 38 | 4,2 | 8 | 0,6 | 1 |
| 60142 | 111,10 | 42 | 4,5 | 10 | 0,6 | 1 |
| 60146 | 132,00 | 46 | 4,6 | 12 | 0,7 | 1 |
| 60150 | 170,90 | 50 | 4,8 | 14 | 0,7 | 1 |
| 60155 | 217,60 | 55 | 5,2 | 16 | 0,8 | 1 |
| 60160 | 270,50 | 60 | 4,9 | 18 | 0,8 | 1 |



Paellera Valenciaiana antiadherente

Plat à paella anti-adhésif · Paellapfanne, Antihaf
Round dish for paella non-stick · Paelheira valenciana anti-aderente

| Ref | € | Ø (cm) | Raciones | U.Venta |
|-------|--------|--------|----------|---------|
| 60232 | 79,10 | 32 | 5 | 1 |
| 60236 | 93,50 | 36 | 7 | 1 |
| 60240 | 113,00 | 40 | 9 | 1 |

- 1.- Acero inoxidable 18/10 · 18/10 stainless steel
- 2.- Aluminio · Aluminium
- 3.- Acero inoxidable inducción · Induction stainless steel

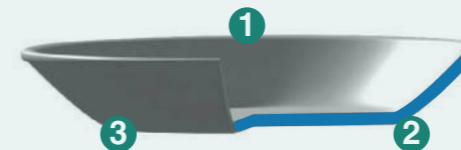

- El aluminio interior garantiza una distribución rápida y uniforme del calor, así como un importante ahorro en el uso de la energía.
- Asas ergonómicas fabricadas en fundición de acero inoxidable 18/10 de gran calidad.
- Aptas para todo tipo de cocinas, especialmente para la inducción.
- Máxima garantía en cuanto a resistencia, durabilidad e higiene.
- Aptas para el horno (hasta 260°C) y lavavajillas.

- The aluminium layer inside ensures fast, even heat distribution to the food and significant energy saving costs.
- Ergonomic handles made of high quality 18/10 cast stainless steel.
- Suitable for all hobs, especially induction.
- Maximum guarantee in terms of strength, durability and hygiene.
- Oven (up to 260°) and dishwasher safe.

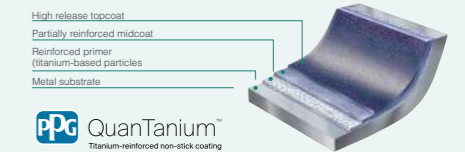

- Antiadherente QuanTanium® reforzado con partículas de titanio; libre de materiales tóxicos y pesados, ecológico y libre de PFOA
- Antiadhésif QuanTanium® renforcé avec des particules de titane sans matériaux toxiques ni métaux lourds, écologique et sans PFOA.
- QuanTanium® non-stick reinforced with titanium particles; free from toxic and heavy materials, environmentally friendly and PFOA-free.



Paellera TriChef

Plat à paella · Pflanne
Round dish · Paelheira

| Ref | € | Ø (cm) | Ød (cm) | h(cm) | Raciones | U.Venta |
|-------|-------|--------|---------|-------|----------|---------|
| 60834 | 44,70 | 34 | 25 | 5,0 | 5 | 1 |
| 60840 | 56,10 | 40 | 30 | 6,0 | 6 | 1 |



Paellera TriChef antiadherente

Plat à paella, antiadhesive · Paellapfanne, Antihaf
Round dish for paella, non stick · Paelheira anti-aderente

| Ref | € | Ø (cm) | Ød (cm) | h(cm) | Raciones | U.Venta |
|-------|-------|--------|---------|-------|----------|---------|
| 60833 | 57,90 | 34 | 25 | 5,0 | 5 | 1 |
| 60839 | 73,20 | 40 | 30 | 6,0 | 6 | 1 |

Paelleras aluminio



Full Induction
TOTAL



- Fabricada en aluminio fundido de gran calidad y espesor.
- Recubrimiento antiadherente TRICapa reforzado con partículas a base de piedra, libre de materiales tóxicos y pesados.
- Ecológico y libre de PFOA.
- Ahorro energético, hasta un 45% más eficiente, gracias a su fondo FULL INDUCTION.
- La base de aluminio permite una distribución homogénea del calor, permitiendo que los alimentos se cocinen rápidamente y de manera uniforme, sin apenas utilizar aceite.
- Diseñada para uso doméstico y rendimiento profesional.
- Máxima resistencia al desgaste.
- Fácil limpieza interior y exterior gracias a su protección antiadherente.
- Compatibilidad: todo tipo de cocinas, incluida la inducción.

- Manufactured in molten aluminum of high quality and thickness.
- Straight -based antiating coating with stone -based particles, free of toxic and heavy materials.
- Ecological and free of PFOA.
- Energy savings, up to 45% more efficient, thanks to its Full Induction fund.
- The aluminum base allows a homogeneous distribution of heat, allowing food to cook quickly and uniformly, with hardly any oil.
- Designed for domestic use and professional performance.
- Maximum wear resistance.
- Easy interior and exterior cleaning thanks to its non -stick protection.
- Compatibility: all types of kitchens, including induction.



Asas para paellera EcoPiedra

Poignées pour plat rond · Griffschutz for Pfanne
Handles for round dish · Asas para paellera



| Ref | € | Ø (cm) | U.Venta |
|---------|-------|----------|---------|
| R25436A | 11,90 | 32-36-40 | 1 |

- Fabricada en aluminio fundido.
- Garantiza la absorción y distribución uniforme del calor, sin puntos de sobrecalentamiento.
- La distribución del calor uniforme por toda la pieza hace que los alimentos no pierdan su jugo durante la cocción, conservando así todos sus nutrientes y vitaminas.
- Fondo difusor FULL INDUCTION; asegura un rendimiento óptimo en todo tipo de cocinas con un reparto de calor inmejorable logrando la máxima eficiencia y ahorro de energía.
- Perfecta para arroces, carnes, pescados, legumbres, verduras, guisos, cremas, salsas, sopas, etc.
- Revestimiento antiadherente Xylan Plus.
- Diseño atractivo y funcional.
- Compatible con todo tipo de cocinas, incluida la inducción.

- Manufactured in molten aluminum.
- It guarantees the uniform absorption and distribution of heat, without overheating points.
- The distribution of uniform heat throughout the piece causes food not to lose their juice during cooking, thus retaining all its nutrients and vitamins.
- Full Induction Diffuser Fund; ensures optimal performance in all types of kitchens with an unbeatable heat distribution achieving maximum efficiency and energy saving.
- Perfect for rice, meats, fish, legumes, vegetables, stews, creams, sauces, soups, etc.
- Antiating Coating Xylan Plus.
- Attractive and functional design.
- Compatible with all types of kitchens, including induction.



Paellera Cocotte

Plat rond · Pfanne
Round · Paelheira

| Ref | € | Ø (cm) | Ød (cm) | h(cm) | e (mm) | Raciones | U.Venta |
|-------|--------|--------|---------|-------|--------|----------|---------|
| 25932 | 84,30 | 32 | 25,5 | 4,5 | 1,6 | 5 | 1 |
| 25936 | 98,50 | 36 | 29,5 | 4,5 | 2,0 | 7 | 1 |
| 25940 | 109,50 | 40 | 33,5 | 4,5 | 2,0 | 9 | 1 |



Paellera Chef aluminio

Plat rond · Pfanne
Round · Paelheira

| Ref | € | Ø (cm) | h(cm) | e (mm) | L | U.Venta |
|-------|--------|--------|-------|--------|-------|---------|
| 20628 | 42,90 | 28 | 7,0 | 2,5 | 4,30 | 1 |
| 20630 | 45,60 | 30 | 6,5 | 2,5 | 4,75 | 1 |
| 20632 | 48,80 | 32 | 7,0 | 2,5 | 5,50 | 1 |
| 20634 | 51,60 | 34 | 7,0 | 2,5 | 6,35 | 1 |
| 20636 | 54,50 | 36 | 7,5 | 2,5 | 7,45 | 1 |
| 20638 | 55,40 | 38 | 7,5 | 3,0 | 8,60 | 1 |
| 20640 | 65,10 | 40 | 8,0 | 3,0 | 10,05 | 1 |
| 20645 | 71,20 | 45 | 8,0 | 3,0 | 12,50 | 1 |
| 20650 | 83,00 | 50 | 8,0 | 3,0 | 15,50 | 1 |
| 20660 | 118,70 | 60 | 10,0 | 3,5 | 28,00 | 1 |

Paelleras Master



Paellera robust

Plat rond · Paellapfanne
Round dish · Paelheira

| Ref | € | Ø (cm) | h(cm) | U.Venta |
|-------|-------|--------|-------|---------|
| 23724 | 23,40 | 24 | 4,00 | 1 |
| 23728 | 30,70 | 28 | 4,50 | 1 |
| 23732 | 36,20 | 32 | 5,00 | 1 |
| 23736 | 43,70 | 36 | 5,50 | 1 |
| 23740 | 54,00 | 40 | 6,00 | 1 |



Paellera Steel Pro

Plat à paella · Paellapfanne
Round dish for paella · Paelheira

| Ref | € | Ø (cm) | h(cm) | Raciones | U.Venta |
|-------|--------|--------|-------|----------|---------|
| 63621 | 6,90 | 20 | 4,0 | 1 | 6 |
| 63623 | 7,00 | 22 | 3,5 | 1 | 6 |
| 63625 | 7,30 | 24 | 3,7 | 1 | 6 |
| 63627 | 8,00 | 26 | 3,7 | 2 | 6 |
| 63629 | 8,30 | 28 | 4,1 | 3 | 6 |
| 63631 | 9,00 | 30 | 4,2 | 4 | 6 |
| 63633 | 10,10 | 32 | 5,0 | 5 | 6 |
| 63635 | 10,90 | 34 | 4,6 | 6 | 6 |
| 63637 | 11,70 | 36 | 5,0 | 7 | 1 |
| 63639 | 13,20 | 38 | 5,0 | 8 | 1 |
| 63641 | 14,30 | 40 | 5,0 | 9 | 1 |
| 63643 | 16,40 | 42 | 5,0 | 10 | 1 |
| 63647 | 18,50 | 46 | 5,0 | 12 | 1 |
| 63651 | 22,00 | 50 | 5,5 | 14 | 1 |
| 63656 | 36,00 | 55 | 5,5 | 16 | 1 |
| 63661 | 42,50 | 60 | 5,0 | 19 | 1 |
| 63666 | 52,70 | 65 | 5,5 | 22 | 1 |
| 63671 | 75,00 | 70 | 6,0 | 25 | 1 |
| 63681 | 103,00 | 80 | 7,1 | 40 | 1 |
| 63691 | 143,90 | 90 | 8,0 | 50 | 1 |
| 63115 | 429,00 | 115 | 9,0 | 120 | 1 |
| 63130 | 890,80 | 130 | 12,0 | 200 | 1 |

Paellera Ferrum

Plat à paella · Paellapfanne
Round dish for paella · Paelheira

| Ref | € | Ø (cm) | h(cm) | e (mm) | Raciones | U.Venta |
|-------|-------|--------|-------|--------|----------|---------|
| 63928 | 58,70 | 28 | 4,5 | 2,5 | 3 | 1 |
| 63932 | 66,50 | 32 | 4,7 | 2,5 | 5 | 1 |
| 63936 | 82,90 | 36 | 5,5 | 2,5 | 7 | 1 |
| 63940 | 91,30 | 40 | 5,5 | 2,5 | 9 | 1 |

Asas de acero inoxidable
Stainless steel handles





Paellera antiadherente Steel

Plat à paella, antiadhesive · Paellapfanne, Antihaft
Round dish for paella, non stick · Paelheira anti-aderente

| Ref | € | Ø (cm) | Raciones | U.Venta |
|-------|-------|--------|----------|---------|
| 60127 | 22,40 | 28 | 3 | 1 |
| 60131 | 25,30 | 32 | 5 | 1 |
| 60135 | 29,30 | 36 | 7 | 1 |
| 60139 | 32,90 | 40 | 9 | 1 |
| 60144 | 43,90 | 45 | 12 | 1 |
| 60149 | 53,00 | 50 | 14 | 1 |
| 60159 | 67,20 | 60 | 19 | 1 |



Esmalte vitrificado
Vitrified enamel

Paellera Smalt

Plat à paella · Paellapfanne, emailliert
Round dish for paelle · Paelheira esmaltada

| Ref | € | Ø (cm) | Raciones | U.Venta |
|-------|-------|--------|----------|---------|
| 60170 | 5,20 | 10 | 1 | 1 |
| 60172 | 5,90 | 12 | 1 | 1 |
| 60175 | 6,90 | 15 | 1 | 1 |
| 60180 | 8,80 | 20 | 1 | 1 |
| 60184 | 10,70 | 24 | 1 | 1 |
| 60188 | 13,00 | 28 | 3 | 1 |
| 60182 | 17,90 | 32 | 5 | 1 |
| 60186 | 20,00 | 36 | 7 | 1 |
| 60141 | 24,70 | 40 | 9 | 1 |
| 60151 | 37,80 | 50 | 14 | 1 |
| 60161 | 59,50 | 60 | 19 | 1 |

Accesorios para paelleras

Diseñado para el soporte paellero ref.: 63700
Designed for base for burner



Paellero Gas Butano

Rechaud · Brenner
Burner · Paelheira gás butanos

| Ref | € | Ø (cm) | W | Presión | Quemadores | U.Venta | Paelleras recomendadas |
|-------|--------|----------|-------|---------|------------|---------|--------------------------------|
| 63731 | 48,00 | 30 | 6500 | 37 | 1 | 1 | Ø36-38-40-42-46 |
| 63741 | 83,00 | 20-40 | 11400 | 37 | 2 | 1 | Ø28-30-32-34-36-46-50-55 |
| 63751 | 109,70 | 30-50 | 14100 | 37 | 2 | 1 | Ø38-40-42-46-60-65-70 |
| 63761 | 154,50 | 20-40-60 | 21000 | 37 | 3 | 1 | Ø28-30-32-34-36-46-50-55-70-80 |
| 63771 | 254,00 | 30-50-70 | 24500 | 37 | 3 | 1 | Ø38-40-42-46-60-65-70-80-90 |

Regulable para distintas medidas
Adjustable for different measures



Soporte paellero

Pied pour rechaud · Stände für Brenner
Base for burner · Cuporte paelheria

| Ref | € | Ø (cm) | h(cm) | U.Venta |
|-------|-------|----------|-------|---------|
| 63700 | 47,60 | Hasta 60 | 70 | 1 |

Válido para propano y butano · NO válidas Gas Natural y Gas Ciudad
Valid for propane and butane · NOT valid Natural Gas and Gas City

Rostideras / Horno

Roasting pans / Oven



Inox 18/10



- Gran calidad, resistencia, tamaño y capacidad, muy útiles en la cocina.
- Ideales para la cocción de platos y asados al horno.
- Soportan sin problemas temperaturas altas.
- Excelente resistencia a la corrosión y a los ácidos alimentarios y sales.
- Asas atérmicas.

- Grande qualité, robustesse, taille et capacité, très utiles dans la cuisine.
- Idéal pour la cuisson de plats et de rôtis au four.
- Supporte sans problèmes des températures élevées.
- Excellente résistance à la corrosion et aux sels et acides alimentaires.
- Poignées athermiques.

- Great quality, durability, size and capacity, very useful in the kitchen.
- Ideal for cooking dishes and roasts in the oven.
- Easily withstands high temperatures.
- Excellent resistance to corrosion and to food acids and salts.
- Heat-resistant handles.



Rustidera Inox

Plat à rotir · Lasagneform
Roaster · Assadeira

| Ref | € | cm | L | h(cm) | e (mm) | U.Venta |
|-------|-------|-------|-----|-------|--------|---------|
| 62530 | 33,70 | 30x21 | 3,4 | 5,5 | 0,7 | 1 |
| 62535 | 44,50 | 35x26 | 5,0 | 5,5 | 0,7 | 1 |
| 62540 | 56,60 | 40x31 | 7,4 | 6,0 | 0,8 | 1 |



Rustidera Chef Inox

Couvercle · Deckel
Lid · Tampa

| Ref | € | cm | h(cm) | e (mm) | U.Venta |
|-------|--------|-------|-------|--------|---------|
| 50540 | 118,40 | 40x30 | 8,0 | 1,0 | 1 |
| 50550 | 156,80 | 50x40 | 8,0 | 1,0 | 1 |
| 50560 | 197,50 | 60x45 | 8,0 | 1,0 | 1 |
| 50570 | 225,60 | 70x45 | 9,5 | 1,0 | 1 |



INOX

Rustidera asas abatibles

Plat à gratin anse tombante · Bratpfanne mit Fallgriffen
Roaster moving handles · Assadeira asa abatível

| Ref | € | cm | h(cm) | e (mm) | L | U.Venta |
|-------|-------|-------|-------|--------|------|---------|
| 61530 | 16,30 | 30x22 | 5,0 | 0,5 | 3,3 | 1 |
| 61535 | 20,70 | 35x26 | 6,0 | 0,6 | 4,8 | 1 |
| 61540 | 26,50 | 40x28 | 6,5 | 0,7 | 6,2 | 1 |
| 61545 | 39,20 | 45x32 | 7,5 | 0,8 | 10,8 | 1 |
| 61550 | 73,00 | 50x36 | 8,0 | 0,8 | 15,3 | 1 |



Rustidera honda asas abatibles

Plat à rotir anse tombante · Bratpfanne mit Fallgriffen
Roaster moving handles · Assadeira funda asa abatível

| Ref | € | cm | h(cm) | e (mm) | L | U.Venta |
|--------|-------|-------|-------|--------|------|---------|
| 62530A | 37,30 | 30x22 | 7,5 | 0,7 | 4,9 | 1 |
| 62535A | 45,40 | 35x26 | 8,0 | 0,7 | 7,0 | 1 |
| 62540A | 54,00 | 40x28 | 8,0 | 0,7 | 9,5 | 1 |
| 62545A | 62,70 | 45x32 | 9,0 | 0,8 | 12,9 | 1 |



INOX

Bandeja con rejilla Essential

Plat à four avec grille · Backblech mit Gitter
Tray with rack · Bandeja com grelha



Rejilla extraíble
Removable rack

| Ref | € | cm | h(cm) | U.Venta |
|-------|-------|-----------|-------|---------|
| 15562 | 10,20 | 21,5x15 | 2,0 | 1 |
| 15563 | 12,60 | 23,5x15,5 | 2,5 | 1 |
| 15566 | 15,50 | 26,5x20,5 | 2,5 | 1 |
| 15567 | 25,70 | 40,5x30,5 | 2,5 | 1 |

- Bandeja con rejilla extraíble fabricada en acero inoxidable de gran calidad.
- Borde de acero encapsulado reforzado que evita la deformación.
- Alta conductividad térmica: distribuye el calor de manera uniforme proporcionando resultados de cocción óptimos.
- Funcional y versátil: Con la rejilla podrás asar todo tipo de carnes, enfriar galletas, deshidratar frutas, etc. Sin la rejilla, podrás estofar guisos, asar todo tipo de verduras incluso hornear tu bizcocho favorito.
- Apta para el horno, frigorífico y congelador.

- High quality stainless steel tray with removable rack.
- Reinforced encapsulated steel rim to prevent warping.
- High thermal conductivity for even heat distribution and optimum cooking results.
- Highly functional and versatile: use the rack to roast all kinds of meat, to cool biscuits, dehydrate fruit, etc., or remove it to make casseroles, roast all kinds of vegetables and even bake your own favourite sponge cake!.
- Oven, fridge and freezer safe.

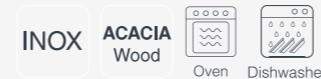
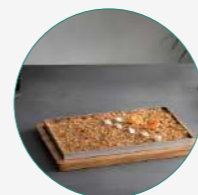

Llauna de arroz

Plateau de présentation du riz · Reisblech
Stainless steel rice tray · Bandeja para arroz

| Ref | € | cm | h(cm) | U.Venta |
|-------|-------|-------|-------|---------|
| 60830 | 28,20 | 33x23 | 3,0 | 1 |

- Compuesta por una bandeja de acero inoxidable de gran calidad y base de madera de acacia.
- La bandeja está diseñada para cocinar al horno y barbacoas todo tipo de arroces, guisos, carnes y pescados.
- La base de madera de acacia es perfecta para resaltar las presentaciones en la mesa.
- Medidas de llauna: 29,5x19,5x2 cm
- Medidas base de madera: 33x23x1,7 cm (No apta para el horno y lavavajillas).
- Medidas totales: 33x23x3 cm.

- Composé d'un plateau en acier inoxydable de haute qualité et d'une base en bois d'acacia.
- Le plateau est conçu pour la cuisson au four et au barbecue de tous les types de riz, de ragoûts, de plats de viande et de poisson.
- La base en bois d'acacia est parfaite pour mettre en valeur les présentations sur la table.
- Dimensions de riz plateau : 29,5x19,5x2 cm.
- Dimensions de la base en bois : 33x23x1,7 cm (ne va pas au four ni au lave-vaisselle).
- Dimensions totales : 33x23x3 cm.

- Composed of a high quality stainless steel tray and acacia wood base.
- The tray is designed for baking and barbecuing all types of rice, stews, meat and fish dishes.
- The acacia wood base is perfect for highlighting presentations on the table.
- Measurements of rice llauna: 29,5x19,5x2 cm.
- Wooden base dimensions: 33x23x1,7 cm (not oven and dishwasher safe).
- Total dimensions: 33x23x3 cm



Aluminio



- **Distribución homogénea del calor por toda la superficie.**
- **Recubrimiento antiadherente de gran calidad, resistente a arañazos y ralladuras.**
- **Ecológico, libre de materiales tóxicos y pesados. Libre de PFOA.**
- **Robustos y resistentes a las deformaciones y a la abrasión.**
- **Ideal para hornear y gratinar todo tipo de alimentos.**
- **Asas diseñadas para un agarre seguro y cómodo.**

- Distribution homogène de la chaleur sur toute la surface.
- Revêtement antiadhésif de grande qualité, résistant aux rayures.
- Écologique, sans matériaux toxiques ni métaux lourds. Sans PFOA.
- Robuste et résistant à la déformation et à l'abrasion.
- Idéal pour une utilisation au four et pour gratiner tout type d'aliments.
- Poignées conçues pour une prise en mains sûre et pratique.

- Heat is distributed evenly over the entire surface.
- It has a high quality non-stick coating that is scratch and scrape resistant.
- It's environmentally friendly and free of toxic materials and heavy metals. It's PFOA free.
- The inside and outside have a matte black finish.
- It's sturdy and resists warping and scratches.
- It's perfect for baking and cooking all kinds of foods.
- The handles are designed for a safe and comfortable grip.

Asa de tubo de acero inoxidable 18/10
Handles in a 18/10 stainless steel tube



Rustidera con asas fijas

Plat à rotir anse fixe · Bratpfanne, m. feststehenden Griffen
Roaster fix handle · Assadeira com asa fixa

| Ref | € | cm | h(cm) | e (mm) | L | U.Venta |
|--------|--------|-------|-------|--------|-------|---------|
| 20540F | 55,40 | 40x30 | 6,2 | 2,5 | 7,45 | 1 |
| 20545F | 59,40 | 45x32 | 6,2 | 2,5 | 10,40 | 1 |
| 20550F | 74,60 | 50x35 | 7,0 | 3,0 | 12,60 | 1 |
| 20555F | 81,00 | 55x37 | 7,7 | 3,0 | 16,30 | 1 |
| 20560F | 87,60 | 60x40 | 7,7 | 3,0 | 18,95 | 1 |
| 20565F | 97,40 | 65x43 | 7,9 | 3,0 | 24,30 | 1 |
| 20570F | 103,00 | 70x45 | 9,0 | 3,0 | 28,65 | 1 |

Rustidera con asas abatibles

Plat à rotir anse tombante · Bratpfanne mit Fallgriffen
Roaster moving handle · Assadeira com asa abatível

| Ref | € | cm | h(cm) | e (mm) | L | U.Venta |
|--------|--------|-------|-------|--------|-------|---------|
| 20540A | 55,40 | 40x30 | 6,2 | 2,5 | 7,45 | 1 |
| 20545A | 59,40 | 45x32 | 6,2 | 2,5 | 10,40 | 1 |
| 20550A | 74,60 | 50x35 | 7,0 | 3,0 | 12,60 | 1 |
| 20555A | 81,00 | 55x37 | 7,7 | 3,0 | 16,30 | 1 |
| 20560A | 87,00 | 60x40 | 7,7 | 3,0 | 18,95 | 1 |
| 20565A | 97,40 | 65x43 | 7,9 | 3,0 | 24,30 | 1 |
| 20570A | 103,00 | 70x45 | 9,0 | 3,0 | 28,65 | 1 |



Rustidera aluminio fundido antiderente

Plat à gratin en aluminium fondu, antiadherent · Bratpfanne, Aluminium, Antihaft
Aluminium cast roaster, non-stick · Assadeira alumínio fundido anti-aderente

| Ref | € | cm | h(cm) | U.Venta |
|-------|-------|-------|-------|---------|
| 25534 | 62,00 | 34x28 | 8,0 | 1 |



* Para la rustidera 25534 · For the 25534 roaster

Tapa de cristal rustidera

Couvercle en verre pour plat à rôtir · Deckel Glas für Bratpfanne
Lid glass for roaster · Tampa de vidro para assadeira

| Ref | € | cm | h(cm) | U.Venta |
|-------|-------|-------|-------|---------|
| 25539 | 15,00 | 34x28 | 8 | 1 |



Rustidera Intense

Couvercle · Deckel
Lid · Tampa

| Ref | € | cm | h(cm) | e (mm) | L | U.Venta |
|-------|-------|-------|-------|--------|-----|---------|
| 15720 | 14,60 | 20x15 | 4,7 | 1,50 | 1,2 | 1 |
| 15725 | 17,40 | 25x19 | 5,0 | 2 | 2,0 | 1 |
| 15730 | 23,40 | 30x22 | 5,7 | 3 | 3,1 | 1 |
| 15735 | 31,60 | 35x26 | 6,3 | 4,50 | 4,7 | 1 |



AL
Aluminium

Bandeja Master

Plateau · Platte
Tray · Bandeja

| Ref | € | cm | h(cm) | U.Venta |
|-------|-------|-------|-------|---------|
| 68465 | 23,70 | 45x33 | 5,0 | 1 |
| 68466 | 24,80 | 53x38 | 2,5 | 1 |



Rustidera Robust

Plat à rotir a/tombante, antiadherent · Bratpfanne mit Fallgriffen, Aluminium, Antihaft
Roaster Robust moving handle, non-stick · Assadeira c/asa abatível anti-aderente

| Ref | € | cm | h(cm) | U.Venta |
|--------|-------|-------|-------|---------|
| 23540A | 63,30 | 40x30 | 6,2 | 1 |
| 23550A | 77,00 | 50x35 | 7,0 | 1 |

- **Calidad premium: fabricadas en aluminio natural; 99,5% de pureza.**
- **Garantizan una conductividad térmica superior, con una distribución homogénea del calor permitiendo así que todas las elaboraciones se doren y se horneen de forma uniforme.**
- **Especialmente diseñadas para profesionales de la repostería, cocinas exigentes y de alta producción.**
- **Ligeras, resistentes e indeformables, fácil manejo.**
- **Limpieza: Se recomienda lavarlas a mano con un jabón y una esponja no abrasivos. No aptas para el lavavajillas.**
- **Consejos de uso: se recomienda usar tanto papel / tapete para hornear.**

- Qualité premium : Fabriqué en aluminium naturel ; 99,5% de pureté.
- Garantit une conductivité thermique supérieure avec une distribution homogène de la chaleur, permettant ainsi à toutes les préparations culinaires de dorer et cuire de façon uniforme.
- Spécialement conçu pour les professionnels de la pâtisserie, les cuisines exigeantes et de grande production.
- Léger, résistant et indéformable ; facile à manipuler.
- Nettoyage : il est recommandé de le laver à la main avec du savon et une éponge non abrasifs. Ne peut pas aller au lave-vaisselle.
- Conseils d'utilisation : il est recommandé d'utiliser du papier sulfurisé ou un tapis de cuisson pour cuire les aliments.

- Premium quality: made from 99.5% pure natural aluminium.
- Guarantees excellent thermal conductivity and homogeneous heat distribution, allowing all baked goods to brown and bake evenly.
- Specially designed for professional bakers, demanding and busy chefs, high output kitchens.
- Lightweight, robust, non-deformable and easy to handle.
- Cleaning: cleaning by hand with detergent and a non-abrasive sponge is recommended. Not dishwasher safe.
- Instructions for use: baking mats and baking paper are both recommended.

Parrillas · Placas · Pinzas

INOX  
Oven Dishwasher

Varilla · Rod: Ø2 mm

Varilla · Rod: Ø5 mm

Parrilla Due

Grille · Gitter, Rost
Grate · Grelha

| Ref | € | cm | h(cm) | U.Venta |
|-------|-------|-------|-------|---------|
| 68741 | 30,60 | 60x40 | 0,8 | 1 |

INOX 
Oven

Parrilla Tri

Grille · Gitter, Rost
Grate · Grelha

| Ref | € | cm | Medidas Cubeta | U.Venta |
|-------|-------|---------|----------------|---------|
| 66920 | 55,10 | 65x53 | 2/1 | 1 |
| 66921 | 21,20 | 53x32,5 | 1/1 | 1 |

AL
Aluminium

Placa horno antiadherente

Plaque à four aluminium anti-adhésif teflon · Backblech, Aluminium, Teflon
Teflon non-stick coated oven aluminium tray · Placa forno alumínio anti-aderente

| Ref | € | cm | h(cm) | U.Venta |
|-------|-------|--------|-------|---------|
| 68660 | 38,20 | 60x40 | 1,0 | 1 |
| 68659 | 34,70 | GN 1/1 | 1,0 | 1 |

Placa horno inox

Plaque à four · Backblech
Baking sheet · Placa de forno

| Ref | € | cm | h(cm) | U.Venta |
|-------|-------|--------|-------|---------|
| 68740 | 45,40 | 60x40 | 0,8 | 1 |
| 68739 | 35,10 | GN 1/1 | 0,8 | 1 |

SI 200°C
Silicone Max

Pinza para bandeja GN

Pince inox pour bac Gastronom · Zange für GN Behälter
Tong GN tray · Pinça para forno e bandejas GN

| Ref | € | Largo (cm) | U.Venta |
|----------------|-------|------------|---------|
| A 62989 | 17,50 | 20 | 12 |
| B 62998 | 17,50 | 20 | 12 |



Tapetes

INOX  
Oven Dishwasher



- Fabricado en rayón.
- Para bridar, albardar, atar asados y rellenos.
- Con soporte de almacenaje.
- Apto para horno. Temperatura max. 230°C

- Manufactured in Rayón.
- To give up, albardar, tie roasts and fillings.
- With storage support.
- Apt for oven. Max temperature. 230°C

Cordel cocina

Fil de cuisine · Küchenschnur
Kitchen string · Fio de cozinha

| Ref | € | m | U.Venta |
|-------|------|----|---------|
| 61414 | 6,20 | 80 | 6 |

Flexible, antiadherente y reutilizable
Flexible, non-stick and reusable

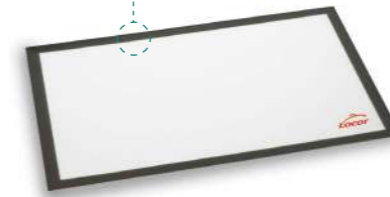

Tapete silicona White

Tapis en silicone · Backblech-Auflage Silikon
Silicone covering · Tapete de silicone

| Ref | € | cm | U.Venta |
|-------|-------|-------|---------|
| 66749 | 20,80 | 30x40 | 1 |
| 66731 | 28,90 | 60x40 | 1 |
| 66732 | 21,40 | 52x32 | 1 |



Fibra de vidrio Fibreglass  

Fácil de cortar
Easy to cut

Láminas antiadherentes

Feuilles antiadhésif · Antihaf-Bblätter
Non-stick sheets · Láminas antiaderentes

| Ref | € | cm | Unidad | U.Venta |
|-------|-------|-------|--------|---------|
| 66746 | 10,10 | 30x40 | 3 | 1 |

Incluye · Includes:

- 1.- Tablas de conversión de temperatura (°C / °F)
- 2.- Peso (gr / oz)
- 3.- Volumen ml / floz / pt)
- 4.- Longitud (mm / inch)
- 5.- Reglas laterales (cm / inch)

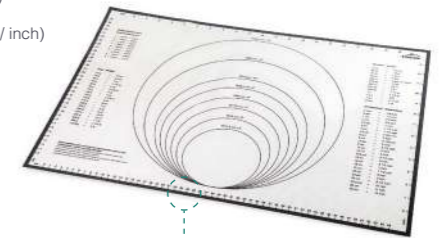

Flexible, antiadherente y reutilizable
Flexible, non-stick and reusable

Tapete silicona impreso

Tapis en silicone imprime · Bedruckte Silikonmatte
Printed silicon mat · Tapete de silicone impreso

| Ref | € | cm | U.Venta |
|-------|-------|-------|---------|
| 66759 | 29,70 | 60x40 | 1 |



Flexible, antiadherente y reutilizable
Flexible, non-stick and reusable

Tapete microperforado White

Tapis microperforé · Mikro-perforierte Matte
Micro-perforated mat · Tapete microperforado

| Ref | € | cm | U.Venta |
|-------|-------|--------|---------|
| 66794 | 8,20 | 30x40 | 1 |
| 66796 | 15,60 | 60x40 | 1 |
| 66799 | 11,10 | GN 1/1 | 1 |

- Papel de horno para freidora de aire, horno, deshidratador y moldes repostería.
- Hoja de cocción fabricada en fibra de vidrio.
- Reutilizable, más de 1.000 hornados.
- 100% flexible, se adapta a todo tipo de cestillos, moldes, bandejas, etc.
- Antiadherente por ambos lados.
- Medidas: 30x40 cm.
- Soporta temperaturas hasta 250°C.
- Libre de PFOA.

- Air frying, oven, dehydrator and baking paper.
- Cooking sheet manufactured in fiberglass.
- Reusable, more than 1,000 baked.
- 100% flexible, adapts to all types of baskets, molds, trays, etc.
- Uniautator on both sides.
- Measures: 30x40 cm.
- Supports temperatures up to 250°C.
- PFOA free.



Guantes de cocina



- **Materiales de alta calidad y protección contra el calor por contacto.**
- **Permite manipular todo tipo de utensilios de cocina con total seguridad.**
- **Combina la resistencia al calor con la flexibilidad y comodidad.**
- **Manga que cubre la mayor parte del antebrazo**

- Matériaux de grande qualité et une haute protection contre la chaleur pour contacts.
- Permet de manipuler tout type d'ustensiles de cuisine en toute sécurité.
- Allie la résistance à la chaleur à la flexibilité et le confort.
- Manche qui recouvre une grande partie de l'avant-bras.

- High quality materials and excellent heat protection by contact.
- Lets you handle all kinds of cooking utensils with complete safety.
- Combines heat resistance with flexibility and the comfort.
- The sleeve covers most of your forearm.



- **Exterior: 100% silicona y antebrazo 100% algodón. Interior y forro: 100% poliéster.**
- **Máxima Seguridad: Permite manipular todo tipo de utensilios de cocina con total seguridad.**
- **Gran resistencia a altas temperaturas. Ofrece resistencia al calor por contacto.**
- **Flexibilidad y comodidad. Extralargo; cubre la mayor parte del antebrazo.**
- **Antideslizante: Diseñado para un agarre cómodo y seguro.**
- **Ambidiestro.**
- **Práctica lengüeta para colgarlo en la cocina.**

- Extérieur : 100% silicone et avant-bras : 100% coton. Intérieur et doublure : 100% polyester.
- Sécurité maximale : permet de manipuler tous les types d'ustensiles de cuisine en toute sécurité.
- Haute résistance aux températures élevées. Offre une résistance à la chaleur de contact.
- Flexibilité et confort. Extra long ; couvre la plus grande partie de l'avant-bras.
- Antidérapant : conçu pour une prise en main confortable et sûre.
- Ambidextre.
- Patte pratique pour suspendre dans la cuisine.

- Outer: 100% silicone and forearm 100% cotton. Interior and lining: 100% polyester.
- Maximum safety: Allows handling all types of kitchen utensils in total safety.
- High resistance to high temperatures. Offers resistance to contact heat.
- Flexibility and comfort. Extra long; covers most of the forearm.
- Non-slip: Designed for a comfortable and secure grip.
- Ambidextrous.
- Practical tab for hanging in the kitchen.

Guante de cocina Vichy

Gant de cuisine · Küchenhandschuh
Kitchen glove · Luva de cozinha

| Ref | € | Largo (cm) | U.Venta |
|-------|-------|------------|---------|
| 60056 | 11,30 | 35 | 1 |



Guante de cocina Safe

Gant de cuisine · Küchenhandschuh
Kitchen glove · Luva de cozinha

| Ref | € | Largo (cm) | U.Venta |
|-------|-------|------------|---------|
| 61034 | 10,40 | 32 | 6 |



Guante de cocina Salve

Gant de cuisine · Küchenhandschuh
Kitchen glove · Luva de cozinha

| Ref | € | Largo (cm) | U.Venta |
|-------|-------|------------|---------|
| 61033 | 22,90 | 33 | 1 |



Guante de cocina Black

Gant de cuisine · Küchenhandschuh
Kitchen glove · Luva de cozinha

| Ref | € | Largo (cm) | U.Venta |
|-------|-------|------------|---------|
| 60070 | 12,80 | 36 | 1 |
| 60073 | 13,60 | 43 | 1 |



Guante algodón aluminizado

Gant de cuisine coton aluminisé · Küchehandschuh, Baumwolle, Aluminisierte
Aluminized cotton oven glove · Luva de cozinha de algodão alumínio

| Ref | € | Largo (cm) | U.Venta |
|-------|------|------------|---------|
| 61024 | 6,20 | 24 | 1 |
| 61030 | 7,30 | 30 | 1 |
| 61036 | 7,90 | 36 | 1 |



2 pcs

Guante de cocina Universal

Gant de cuisine · Küchenhandschuh
Kitchen glove · Luva de cozinha

| Ref | € | cm | U.Venta |
|---------|-------|----|---------|
| A 60062 | 35,60 | 32 | 1 |
| B 60068 | 38,70 | 48 | 1 |

- **Capa de algodón 100% adicional en el interior que aumenta la comodidad y la durabilidad**
- Additional 100% cotton layer inside. Provides comfort and durability



Guante de cocina Red

Gant de cuisine · Küchenhandschuh
Kitchen glove · Luva de cozinha

| Ref | € | cm | U.Venta |
|-------|-------|----|---------|
| 60034 | 13,20 | 27 | 1 |

- **No utilizar por separado**
- Do not use the glove separately



Guante de cocina Orka Tex

Gant de cuisine · Küchenhandschuh
Kitchen glove · Luva de cozinha

| Ref | € | Largo (cm) | U.Venta |
|-------|-------|------------|---------|
| 60041 | 32,00 | 29 | 12 |

Guante de cocina Orka

Gant de cuisine · Küchenhandschuh
Kitchen glove · Luva de cozinha

| Ref | € | Largo (cm) | U.Venta |
|-------|-------|------------|---------|
| 60010 | 38,10 | 29 | 1 |
| 60011 | 62,50 | 42 | 1 |

Protectores



- Mango protector de silicona de alta calidad para sartenes.
- Fácil de colocar, se ajusta perfectamente al mango de la sartén.
- Antideslizante y termorresistente, protege de las temperaturas elevadas.
- Compatible con nuestras sartenes Robust, Ferrum, Dynamic y Tricapa Plus (Ø16-32).

- High quality silicone protector mango for pans.
- Easy to place, it fits perfectly to the mango of the pan.
- Non-slip and thermor resistant, protects from high temperatures.
- Compatible with our Robust, Ferrum, Dynamic and Tricapa Plus (Ø16-32).

Protector de silicona

Protection en silicone · Silikonschutz
Silicone handle cover · Protector de silicona

| Ref | € | Largo (cm) | U.Venta |
|-------|------|------------|---------|
| 23900 | 6,60 | 13,5 | 1 |



Manopla de silicona

Mouffette en silicone · Fäustling aus Silikon
Silicone mitten · Pegas de silicone

| Ref | € | U.Venta |
|-------|-------|---------|
| 60014 | 10,20 | 6 |



Cubre asas Eco Piedra

Poignées pour plat rond · Griffschutz for Pfanne
Handles for round dish · Asas para paelheira

| Ref | € | Ø (cm) | U.Venta |
|---------|-------|----------|---------|
| R25436A | 11,90 | 32-36-40 | 1 |



Cubre asas Titanium

Poignées · Griffchutz, Silikon
Handles · Asas

| Ref | € | Ø (cm) | U.Venta |
|---------|------|--------|---------|
| R27520A | 4,40 | 20 | 1 |
| R27528A | 4,50 | 24-28 | 1 |
| R27732A | 5,60 | 32-36 | 1 |



Cubre asas Cocotte

Mouffettes en silicone · Griffchutz aus Silikon
Silicone mitten · Pegas de silicone

| Ref | € | Ø (cm) | U.Venta |
|---------|------|----------------|---------|
| R25917G | 8,40 | 16 | 6 |
| R25933G | 8,40 | 20-24-28-26x20 | 6 |
| R25935G | 8,00 | 31x25 | 6 |

Asas Red para plancha grill

Poignées pour plaque à Grill · Griffschutz for Platte Grill
Handles for grill plaque · Asas para plancha Grill

| Ref | € | cm | U.Venta |
|---------|------|----|---------|
| R25536A | 4,10 | 36 | 1 |
| R25547A | 5,70 | 47 | 1 |

Asas Grey para plancha Grill

Poignées pour plaque à Grill · Griffschutz for Platte Grill
Handles for grill plaque · Asas para plancha Grill

| Ref | € | cm | U.Venta |
|---------|------|----|---------|
| R25736A | 4,10 | 36 | 1 |
| R25747A | 5,70 | 47 | 1 |



Paris · Milan · Lima Collection



- Permiten manipular todo tipo de utensilios de cocina con total seguridad.
- Combinan la resistencia al calor con la flexibilidad y comodidad del algodón.
- Guantes con manga que cubre la mayor parte del antebrazo.
- Práctica presilla para colgarlo en la cocina.
- Delantales de gran calidad con bolsillo inferior dividido en dos partes. Unisex. Talla única ajustable.

- Ils permettent de manipuler tous les types d'ustensiles de cuisine en toute sécurité.
- Ils allient la résistance à la chaleur à la souplesse et au confort du coton.
- Gants dont la manche couvre la majeure partie de l'avant-bras.
- Boucle pratique à suspendre dans la cuisine.
- Tabliers de haute qualité avec poche inférieure divisée en deux parties. Unisex. Taille unique réglable.

- For safely handling all types of kitchen utensils.
- Perfectly heat resistant together with the flexibility and comfort of cotton.
- Gloves featuring a sleeve that covers most of the forearm.
- Practical clip for hanging in the kitchen.
- Top-quality aprons featuring a bottom pocket divided into two parts. Unisex. One size fits all (adjustable).



Colección Paris

Collection · Kollektion
Collection · Coleção

| | Ref | € | cm | U.Venta |
|---|-------|-------|-------|---------|
| A | 60080 | 13,90 | 68x83 | 1 |
| B | 60037 | 5,60 | 30 | 1 |
| C | 60044 | 4,40 | 20x20 | 1 |

Colección Milan

Collection · Kollektion
Collection · Coleção

| | Ref | € | cm | U.Venta |
|---|-------|-------|-------|---------|
| A | 60081 | 11,50 | 68x83 | 1 |
| B | 60038 | 5,10 | 30 | 1 |
| C | 60045 | 4,00 | 20x20 | 1 |

Colección Lima

Collection · Kollektion
Collection · Coleção

| | Ref | € | cm | U.Venta |
|---|-------|------|-------|---------|
| A | 60082 | 9,10 | 68x83 | 1 |
| B | 60039 | 4,80 | 30 | 1 |
| C | 60046 | 3,60 | 20x20 | 1 |

Protección PRO

Composición · Composition:
62% Polietileno / 62% Polyethylene
24% Poliéster / 24% Polyester
14% Fibra de vidrio / 14% Glass fiber



Guante protección

Gant de protection · Schutzhandschuh
Protection glove · Luva de protecção

| Ref | € | Talla | Medidas | Perímetro mano | Largo (cm) | U.Venta |
|-------|-------|-------|---------|----------------|------------|---------|
| 61101 | 20,00 | M | 8 | 182 mm | 24 | 1 |
| 61102 | 20,00 | L | 9 | 192 mm | 25 | 1 |
| 61103 | 20,00 | XL | 10 | 204 mm | 26 | 1 |



NO lavable · NOT washable

EN 388:2016+1:2018



344 XC

CE certificate issued by CTC FRANCE

Resistencia a la abrasión 3
Abrasion resistance

Resistencia al corte 4
Blade cut resistance

Resistencia al PDM C
PDM resistance

Resistencia al desgarro 4
Tear resistance

- Ambidiestros, cómodo y ligero.
- **NO emplear con sierras giratorias o dentadas.**

- Ambidextrous, comfortable and light.
- Do NOT use with rotating or toothed saws.



UNE EN 1082

CE Directive 89/686/EEC and EN 1082-1-1996

- **Guante de cinco dedos con correa en la muñeca.**
- **Reversible para mano derecha como izquierda.**
- **Diseño de correa extraíble y protección completa de mano.**
- **Fácil de lavar y desinfectar.**

- Five fingers with a wrist strap.
- Reversible for right hand as left.
- Extractable belt design and full hand protection.
- Easy to wash and disinfect.

Ideal para uso en mandolinas profesionales
Ideal for use in professional mandolins

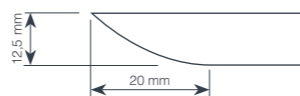

UNE EN 1082

EN ISO 13998: 2003
NIVEL / LEVEL: 2

- **Ajustable gracias a sus tirantes verticales y horizontales.**
- **Conviene asegurarse de que las medidas del cuchillo empleado no sean inferiores a: 20x12,5mm**

- Adjustable thanks to its vertical and horizontal braces.
- It should be ensured that the measures of the knife used are not less than: 20x12.5mm

INOX

Guante Cota

Gant en maille · Netz-Handschuh
Chainmail glove · Luva de malha

| Ref | € | Talla | Medidas | Perímetro mano | Color | U.Venta |
|-------|--------|-------|---------|----------------|------------------|---------|
| 39169 | 142,90 | S | 7 | 171 mm | Blanco · White | 1 |
| 39170 | 142,90 | M | 8 | 182 mm | Rojo · Red | 1 |
| 39171 | 142,90 | L | 9 | 192 mm | Azul · Blue | 1 |
| 39172 | 142,90 | XL | 10 | 204 mm | Naranja · Orange | 1 |

INOX

Delantal cota de malla

Tablier en maille · Kettenhemb Schürze
Metal butcher's apron · Avental de malha

| Ref | € | cm | Perímetro (cm) | U.Venta |
|-------|--------|-------|----------------|---------|
| 39165 | 331,20 | 80x55 | 95-145 | 1 |



Relojes de Cocina



- **Gracias a su parte posterior magnética podrá colocar el reloj de cocina en cualquier parte metálica de su cocina.**
- **Alarma acústica programable.**

- Grâce à sa partie magnétique postérieure, vous pouvez placer l'horloge de cuisine n'importe où dans votre cuisine.
- Alarme acoustique programmable.

- Thanks to its posterior magnetic part you can place the kitchen clock anywhere in your kitchen.
- Programmable acoustic alarm.

IP65

24/12
Horas
Hours



Reloj cocina con alarma

Minuteur de Cuisine avec Alarme · Küchen-Zeitschaltuhr mit Alarm
Kitchen Timer Alarm · Relógio de cozinha com alarme

| Ref | € | cm | U.Venta |
|-------|-------|-------------|---------|
| 60804 | 40,00 | 13x24,5x2,5 | 1 |



Reloj digital

Miniatur Électronique · Digitale Küchen-Zeitschaltuhr mit Alarm
Digital kitchen timer w/alarm · Relógio digital de cozinha com alarme acústico

| Ref | € | cm | Programas | U.Venta |
|-------|------|--------|-----------|---------|
| 60805 | 9,20 | 10,5x7 | 10 | 1 |



Reloj de cocina magnético

Minuteur de cuisine magnétique · Magnetküchentimer
Magnetic kitchen timer · Relógio de cozinha magnetico

| Ref | € | cm | Tiempo | U.Venta |
|-------|-------|---------|--------|---------|
| 60803 | 11,10 | 9,2x3,5 | 60 min | 1 |

24
Horas
Hours



Soporte plegable.
Potente imán
Folding stand.
Powerful magnet

Reloj cocina White

Minuteur de Cuisine avec Alarme · Küchen-Zeitschaltuhr mit Alarm
Kitchen Timer Alarm · Relógio de cozinha com alarme

| Ref | € | cm | U.Venta |
|-------|-------|-----------|---------|
| 60802 | 20,10 | 7x1,4x5,1 | 1 |

U.P Collection

INOX
Dishwasher

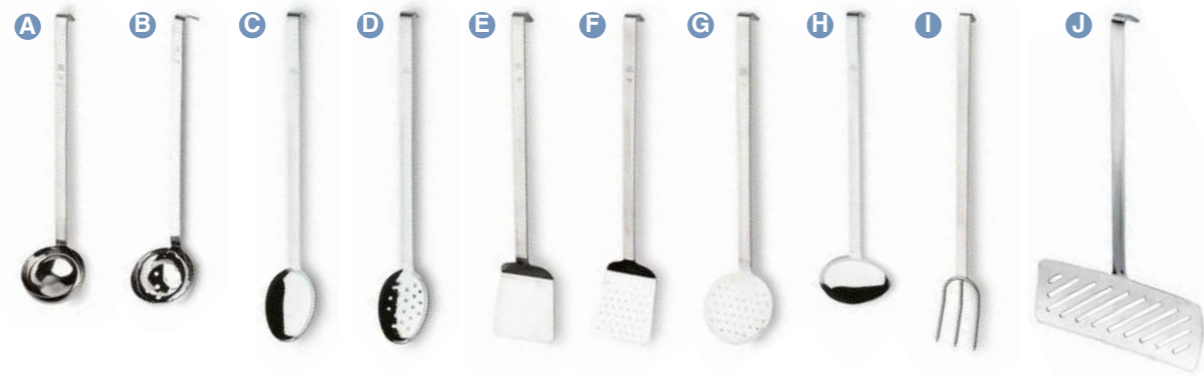

| | Ref | € | Ø (cm) | Largo (cm) | L | U.Venta | |
|---|-------|-------|--------|------------|----------|---------|---|
| A | 60306 | 10,50 | 6,50 | 34,5 | 0,07 | 6 | Cacillo · Louche · Ladle |
| | 60308 | 12,00 | 8,00 | 38,0 | 0,12 | 6 | |
| | 60309 | 12,70 | 9,00 | 46,0 | 0,20 | 6 | |
| | 60310 | 14,40 | 10,00 | 46,0 | 0,25 | 6 | |
| | 60312 | 16,90 | 12,00 | 48,0 | 0,50 | 6 | |
| | 60314 | 21,70 | 14,00 | 55,0 | 0,75 | 6 | |
| B | 60316 | 22,40 | 16,00 | 55,5 | 1,00 | 6 | |
| | 61308 | 11,30 | 8 | 38,0 | 0,12 | 6 | Cacillo perforado · Louche perforée · Perfored ladle |
| | 61310 | 14,60 | 10 | 46,0 | 0,25 | 6 | |
| C | 61312 | 17,40 | 12 | 48,0 | 0,50 | 1 | |
| | 60507 | 11,30 | 10,5 | 48,0 | - | 1 | Cuchara · Cuilliere · Ladle |
| | 60508 | 13,70 | 7,50 | 48,0 | - | 6 | Cuchara perforada · Cuilliere perforee · Perforated ladle |
| D | 61410 | 12,60 | 9x10 | 49,5 | - | 6 | Espátula · Spatule · Spatula |
| | 61412 | 14,30 | 11x12 | 51,0 | - | 6 | |
| E | 61411 | 13,60 | 9x10 | 49,50 | - | 6 | Espátula perforada · Spatule perforee · Perforated spatule |
| | 61413 | 14,80 | 11x12 | 51,0 | - | 6 | |
| | 60408 | 10,00 | 8 | 35,0 | - | 1 | Espumadera · Ecumoire · Skimmer |
| F | 60410 | 12,00 | 10 | 47,0 | - | 6 | |
| | 60412 | 12,60 | 12 | 49,5 | - | 6 | |
| | 60414 | 16,90 | 14 | 57,0 | - | 6 | |
| | 60416 | 18,50 | 16 | 57,0 | - | 6 | |
| G | 60509 | 14,80 | 8x10 | 34,5 | 0,07 | 1 | Cuchara oblicua · Cuilliere oblique · Crosswire spoon |
| | 60002 | 15,80 | 7x8 | 57,5 | 2 puntas | 6 | Tenedor · Fourchette · Fork |
| H | 60003 | 17,60 | 7x13 | 57,5 | 3 puntas | 6 | |
| | 62988 | 20,40 | 20,5x8 | 37,0 | 12 | 12 | Paleta de pescado · Pelle à poisson · Fish turner |



Espumadera alambre Chef Inox

Ecumoire à friture · Fritierlöffel
Skimmer · Escumadeira arame

| Ref | € | Ø (cm) | Largo (cm) | U.Venta |
|-------|-------|--------|------------|---------|
| 60409 | 13,20 | 10 | 47,0 | 6 |
| 60411 | 14,30 | 12 | 49,0 | 6 |
| 60413 | 17,20 | 14 | 50,5 | 6 |
| 60415 | 18,90 | 16 | 52,0 | 6 |
| 60417 | 22,30 | 18 | 58,0 | 6 |
| 60419 | 26,60 | 20 | 59,0 | 6 |
| 60423 | 33,60 | 24 | 71,5 | 6 |
| 60427 | 39,30 | 28 | 74,0 | 6 |

Espumadera alambre

Ecumoire etamee · Fritierschaufel
Tinned skimmer · Escumadeira de arame

| Ref | € | Ø (cm) | Largo (cm) | U.Venta |
|-------|-------|--------|------------|---------|
| 63514 | 12,20 | 14 | 54,0 | 1 |
| 63516 | 13,00 | 16 | 56,5 | 1 |
| 63518 | 13,50 | 18 | 56,5 | 1 |
| 63520 | 16,80 | 20 | 67,0 | 1 |
| 63524 | 18,50 | 24 | 70,5 | 1 |
| 63528 | 21,90 | 28 | 76,0 | 1 |

Alambre estañado · Fil étamé · Tinned wire

Rasera alambre

Araignée à fil · Fritierlöffel
Mesh skimmer · Escumadeira arame

| Ref | € | Ø (cm) | Largo (cm) | U.Venta |
|-------|-------|--------|------------|---------|
| 67410 | 14,30 | 10 | 37,0 | 6 |
| 67412 | 19,40 | 12 | 44,0 | 6 |
| 67415 | 31,10 | 15 | 55,5 | 6 |
| 67417 | 36,30 | 17 | 56,0 | 6 |
| 67420 | 44,50 | 20 | 58,0 | 6 |

Buffet Collection

INOX
18/10
Dishwasher



| | Ref | € | cm | Largo (cm) | U.Venta | |
|---|-------|-------|--------|------------|---------|---|
| A | 72853 | 11,60 | Ø6 | 24,5 | 6 | Cacillo · Louche · Ladle |
| B | 72857 | 10,70 | 5x8 | 27,5 | 6 | Cuchara · Cuilliere · Ladle |
| C | 72858 | 10,70 | 5x8 | 27,5 | 6 | Cuchara perforada · Cuilliere perforee · Perforated ladle |
| D | 72854 | 12,90 | Ø8 | 27,0 | 6 | Espumadera · Ecumoire · Skimmer |
| E | 72859 | 11,60 | 7x9 | 28,5 | 6 | Espátula perforada · Spatule perforee · Perforated spatule |
| F | 72850 | 11,60 | 5x7,5 | 23,5 | 6 | Cacillo salsa · Louche sauce · Gravy ladle |
| G | 72851 | 11,10 | 6x8,5 | 28,0 | 6 | Pala ensalada · Pelle à salade · Dalat scoop |
| H | 72856 | 11,60 | 6,5x11 | 31,5 | 6 | Pala pastel · Pelete à gâteau · Cake scoop |
| I | 72855 | 9,40 | 4,5x9 | 28,5 | 6 | Tenedor · Fourchette · Fork |

Profesional Collection

INOX
18/10
Dishwasher



| | Ref | € | cm | Largo (cm) | U.Venta | |
|---|-------|-------|-------|------------|---------|---|
| A | 72803 | 21,30 | Ø10 | 37,0 | 6 | Cacillo · Louche · Ladle |
| B | 72807 | 15,80 | 7x11 | 36,0 | 6 | Cuchara · Cuilliere · Ladle |
| C | 72808 | 16,10 | 7x11 | 35,5 | 6 | Cuchara perforada · Cuilliere perforee · Perforated ladle |
| D | 72806 | 15,30 | 9x12 | 39,0 | 6 | Espátula · Spatule · Spatula |
| E | 72809 | 17,20 | 9x12 | 39,0 | 6 | Espátula perforada · Spatule perforee · Perforated spatule |
| F | 72804 | 17,70 | Ø11 | 37,0 | 6 | Espumadera · Ecumoire · Skimmer |
| G | 72805 | 14,40 | 3x10 | 35,5 | 6 | Tenedor · Fourchette · Fork |
| H | 72810 | 16,00 | Ø6,5 | 29,0 | 6 | Cacillo salsa · Louche sauce · Gravy ladle |
| I | 72811 | 16,50 | 6,5x9 | 34,0 | 6 | Servidor espaguetis · Cuilliere à spaguetis · Spaguetti server |

Super Monoblock

INOX 18/10
Dishwasher



| | Ref | € | cm | Largo (cm) | U.Venta | |
|---|-------|-------|------|------------|---------|--|
| A | 62603 | 17,30 | Ø10 | 31,0 | 6 | Cacillo · Louche · Ladle |
| B | 62609 | 15,10 | 7x9 | 31,0 | 1 | Cacillo salsa · Louche sauce · Gravy ladle |
| C | 62607 | 12,90 | 7x10 | 32,0 | 6 | Cuchara · Cuillère · Ladle |
| D | 62608 | 12,10 | 7x10 | 32,0 | 1 | Cuchara perforada · Cuillère perforee · Perforated ladle |
| E | 62604 | 17,30 | Ø11 | 36,5 | 6 | Espumadera · Ecumoire · Skimmer |
| F | 62606 | 12,60 | 8x9 | 33,5 | 6 | Espátula · Spatule · Spatula |
| G | 62605 | 11,00 | 3x8 | 33,5 | 1 | Tenedor · Fourchette · Fork |
| H | 62811 | 14,40 | Ø7,5 | 31,0 | 6 | Servidor espaguetis · Cuillère à spaguetis · Spaguetti server |
| I | 62601 | 92,60 | - | - | 1 | Juego 5 piezas · 5 utensiles de cuisine · 5 pds. kichen tools |
| J | 62630 | 24,60 | 40 | - | 1 | Soporte juego · Soutien · Hanging rack |



Cacillo (62603)
Espumadera (62604)
Tenedor (62605)
Espátula (62606)
Cuchara lisa (62607)

Monoblock Collection

INOX 18/10
Dishwasher



| | Ref | € | cm | Largo (cm) | U.Venta | |
|---|-------|------|--------|------------|---------|--|
| A | 62503 | 8,40 | Ø9 | 31,5 | 1 | Cacillo · Louche · Ladle |
| B | 62507 | 6,80 | 6,5x10 | 34,5 | 1 | Cuchara · Cuillère · Ladle |
| C | 62504 | 8,50 | Ø11,5 | 35,0 | 1 | Espumadera · Ecumoire · Skimmer |
| D | 62506 | 6,60 | 8x10 | 35,5 | 1 | Espátula · Spatule · Spatula |
| E | 62505 | 5,70 | 2,5x10 | 33,5 | 1 | Tenedor · Fourchette · Fork |



DUE Collection

PA INOX SI
Nylon 18/10 Silicone Dishwasher BPA free

- **Colección de utensilios de nylon, ofrece un diseño versátil y cómodo.**
 - **Mangos fabricados en acero inoxidable 18/10 de gran calidad y resistencia.**
 - **Utensilios antiadherentes y flexibles.**
 - **Soporta fuertes cambios de temperatura.**
 - **Libres de BPA.**
- Collection d'ustensiles en nylon, offrant un design polyvalent et confortable.
 - Poignées en acier inoxydable 18/10 de haute qualité et résistant.
 - Ustensiles antiadhésifs et flexibles.
 - Résiste aux fortes variations de température.
 - Sans BPA.
- Nylon utensils collection, offering a versatile and comfortable versatile and comfortable design.
 - Handles made of high quality and resistant 18/10 stainless steel.
 - Non-stick and flexible utensils.
 - Withstands strong temperature changes.
 - BPA free



| | Ref | € | cm | Largo (cm) | U.Venta | |
|---|-------|------|-----------|------------|---------|--|
| A | 68270 | 8,60 | 7x10,5 | 36,5 | 6 | Cuchara · Cuillère · Ladle |
| B | 68271 | 8,80 | 10,5x9,5 | 33,5 | 6 | Cacillo · Louche · Ladle |
| C | 68272 | 8,60 | 10,5x10,5 | 36,5 | 6 | Espumadera · Ecumoire · Skimmer |
| D | 68274 | 8,80 | 8,5x10,5 | 37,5 | 6 | Espátula · Spatule · Spatula |
| E | 68275 | 8,70 | 8,5x10,5 | 37,5 | 6 | Espátula perforada · Spatule perforee · Perforated spatule |
| F | 68273 | 8,30 | 6,5x9,5 | 36,5 | 6 | Servidor espaguetis · Cuillère à spaguetis · Spaguetti server |
| G | 68276 | 8,80 | 8x14,5 | 36,5 | 6 | Paleta de pescado · Pelle à poisson · Fish turner |

Black Collection

PA Nylon Dishwasher BPA free



| | Ref | € | cm | Largo (cm) | U.Venta |
|---|-------|------|--------|------------|---------|
| A | 98903 | 3,90 | 8x9,5 | 31,0 | 12 |
| B | 98907 | 3,90 | 6,5x10 | 30,0 | 12 |
| C | 98908 | 3,90 | 6,5x9 | 30,0 | 12 |
| D | 98905 | 3,90 | 7,5x9 | 25,0 | 12 |
| E | 98906 | 3,90 | 9x10 | 31,0 | 12 |
| F | 98912 | 3,90 | 8x12 | 28,0 | 12 |
| G | 98913 | 3,90 | 4x7 | 31,0 | 12 |
| H | 98904 | 3,90 | Ø11 | 33,0 | 12 |
| I | 98910 | 3,90 | 6x8,5 | 27,0 | 12 |
| J | 98911 | 3,90 | 6x8 | 30,0 | 12 |
| K | 98909 | 3,90 | 8x16 | 32,0 | 12 |
| L | 98914 | 3,90 | 7x7 | 30,0 | 12 |

Cacillo · Louche · Ladle
Cuchara · Cuillère · Ladle
Cuchara perforada · Cuillère perforee · Perforated ladle
Cuchara salsa · Cuillère sauce · Gravy spoon
Espátula perforada · Spatule perforee · Perforated spatule
Espátula corta · Spatule court · Short spatule
Espátula larga · Spatule longue · Long spatule
Espumadera · Ecumoire · Skimmer
Cacillo salsa · Louche sauce · Gravy ladle
Servidor espaguetis · Cuillère à spaguetis · Spaguetti server
Paleta de pescado · Pelle à poison · Fish turner
Batidor · Fouet · Whisk

ECO Collection

PA Nylon Dishwasher BPA free



| | Ref | € | cm | Largo (cm) | U.Venta |
|---|-------|------|--------|------------|---------|
| A | 98803 | 5,20 | Ø9,5 | 29,0 | 12 |
| B | 98807 | 4,40 | 7,5x10 | 30,5 | 12 |
| C | 98808 | 4,10 | 7,5x10 | 30,5 | 12 |
| D | 98804 | 4,90 | Ø11 | 31,5 | 12 |
| E | 98806 | 4,50 | 8x10 | 33,0 | 12 |
| F | 98810 | 3,90 | 8x6,5 | 27,0 | 12 |
| G | 98811 | 4,00 | Ø7,5 | 29,0 | 12 |

Cacillo · Louche · Ladle
Cuchara · Cuillère · Ladle
Cuchara perforada · Cuillère perforee · Perforated ladle
Espumadera · Ecumoire · Skimmer
Espátula perforada · Spatule perforee · Perforated spatule
Cacillo salsa · Louche sauce · Gravy ladle
Servidor espaguetis · Cuillère à spaguetis · Spaguetti server

Aqua Garinox Collection

PP Polypropylene Dishwasher BPA free



garinox®

| | Ref | € | cm | U.Venta |
|---|-------|------|------|---------|
| A | 64480 | 2,30 | 32,5 | 1 |
| B | 64481 | 2,30 | 33,5 | 1 |
| C | 64482 | 2,30 | 32,5 | 1 |
| D | 64483 | 2,30 | 32,5 | 1 |
| E | 64484 | 2,30 | 29,5 | 1 |

Cacillo · Louche · Ladle
Espumadera · Ecumoire · Skimmer
Espátula perforada · Spatule perforee · Perforated spatule
Cuchara · Cuillère · Ladle
Servidor espaguetis · Cuillère à spaguetis · Spaguetti server



Grey Collection



Núcleo reforzado para una mayor resistencia sin perder flexibilidad en los bordes.
Diseñados en una sola pieza, sin costuras ni grietas
 Reinforced core improves strength without losing flexibility around the edges.
 Designed in a single piece without seams or cracks



| | Ref | € | cm | Largo (cm) | U.Venta | |
|---|-------|------|---------|------------|---------|--|
| A | 64466 | 7,90 | Ø9,5 | 29,0 | 1 | Cacillo · Louche · Ladle |
| B | 64469 | 7,00 | 5,6x9,5 | 29,0 | 1 | Cuchara · Cuillère · Ladle |
| C | 64467 | 7,90 | Ø9 | 29,0 | 1 | Espumadera · Ecumoire · Skimmer |
| D | 64468 | 7,00 | 7,5x9,5 | 29,0 | 1 | Espátula perforada · Spatule perforée · Perforated spatule |
| E | 64470 | 7,70 | 5,5x9,5 | 27,0 | 1 | Servidor espaguetis · Cuillère à spaguëtis · Spaguëtti server |
| F | 64471 | 7,00 | 4x12,5 | 27,0 | 1 | Espátula estrecha · Spatule étroite · Narrow spatule |
| G | 64462 | 7,90 | - | 29,0 | 1 | Pinza larga · Pince longue · Long tong |
| H | 64463 | 5,60 | - | 27,5 | 1 | Cuchara · Cuillère · Ladle |
| I | 64464 | 5,60 | 5,5x8 | 27,5 | 1 | Espátula · Spatule · Spatula |
| J | 64465 | 5,70 | - | 27,5 | 1 | Pincel · Pinceau · Brush |

Brun Collection



Fabricadas en madera de haya natural de alta calidad, acabadas con aceites naturales
 Made from natural beech wood of high quality and finished with natural oils



| | Ref | € | cm | Largo (cm) | U.Venta | |
|---|-------|------|--------|------------|---------|---|
| A | 68175 | 6,20 | 6x10 | 30,0 | 6 | Cuchara · Cuillère · Ladle |
| B | 68176 | 6,50 | 7x10 | 30,0 | 6 | Cuchara perforada · Cuillère perforée · Perforated ladle |
| C | 68177 | 6,20 | 6,5x10 | 30,0 | 6 | Espátula · Spatule · Spatula |
| D | 68178 | 6,40 | 7,5x12 | 30,0 | 6 | Espátula perforada · Spatule perforée · Perforated spatule |
| E | 68179 | 6,70 | 6,5x10 | 30,0 | 6 | Cuchara especial · Cuillère spéciale · Special spoon |
| F | 68173 | 7,20 | 8x7 | 30,0 | 6 | Cuchara ensalada · Cuillère à salade · Salad spoon |
| G | 68174 | 7,20 | 8x7 | 30,0 | 6 | Tenedor ensalada · Fourchette à salade · Salad fork |

Nordic Collection



Cabezal fabricado en nylon, resistente y duradero, libre de BPA. Mango ergonómico de madera de haya 100% natural
 Head made of nylon. Strong and long lasting. BPA free. Ergonomic natural beech wood handle.



| | Ref | € | cm | Largo (cm) | U.Venta | |
|---|-------|------|------|------------|---------|--|
| A | 68280 | 4,90 | Ø9 | 32,0 | 1 | Cacillo · Louche · Ladle |
| B | 68281 | 4,90 | 6,2 | 34,0 | 1 | Cuchara · Cuillère · Ladle |
| C | 68282 | 4,90 | 8,4 | 35,3 | 1 | Espátula perforada · Spatule perforée · Perforated spatule |
| D | 68283 | 4,90 | 11,2 | 34,3 | 1 | Espumadera · Ecumoire · Skimmer |
| E | 68284 | 4,90 | 6,5 | 34,0 | 1 | Servidor espaguetis · Cuillère à spaguëtis · Spaguëtti server |

Unite Collection



| | Ref | € | cm | Largo (cm) | U.Venta | |
|---|-------|------|----------|------------|---------|--|
| A | 68187 | 6,90 | Ø8 | 31,5 | 1 | Cacillo · Louche · Ladle |
| B | 68185 | 6,00 | 6,7x10,5 | 32 | 1 | Cuchara · Cuillère · Ladle |
| C | 68195 | 4,40 | 5,6x8,5 | 26,5 | 1 | Espátula · Spatule · Spatula |
| D | 68186 | 6,10 | 7,5x10,5 | 33,5 | 1 | Espátula perforada · Spatule perforée · Perforated spatule |
| E | 68188 | 7,00 | Ø11,5 | 33,5 | 1 | Espumadera · Ecumoire · Skimmer |
| F | 68189 | 6,10 | 5,5x9,5 | 32,5 | 1 | Servidor espaguetis · Cuillère à spaguëtis · Spaguëtti server |
| G | 68196 | 4,20 | 5,5x0,5 | 24,5 | 1 | Pincel · Pinceau · Brush |
| H | 68197 | 4,30 | - | 14,5 | 1 | Pelador liso · Éplucheuse plate · Peeler plain blade |
| I | 68198 | 4,30 | - | 14,5 | 1 | Pelador dentado · Éplucheuse dentelé · Serrated peeler |
| J | 68199 | 6,10 | - | 27,0 | 1 | Batidor · Fouet · Whisk |

BBQ Collection

INOX 
Dishwasher

- **Práctico maletín de aluminio compuesto por 5 utensilios para barbacoa: espátula, tenedor, cuchillo, pinza dentada y brocha.**
- **Todas las piezas fabricadas en acero inoxidable de máxima calidad.**
- **Mango ergonómico, resistente al calor.**
- **Completa el set con los accesorios adicionales: espátula acodada y cepillo de limpieza.**

- Malette pratique en aluminium composée de 5 ustensiles pour barbecue : spatule, fourchette, couteau, pince dentée et broche.
- Toutes les pièces sont fabriquées en acier inoxydable de la plus grande qualité.
- Manche ergonomique, résistant à la chaleur.
- Complétez l'ensemble avec les accessoires supplémentaires : spatule coudée et brosse de nettoyage.

- Practical aluminium case with 5 barbecue utensils: spatula, fork, knife, serrated tongs and brush.
- All parts made of top-quality stainless steel.
- Ergonomic, heat-resistant handle.
- Complete the set with these additional accessories: angled spatula and cleaning brush.



Maletín
Malette · Koffer
Briefcase · Maleta

| Ref | € | cm | U.Venta |
|-------|-------|-----------|---------|
| 60260 | 48,00 | 47x16,6x8 | 1 |

Tenedor
Fourchette · Tranchiergabel
Fork · Garfo

| Ref | € | Largo (cm) | U.Venta |
|-------|------|------------|---------|
| 60261 | 5,20 | 43,5 | 1 |

Cuchillo
Couteau · Messer
Knife · Faca

| Ref | € | Largo (cm) | U.Venta |
|-------|------|------------|---------|
| 60262 | 5,00 | 41,5 | 1 |



Espátula
Spatule · Schaufel
Spatule · Espátula

| Ref | € | Largo (cm) | U.Venta |
|-------|------|------------|---------|
| 60263 | 8,30 | 45,5 | 1 |

Brocha
Broche · Bürstes
Brush · Escova

| Ref | € | Largo (cm) | U.Venta |
|-------|------|------------|---------|
| 60264 | 6,30 | 44,0 | 1 |



Pinza
Pincs · Zange
Tong · Pinça

| Ref | € | Largo (cm) | U.Venta |
|-------|-------|------------|---------|
| 60265 | 10,20 | 43,5 | 1 |



Accesorios · Accessoires · Accessories

Espátula acodada
Spatule coudées · Winkelpalette
Bent spatule · Espátula comprida

| Ref | € | Largo (cm) | U.Venta |
|-------|------|------------|---------|
| 60266 | 6,00 | 28,0 | 1 |



Cepillo de limpieza
Brosse de nettoyage · Reinigungsbürste
Cleaning brush · Escova de limpeza

| Ref | € | Largo (cm) | U.Venta |
|-------|------|------------|---------|
| 60267 | 7,00 | 45,0 | 1 |



BBQ Nordic Collection

INOX 

- **Fabricadas en acero inoxidable de gran calidad.**
- **Mango de madera de caucho con un acabado barnizado.**
- **Agarre cómodo y firme.**
- **Práctica cuerda de cuero para colgar.**

- Fabriquées en acier inoxydable de haute qualité.
- Manche en bois de caoutchouc verni.
- Préhension confortable et ferme.
- Elle dispose d'un cordon en cuir pour la suspendre.

- Made of high quality stainless steel.
- Rubberwood handle with a varnished finish.
- Easy and firm grip.
- It has a leather cord for hanging.



Espátula acodada
Spatule coudée · Gewinkelter Spachtel
Angled spatula · Espátula angular

| | Ref | € | Largo (cm) | U.Venta |
|---|-------|------|------------|---------|
| A | 60268 | 4,80 | 30,5 | 1 |
| B | 60269 | 5,20 | 34,0 | 1 |

Set de 3 utensilios
Set de 3 ustensiles · Satz mit 3 Utensilien
Set of 3 utensils · Conjunto de 3 utensílios

| | Ref | € | Largo (cm) | U.Venta |
|--|-------|-------|------------|---------|
| | 60270 | 14,70 | 47,6 | 1 |
| | | | 47,0 | |
| | | | 40,0 | |

Cacillo Select

INOX 

- **Fabricados en acero inoxidable de gran calidad.**
- **Gran resistencia y durabilidad, diseñados para un uso intensivo.**
- **Mango revestido de PVC aislante que permite un agarre cómodo y antideslizante.**
- **Disponibles en distintos colores.**

- Fabriqué en acier inoxydable de haute qualité.
- Très résistant et durable, conçu pour un usage intensif.
- Poignée recouverte de PVC isolant pour une prise en main confortable et antidérapante.
- Disponible en différentes couleurs.

- Made of high quality stainless steel.
- Highly resistant and durable, designed for intensive use.
- Handle coated with insulating PVC for a comfortable non-slip grip.
- Available in different colours.

Cacillo Select
Louche · Schöpfkelle
Ladle · Colher

| Ref | € | Ø (cm) | h(cm) | ml | U.Venta |
|-------|------|--------|-------|--------|---------|
| 60655 | 4,10 | 5,00 | 25,50 | 29,50 | 1 |
| 60656 | 4,20 | 6,00 | 26,00 | 60,00 | 1 |
| 60657 | 4,40 | 7,00 | 27,00 | 89,00 | 1 |
| 60658 | 4,70 | 8,00 | 34,50 | 118,00 | 1 |
| 60659 | 5,40 | 8,50 | 34,50 | 148,00 | 1 |



Utensilios Varios

INOX
18/10
Dishwasher



Sección cuadrada
(2,5x2,5 mm)
Square section



Pincho moruno 6u

Brochette carre en inox. (6) · Fleischspiesse (6), Rostfrei
St. steel skewers square wire (6) · Espeto moruno Inóx (6)

| Ref | € | Largo (cm) | U.Venta |
|---------|------|------------|---------|
| * 62446 | 5,00 | 20,0 | 12 |
| 62435 | 5,70 | 30,5 | 12 |
| 62445 | 6,80 | 40,5 | 12 |

* Apto para las freidoras de aire · Suitable for air fryers



Cuchara apoya utensilios

Cuillère ramasse ustensiles · Vorlegelöffel
Spoon holder utensils · Colher recolhe utensilios

| Ref | € | cm | Largo (cm) | U.Venta |
|-------|-------|-------|------------|---------|
| 62972 | 11,80 | 25x12 | 25 | 1 |



AL
Aluminium

Barra sujeción notas

Barre à notes · Zettelhalter
Order rall · Barra fixação notas

| Ref | € | Largo (cm) | U.Venta |
|-------|-------|------------|---------|
| 60731 | 12,00 | 30,50 | 1 |
| 60746 | 15,60 | 46,00 | 1 |
| 60761 | 18,70 | 61,00 | 1 |
| 60776 | 21,60 | 76,00 | 1 |
| 60791 | 26,80 | 91,50 | 1 |



6 ganchos carnicero

6 crochets de boucher · 6-Tlg Metzgerhaken
6 butchers hook · 6 ganchos de carnicero

| Ref | € | Puntas | Ø (mm) | Largo (cm) | U.Venta |
|---------|-------|--------|--------|------------|---------|
| A 39043 | 12,00 | 1 | 5 | 12,5 | 4 |
| 39044 | 18,60 | 1 | 5 | 18,5 | 1 |
| B 39047 | 12,10 | 2 | 5 | 12,5 | 4 |
| 39048 | 18,80 | 2 | 5 | 18,5 | 1 |



INOX



Contenedor cubiertos

Panier à couverts · Besteckköcher
Cutlery holder · Copos para talheres

| Ref | € | Ø (cm) | h(cm) | L | U.Venta |
|-------|-------|--------|-------|------|---------|
| 62962 | 21,60 | 12 | 13,6 | 1,40 | 1 |
| 62963 | 25,10 | 12 | 18,7 | 2,00 | 1 |



Colgador de barra

Penderie murale · Hängeleiste
Wall hanger · Suporte de barra

| Ref | € | Unidades | Largo (cm) | U.Venta |
|---------|-------|----------|------------|---------|
| 60740 | 23,10 | 6 | 40 | 1 |
| 60760 | 31,90 | 8 | 60 | 1 |
| 60710 | 44,10 | 12 | 100 | 1 |
| A 60700 | 6,90 | 6 | - | 12 |

Juego 6 ganchos
Ensemble 6 crochets
6 hook set

Preparación
Food processing

Espátulas

INOX
Dishwasher



Espátula de pescado Flex
Spatule flexible à poisson · Fisch Schaufel, flexible
Flexible spatula to fish · Espátula flexível para peixe

| Ref | € | Largo (cm) | U.Venta |
|-------|------|------------|---------|
| 60426 | 4,50 | 30 | 6 |



INOX 18/10
Silicone
BPA free

Espátula de pescado Pro
Spatule à poisson · Fischheber
Fish spatula · Espátula de peixe

| Ref | € | Largo (cm) | U.Venta |
|-------|-------|------------|---------|
| 60726 | 14,00 | 30 | 1 |



Espátula serrada
Spatule à gâteau · Backschaufel
Serrated spatula · Espátula com serrilha

| Ref | € | cm | U.Venta |
|-------|------|--------|---------|
| 62677 | 9,00 | 30x5,5 | 6 |



Espátula grill
Spatule coudée our grill · Winkelpalette
Bent grillspatula · Espátula comprida grelha

| Ref | € | cm | U.Venta |
|-------|------|-------|---------|
| 60434 | 6,10 | 12x27 | 6 |



Paleta triangular
Grattoir manche noir m/solide · Bratenspachtel, Stiel
Straight Scraper/turner · Espátula triangular cabo sólido

| Ref | € | cm | U.Venta |
|-------|------|---------|---------|
| 60430 | 7,00 | 10x11,5 | 12 |



Espátula lisa Bent
Spatule lisse m/solide · Backschaufel, f. Feststoffe
Straight spatula · Espátula lisa cabo sólido

| Ref | € | cm | U.Venta |
|-------|------|--------|---------|
| 60425 | 4,90 | 7x13,5 | 12 |

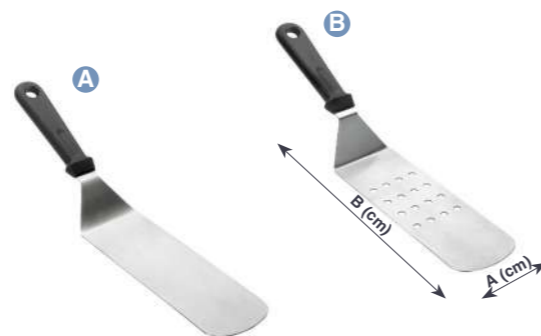

Espátula repostería
Pâtisserie spatule · Gebackpalette
Pastry spatula · Espátula pastelaria

| Ref | € | cm | U.Venta |
|-------|------|----------|---------|
| 60443 | 4,10 | 6,5x14,5 | 12 |

Espátula para emplatar
Mini spatule coudée · Winkelpalette Mini
Mini bent spatula · Espátula mini comprida

| Ref | € | cm | U.Venta |
|-------|------|-----|---------|
| 60442 | 3,80 | 2x9 | 12 |

Espátula lisa Black
Spatule lisse m/solide · Spachtel, mit solidem Stiel
Straight spatula · Espátula lisa cabo sólido

| Ref | € | AxB (cm) | U.Venta |
|---------|------|----------|---------|
| A 60420 | 5,40 | 7,5x21,5 | 12 |
| B 60421 | 5,30 | 7,5x21,5 | 12 |



2 in 1
Cortar · Cut
Servir · Serve up

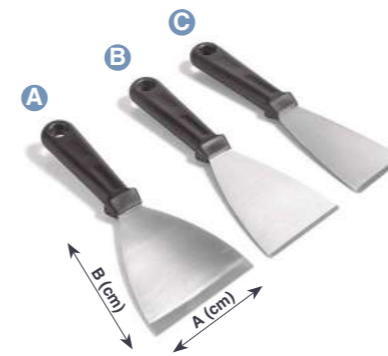

Espátula para plancha
Spatule m/solide · Grillspachtel, mit solidem Stiel
Straight spatula · Espátula grelha cabo sólido

| Ref | € | A (cm) | B (cm) | U.Venta |
|---------|------|--------|--------|---------|
| A 60422 | 4,70 | 10 | 11,5 | 12 |
| B 60445 | 4,00 | 8 | 11,5 | 12 |
| C 60446 | 3,90 | 6 | 11,5 | 12 |



Espátula lisa Ring
Spatule manche noir · Schaufel mit schwarzem Stiel
Solid turner w/black H. · Espátula cabo negro

| Ref | € | AxB (cm) | Largo (cm) | U.Venta |
|---------|------|----------|------------|---------|
| A 60435 | 7,80 | 7,5x17 | 35 | 6 |
| B 60438 | 7,90 | 7,5x17 | 35 | 6 |



Espátula acodada
Spatule coudée · Winkelpalette
Bent spatula · Espátula comprida

| Ref | € | cm | U.Venta |
|-------|------|------|---------|
| 60482 | 4,00 | 4x15 | 12 |
| 60483 | 4,30 | 4x19 | 12 |
| 60484 | 4,60 | 4x24 | 12 |



Espátula larga acodada
Spatule longue coudée m/solide · Winkelpalette, lang
Long bent spatula · Espátula comprida c/cabo sólido

| Ref | € | Largo (cm) | U.Venta |
|-------|------|------------|---------|
| 60467 | 4,00 | 20 | 12 |
| 60468 | 4,10 | 25 | 12 |
| 60469 | 4,20 | 30 | 12 |



Espátula larga recta
Spatule longue droite m/solide · Palette, lang, gerade
Long straight spatula · Espátula comprida c/cabo sólido

| Ref | € | Largo (cm) | U.Venta |
|-------|------|------------|---------|
| 60461 | 3,80 | 15 | 12 |
| 60462 | 3,90 | 20 | 12 |
| 60463 | 4,00 | 25 | 12 |
| 60464 | 4,10 | 30 | 12 |
| 60465 | 4,20 | 35 | 12 |



INOX 18/10

Espátula gigante Inox
Spatule geante en Inox · Rührspatel, Edelstahl
St steel long handle Turner · Espátula gigante Inóx

| Ref | € | Largo (cm) | U.Venta |
|-------|-------|------------|---------|
| 61481 | 68,40 | 80 | 1 |
| 61421 | 74,80 | 120 | 1 |

PE
Polyethilene

Pala profesional
Pelle professionnelle · Professionelle Ruhrspatel
Professional shovel · Pá professional

| Ref | € | Largo (cm) | U.Venta |
|-------|-------|------------|---------|
| 60404 | 79,30 | 81,5 | 1 |



- Pala profesional fabricada en acero inoxidable de gran calidad.
- Diseño trapezoidal para recoger y embolsar patatas fritas en fracciones individuales de forma rápida.
- Multifuncional: también se puede usar para servir palomitas de maíz, nueces, hielo o dulces.
- 1 o 2 mangos ergonómicos y antideslizantes para usuarios zurdos y diestros.
- Fácil de limpiar. Apta para el lavavajillas.

- Pelle professionnelle en acier inoxydable de haute qualité.
- Conception trapézoïdale pour collecter et embolser rapidement les pommes de terre frites dans des fractions individuelles.
- Multifonctionnel: il peut également être utilisé pour servir le maïs, les noix, la glace ou les bonbons.
- 1 ou 2 manguers ergonomiques et non glissantes pour les utilisateurs de gauche et de droite.
- Facile à nettoyer. Convient au lave-vaisselle.

Pala para patatas

Pelle à pommes de terre · Kartoffelschaufel
Potato shovel · Pá de batatas

| | Ref | € | cm | Nº Asas | U.Venta |
|---|-------|-------|-------|---------|---------|
| A | 62678 | 12,90 | 20x22 | 1 | 1 |
| B | 62679 | 15,20 | 20x22 | 2 | 1 |

Espátulas de silicona



FE
Iron

Utensilios Grey

Ustensiles en silicone · Silikonutensilien
Silicone utensils · Utensilios de silicone

| | Ref | € | Largo (cm) | U.Venta |
|---|-------|------|------------|---------|
| A | 64463 | 5,60 | 27,5 | 1 |
| B | 64464 | 5,60 | 27,5 | 1 |
| C | 64465 | 5,70 | 27,5 | 1 |

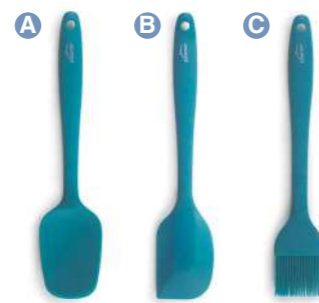

FE
Iron

Utensilios Ocean

Ustensiles en silicone · Silikonutensilien
Silicone utensils · Utensilios de silicone

| | Ref | € | Largo (cm) | U.Venta |
|-----|-------|-------|------------|---------|
| Set | 64452 | 17,20 | 27,5 | 1 |
| A | 64453 | 6,00 | 27,5 | 1 |
| B | 64454 | 6,00 | 27,5 | 1 |
| C | 64455 | 6,00 | 27,5 | 1 |



Mango ABS · ABS handle

Espátula Comfort

Spatule en silicone · Teigschaber
Silicone spatula · Espátula de silicone

| | Ref | € | Largo (cm) | U.Venta |
|---|-------|------|------------|---------|
| A | 64444 | 6,10 | 28 | 1 |
| B | 64445 | 6,80 | 30 | 1 |
| C | 64446 | 6,90 | 31 | 1 |



Espátula White

Spatule en silicone · Teigschaber
Silicone spatula · Espátula de silicone

| | Ref | € | Largo (cm) | U.Venta |
|--|-------|-------|------------|---------|
| | 67421 | 4,70 | 20 | 1 |
| | 67427 | 7,00 | 26 | 1 |
| | 67433 | 15,30 | 32 | 1 |



Espátula Grey

Spatule en silicone · Teigschaber
Silicone spatula · Espátula de silicone

| | Ref | € | Largo (cm) | U.Venta |
|--|-------|------|------------|---------|
| | 67434 | 4,80 | 30 | 12 |
| | 67435 | 5,60 | 29 | 12 |



Espátula Unite

Spatule · Backschauffel
Spatule · Espátula

| | Ref | € | cm | Largo (cm) | U.Venta |
|--|-------|------|---------|------------|---------|
| | 68195 | 4,40 | 5,6x8,5 | 26,5 | 1 |

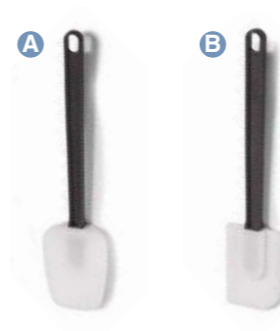

Espátula silicona

Spatule en silicone · Teigschaber
Silicone spatula · Espátula de silicone

| | Ref | € | Largo (cm) | U.Venta |
|---|-------|-------|------------|---------|
| A | 64450 | 5,70 | 25 | 6 |
| | 64451 | 9,10 | 35 | 6 |
| | 64460 | 6,00 | 25 | 6 |
| B | 64461 | 10,00 | 35 | 6 |



Espátula para tarros

Spatule pour pots · Spatel für Einmachgläser
Jar spatula · Espátula para frascos

| | Ref | € | cm | Largo (cm) | U.Venta |
|--|-------|------|----------|------------|---------|
| | 64490 | 2,50 | 3,8x8,4 | 25 | 1 |
| | 64491 | 4,10 | 4,8x10,8 | 35 | 1 |

Espátula profesional ExtraPlana

Spatula professionnelle · Profi-Spachtel
Professional spatula · Espátula profesional

| | Ref | € | Largo (cm) | U.Venta |
|--|-------|------|------------|---------|
| | 61373 | 5,60 | 30 | 1 |
| | 61375 | 6,20 | 35 | 1 |
| | 61374 | 7,50 | 40 | 1 |

Set repostería- 20 pcs.

Exposant pâtisserie · Aufsteller Pastry
Pastry display · Expositor pastelería

| | Ref | € | Largo (cm) | Piezas | U.Venta |
|---|-------|-------|------------|--------------------------------|---------|
| | 64424 | 80,40 | - | Caja (20 pcs.) · Set (20 pcs.) | 1 |
| A | 64426 | 4,10 | 23,0 | Pincel · Brush | 12 |
| B | 64427 | 4,10 | 23,0 | Espátula · Spatula | 12 |
| C | 64428 | 4,10 | 23,0 | Lengua gato · Spatula | 12 |
| D | 64429 | 4,10 | 23,0 | Batidor · Whisk | 12 |

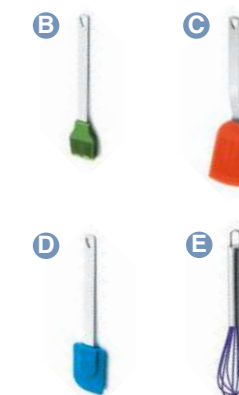

Rasquetas



Rasqueta

Coupe pate · Schaber
Scraper · Raspador

| | Ref | € | cm | U.Venta |
|--|-------|-------|---------|---------|
| | 67041 | 25,80 | 13,8x13 | 1 |

Diseño apilable
Stackable design



Rasqueta Flex

Coupe pate · Schaber
Scraper · Raspador

| | Ref | € | cm | U.Venta |
|--|-------|------|------|---------|
| | 67414 | 9,10 | 9x15 | 1 |



Rasqueta Inox
Coupe pate · Schaber
Scraper · Raspador

| | Ref | € | cm | U.Venta |
|---|-------|-------|------|---------|
| A | 67005 | 13,20 | 15x9 | 6 |
| B | 67006 | 12,70 | 15x9 | 6 |



INOX
18/10

Rasqueta Inox Black
Coupe pate · Schaber
Scraper · Raspador

| Ref | € | cm | U.Venta |
|-------|------|-----------|---------|
| 67029 | 9,70 | 16,5x10,5 | 6 |

Pizza Collection

INOX
Oven



Cacillo salsa
Louche sauce · Saucengliesslöffel
Gravy ladle · Concha para molho

| Ref | € | Ø (cm) | Largo (cm) | Capacidad | U.Venta |
|-------|------|--------|------------|-----------|---------|
| 60562 | 5,70 | 7 | 27,0 | 80 g | 1 |



Soporte para hornear pizzas
Support avec plaques à pizzas · Pizza Backblech
Pizza baking rack · Suporte para cozer pizzas no forno

| Ref | € | Bandejas | Ø (cm) | h(cm) | U.Venta |
|-------|-------|----------|--------|-------|---------|
| 61462 | 24,90 | 4 | 29,5 | 21 | 1 |



INOX
18/10

Espátula pizza
Spatule pizza · Pizzaspatel
Pizza spatula · Espátula pizza

| Ref | € | cm | U.Venta |
|-------|-------|-------------|---------|
| 60424 | 14,20 | 16,5x17,5x5 | 1 |



INOX
18/10

Pala Pizza
Pelle pizza · Pizzaschaufel, flach
Pizza flat scoop · Espátula pizza

| Ref | € | cm | U.Venta |
|-------|-------|-------|---------|
| 61461 | 14,40 | 25x36 | 1 |



Pala pizza Lungo
Pelle pizza · Pizzaofen-Schaufel
Pizza oven scoop · Pá de pizza

| Ref | € | Largo (cm) | U.Venta |
|-------|--------|------------|---------|
| 61460 | 105,70 | 160 | 1 |

Mango es desmontable
handle is removable



Pala pizza Wood
Pelle pizza · Pizzaofen-Schaufel
Pizza oven scoop · Pá de pizza

| Ref | € | cm | Largo (cm) | U.Venta |
|-------|-------|-----------|------------|---------|
| 61463 | 23,20 | 30,5x35,5 | 88 | 1 |



Cortapizza PRO
Roulette pizza · Pizzaschneider
Pizza cutter · Corta-Pizza

| Ref | € | Largo (cm) | U.Venta |
|-------|------|------------|---------|
| 61465 | 7,70 | 35 | 1 |



Cortapizza Basic
Roulette pizza · Pizzaschneider
Pizza cutter · Corta-Pizza

| Ref | € | Ø (cm) | U.Venta |
|-------|------|--------|---------|
| 60429 | 5,10 | 10 | 12 |



Cortapizza Luxe
Roulette pizza · Pizzaschneider
Pizza cutter · Corta-Pizza

| Ref | € | Ø (cm) | U.Venta |
|-------|-------|--------|---------|
| 67004 | 18,00 | 10 | 1 |



Cortapizza Plus
Roulette pizza · Pizzaschneider
Pizza cutter · Corta-Pizza

| Ref | € | Ø (cm) | U.Venta |
|-------|-------|--------|---------|
| 67028 | 12,40 | 10 | 1 |



INOX
18/10

Cortapizza Ergonomic
Roulette pizza · Pizzaschneider
Pizza cutter · Corta-Pizza

| Ref | € | Ø (cm) | U.Venta |
|-------|------|--------|---------|
| 67027 | 6,00 | 8 | 6 |





Batidores

INOX 18/10
Dishwasher

INOX

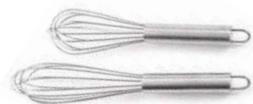

Batidor mini

Mini fouet inox · Mini-Schneebeesen
Mini whisk · Mini batedor Inóx

| Ref | € | Largo (cm) | U.Venta |
|-------|------|------------|---------|
| 61615 | 5,60 | 15 | 12 |
| 61620 | 6,20 | 20 | 12 |



SI 250°C Max
Silicone BPA free

Batidor varilla silicona

Fouet en silicone · Ruhrbesen auf Silikon
Silicone wire whisk · Batedor vareta silicone

| Ref | € | Largo (cm) | U.Venta |
|-------|-------|------------|---------|
| 61621 | 8,20 | 20 | 12 |
| 61622 | 9,10 | 25 | 6 |
| 61623 | 10,20 | 30 | 12 |

Batidor Extra 8

Fouet inox extra 8 · Schneebeesen, Extra 8
Extra 8 whisk · Batedor Extra 8

| Ref | € | Largo (cm) | U.Venta |
|-------|-------|------------|---------|
| 61625 | 8,70 | 25 | 6 |
| 61630 | 8,90 | 30 | 6 |
| 61635 | 9,30 | 35 | 6 |
| 61640 | 10,30 | 40 | 6 |
| 61645 | 11,10 | 45 | 6 |
| 61650 | 12,40 | 50 | 6 |
| 61655 | 13,20 | 55 | 6 |
| 61660 | 14,20 | 60 | 6 |

Batidor gigante

Fouet à purée · Kesselbesen
Big whisk · Batedor gigante

| Ref | € | cm | Diámetro varilla (mm) | U.Venta |
|-------|-------|-----|-----------------------|---------|
| 60610 | 64,10 | 100 | 3 | 12 |
| 60612 | 82,20 | 129 | 3 | 12 |



Batidor Super 12

Fouet inox super 12 · Schneebeesen, super 12
Super 12 whisk · Batedor Super 12

| Ref | € | Largo (cm) | U.Venta |
|-------|-------|------------|---------|
| 61626 | 8,00 | 25 | 6 |
| 61631 | 8,60 | 30 | 6 |
| 61636 | 9,30 | 35 | 6 |
| 61641 | 9,90 | 40 | 6 |
| 61646 | 10,20 | 45 | 6 |
| 61651 | 11,10 | 50 | 6 |

INOX 18/10 SI Silicone HAYA Wood LFGB Food Grade Silicone Dishwasher BPA free

Batidor varilla con espátula

Fouet avec grattoir · Schneebeesen mit Schaber
Whisk with spatula · Batedeira de varas com espátula

| Ref | € | Largo (cm) | U.Venta |
|-------|------|------------|---------|
| 68199 | 6,10 | 27,0 | 1 |
| 61627 | 6,40 | 32,0 | 12 |

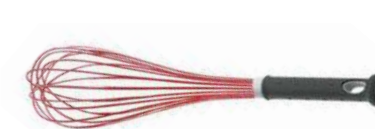

Especial para preparar comidas que no contengan alérgenos.
Specially for preparing meals that do not contain allergens.

SI 250°C Max
Silicone BPA free

Batidor Fibreglass

Fouet · Schneebeesen
Whisk · Batedores

| Ref | € | Largo (cm) | U.Venta |
|-------|-------|------------|---------|
| 61624 | 12,10 | 25 | 6 |
| 61629 | 14,00 | 30 | 6 |
| 61634 | 15,80 | 35 | 6 |
| 61639 | 17,50 | 40 | 6 |
| 61644 | 21,00 | 45 | 6 |
| 61649 | 22,00 | 50 | 6 |

INOX

Batidor Manivela

Batteur-mélangeur à manivelle · Schneequirl
Egg beater · Batedor de manivela

| Ref | € | U.Venta |
|-------|-------|---------|
| 62901 | 19,60 | 6 |



Batidor antialérgico Fibreglass

Fouet · Schneebeesen
Whisk · Batedores

| Ref | € | Largo (cm) | U.Venta |
|-------|-------|------------|---------|
| 61590 | 11,10 | 25 | 6 |
| 61591 | 12,00 | 30 | 6 |
| 61592 | 14,00 | 35 | 6 |

Batidor silicona Fibreglass

Fouet en silicone · Schneebeesen, Silikon
Silicone whisk · Batedores silicone

| Ref | € | Largo (cm) | U.Venta |
|-------|-------|------------|---------|
| 61524 | 11,10 | 25 | 6 |
| 61529 | 12,00 | 30 | 6 |
| 61534 | 14,00 | 35 | 6 |

- Batidor de varilla con práctico raspador de silicona incorporado.
- 2 en 1: bate y recoge toda la mezcla del bol de forma fácil y rápida.
- Varillas fabricadas en acero inoxidable.
- Espátula de silicona inyectada en una de las varillas (certificado LFGB y libre de BPA).

- Mixeur en bâton avec raclette en silicone intégrée très pratique.
- 2 en 1: fouette et recueille tous les mélanges dans le bol rapidement et facilement.
- Lames en acier inoxydable.
- Spatule en silicone injectée dans l'une des lames (certifiée LFGB et sans BPA).

- Blade mixer with practical built-in silicone scraper.
- 2 in 1: Beat and scrape out the entire mixture from the bowl quickly and easily.
- Rods made of stainless steel.
- Silicone spatula injected into one of the blades (LFGB certified and BPA free).





Coladores

INOX 18/10
Dishwasher

Posibilidad de completar colador en 4 sectores solicitando 4 unidades
Possibility of completing strainer in 4 sectors requesting 4 units



Colador 4 sectores
Passoire · Teigwaren-Einsatz
Colander · Coador

| Ref | € | Ø (cm) | h(cm) | U.Venta |
|-------|-------|--------|-------|---------|
| 50334 | 71,40 | 36 | 23,0 | 1 |
| 50338 | 86,50 | 40 | 26,0 | 1 |

Colador tipo cazo
Passoire à queue · Seihner mit Stiel
Strainer · Coador

| Ref | € | Ø (cm) | h(cm) | L | U.Venta |
|-------|-------|--------|-------|-----|---------|
| 50320 | 57,20 | 20 | 12 | 3,5 | 1 |
| 50324 | 65,20 | 24 | 14 | 6,5 | 1 |
| 50328 | 76,40 | 28 | 15 | 9,3 | 1 |



Colador chino
Passoire "Chinois" · Spitzsieb mit Flachstiel
"Chinese" strainer · Passador chinês

| Ref | € | Ø (cm) | U.Venta |
|-------|-------|--------|---------|
| 60311 | 17,80 | 10 | 1 |
| 60313 | 18,30 | 12 | 1 |
| 60315 | 19,20 | 14 | 1 |
| 60317 | 21,00 | 16 | 1 |
| 60318 | 22,20 | 18 | 1 |
| 60320 | 24,00 | 20 | 1 |
| 60322 | 26,10 | 22 | 1 |
| 60324 | 27,40 | 24 | 1 |
| 60326 | 29,40 | 26 | 1 |

Colador chino con pestaña
Passoire "Chinois" manche fil · Spitzsieb mit Rundstiel
Wire handle "Chinese" strainer · Passador chinês c/flange

| Ref | € | Ø (cm) | U.Venta |
|--------|-------|--------|---------|
| 60316P | 17,60 | 16 | 1 |
| 60318P | 18,80 | 18 | 1 |
| 60320P | 20,20 | 20 | 1 |
| 60322P | 22,90 | 22 | 1 |
| 60324P | 24,40 | 24 | 1 |

Colador chino sin pestaña
Passoire "Chinois" manche fil · Spitzsieb mit Rundstiel
Wire handle "Chinese" strainer · Passador chinês s/flange

| Ref | € | Ø (cm) | U.Venta |
|--------|-------|--------|---------|
| 60316V | 18,30 | 16 | 1 |
| 60319V | 20,70 | 20 | 1 |



Colador chino de malla
Passoire "Chinois" toile-metallique · Gazespitzsieb
Meshed "Chinese" strainer · Coador chinês de rede

| Ref | € | Ø (cm) | U.Venta |
|-------|-------|--------|---------|
| 60319 | 28,60 | 18 | 1 |
| 60321 | 35,40 | 20 | 1 |
| 60323 | 35,80 | 22 | 1 |
| 60325 | 39,30 | 24 | 1 |

Colador malla c/refuerzo
Chinois toile-metallique a croissillon · Gewebedurchschlang, konisch, verstärkt
Conical mesh strainer w/protection · Coador de rede c/reforço

| Ref | € | Ø (cm) | U.Venta |
|-------|-------|--------|---------|
| 62621 | 54,20 | 20x22 | 1 |



Colador 1/2 esfera
Passe-bouillon · Passiersieb
Sieve · Coador 1/2

| Ref | € | Ø (cm) | U.Venta |
|-------|-------|--------|---------|
| 62680 | 5,30 | 8 | 1 |
| 62610 | 8,90 | 10 | 1 |
| 62612 | 11,50 | 12 | 1 |
| 62614 | 13,20 | 14 | 1 |
| 62616 | 15,60 | 16 | 1 |
| 62618 | 18,30 | 18 | 1 |
| 62620 | 23,70 | 20 | 1 |
| 62623 | 28,50 | 23 | 1 |

Colador Cónico
Passoire conique · Passiersieb, konisch
Conical sieve · Coador cónico

| Ref | € | Ø (cm) | U.Venta |
|-------|-------|--------|---------|
| 62690 | 7,20 | 8 | 1 |
| 62611 | 9,60 | 10 | 1 |
| 62613 | 12,30 | 12 | 1 |
| 62615 | 15,40 | 14 | 1 |
| 62617 | 18,20 | 16 | 1 |
| 62619 | 21,10 | 18 | 1 |

Nidos de alambre
Panier à nid · Nestbacklöffel
Bird's nest mould · Ninhos de arame

| Ref | € | cm | Largo (cm) | U.Venta |
|-------|-------|------|------------|---------|
| 62957 | 23,20 | 7-9 | 35 | 1 |
| 62959 | 27,10 | 9-11 | 37 | 1 |



INOX PP
Polypropylene BPA free

Colador Drain
Passe-bouillon · Passiersieb
Sieve · Coador

| Ref | € | Ø (cm) | U.Venta |
|-------|-------|--------|---------|
| 62697 | 5,30 | 7,5 | 6 |
| 62691 | 8,00 | 12,0 | 6 |
| 62698 | 12,70 | 18,0 | 6 |
| 62692 | 14,60 | 22,0 | 1 |

Mango de madera
Wooden handle



INOX

Colador doble malla
Passoir maillee · Passiersieb, stark
Mesh strainer · Coador rede dupla

| Ref | € | Ø (cm) | Largo (cm) | U.Venta |
|-------|-------|--------|------------|---------|
| 61316 | 8,30 | 16 | 32,0 | 1 |
| 61318 | 9,70 | 18 | 34,0 | 1 |
| 61320 | 11,30 | 20 | 37,0 | 1 |
| 61323 | 28,80 | 23 | 56,0 | 1 |
| 61326 | 31,30 | 26 | 58,0 | 1 |
| 61330 | 55,80 | 30 | 78,5 | 1 |
| 61335 | 67,30 | 35 | 84,0 | 1 |

2 Ganchos
2 Hooks

1 Gancho
1 Hook

Alambre estañado · Fil étamé · Tinned wire

HAYA
Wood Dishwasher

Mano chino
Poussoir à chinois · Holz-Stößel
Chinesse strainer pusher · Pilão p/passador chinês

| Ref | € | Largo (cm) | U.Venta |
|-------|------|------------|---------|
| 60300 | 6,30 | 25 | 1 |



PE
Polyethylene BPA free

Triángulo
Triangle · Dreieck
Triangle · Triângulo

| Ref | € | U.Venta |
|-------|-------|---------|
| 60402 | 56,80 | 1 |

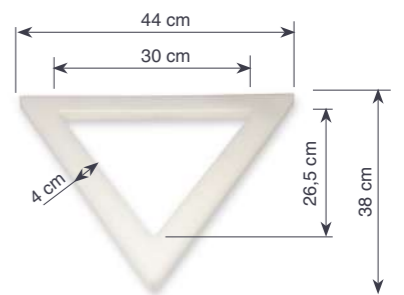



Escurridores

INOX
18/10
Dishwasher



Escurridor Inox
Passoire · Abtropfschale
Straine · Escorredor

| Ref | € | Ø (cm) | h (cm) | U.Venta |
|-------|-------|--------|--------|---------|
| 62732 | 18,50 | 22 | 8 | 1 |
| 62736 | 22,00 | 26 | 10 | 1 |

- Escurridor fabricado en acero inoxidable 18/10 de máxima calidad.
- Multifunción; diseñado para escurrir, colar y tamizar.
- Ideal para lavar todo tipo de verduras y frutas, colar pasta o arroz, etc.
- Se adapta a todo tipo de ollas, cacerolas, cazos, etc.
- Las asas laterales de acero inoxidable le otorgan robustez y firmeza y están diseñadas para un agarre cómodo y seguro.
- 100% apilable.
- Apto para lavavajillas.

- Strainer made from top quality 18/10 stainless steel.
- Multifunctional: designed for sifting, draining, straining and sieving.
- Ideal for washing all kinds of vegetables and fruit, straining pasta or rice, etc.
- Fits all types of pots, pans, casseroles, saucepans, etc.
- Fitted with strong, sturdy stainless steel side handles for a comfortable, secure grip.
- 100% stackable.
- Dishwasher safe.

- Fabricado en silicona de gran calidad, libre de BPA.
- Resistente, ligero, flexible y cómodo de usar.
- Orificios en la base y paredes para una mayor eficiencia.
- Dos prácticas asas laterales y aro de refuerzo de acero para un mejor manejo y estabilidad.
- 100% plegable: diseñado para ahorrar espacio de almacenamiento en la cocina.
- Multifuncional: ideal para escurrir gran variedad de alimentos como pastas, verduras, frutas, etc.
- Fácil de limpiar, apto para el lavavajillas.

- Made of high quality silicone, BPA free.
- Durable, lightweight, flexible and comfortable to use.
- Holes in the base and walls for greater efficiency.
- Two practical side handles and steel reinforcement ring for better handling and stability.
- 100% foldable: designed to save storage space in the kitchen.
- Multifunctional: ideal for draining a wide variety of foods such as pasta, vegetables, fruit, etc.
- Easy to clean, dishwasher safe.



SI
Silicone
BPA free

Escurridor plegable
Passoire Pliable · Zusammenklappbares Sieb
Folding strainer · Escorredor dobrável

| Ref | € | Ø (cm) | h (cm) | U.Venta |
|-------|-------|--------|--------|---------|
| 62884 | 14,80 | 24 | 10 | 1 |

new

new



Escurridera con base
Passoire sur pied · Abtropfschüssel mit Fussreif
Colander with stand · Escorredora com base

| Ref | € | Ø (cm) | h (cm) | L | U.Venta |
|-------|--------|--------|--------|------|---------|
| 50332 | 222,70 | 32 | 18 | 9,5 | 1 |
| 50336 | 270,70 | 36 | 19 | 12,0 | 1 |
| 50340 | 317,10 | 40 | 21 | 14,5 | 1 |



Escurridera cónica con base
Passoire conique sur pied · Abtropfschüssel
Conical colander with stand · Escorredor cónico com base

| Ref | € | Ø (cm) | h (cm) | L | U.Venta |
|-------|--------|--------|--------|------|---------|
| 50829 | 72,60 | 28 | 17 | 13,2 | 1 |
| 50833 | 79,70 | 32 | 20 | 14,5 | 1 |
| 50837 | 90,80 | 36 | 23 | 16,0 | 1 |
| 50841 | 98,30 | 40 | 26 | 18,0 | 1 |
| 50846 | 112,70 | 45 | 29 | 20,0 | 1 |
| 50851 | 128,20 | 50 | 33 | 22,0 | 1 |

garinox®



INOX

Escurridera Garinox
Passoire · Abtropfschüssel
Colander · Escorredor

| Ref | € | Ø (cm) | L | U.Venta |
|-------|-------|--------|-----|---------|
| 14122 | 18,90 | 22 | 3,0 | 1 |
| 14125 | 23,20 | 25 | 5,0 | 1 |
| 14130 | 33,60 | 30 | 8,0 | 1 |

Malla metálica donde se depositan los alimentos
Metal mesh where food is deposited

Agujeros · Holes
1x1 cm



Recipiente donde se recoge el aceite sobrante
Container where excess oil is collected

Escurrefritos
Passoire a friture · Abtropfschüssel für Frittiertes
Fry colander · Escorre-fritos

| Ref | € | cm | h (cm) | U.Venta |
|-------|--------|-------|--------|---------|
| 50541 | 186,30 | 40x29 | 8,0 | 1 |
| 50551 | 219,70 | 50x39 | 8,0 | 1 |
| 50561 | 252,40 | 60x39 | 8,0 | 1 |



Escurridor extensible
Passoire extensible pour l'évier · Spülbank-Sieb, ausziehbar
Extendable sink strainer · Escorredor extensível para bancada

| Ref | € | cm | U.Venta |
|-------|-------|----------|---------|
| 62987 | 24,70 | 34-54x24 | 1 |

Ayuda a preparar rebozados perfectos
Helps prepare perfect batters



Harina tamizada, para su recuperación
Sifted flour, for its recovery

Harinero
Tamis à farine à glissière · Mehlbehälter
Flour bin mesh · Farinheiro

| Ref | € | cm | h (cm) | U.Venta |
|-------|--------|---------|--------|---------|
| 50438 | 167,10 | 37x26,5 | 18 | 1 |
| 50450 | 172,50 | 50x26,5 | 18 | 1 |

Embudos

INOX 18/10 Dishwasher

new



- Embudo dosificador fabricado en acero inoxidable.
- Excelente resistencia a la corrosión, los ácidos alimentarios y sales.
- Capacidad 1,25 L.
- Ideal para rellenar o decorar platos con salsas y cremas calientes y frías.
- Sistema de palanca para un caudal ajustable; práctico y preciso. Boquilla de salida de 8 mm.
- Mango con diseño ergonómico que permite el manejo con una sola mano.
- Incluye soporte de gran estabilidad.
- Fácil limpieza, apto para el lavavajillas.

- Entonnoir à decor fabriqué en acier inoxydable.
- Doté d'une excellente résistance à la corrosion, aux acides alimentaires et aux sels.
- Capacité : 1,25 L.
- Idéal pour remplir ou décorer des assiettes avec des sauces chaudes et froides.
- Système de piston pour un débit ajustable ; pratique et précis. Buse de sortie de 8 mm.
- Manche ergonomique qui permet de le manipuler d'une seule main.
- Inclut un support très stable.
- Nettoyage facile et compatible avec le lave-vaisselle.

- Automatic piston portionner funnel made of 18/10 stainless steel.
- Excellent resistance to corrosion, food acids and salt.
- 1.25 L capacity.
- Perfect for filling or decorating dishes with hot or cold sauces and cream.
- Its lever system for controlling the flow is practical and precise. 8 mm outlet nozzle.
- The ergonomic handle means it can be used with just one hand.
- Includes high stability base.
- It's easy cleaning and it's dishwasher safe.

INOX Dishwasher

Dosificador embudo

Decor entonnoir · Doser dosiertrichter
Portionner funnel · Dosificador funil

| Ref | € | Ø (cm) | h(cm) | L | U.Venta |
|-------|-------|--------|-------|------|---------|
| 67151 | 22,10 | 13,5 | 26 | 1,25 | 1 |

Ranura de desgasificación

Filtro
Degassing groove. Filter



Ranura de desgasificación

Filtro extraíble
Degassing groove. Removable filter



Embudo con filtro

Entonnoir à filtre mobile · Trichter mit Sieb
Funnel with movable filter · Funil com filtro

| Ref | € | Ø (cm) | Ø inferior (cm) | U.Venta |
|-------|-------|--------|-----------------|---------|
| 62531 | 13,20 | 10 | 1,2 | 1 |
| 62513 | 15,40 | 12 | 1,5 | 1 |
| 62515 | 17,70 | 14 | 1,5 | 1 |

Embudo inox

Entonnoir · Trichter
Funnel · Funil

| Ref | € | Ø (cm) | U.Venta |
|-------|-------|--------|---------|
| 62512 | 16,10 | 12 | 1 |
| 62516 | 23,30 | 16 | 1 |
| 62521 | 30,20 | 20 | 1 |
| 62524 | 33,80 | 24 | 1 |

Cuello ancho para verter con mayor rapidez en tarros/botellas sin riesgo de quemaduras
Wide neck for faster pouring into jars / bottles without risk of burns



180°C Max Silicone BPA free

Embudo expandible

Entonnoir extensible · Trichter
Foldable funnel · Funil extensível

| Ref | € | Ø (cm) | h(cm) | U.Venta |
|-------|------|--------|-------|---------|
| 68085 | 6,10 | 8 | 10,5 | 1 |

Embudo mermelada

Entonnoir à confiture · Mermeladentrichter
Funnel for jam · Funil de congestionamento

| Ref | € | Ø (cm) | Ø inferior (cm) | h(cm) | U.Venta |
|-------|-------|--------|-----------------|-------|---------|
| 62517 | 10,30 | 13,5 | 6 | 6,5 | 1 |

Pinceles

SI INOX 230°C Max Dishwasher BPA free

- Para cocina o repostería.
- Pinceles ideales para pincelar con aceites o salsas, marinar carnes o pescados, engrasar moldes, untar con aceite, huevo batido, almíbar, etc.
- No absorben olores ni sabores.

- Pour la cuisine ou la pâtisserie.
- Pinceaux parfaits pour badigeonner de l'huile ou des sauces, mariner des viandes ou des poissons, graisser des moules, étaler de l'huile, de l'œuf battu, du sirop, etc.
- N'absorbent ni les odeurs ni les goûts.

- For cooking or baking.
- Brushes ideal for brushing oils or sauces, marinating meat or fish, greasing baking tins, and basting with oil, egg, syrup, etc.
- Doesn't absorb smells or tastes.

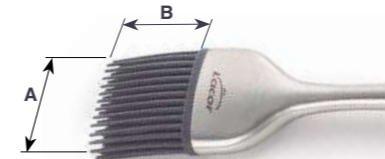

Pincel de silicona Pro

Pinceau en silicone · Silikonpinsel
Silicon brush · Pincel silicone

| Ref | € | A (cm) | B (cm) | Largo (cm) | U.Venta |
|-------|-------|--------|--------|------------|---------|
| 64418 | 11,10 | 4,0 | 4,0 | 22 | 1 |
| 64422 | 12,40 | 4,0 | 4,0 | 23 | 1 |

Pincel Virola

Pinceau · Silikonpinsel
Brush · Pincel

| Ref | € | A (cm) | B (cm) | Largo (cm) | U.Venta |
|-------|------|--------|--------|------------|---------|
| 64430 | 4,40 | 2,8 | 5,0 | 23,0 | 1 |
| 64435 | 5,10 | 3,2 | 5,5 | 24,0 | 1 |
| 64440 | 5,30 | 3,8 | 5,5 | 24,5 | 1 |
| 65044 | 6,60 | 4,2 | 6,5 | 25,0 | 1 |
| 65050 | 7,90 | 4,7 | 6,5 | 26,0 | 1 |

Dimensiones reales · Real dimensions

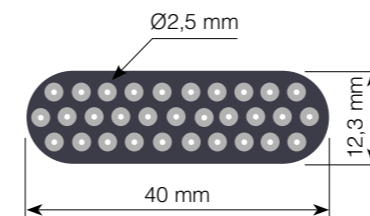

Pincel de silicona

Pinceau en silicone · Silikonpinsel
Silicon brush · Pincel de silicone

| Ref | € | A (cm) | B (cm) | Largo (cm) | U.Venta |
|-------|------|--------|--------|------------|---------|
| 64441 | 6,90 | 5,8 | 3,4 | 23 | 1 |

SI HAYA 230°C Max LFGFB Food Grade Silicone

Pincel de silicona Mix

Pinceau de cuisine en silicone · Silikonpinsel
Silicone brush · Pincel de silicone

| Ref | € | A (cm) | B (cm) | Largo (cm) | U.Venta |
|-------|------|--------|--------|------------|---------|
| 64431 | 7,40 | 3,8 | 4,0 | 24 | 12 |

| Ref | € | A (cm) | B (cm) | Largo (cm) | U.Venta |
|-------|------|--------|--------|------------|---------|
| 68196 | 4,20 | 5,5 | 3,1 | 24,5 | 1 |

Pincel de silicona Unite

Pinceau · Silikonpinsel
Brush · Pincel

Hervidores

INOX 18/10
Dishwasher



Hervidor extensible Inox

Panier marguerite extensible · Kocher, ausdehnbar, Rostfrei
Extensible steamer · Grelha extensível

| Ref | € | Ø (cm) | U.Venta |
|-------|-------|--------|---------|
| 60349 | 6,90 | 24 | 12 |
| 60348 | 10,10 | 28 | 12 |

Cuece especias

Diffuseur épices · Kräterkochsieb
Spice cooker · Cozedor de especiarias

| Ref | € | Ø (cm) | h(cm) | U.Venta |
|-------|-------|--------|-------|---------|
| 62958 | 12,60 | 4 | 15,4 | 1 |

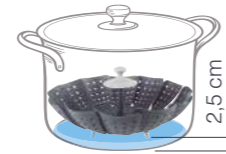

- Fabricado en polipropileno de máxima calidad, altamente resistente al calor, libre de BPA.
- Diseñado para cocinar los alimentos al vapor preservando todos sus nutrientes y vitaminas.
- Se adapta a diferentes tamaños de ollas gracias a sus hojas plegables.
- Almacenaje compacto; se pliega fácilmente y ocupa poco espacio.
- Tres pies antideslizantes de 2,5 cm de altura que no rayan la base de la olla.
- Pomo para una extracción segura.

- It's made of top quality BPA free polypropylene with high heat resistance.
- It's designed for steaming food and preserving all the vitamins and nutrients.
- It can fit different sizes of pots because of its collapsible leaves.
- Compact Storage: easy to fold up and doesn't take up a lot of space.
- It has three 2.5 cm tall non-slip feet that won't scratch the bottom of the pot
- Knob for safe and secure removal.



Hervidor pescado

Poissonniere avec grille · Fischkochkessel mit Einsatz
Fish kettle with grill · Peixeira

| Ref | € | cm | h(cm) | e (mm) | L | U.Venta |
|-------|--------|-------|-------|--------|-------|---------|
| 50440 | 105,60 | 40x19 | 11 | 0,8 | 10,05 | 1 |
| 50445 | 111,50 | 50x17 | 11 | 0,8 | 13,80 | 1 |
| 50460 | 145,60 | 60x19 | 11 | 0,8 | 20,80 | 1 |

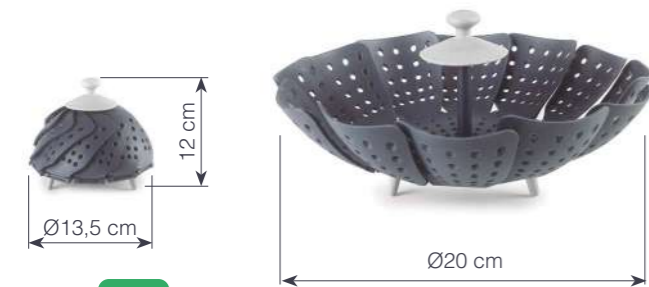

PP Polypropylene BPA free

Hervidor extensible Flor

Panier marguerite extensible · Kocher, ausdehnbar, Rostfrei
Extensible steamer · Grelha extensível

| Ref | € | Ø (cm) | h(cm) | U.Venta |
|-------|------|---------|-------|---------|
| 60288 | 8,20 | 13,5-26 | 12 | 1 |



Cacerola vapor

Panier vapeur · Dampfkoch-Aussatz o/Untertopf
Steam casserole · Caçarola a vapor

| Ref | € | Ø (cm) | h(cm) | e (mm) | U.Venta |
|-------|-------|--------|-------|--------|---------|
| 50428 | 60,50 | 28 | 11,0 | 0,8 | 1 |
| 50432 | 66,80 | 32 | 12,5 | 0,8 | 1 |



Huevo collection

INOX 18/10
Dishwasher



Separador de claras

Séparateur à oeuf · Eier-Separator
Eggs separator · Separador de ovos

| Ref | € | h(cm) | U.Venta |
|-------|------|-------|---------|
| 61608 | 8,00 | 3,0 | 6 |



Soporte huevo Ovum

Support d'oeufs · Eierbecher
Egg stand · Suporte de ovo

| Ref | € | Ø (cm) | h(cm) | U.Venta |
|-------|------|--------|-------|---------|
| 68285 | 3,00 | 4,5 | 5 | 6 |



SI Silicone BPA free

Molde huevo

Moule à oeufs · Eierform
Egg mould · Molde ovo

| Ref | € | cm | h(cm) | U.Venta |
|---------|------|-----------|-------|---------|
| A 68082 | 6,30 | 10,5x10,5 | 2,0 | 1 |
| B 68080 | 6,30 | Ø10 | 2,0 | 1 |

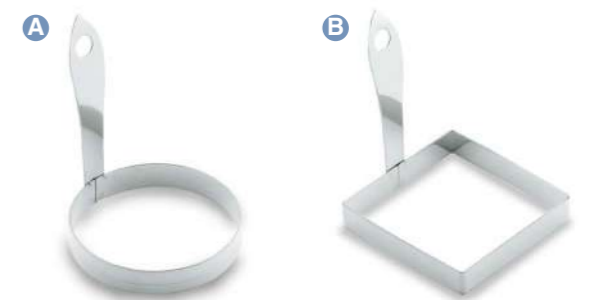

INOX

Molde huevo inox

Moule à oeufs-sandwich · Eier-/Sandwichring
Mould for egg-sandwich · Molde ovo-Sandwich

| Ref | € | cm | U.Venta |
|---------|------|---------|---------|
| A 68005 | 3,30 | Ø8,5 | 12 |
| B 68006 | 3,30 | 8,5x8,5 | 12 |

Garras de oso

INOX BAQUELITA
Bakelite Dishwasher

- Fabricadas en acero inoxidable de máxima calidad.
- Diseñadas para desmenuzar y manipular carnes hechas al horno o barbacoa, como pollo, carne de vacuno, pavo, aves, jamón, etc.
- Puntas afiladas para manipular la carne sin esfuerzo. Forma curvada para un mejor agarre y mayor comodidad.
- Mangos ergonómicos de baquelita resistentes al calor, 100% seguros.
- Multifuncional: desmenuza y traslada la carne, facilita la sujeción para cortes con cuchillo, remueve las ensaladas o pastas, etc.
- Fácil de limpiar. Aptas para el lavavajillas.

- Fabriqué en acier inoxydable de qualité maximale.
- Conçu pour s'effondrer et manipuler la viande de viande, comme le poulet, le bœuf, la dinde, les oiseaux, le jambon, etc.
- Des conseils pointus pour gérer la viande sans effort. Forme incurvée pour une meilleure adhérence et un plus grand confort.
- Mangues de baquelite ergonomiques résistantes à la chaleur, 100% d'assurance.
- Multifonctionnel: s'effondre et déplace la viande, facilite la fixation des coupures de couteau, retirer les salades ou les pâtes, etc.
- Facile à nettoyer. Convient au lave-vaisselle.

- Manufactured in maximum quality stainless steel.
- Designed to crumble and handle meat -made meats, such as chicken, beef, turkey, birds, ham, etc.
- Sharp tips to handle meat effortlessly. Curved form for a better grip and greater comfort.
- Ergonomic bakelite mangoes resistant to heat, 100% insurance.
- Multifunctional: crumbles and moves the meat, facilitates the fastening for knife cuts, remove salads or pasta, etc.
- Easy to clean. Suitable for dishwasher.

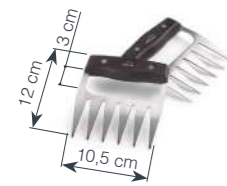

Garras de oso
Griffes à viande · Fleisch Bärenkrallen
Bear claws for meat · Garras de urso para carne

| Ref | € | cm | U.Venta |
|-------|-------|---------|---------|
| 38015 | 13,00 | 10,5x12 | 1 |



Manipula carnes. Desmenuza carnes
Manipulate meat. Crumble meats

Pasapurés

INOX 18/10
Dishwasher



Pasapurés
Presse-Puree · Passiergerät
Potato mashing machine · Passa-puré professional

| | Ref | € | Ø (cm) | Diámetro disco (cm) | Cuchillas | L | U.Venta |
|---|-------|--------|--------|---------------------|-----------|-----|---------|
| A | 60026 | 127,60 | 26 | 16,5 | 2 | 5,0 | 1 |
| | 60031 | 133,40 | 32 | 16,5 | 2 | 8,0 | 1 |
| B | 60030 | 84,60 | 30 | 16,5 | 2 | 3,5 | 1 |
| C | 60048 | 56,60 | 18 | 10,5 | 3 | 0,7 | 1 |
| | 60027 | 74,40 | 24 | 13,5 | 3 | 1,5 | 1 |
| D | 60021 | 57,40 | 20 | 11,5 | 2 | 1,5 | 1 |



Morteros

GRANITO
Granite BPA free

- Fabricados en granito de calidad premium.
- Interior no poroso, permite extraer los aceites naturales de las hierbas y especias.
- El diseño de la mano permite maniobrar con facilidad y con poco esfuerzo.
- Pesado y bien balanceado.

- Composé de granit de qualité supérieure.
- Intérieur non poreux permettant d'extraire les huiles essentielles des herbes et épices.
- La conception de la main facilite les manœuvres et réduit les efforts.
- Lourd et bien équilibré.

- Manufactured from premium quality granite.
- Interior not porous allowing extracting natural oils from herbs and spices.
- The design of the hand allows easy manoeuvres with little effort.
- Heavy and well balanced.



Mortero con mano de granito
Mortier et pilon en granit · Mörser und Stößel aus Granit
Granite mortar and pestles · Argamassa e pilão do granito

| | Ref | € | Ø (cm) | h(cm) | ml | U.Venta |
|---|-------|-------|--------|-------|-----|---------|
| A | 60512 | 26,50 | 12 | 8 | 250 | 1 |
| | 60514 | 30,90 | 14 | 10 | 375 | 1 |
| B | 60516 | 32,20 | 16 | 12 | 600 | 1 |
| C | 60517 | 25,70 | 10,5 | 7,5 | 225 | 1 |
| D | 60518 | 26,10 | 12 | 12,0 | 365 | 1 |

PE
Polyéthilène BPA free

Mortero White
Mortier · Mörser
Mortar · Almofariz

| Ref | € | Ø (cm) | U.Venta |
|-------|--------|--------|---------|
| 60403 | 165,10 | 18 | 1 |

Mano mortero
Poussoir à mortier · Stößel
Pestle · Pilão p/almofariz

| Ref | € | Ø (cm) | Largo (cm) | U.Venta |
|-------|-------|--------|------------|---------|
| 60401 | 40,30 | Ø4,8 | 25 | 1 |

Prensadores

INOX 18/10
Dishwasher



- Fabricado en acero inoxidable 18/10 de alta calidad y gran resistencia.
- Tritura sin esfuerzo cualquier alimento cocinado previamente o de textura blanda.
- Ideal para preparar puré de patata, tomate, calabaza, plátano, etc.
- Superficie de prensado diseñada para conseguir un acabado homogéneo.
- No transmite olores ni sabores a los alimentos.

- Fabriqué en acier inoxydable 18/10 de grande qualité et d'une résistance maximale.
- Triture sans effort tout aliment préalablement cuit ou à texture molle.
- Idéal pour préparer de la purée de pomme de terre, de courge, de banane, etc.
- Surface de pressage conçue pour obtenir un résultat homogène.
- Ne transmet ni odeurs ni goûts aux aliments.

- Made of top quality, high resistance 18/10 stainless steel.
- Easily mashes any pre-cooked or soft-textured foods.
- Ideal for mashing potatoes, tomatoes, pumpkin, bananas, etc.
- Mashing surface designed for even mashing, giving perfect results.
- Does not transmit odours or flavours.
- Smooth round handle for a comfortable and secure grip.



Prensador de patatas

Presse-purée · Kartoffelpresse
Potato masher · Prensa-batatas

| Ref | € | cm | h(cm) | U.Venta |
|----------------|--------------|----------|-------|---------|
| A 62892 | 19,90 | 10,5x8,5 | 24 | 1 |
| B 62896 | 18,40 | ∅11,6 | 45,5 | 1 |
| C 62897 | 8,70 | 11x7,5 | 17,5 | 1 |



Prensa patatas

Presse-pomme de terre · Kartoffelpresse
Potato press · Esmaga-batatas

| Ref | € | cm | U.Venta |
|-------|--------------|---------|---------|
| 62902 | 35,80 | 9x28x11 | 1 |

Molde empanadillas

Moule à chaussons · Pastetenformen
Dumpling mould · Forma para salgados

| Ref | € | Ø (cm) | U.Venta |
|-------|--------------|--------|---------|
| 68101 | 21,50 | 10 | 1 |
| 68102 | 23,50 | 12 | 1 |

Pica y lamina

Chop and slice



Accesorio para eliminar los restos

Accessory for eliminating the remains



Prensa ajos y laminador

Presse ail coupe · Knoblauchpresse, Schneider
Garlic press and slicer · Esmaga-alhos y laminador

| Ref | € | Largo (cm) | U.Venta |
|-------|--------------|------------|---------|
| 60387 | 27,10 | 20 | 1 |

- Diseñado para triturar y cortar en cubos los ajos volteando los mangos.
- Gran capacidad de carga (varios dientes a la vez).
- Mecanismo de presión perfecto para minimizar el esfuerzo.
- Robusto, cómodo, rápido y fácil de usar.
- Mangos antideslizantes y ergonómicos para un agarre seguro.
- Garantiza resultados perfectos.
- Incluye accesorio para una fácil limpieza

- Conçu pour écraser et couper l'ail en dés en tournant les poignées.
- Grande capacité de charge (plusieurs gousses en même temps).
- Mécanisme de pression parfait pour minimiser l'effort.
- Robuste, confortable, rapide et facile à utiliser.
- Poignées ergonomiques antidérapantes pour une bonne préhension.
- Résultats parfaits garantis.
- Comprend un accessoire de nettoyage

- Designed to chop and cube garlic by turning the handles.
- High capacity (several teeth at once).
- The pressure mechanism is perfect for minimising effort.
- Strong, comfortable and fast and easy to use.
- The non-slip and ergonomic handles make for a sturdy grip.
- Perfect results guaranteed.
- Includes cleaning accessory



Triturar



Cubos



2 en 1

ZAMAK Zinc Alloy
ABS Plastic
INOX

Prensa ajos Dual

Presse ail coupe · Knoblauchpresse
Garlic press · Esmaga-alhos

| Ref | € | h(cm) | U.Venta |
|-------|--------------|-------|---------|
| 60277 | 22,80 | 16 | 1 |



Prensa hamburguesas



Separadores · Separators



- Fabricado en aluminio fundido anodizado y acero inoxidable 18/10.
- Firme, robusto y resistente.
- Diseñado para un uso profesional intensivo y continuado; ideal para carnicerías, hamburgueserías, restaurantes, etc.
- Diámetro de la hamburguesa: Ø130 mm. Forma uniforme.
- Funcionamiento manual: mecanismo de palanca.
- Mecanismo de extracción rápida: extrae la hamburguesa con total facilidad.
- Depósito para almacenar las hojas separadoras y tenerlas a mano mientras se elaboran las hamburguesas.
- Pies de goma antideslizantes: máxima estabilidad durante el uso.
- Incluye 500 unidades de papel antiadherente perforado de Ø13 cm (evita que la carne se pegue a la hora de retirar el papel).

- Fabriqué en fonte d'aluminium anodisée et en acier inoxydable 18/10.
- Stable, robuste et résistante.
- Conçue pour un usage professionnel intensif et continu ; idéale pour les boucheries, les établissements de hamburgers, les restaurants, etc.
- Diamètre du steak haché : Ø130 mm. Forme uniforme.
- Fonctionnement manuel : mécanisme à levier.
- Mécanisme d'extraction rapide : extrait le steak haché avec une grande facilité.
- Compartiment pour ranger les feuilles de séparation et les avoir à portée de main pendant l'élaboration des steaks hachés.
- Pieds en caoutchouc antidérapant : stabilité maximale pendant l'utilisation.
- Inclut 500 unités de papier antiadhésif perforé de Ø13 cm (évite que la viande colle lors du retrait du papier).

- Made of anodized cast aluminium and 18/10 stainless steel.
- Rigid, robust and strong.
- Designed for intensive continuous professional use, and perfect for butcher shops, hamburger and other restaurants, etc.
- Patty diameter Ø130 mm consistent shape.
- Manual Operation: lever mechanism.
- Quick Release Mechanism: Patties can be removed very easily.
- Holder for storing separator sheets and keeping them handy when you're making patties.
- Non-slip Rubber Feet: Maximum stability during use.
- Includes 500 Ø13 cm sheets of non-stick paper with holes to keep the meat from sticking when the paper is removed.

AL FUNDIDO INOX
Aluminium Cast 18/10

Prensa hamburguesas profesional

Presse à hamburguers · Hamburger-Formen
Hamburg presser · Moldes para hamburgueres

| Ref | € | Hamburguesa Ø (cm) | U.Venta |
|-----------|--------|--------------------|---------|
| 60226 | 223,70 | 10 | 1 |
| A R60226A | 9,40 | 10 | 6 |
| 60227 | 243,70 | 13 | 1 |
| A R60227A | 9,90 | 13 | 6 |



AL FUNDIDO HAYA
Aluminium Cast Wood

Molde para hamburguesas Press

Presse à hamburguers · Hamburger-Formen
Hamburg presser · Moldes para hamburguesa

| Ref | € | Ø (cm) | U.Venta |
|---------|-------|----------|---------|
| 60258 | 15,00 | 11,5x7,5 | 1 |
| R60258A | 1,50 | 11 | 1 |



ABS Plastic BPA free

Molde para hamburguesas Multi

Presse à hamburguers · Hamburger-Formen
Hamburg presser · Moldes para hamburguesa

| Ref | € | Ø (cm) | U.Venta |
|---------|------|--------|---------|
| 60259 | 7,50 | 12,5x6 | 1 |
| R60259A | 1,40 | 10 | 1 |



Ø6,5 cm

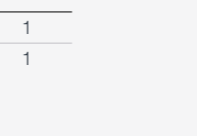
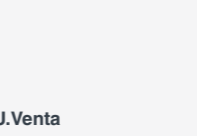
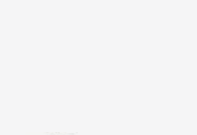
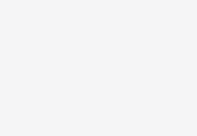

- Molde de aleación de aluminio fundido de gran calidad con recubrimiento antiadherente.
- Pomo de madera desmontable y ergonómico, permite una distribución uniforme de la presión para crear hamburguesas caseras de carne, vegetarianas o veganas.
- Perfectas en proporción y consistencia.
- Superficie interior acanalada; proporciona un aspecto profesional.
- Incluye 60 unidades de papel antiadherente de Ø11 cm.
- Fácil de limpiar.

- Moule d'alliage en aluminium fondu de haute qualité avec revêtement non stick.
- Le bouton de bois amovible et ergonomique permet une répartition uniforme de pression pour créer des hamburgers faits maison de viande, végétariens ou végétaliens.
- Parfait en proportion et en cohérence.
- Surface intérieure srangée; Il fournit un aspect professionnel.
- Comprend 60 unités inconnues de UNK de Ø11 cm.
- Facile à nettoyer.

- High quality molten aluminum alloy mold with non -stick coating.
- Removable and ergonomic wood knob, allows a uniform distribution of pressure to create homemade hamburgers of meat, vegetarian or vegan.
- Perfect in proportion and consistency.
- Stranged interior surface; It provides a professional aspect.
- Includes 60 unk's unknown units of Ø11 cm.
- Easy to clean.

- Fabricado en plástico ABS de alta calidad y durabilidad. Libre de BPA.
- Compuesto por 6 piezas totalmente desmontables.
- Versátil: ideal para preparar y rellenar todo tipo de hamburguesas.
- Base extraíble acanalada para facilitar la extracción de la hamburguesa.
- Compacto: se guarda en una sola pieza.
- Práctico y muy fácil de usar.
- Medidas (mm): hamburguesa grande Ø10x3 cm / mini Ø6,5x2 cm.
- Incluye 60 unidades de papel antiadherente de Ø10 cm.
- Fácil de limpiar. Apto para el lavavajillas.

- Fabriqué en plastique ABS de haute qualité et durabilité. Sans BPA.
- Composé de 6 pièces totalement amovibles.
- Polyvyle: Idéal pour préparer et remplir toutes sortes de hamburgers.
- Base amovible pour faciliter l'extraction du hamburger.
- Compact: il est enregistré en une seule pièce.
- Pratique et très facile à utiliser.
- Mesures (mm): grand hamburger Ø10x3 cm / mini Ø6,5x2 cm.
- Comprend 60 unités de papier antiadhérentes Unkly Ø10 cm.
- Facile à nettoyer. Apte pour le lave-vaisselle.



FE FUNDIDO
Iron Cast

new

- Prensa de carne fabricada en hierro fundido de gran calidad y resistente a altas temperaturas.
- Diseñado con una superficie acanalada para dar a tus carnes, hamburguesas, smash burgers, sándwiches, bistec, etc. marcas de parrilla perfectas.
- Mango ergonómico de madera natural, proporciona un agarre cómodo y seguro.

- Presse à steak fabriquée en fonte de grande qualité et résistante à de hautes températures.
- Conçue avec une surface cannelée pour donner à vos viandes (steaks hachés, smash burgers, sandwichs, beefsteaks, etc.) des marques de grill parfaites.
- Manche ergonomique en bois naturel, qui confère une prise en main pratique et sûre.

- Meat press made of high quality cast iron. Resistant to high temperatures.
- Designed with a ribbed surface to give your meat, burgers, smash burgers, sandwichs, steaks, etc. perfect grill marks.
- Ergonomic natural wood handle for a comfortable, secure grip.

Prensador carne Magma

Presse à steak · Fleischpresse
Meat press · Prensador de carne

| Ref | € | cm | h(cm) | U.Venta |
|---------|-------|-------|-------|---------|
| A 25862 | 15,00 | Ø17,5 | 8,0 | 1 |
| B 25863 | 18,40 | 23x11 | 8,0 | 1 |

Ablandacarnes

INOX 18/10 Dishwasher



- **Sólida, robusta y especialmente pesada (734 g) para ablandar, aplanar y ensanchar fácilmente todo tipo de carnes.**
- **Gran superficie de aplastado (espesor de 12 mm.)**
- **Mango robusto ergonómico para un fácil manejo con práctica presilla para colgar.**
- **Higiénica e inodora, no absorbe los olores de los alimentos.**

- Solide, extrêmement robuste et spécialement conçu pour attendrir, aplatir et élargir facilement tout type de viande.
- Grande surface de travail avec une épaisseur de 12 mm.
- Manche robuste et ergonomique pour une prise en main facile et un crochet pratique pour le suspendre.
- Hygiénique et inodore, il n'absorbe pas les odeurs des aliments

- Solid, extremely robust and specially designed (734 g) to easily tenderise, flatten and widen all types of meat.
- Large 12 mm thick flattening surface.
- Sturdy, ergonomic handle for firm grip and easy handling.
- Features a practical hanging eye.
- Hygienic and odourless: does not absorb odours or flavours

Maza ablandacarne

Attendrisseur de viande · Fleischhammer
Meat mallet · Maço para amciar carne

| Ref | € | cm | h(cm) | U.Venta |
|-------|-------|------|-------|---------|
| 61251 | 25,80 | 27x8 | 11,0 | 1 |

Liso para reducir el grosor de la carne.
Rugoso para ablandar y para que penetre mejor los adobos

Smooth side, to reduce the thickness of the meat.
Rough side for softening and better marinade penetration



Mango ergonómico y antideslizante
Ergonomic non-slip handle



INOX

Ablandacarne Inox

Attendrisseur à viande en Inox · Fleischklopfel, Edelstahl
St. steel meat tenderizer · Ablandacarne Inóx

| Ref | € | cm | U.Venta |
|-------|-------|------|---------|
| 60432 | 38,70 | 12x2 | 1 |

- **48 cuchillas extremadamente afiladas fabricadas en acero inoxidable.**
- **Las cuchillas crean pequeños canales térmicos dentro de la carne, permitiendo que el calor penetre y se distribuya uniformemente.**
- **Ideal para preparar todo tipo de carnes para que queden más jugosas, sabrosas y blandas.**
- **Las cuchillas se retraen automáticamente al dejar de presionar.**
- **Mango ergonómico antideslizante, garantiza un agarre seguro y eficiente.**
- **Diseño seguro con cubierta protectora.**

- 48 lames extrêmement aiguës fabriquées en acier inoxydable de grande qualité.
- Les lames créent de petits canaux thermiques dans la viande, permettant ainsi à la chaleur de pénétrer et de se répandre uniformément.
- Idéal pour préparer tout type de viandes afin qu'elles soient juteuses, savoureuses et tendres.
- Les lames se rétractent automatiquement dès que l'on cesse d'appuyer sur l'appareil.
- Manche ergonomique antidérapant qui garantit une prise en main sûre et efficace.
- Conception sûre avec couvercle de protection.

- 48 extremely sharp high quality stainless steel blades.
- The blades create small heat channels in the meat, ensuring even heat absorption and distribution.
- Ideal for cooking all kinds of meat for more succulent, tender and juicy dishes.
- The blades retract automatically when you stop pressing.
- Ergonomic, non-slip handle for a comfortable, safe grip.
- Safe design with protective cover.

Ablandacarne Black

Attendrisseur de viande · Fleischhammer
Meat mallet · Maço para amciar carne

| Ref | € | Cuchilla (cm) | U.Venta |
|-------|------|---------------|---------|
| 61250 | 9,10 | 6x3 | 1 |



Exprimidores manuales

INOX 18/10 Dishwasher



Exprimidor Inox

Presse citron manuel · Manuelle zitronenpresse
Manual reamer · Espremedor manual

| Ref | € | Ø (cm) | L | U.Venta |
|-------|-------|--------|------|---------|
| 62952 | 18,10 | 10 | 0,15 | 6 |
| 62912 | 21,20 | 12 | 0,20 | 6 |



Exprimidor manual inox

Presse-ruits manuel · Manuelle fruchtpresse
Manual squeezer · Espremedor de sumos

| Ref | € | cm | h(cm) | U.Venta |
|-------|-------|-------|-------|---------|
| 63914 | 55,20 | 15x19 | 39,0 | 1 |

Exprimidor manual Flor

Presse citron manuel · Manuelle zitronenpresse
Manual reamer · Espremedor manual

| Ref | € | Ø (cm) | h(cm) | U.Venta |
|-------|-------|--------|-------|---------|
| 63912 | 13,00 | 4,5 | 16 | 1 |



Exprimidor limón

Presse-citron · Zitruspresse
Lemon squeezer · Espremedor de limão

| Ref | € | cm | U.Venta |
|-------|-------|----------------|---------|
| 62946 | 12,00 | 12 x 2,5 x 5,5 | 1 |

PP Polypropylene BPA free



Exprimidor manual mini

Presse citron manuel · Manuelle zitronenpresse
Manual reamer · Espremedor manual

| Ref | € | cm | h(cm) | ml | U.Venta |
|-------|------|--------|-------|----|---------|
| 68181 | 6,60 | 10x9,5 | 8,5 | 70 | 1 |



Exprimidor manual

Presse citron manuel · Manuelle zitronenpresse
Manual reamer · Espremedor manual

| Ref | € | Largo (cm) | U.Venta |
|---------|-------|------------|---------|
| A 63915 | 11,40 | 22 | 1 |
| B 68182 | 26,50 | 22 | 1 |

ABS Plastic BPA free



Exprimidor manual con jarra medidora

Presse citron manuel · Manuelle zitronenpresse
Manual reamer · Espremedor manual

| Ref | € | cm | h(cm) | L | U.Venta |
|-------|------|-----------|-------|-----|---------|
| 67134 | 7,50 | 18,5 x 11 | 15 | 0,5 | 1 |

- **Excelente resistencia a la corrosión; no se oxida o reacciona a los jugos de los cítricos.**
- **Ideales para exprimir limas, limones y naranjas.**
- **Superficie acanalada para extraer el máximo jugo.**
- **Mango ergonómico para un fácil exprimido y un menor esfuerzo.**
- **Apto para el lavavajillas.**

- It has excellent corrosion resistance and does not rust or react to citrus juice.
- It's perfect for squeezing limes, lemons and oranges.
- Grooved surface for maximum juice extraction.
- It has an ergonomic handle to make squeezing juice easy and almost effortless.
- Dishwasher safe.



Ideal para limas, limones, naranjas e incluso pomelos
Ideal for limes, lemons, oranges and even grapefruit



Colección Smart



- **Bomba de vacío inalámbrica. Práctica y silenciosa.**
- **Extrae el aire en segundos con solo pulsar un botón.**
- **Capacidad de succión de 2,5L/min.**
- **Los alimentos se mantienen frescos durante más tiempo.**
- **El proceso de vacío se detiene automáticamente al crear un vacío adecuado.**
- **Se carga a través del cable USB (incluido).**
- **Batería de iones de litio de larga duración.**
- **Diseño elegante, moderno y compacto.**

- **Pompe à vide sans fil. Pratique et silencieuse.**
- **Extrait l'air en quelques secondes en appuyant sur un simple bouton.**
- **Capacité d'aspiration de 2,5L/min.**
- **Les aliments restent frais plus longtemps.**
- **Le processus de vidage s'arrête automatiquement dès que le vide adéquat est obtenu.**
- **Rechargeable par câble USB (inclus).**
- **Batterie lithium-ion de longue durée.**
- **Design élégant, moderne et compact.**

- **Wireless vacuum pump. Practical and quiet.**
- **Extracts air in seconds with the push of a button**
- **2.5 L/min suction capacity**
- **Food stays fresh longer**
- **The vacuum process stops automatically when a suitable vacuum has been created.**
- **It is charged with a USB cable (included).**
- **Long-lasting lithium-ion battery**
- **Elegant, modern and compact design. Saves storage space.**

new

Bomba de vacío Smart

Pompe à vide · Vakuumpumpe
Vacuum pump · Bomba de vacío

| Ref | € | Ø (cm) | h(cm) | U.Venta |
|-------|-------|--------|-------|---------|
| 69690 | 41,10 | 4,3 | 16,3 | 1 |



Bomba de vacío + 4 recipientes

Ensemble de pompe à vide + 4 récipients ·
Vakuumpumpensatz + 4 Behälter
Bomba de vacío + 4 recipientes ·
Conjunto de bomba de vacío + 4 recipientes

| Ref | € | U.Venta |
|-------|-------|---------|
| 69698 | 84,50 | 1 |

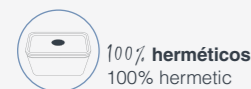

Recipiente Smart

Récipient · Behälter
Container · Recipiente

| Ref | € | cm | U.Venta | ml | h(cm) |
|-------|-------|-----------|---------|------|-------|
| 69691 | 7,00 | 15x11 | 1 | 550 | 6,0 |
| 69692 | 9,40 | 18,8x13 | 1 | 1200 | 8,0 |
| 69693 | 12,40 | 22,5x15,5 | 1 | 1500 | 7,0 |
| 69694 | 14,40 | 22,5x15,5 | 1 | 2300 | 10,0 |

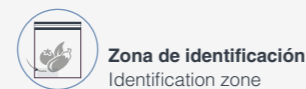
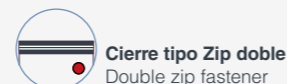

Bolsas Smart

Sacs · Taschen
Bags · Sacos

| Ref | € | cm | U.Venta | Piezas |
|-------|-------|-----------|---------|--------|
| 69695 | 7,50 | 20x23 | 1 | 10 |
| 69696 | 10,40 | 26x35 | 1 | 10 |
| 69697 | 8,60 | 30x49 | 1 | 5 |
| 69699 | 10,90 | 20x23 (5) | 1 | 12 |
| | | 26x35 (5) | | |
| | | 30x49 (2) | | |

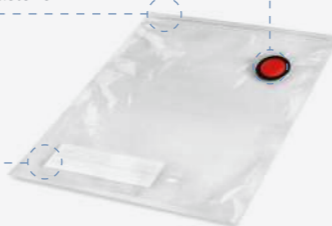

Contenedor de alimentos



PE ASA BPA free
Polyethylene Acrylic

Contenedor de alimentos
Boîte à condiments · Gewürzkasten
Condiments holder · Caixa condimentos

| Ref | € | cm | ml | Compartimentos | U.Venta |
|-------|-------|---------|------|----------------|---------|
| 61133 | 28,50 | 50x16x9 | 1000 | 3 | 1 |
| 61134 | 28,50 | 50x16x9 | 750 | 4 | 1 |
| 61135 | 28,50 | 50x16x9 | 600 | 5 | 1 |
| 61136 | 28,50 | 50x16x9 | 450 | 6 | 1 |



Organizadores Organizer

PET ABS SI BPA free
Plastic Plastic Silicone



- **Diseñado para almacenar todo tipo de alimentos secos.**
- **Tapa hermética con cierre de silicona; mantiene los alimentos frescos durante más tiempo.**
- **Tapa con mecanismo de cierre y apertura patentado que permite su manipulación con una sola mano.**
- **Modular y apilable. Ahorra espacio en la cocina.**
- **Recipiente fabricado en plástico resistente, 100% libre de BPA.**

- Conçu pour ranger tout type d'aliments secs.
- Couvercle hermétique avec fermeture en silicone ; maintient les aliments frais plus longtemps.
- Couvercle avec mécanisme d'ouverture et fermeture breveté qui permet une manipulation avec une seule main.
- Modulable et empilable. Gain de place dans la cuisine.

- Recipient fabriqué en plastique résistant, 100% sans BPA
- Designed for storing all types of dry food.
- Airtight lid with silicone seal to keep food fresh for longer.
- Lid with patented opening and closing mechanism for easy one-handed operation.
- Modular and stackable for saving space in the kitchen.
- Container made of resistant BPA-free plastic

Organizadores Organizer

Boîtes · Boxen oder behälter
Canisters · Botes

| | Ref | € | cm | h(cm) | L | U.Venta |
|---|-------|------|-----------|-------|-----|---------|
| A | 64624 | 5,60 | 10,5x10,5 | 8,0 | 0,4 | 1 |
| B | 64621 | 7,10 | 10,5x10,5 | 16,0 | 1,0 | 1 |
| C | 64625 | 8,40 | 10,5x10,5 | 23,5 | 1,5 | 1 |
| D | 64627 | 6,60 | 10,5x15,5 | 8,00 | 0,7 | 1 |
| E | 64626 | 8,40 | 10,5x15,5 | 16,00 | 1,6 | 1 |





Máquina laminadora de pasta

INOX

- Rodillos de acero inoxidable, permiten conseguir hasta 9 grosores de pasta.
- Posibilidad del accesorio para raviolis.

- Rouleaux en acier inoxydable, permettent jusqu'à 9 épaisseurs de pâte.
- Possibilité d'accessoires de raviolis.

- Stainless steel rollers, allow up to 9 paste thickness.
- Possibility of raviolis accessory.



Regulador de grosor de pasta (3,4 mm - 0,93 mm)
Pasta thickness Regulator (3,4 mm - 0,93 mm)



Solo puede utilizarse en la máquina de 145 mm (Ref: 60390)
Only can be used in the machine of 145 mm (Ref: 60390)

Accesorios para ravioli

Accessoire pour raviolis · Zubehör für Ravioli
Ravioli maker · Accesorio para raviolis

| | Ref | € | Medidas ravioli | U.Venta |
|---|-------|-------|-----------------|---------|
| A | 60497 | 22,40 | 45x45 mm | 1 |
| B | 60498 | 22,40 | 30x30 mm | 1 |

INOX

Medidor de pasta inox

Mesureur pour pâtes en Inox · Spaghetti-Mass Rostfrei
St steel pasta measurer · Medidor para macarrão en Inóx

| | Ref | € | cm | U.Venta |
|---|-------|------|------|---------|
| A | 62942 | 3,40 | 18 | 1 |
| B | 62943 | 4,70 | 11x9 | 1 |



Máquina laminadora de pasta
Machine Lamineuse à pâte · Pastamaschine
Pasta Machine Slicer · Máquina de Pasta

| | Ref | € | Espesor corte mm | U.Venta |
|---|-------|-------|------------------|---------|
| A | 60390 | 46,60 | 0,2 - 3 mm | 1 |
| B | 60391 | 86,10 | 0,2 - 3 mm | 1 |

Embutidora

INOX 18/10
Dishwasher

Incluye boquillas
Includes nozzles



Máquina embutidora

Poussoir manuel · Manuelle Wurstfüller
Manual stuffer · Máquina para encher salsichas manual

| Ref | € | h(cm) | Cilindro (cm) | L | U.Venta |
|-------|--------|-------|---------------|----|---------|
| 60253 | 286,30 | 52,3 | Ø14 x 20 | 3 | 1 |
| 60255 | 328,20 | 64,7 | Ø14 x 32 | 5 | 1 |
| 60257 | 378,50 | 78,0 | Ø14 x 46 | 7 | 1 |
| 60251 | 435,90 | 60,5 | Ø22 x 27 | 10 | 1 |

- Fabricada en acero inoxidable 18/10 de gran calidad.
- Rápida y eficaz: diseñada para elaborar diferentes tipos de embutidos como chorizos, salchichas, butifarras, etc.
- Gran capacidad: ideal para carnicerías, restaurantes y cocinas industriales.
- Doble velocidad (lenta/rápida) gracias a un mecanismo de dos marchas accionado por rodamiento.
- Incluye 4 boquillas de llenado de acero inoxidable: Ø38 mm, Ø32 mm, Ø22 mm y Ø16 mm.
- Tuerca de unión de fácil manejo que permite cambiar rápidamente las boquillas de llenado.
- La tolva se puede inclinar a 90 grados para llenar, limpiar y desmontar.

- Fabriqué en acier inoxydable 18/10 de haute qualité.
- Rapide et efficace: conçu pour faire différents types de saucisses telles que les saucisses, les saucisses, les butifarras, etc.
- Grande capacité: idéal pour les bouchers, les restaurants et les cuisines industrielles.
- Double vitesse (lent / rapide) grâce à un mécanisme à deux vitesses entraîné par le roulement.
- Comprend 4 buses de remplissage en acier inoxydable: Ø38 mm, Ø32 mm, Ø22 mm et Ø16 mm.
- Écrou de liaison de manipulation facile qui vous permet de changer rapidement les buses de remplissage.
- La trémie peut être inclinée à 90 degrés pour remplir, nettoyer et se désassembler.

- Made of stainless steel 18/10 of high quality.
- Fast and effective: designed to make different types of sausages such as sausages, sausages, butifarras, etc.
- Great capacity: ideal for butchers, restaurants and industrial kitchens.
- Double speed (slow/fast) thanks to a two-speed mechanism driven by bearing.
- Includes 4 stainless steel filling nozzles: Ø38 mm, Ø32 mm, Ø22 mm and Ø16 mm.
- Easy handling binding nut that allows you to quickly change filling nozzles.
- The hopper can be tilted at 90 degrees to fill, clean and disassemble.

Clipadora

INOX

200
Grapas
Clips

Regulación de presión
Pressure adjustment



- Fabricada en acero inoxidable de máxima calidad.
- Diseñada para grapar embutidos, mallas de fruta, bolsas, etc. con el mínimo esfuerzo.
- Accionamiento manual fácil y muy cómodo.
- Sistema de apoyo de zamak macizo que garantiza una estabilidad máxima.
- Capacidad de grapas: 200 unidades (ref: 61201 - no incluidas).
- Fácil de limpiar.

- Fabriqué en acier inoxydable de qualité maximale.
- Conçu pour pomper des saucisses, des mailles de fruits, des sacs, etc. Avec l'effort minimum.
- Drive manuel facile et très confortable.
- Système de soutien Zamak solide qui garantit une stabilité maximale.
- Capacité temporaire: 200 unités (Réf: 61201 - Non incluse).
- Facile à nettoyer.

- Manufactured in maximum quality stainless steel.
- Designed to pump sausages, fruit meshes, bags, etc. With the minimum effort.
- Easy and very comfortable manual drive.
- Solid Zamak Support System that guarantees a maximum stability.
- Temporary capacity: 200 units (Ref: 61201 - Not included).
- Easy to clean.

GRAPAS · STAPLES
Ref: 61201
No incluidas · Not included

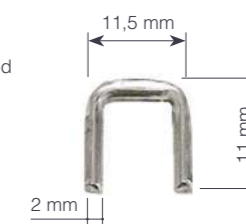

Clipadora

Clippeuse d'aliments · Lebensmittelacker
Food clipping machine · Agrafadora para alimentos

| Ref | € | cm | h(cm) | U.Venta |
|-------|--------|---------|-------|---------|
| 61200 | 307,70 | 37x15 | 58,5 | 1 |
| 61201 | 22,70 | 4,6 - 6 | - | 1 |

Grapas (4000 unid.)
Staples (set of 4000)

Centrifugadoras



PP
Polypropylene

Para uso profesional, sencillo y eficaz
For professional use, simple and efficient



Tapa accionamiento de giro
Turn drive cover



Centrifugadora Profesional

Essereuse à salade · Salatschleuder
Salad spinner drier · Centrifugadora professional

| Ref | € | Ø (cm) | h (cm) | L | U.Venta |
|-------|--------|--------|--------|------|---------|
| 61420 | 207,90 | 32 | 33 | 12,0 | 1 |
| 61425 | 231,80 | 42 | 40 | 25,0 | 1 |

Article non vendu en France



PP SAN
Polypropylene Plastic

Centrifugadora White

Essoreuse · Salatschleuder
Spinner · Centrifugadora

| Ref | € | Ø (cm) | h (cm) | L | U.Venta |
|-------|-------|--------|--------|------|---------|
| 61403 | 30,40 | 26 | 20,0 | 5,00 | 1 |



Centrifugadora Klein

Essoreuse · Salatschleuder
Spinner · Centrifugadora

| Ref | € | Ø (cm) | h (cm) | L | U.Venta |
|-------|-------|--------|--------|-----|---------|
| 61422 | 19,60 | 20,5 | 19,0 | 2,6 | 1 |

3 in 1
Centrifugadora
Essoreuse
Spinner
Escurreidor
Passoire
Colander
Ensaladera
Saladier
Salad bowl



700
r.p.m.



Aguja de mechar



Aguja de Mechar

Aiguille à larder · Spicknadel
Stuffing needle · Agulha de mechar

| Ref | € | Largo (cm) | U.Venta |
|-------|------|------------|---------|
| 61362 | 4,90 | 19 | 6 |



Jeringas y pipetas para cocina



• **Inyecta salsas o especias.**
• **Extrae la salsa para reducirla en la sartén.**

• Injecter des sauces ou des épices.
• Extraire la sauce pour la réduire dans la casserole.

• Inject sauces or spices.
• Extract the sauce to reduce it in the pan.



Jeringa para cocina

Seringue de cuisine · Spritze Küche
Kitchen syringe · Seringa para cozinha

| Ref | € | Largo (cm) | ml | Unidad | U.Venta |
|-------|------|------------|----|----------------|---------|
| 61418 | 6,20 | 21,5 | 30 | ml-oz-tsp-Tbsp | 6 |

Carnes y pescados más jugosos



• Su forma puntiaguda y alargada, permite abrir orificios fácilmente en la carne o pescado e insertar tiras de beicon, verduras, frutas, quesos o especias.
• Sistema de amarre con doble superficie dentada para una perfecta sujeción.
• Consigue carnes más sabrosas y pescados más jugosos.
• Apta para el lavavajillas.

• Sa forme pointue et allongée, vous permet d'ouvrir facilement des trous dans la viande ou le poisson et d'insérer des bandes de beicon, des légumes, des fruits, des fromages ou des épices.
• Système d'amarrage avec double dents pour un support parfait.
• Obtenez des viandes plus savoureuses et plus de poissons juteux.
• Convient au lave-vaisselle.

• Its pointed and elongated shape, allows you to open holes easily in meat or fish and insert beicon strips, vegetables, fruits, cheeses or spices.
• Mooring system with double teeth for a perfect support.
• Get tastier meats and more juicy fish.
• Suitable for dishwasher.



INOX

Pipeta para salsa

Poire à jus · Sossenspritze
Sauce syringe · Pipeta para molho

| Ref | € | Largo (cm) | ml | U.Venta |
|---------|-------|------------|----|---------|
| A 61408 | 18,10 | 30 | 40 | 1 |
| B 61416 | 13,20 | 30 | 40 | 1 |



Botellas biberon

PE LDPE
Polyethylene Polyethylene
BPA free

- Ideales para salsas, cremas, aceites, aliños, vinagretas y todo tipo de condimentos líquidos.
- Dibuja, adorna y personaliza con estilo tus platos.

- Idéal pour les sauces, les crèmes, les huiles, les assaisonnements, les vinaigrettes et tout type de condiments liquides.
- Il dessine, décore et personnalise les plats.

- Ideal for sauces, creams, oils, dressings, vinaigrettes and all kinds of liquid condiments.
- Draw, decorate and personalize your dishes with style.

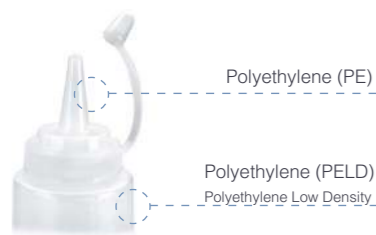

Polyethylene (PE)

Polyethylene (PELD)
Polyethylene Low Density

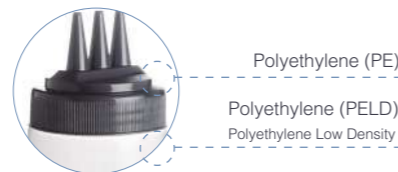

Polyethylene (PE)

Polyethylene (PELD)
Polyethylene Low Density

Botella biberón Tri
Bouteille biberon · Dosierflasche
Squeeze bottle · Garrafa

| Ref | € | Ø (cm) | L | U.Venta |
|-------|------|--------|------|---------|
| 61974 | 4,10 | 7x20 | 0,45 | 6 |
| 61977 | 4,40 | 7x26 | 0,70 | 6 |



Ideal para ketchup
Ideal for ketchup

Ideal para mostaza
Ideal for mustard

Botella biberon Push
Bouteille biberon · Dosierflasche
Squeeze bottle · Garrafa

| Ref | € | Ø (cm) | L | U.Venta |
|-------|------|--------|------|---------|
| 61978 | 4,60 | 6x20 | 0,50 | 1 |
| 61979 | 4,70 | 7x20 | 0,60 | 1 |
| 61980 | 4,90 | 7x26 | 0,70 | 1 |

Botella biberón
Bouteille biberon · Dosierflasche
Squeeze bottle · Garrafa

| Ref | € | Ø (cm) | L | U.Venta |
|--------|------|----------|------|---------|
| 61912 | 1,50 | 4x10 | 0,12 | 12 |
| 61925 | 1,60 | 5x19 | 0,25 | 12 |
| 61940 | 1,80 | 5,5x21,5 | 0,40 | 12 |
| 61970 | 2,00 | 7x26 | 0,70 | 12 |
| 61925R | 1,60 | 5x19 | 0,25 | 12 |
| 61940R | 1,80 | 5,5x21,5 | 0,40 | 12 |
| 61970R | 2,00 | 7x26 | 0,70 | 12 |
| 61925A | 1,60 | 5x19 | 0,25 | 12 |
| 61940A | 1,80 | 5,5x21,5 | 0,40 | 12 |
| 61970A | 2,00 | 7x26 | 0,70 | 12 |

SI
Silicone

Botella decoración
Biberon à decorer · Dekorierflasche
Decorating pen · Garrafa decoração

| Ref | € | Ø (cm) | L | U.Venta |
|-------|------|--------|------|---------|
| 64457 | 9,80 | 5,5x16 | 0,14 | 1 |



Dosificadores

INOX
18/10
Dishwasher

- Ideal para rellenar o decorar platos con salsas y cremas calientes y frías.
- Sistema de palanca para un caudal ajustable; práctico y preciso.
- Sistema antigoteo y antisalpicaduras.
- Mango con diseño ergonómico que permite el manejo con una sola mano.
- Fácil desmontaje para una sencilla limpieza. Apto para el lavavajillas.

- Idéal pour remplir ou décorer les plats avec des sauces et des crèmes chaudes et froides.
- Système de levier pour un débit réglable; pratique et précis.
- Système anti-tote et antisalpicaduras.
- Mango avec conception ergonomique qui permet de manipuler d'une seule main.
- Démontage facile pour un nettoyage simple. Compatible pour le lave-vaisselle.

- Perfect for filling or decorating dishes with hot or cold sauces and cream.
- Its lever system for controlling the flow is practical and precise.
- Anti-drip and anti-splash system.
- The ergonomic handle means it can be used with just one hand.
- It's easy to disassemble for easy cleaning and it's dishwasher safe.

SI PE
Silicone Polyethylene
BPA free

Dosificador Red
Entonnoir à decor · Dosierer
Portionner · Dosificador

| Ref | € | cm | h(cm) | L | U.Venta |
|-------|-------|-------|-------|-----|---------|
| 67026 | 12,10 | 16x11 | 18 | 1,0 | 1 |



Marcas de medición (ml - cup)
Measuring marks (ml - cup)

Sistema de gatillo para un caudal ajustable
Trigger system for an adjustable flow

3
Boquillas
Nozzles



Sistema de gatillo para un caudal ajustable
Trigger system for an adjustable flow

Incluye soporte y un platillo antigoteo
Includes support and a drip dish

3
Boquillas
Nozzles



Sistema de gatillo para un caudal ajustable
Trigger system for an adjustable flow

Incluye soporte
Includes support

Dosificador Inox
Entonnoir à decor · Dosierer
Portionner · Dosificador

| Ref | € | Ø (cm) | h(cm) | L | U.Venta |
|-------|-------|--------|-------|-----|---------|
| 67150 | 63,30 | 19 | 27 | 2,0 | 1 |

Dosificador Ration
Entonnoir à decor · Dosierer
Portionner · Dosificador

| Ref | € | L | U.Venta |
|-------|-------|------|---------|
| 67000 | 91,00 | 2,00 | 1 |

Sifones



Dishwasher

- **Robusto y duradero.**
- **Marcaje de llenado grabado en el exterior del cuerpo.**
- **Versátil: Diseñado para espumas frías y espumas calientes.**
- **Incluye 3 boquillas con formas decorativas.**
- **Funciona con cargas de gas (N2O).**
- **Cepillo limpiador para facilitar la limpieza.**

- Robuste et durable.
- Marquage de remplissage gravé à l'extérieur du corps.
- Versatile : conçu pour des préparations froides et chaudes.
- Inclut 3 douilles des formes décoratives.
- Fonctionne avec des cartouches de gaz (N2O).
- Brosse pour faciliter le nettoyage.

- Robust and durable.
- Embossed filling marks on the outside.
- Versatile: designed for whipping up hot or cold foams.
- Includes 3 nozzles with decorative shapes.
- Charged with gas cartridges (N2O).
- Cleaning brush for easy cleaning.

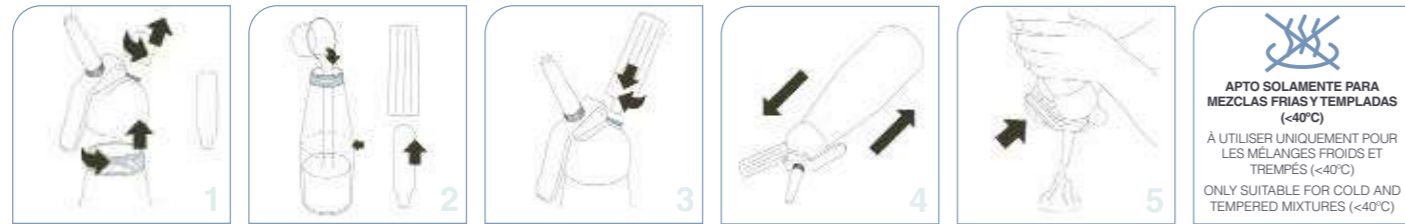

APTO SOLAMENTE PARA MEZCLAS FRÍAS Y TEMPLADAS (<40°C)
 À UTILISER UNIQUEMENT POUR LES MÉLANGES FROIDS ET TREMPÉS (<40°C)
 ONLY SUITABLE FOR COLD AND TEMPERED MIXTURES (<40°C)

EXCLUSIVAMENTE PARA USO ALIMENTICIO
 EXCLUSIVELY FOR FOOD USE



Cargas para sifón N2O

Charges de siphon N2O · Charges for N2O siphon ·

| Ref | € | Botellas | Peso (g) | U.Venta |
|-------|-------|----------|----------|---------|
| 68402 | 8,50 | 10 | 8 | 1 |
| 68403 | 19,90 | 24 | 8 | 1 |

Sifón Epicure

Siphon à crème · Sahnebereiter
 Cream whipper · Sifão creme

| Ref | € | Ø (cm) | L | U.Venta |
|-------|--------|--------|------|---------|
| 68300 | 111,00 | 9,0 | 0,50 | 1 |
| 68301 | 126,00 | 9,0 | 1,00 | 1 |

Temperatura de uso · Use temperature
 min = +5°C / max = +70°C



PBT plastic

Aluminium

Sifón White

Siphon à crème · Sahnebereiter
 Cream whipper · Sifão creme

| Ref | € | Ø (cm) | L | U.Venta |
|-------|-------|--------|------|---------|
| 68502 | 41,70 | 9x27 | 0,25 | 1 |
| 68500 | 49,40 | 9x31 | 0,50 | 1 |
| 68501 | 55,10 | 11x36 | 1,00 | 1 |

Temperatura de uso · Use temperature
 min = +5°C / max = +40°C

Sifón black

Siphon à crème · Sahnebereiter
 Cream whipper · Sifão creme

| Ref | € | Ø (cm) | L | U.Venta |
|-------|-------|----------|------|---------|
| 68604 | 52,10 | 7,8x27,3 | 0,50 | 1 |
| 68605 | 57,40 | 9,3x32,5 | 1,00 | 1 |

Temperatura de uso · Use temperature
 min = +5°C / max = +40°C



Inox 18/10

Inox 18/10



Aluminium

Inox

Sifón Mix

Siphon à crème · Sahnebereiter
 Cream whipper · Sifão creme

| Ref | € | Ø (cm) | L | U.Venta |
|-------|-------|----------|------|---------|
| 68404 | 85,00 | 7,8x25 | 0,50 | 1 |
| 68405 | 97,70 | 9,3x32,5 | 1,00 | 1 |

Temperatura de uso · Use temperature
 min = +5°C / max = +40°C



Ahumadores

AL

Aluminium Dishwasher



- **Técnica popular de la cocina creativa; otorga a los platos aromas especiales y personalizados.**
- **Perfecto para ahumar todo tipo de alimentos (carnes, pescados, quesos...).**
- **La construcción y su diseño facilitan la limpieza y el mantenimiento.**
- **Ideal para presentar y terminar platos delante del cliente.**
- **Incluye un set de filtros de recambio.**
- **Fácil de transportar gracias a su forma y tamaño.**
- **Pilas no incluidas.**
- *** Compatible con nuestras campanas de ahumado y la tapa.**

- Technique populaire de la cuisine créative; qui confère aux plats des arômes spéciaux et personnalisés.
- Parfait pour fumer tout type d'aliments (viandes, poissons, fromages...).
- La fabrication et la conception de chacune de ses parties facilite son nettoyage et son entretien.
- Idéal pour présenter et apporter la touche finale à des plats devant le client.
- Inclut un set de filtres de recharge.
- Facile à transporter grâce à sa forme et sa taille.
- Piles non incluses.
- * Compatible avec nos cloches de fumage et à couvercle.

- A popular creative cooking technique which gives dishes special and personalised aromas.
- Perfect for smoking all kinds of foods (meat, fish, cheeses...).
- The way it is designed and constructed makes it easy to clean and maintain.
- Ideal for presenting and finishing dishes in front of the customer.
- Includes a set of replacement filters.
- Easy to transport thanks to its shape and size.
- Batteries not included.
- * Compatible with our smoking cloches and the lid.



69221 - 69321
Incluyen bolsa de serrín (100 g)
 Wood Chips bag included (100 g)
Olivo · Olive

- **Permite ahumar dos platos a la vez, ahorrando tiempo.**
- **Incluye 2 mangueras de goma de 40 cm, 2 boquillas y un conector de conexión de mangueras.**

- Il permet de fumer deux plats à la fois, économisant ainsi du temps.
- Il comprend deux tuyaux en caoutchouc de 40 cm, deux embouts et un raccord de tuyaux.

- Two dishes can be smoked at once to save time.
- Two 40 cm rubber hoses, two nozzles and a hose connector included.



Ahumador de alimentos

Fumoir pour aliments · Apparat zum Räuchern von Lebensmitteln
 Food smoker · Defumador de alimentos

| Ref | € | U.Venta |
|---------|-------|---------|
| A 69221 | 44,90 | 1 |
| B 69321 | 60,20 | 1 |



Mangueras de goma flexible
 Flexible rubber hoses



Manguera doble para ahumador

Double tuyau pour fumoir · Doppelschlauch für Räucherapparat
 Double hoses for smoker · Manguera dupla para defumador

| Ref | € | Largo (cm) | U.Venta |
|-------|------|------------|---------|
| 69521 | 8,20 | 40 | 1 |

Campanas para ahumar

VIDRIO Glass
SI Silicone
Dishwasher

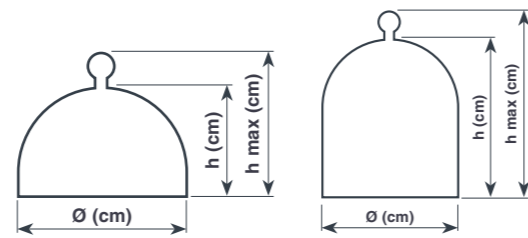
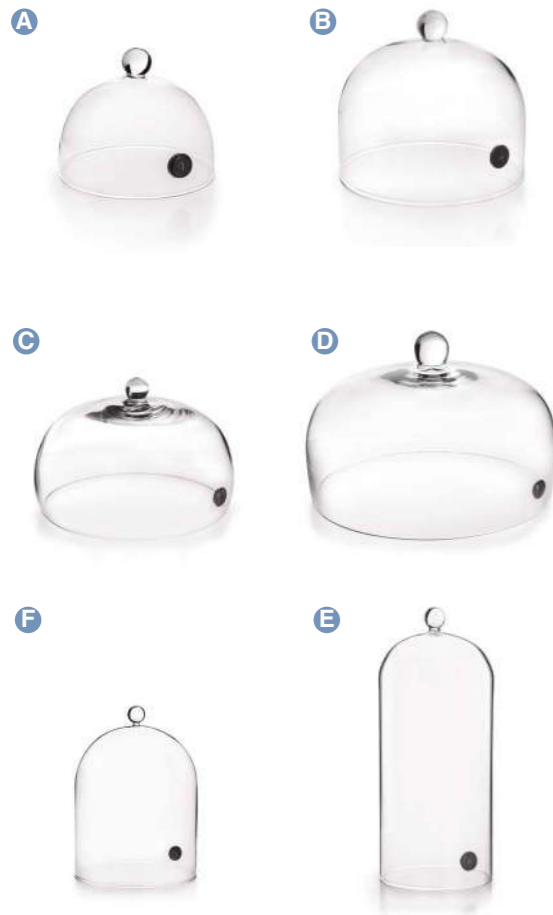

- Fabricada en cristal borosilicato de gran calidad. Es resistente a golpes, altas y bajas temperaturas.
- Permite la entrada de humo, vapor y aromas para ahumar o aromatizar alimentos sin tener que levantar la tapa.
- Cuenta con una válvula de inyección con autocierre de silicona (max. 200°C).
- Apta para microondas, horno y congelador.
- Complemento ideal para los ahumadores de alimentos Lacor.

- Fabriqué en cristal borosilicate de haute qualité. Il est résistant aux coups, à des températures élevées et basse.
- Il permet à l'entrée de la fumée, de la vapeur et des arômes de fumer ou d'aromatiser les aliments sans avoir à soulever le couvercle.
- Il a une soupape d'injection avec un auto-écrou en silicone (max. 200 °C).
- Convient au micro-ondes, au four et au congélateur.
- Complément idéal aux Ahumadores de la nourriture Lacor.

- Manufactured in high quality borosilicate crystal. It is resistant to blows, high and low temperatures.
- It allows the entry of smoke, steam and aromas to smoking or aromatizing food without having to lift the lid.
- It has an injection valve with Silicone Selfocierre (Max. 200°C).
- Suitable for microwave, oven and freezer.
- Ideal complement to Lacor food ahumadores.



- Tapa en forma de CD para crear un efecto hermético al momento de ahumar.
- Válido para todo tipo de envases, vasos, cocteleras, tarros, etc.
- Ideal para ahumar cócteles, destilados, comidas, quesos, etc.
- Válvula de inyección con autocierre de silicona (200°C).

- Couverture en forme de CD pour créer un effet hermétique lors du tabagisme.
- Valable pour tous les types de conteneurs, navires, cocktails, pots, etc.
- Idéal pour fumer des cocktails, des distillats, des repas, des fromages, etc.
- Vanne d'injection avec Silicone Autocierre (200 °C).

- CD-shaped cover to create a hermetic effect when smoking.
- Valid for all types of containers, vessels, cocktails, jars, etc.
- Ideal for smoking cocktails, distillates, meals, cheeses, etc.
- Injection valve with Silicone Autocierre (200°C).

Campana ahumador

Cloche à fumer · Räucherglocke
Smoker Hood · Campânula defumadora

| Ref | € | Ø (cm) | h(cm) | h max (cm) | U.Venta | |
|-----|-------|--------|-------|------------|---------|---|
| A | 61813 | 13,00 | 12,5 | 7,5 | 11,0 | 1 |
| B | 61815 | 21,30 | 16,0 | 12,0 | 15,0 | 1 |
| C | 61816 | 23,60 | 20,0 | 12,0 | 15,0 | 1 |
| D | 61817 | 40,30 | 25,0 | 14,0 | 17,0 | 1 |
| E | 61811 | 27,30 | 18,5 | 22,0 | 25,0 | 1 |
| F | 61812 | 32,50 | 12,5 | 26,5 | 30,0 | 1 |

Para cocteles
For cocktails

ASA Acrylic
SI Silicone

Tapa para ahumar

Chapeau de fumée · Rauchdeckel
Smoke cap · Tampa de fumaça

| Ref | € | Ø (cm) | U.Venta |
|-------|------|--------|---------|
| 69554 | 4,00 | 12 | 1 |

Serrín para ahumar



100 g



600 g

500 g

500 g

Serrín para ahumar

Scire de bois · Räuchermehl
Wood chips · Serrín de madeira

| Ref | € | g | U.Venta | |
|-------|------|-----|---------|-------------------|
| 69550 | 6,80 | 100 | 1 | Olivo · Olive |
| 69551 | 6,80 | 100 | 1 | Naranja · Orange |
| 69552 | 6,80 | 100 | 1 | Limonero · Lemon |
| 69553 | 6,80 | 100 | 1 | Almendra · Almond |
| 69559 | 6,80 | 100 | 1 | Whisky |
| 69560 | 6,80 | 100 | 1 | Cognac |
| 69555 | 9,20 | 600 | 1 | Olivo · Olive |
| 69556 | 9,20 | 600 | 1 | Naranja · Orange |
| 69557 | 9,20 | 600 | 1 | Limonero · Lemon |
| 69558 | 9,20 | 600 | 1 | Almendra · Almond |
| 69567 | 8,70 | 500 | 1 | Whisky |
| 69568 | 8,70 | 500 | 1 | Cognac |

Natural 100% Quality

La mejor elección para ahumar todo tipo de alimentos
The best choice to smoke all kinds of food

- Serrín especial de madera (99'9 % de pureza).
- Produce un humo denso y de alta calidad.
- Aporta un sabor muy suave aromatizado a los alimentos, gracias a una combustión lenta a baja temperatura.
- Cumple todas las normas y reglamentaciones existentes para el empleo con los alimentos.
- Compatible con el ahumador de alimentos de Lacor (ref. 69221 y ref: 69321).
- OLIVO: aporta a los alimentos un sabor suave y aromático.
- NARANJO: aporta a los alimentos un sabor dulce, afrutado y el frescor de los cítricos.
- LIMONERO: aporta a los alimentos un toque cítrico y dulce muy suave.
- ALMENDRO: aporta a los alimentos un aroma suave, dulce y floral de la almendra.
- WHISKY: aporta a los alimentos un aroma de barril de roble empleado para el reposo del Whisky
- COGNAC: aporta a los alimentos un aroma de barril de roble empleado para el reposo del Cognac.

- Special Wood Serrin (Pureté de 99'9%).
- Il produit une fumée dense et de haute qualité.
- Il offre une saveur très douce aromatisée aux aliments, grâce à une combustion lente à basse température.
- Il répond à toutes les normes et réglementations existantes pour la nourriture avec de la nourriture.
- Compatible avec la nourriture de Lacor Ahumador (réf. 69221 et réf: 69321).
- OLIVE: apporte aux aliments un goût doux, fruité et la fraîcheur des agrumes.
- ORANGE: apporte aux aliments un arôme délicat, doux et floral d'amande.
- CITRONNIER: apporte aux aliments une touche d'agrumes douce et très délicate.
- AMANDIER: apporte aux aliments un arôme délicat, doux et floral d'amande.
- WHISKY: apporte aux aliments un arôme de fut de chêne utilisée pour le vieillissement du whisky.
- COGNAC: apporte aux aliments un arôme de fut de chêne utilisée pour le vieillissement du cognac.

- Special Wood Serrin (99'9 % purity).
- It produces a dense and high quality smoke.
- It provides a very soft flavor aromatized to food, thanks to slow combustion at low temperature.
- It meets all existing standards and regulations for food with food.
- Compatible with Lacor's food ahumador (Ref. 69221 and REF: 69321).
- OLIVE: provides food a smooth and aromatic flavour.
- ORANGE: provides food a sweet, fruity taste and citrusy freshness.
- LEMON: provides food a very soft sweet citrusy touch.
- ALMOND: provides food with a soft, sweet, floral aroma of almonds.
- WHISKY: aromatic sawdust from the oak barrel used for ageing the whiskey.
- COGNAC: aromatic sawdust from the oak barrel used for ageing the cognac.

Medir y pesar
Measure and weigh

Jarras medidoras

INOX
18/10
Dishwasher



Jarra medidora Inox
Pot mesureur · Mass Behälter
Measuring jug · Jarra de medidas

| Ref | € | Ø (cm) | L | U.Venta |
|-------|-------|---------|------|---------|
| 62750 | 77,90 | 17x22,5 | 5,00 | 1 |

VIDRIO
Glass
Microwave



Jarra medidora Cristal
Pot mesureur · Mass Behälter
Measuring jug · Jarra de medidas

| Ref | € | L | U.Venta |
|-------|-------|-----|---------|
| 67133 | 11,30 | 0,5 | 1 |

PMMA
Plastic
BPA free



Vaso medidor Basic
Verre doseur · Messbecher
Measuring cup · Copo medidor

| Ref | € | Ø (cm) | h(cm) | L | U.Venta |
|-------|------|--------|-------|-----|---------|
| 67075 | 7,60 | 8,5 | 16,0 | 0,5 | 1 |
| 67071 | 9,90 | 10,5 | 19,0 | 1,0 | 1 |

PP
Polypropylene
BPA free



Jarras medidoras Pro
Pot mesureur · Mass Behälter
Measuring jugs · Jarras de medidas

| Ref | € | Ø (cm) | h(cm) | L | U.Venta |
|-------|-------|--------|-------|-----|---------|
| 67210 | 3,60 | 9,0 | 13,8 | 0,5 | 1 |
| 67211 | 4,70 | 12,0 | 17,0 | 1,0 | 1 |
| 67212 | 8,10 | 15,0 | 20,8 | 2,0 | 1 |
| 67213 | 10,60 | 17,0 | 23,5 | 3,0 | 1 |
| 67214 | 16,40 | 20,0 | 27,5 | 5,0 | 1 |

Jarra medidora
Couvercle · Deckel
Lid · Tampa



| Ref | € | Ø (cm) | h(cm) | L | U.Venta |
|-------|-------|--------|-------|-----|---------|
| 62742 | 26,50 | 15,0 | 17,0 | 2,0 | 1 |
| 62741 | 22,40 | 11,5 | 13,0 | 1,0 | 1 |

SAN
Plastic
BPA free



Set 3 jarras medidoras Tri
Ensemble de 3 pot mesureur · 3-tlg. Satz Messbecher
3 piece measuring jugs · Jogo 3 jarras de medidas

| Ref | € | L | U.Venta |
|-------|-------|------|---------|
| 67131 | 15,60 | 0,25 | 1 |
| | | 0,5 | |
| | | 1,0 | |

PP
Polypropylene
BPA free



Set 3 jarras medidoras
Set 3 pichets doseurs · Messbecher, 3 Er-Setr
Set of 3 measuring jugs · Conjunto 3 jarras medidas

| Ref | € | Ø (cm) | h(cm) | L | U.Venta |
|-------|------|--------|-------|------|---------|
| 67130 | 9,40 | 9,5 | 8,5 | 0,25 | 1 |
| | | 11,0 | 10,0 | 0,50 | |
| | | 13,0 | 11,5 | 1,00 | |

PP
Polypropylene
BPA free



Set 5 jarras medidoras Pro
Setn 5 pichets doseurs · Messbecher, 5 Er-Setr
Set of 5 measuring jugs · Conjunto 5 jarras medidas

| Ref | € | cm | h(cm) | L | U.Venta |
|-------|-------|-------|-------|-----|---------|
| 67215 | 41,00 | 15x9 | 15,3 | 0,5 | 1 |
| | | 18x11 | 18,8 | 1,0 | |
| | | 22x15 | 23,0 | 2,0 | |
| | | 24x17 | 26,0 | 3,0 | |
| | | 27x20 | 30,2 | 5,0 | |

Set medición Exact

Set 4 boles Practic

Set 6 boles Multi

Boles Inox

ASA Acrylic PS Plastic Dishwasher BPA free

PP Polypropylene Dishwasher BPA free

PP Polypropylene Dishwasher BPA free

INOX Polypropylene Dishwasher BPA free



- Todas las piezas fabricadas en materiales de máxima calidad, libres de BPA.
- Versátil. Ideal para ingredientes líquidos y secos.
- Jarra con sistema de lectura rápida en litros y cups. Permite comprobar el nivel del líquido mientras se está vertiendo el contenido.
- Cazos marcados en ml y bps para una rápida identificación.

- Tous les pièces en matériaux de qualité maximale, sans BPA.
- Polyvalent. Idéal pour les ingrédients liquides et secs.
- Jug avec système de lecture rapide en litres et tasses. Il permet de vérifier le niveau du liquide pendant que le contenu coule.
- Économise marquée en ML et BPS pour une identification rapide.

- All pieces made of maximum quality materials, BPA free.
- Versatile. Ideal for liquid and dry ingredients.
- Jug with fast reading system in liters and cups. It allows to check the level of the liquid while the content is pouring.
- Saves marked in ML and BPS for rapid identification.

Raspador · Scraper

6 cazos medidores

6 measuring cups
(7,5 ml, 15 ml, 60 ml,
85 ml, 125 ml, 250 ml)

Embudo · Funnel

Jarra medidora
Measuring jug
(1,0 L / 4 cups)

Compacto · Compact



- Práctico y versátil.
- Fabricados en polipropileno de máxima calidad. 100% Libre de BPA.
- Jarras medidoras graduadas (mililitros/cups).
- Pequeño vertedor lateral para facilitar el vertido.
- Asas ergonómicas para facilitar el transporte.
- 100% estable gracias a los pies antideslizantes.
- Apilables; ocupan el mínimo espacio posible.
- Aptos para el lavavajillas.

- Pratique et polyvalent.
- Fabriqué en polypropylène de qualité maximale. 100% BPA gratuit.
- Pailles de compteur gradué (millilitres / tasses).
- Petit décharge latérale pour faciliter la décharge.
- Poignées ergonomiques pour faciliter le transport.
- 100% stable grâce aux pieds non glissants.
- Empilable; Ils occupent l'espace minimum possible.
- Apte pour le lave-vaisselle.

- Practical and versatile.
- Manufactured in maximum quality polypropylene. 100% BPA free.
- Graduated meter jugs (milliliters/cups).
- Small lateral dump to facilitate discharge.
- Ergonomic handles to facilitate transportation.
- 100% stable thanks to non-slip feet.
- Stackable; They occupy the minimum possible space.
- Apt for the dishwasher.

Jarra medidora
Measuring jug (0,5 L)

Jarra medidora
Measuring jug (1,0 L)

Apilables · Stackable

Escurridor
Colander (2,0 L)

Bol mezclador
Mixing bowl (3,5 L)

Set de 4 boles Practic

Ensemble de 4 récipients · Schüsseln, 4er-Set
Set of 4 bowls · Conjunto de 4 tigelas

| Ref | € | Ø (cm) | h(cm) | L | U.Venta |
|-------|-------|--------|-------|-----|---------|
| 62633 | 36,10 | 11,5 | 9,3 | 0,5 | 1 |
| | | 14,5 | 10,6 | 1,0 | |
| | | 18,5 | 13,0 | 2,0 | |
| | | 22,0 | 15,0 | 3,5 | |

Set de medición Exact

Set de mesure · Messbecher-Set
Measuring set · Conjunto de medição

| Ref | € | cm | h(cm) | U.Venta |
|-------|-------|-------|-------|---------|
| 62740 | 16,40 | 20x11 | 13,6 | 1 |

- Set de 6 boles de polipropileno de máxima calidad, 100% libres de BPA.
- Versátiles: ideales para mezclar, batir, preparar masas, servir ensaladas o salsas.
- Compuesto por 6 boles perfectamente apilables entre sí.
- Incluye 6 tapas fabricadas en polipropileno, libres de BPA.
- Perfectos para almacenar y conservar los alimentos.
- Fácil limpieza. Cuerpos aptos para el lavavajillas.

- Ensemble de 6 bols en polypropylène de qualité maximale, 100% exempts de BPA.
- Polyvyle: idéal pour mélanger, battre, préparer des masses, servir des salades ou des sauces.
- Composé de 6 boudes parfaitement empilables les uns aux autres.
- Comprend 6 couvertures fabriquées en polypropylène, sans BPA.
- Parfait pour stocker et conserver la nourriture.
- Nettoyage facile. Corps adaptés au lave-vaisselle.

- Set of 6 polypropylene bowls of maximum quality, 100% free of BPA.
- Versatile: Ideal to mix, beat, prepare masses, serve salads or sauces.
- Composed of 6 bowls perfectly stackable to each other.
- Includes 6 covers manufactured in polypropylene, BPA free.
- Perfect to store and conserve food.
- Easy cleaning. Dishwasher safe bodies.

Cuerpos aptos para el lavavajillas
Dishwasher safe bodies

Set 6 boles Multi

Ensemble de 6 récipients · Schüsseln, 6er-Set
Set of 6 bowls · Conjunto de 6 tigelas

| Ref | € | Ø (cm) | h(cm) | L | U.Venta |
|-------|-------|--------|-------|------|---------|
| 60055 | 20,50 | 10,0 | 5,0 | 0,25 | 1 |
| | | 14,0 | 6,8 | 0,80 | |
| | | 17,0 | 8,0 | 1,15 | |
| | | 20,3 | 9,5 | 2,00 | |
| | | 24,3 | 11,0 | 3,35 | |
| | | 28,3 | 12,5 | 5,25 | |

Set 3 boles Inox

Ensemble de 3 récipients · Schüsseln, 3er-Set
Set of 3 bowls · Conjunto de 3 tigelas

| Ref | € | Ø (cm) | h(cm) | L | U.Venta |
|-------|-------|--------|-------|-----|---------|
| 60050 | 33,30 | 16 | 10,0 | 1,5 | 1 |
| | | 18 | 11,0 | 2,2 | |
| | | 20 | 12,5 | 3,0 | |
| 60051 | 44,90 | 20 | 12,5 | 3,0 | 1 |
| | | 22 | 13,5 | 3,8 | |
| | | 24 | 14,0 | 4,0 | |

garinox®

Bol Cónico Garinox

Bol conique · Schüssel, konisch
Conical mixing bowl · Bacia cônica

| Ref | € | Ø (cm) | h(cm) | L | U.Venta |
|-------|-------|--------|-------|-------|---------|
| 14016 | 3,90 | 16 | 6,5 | 0,90 | 12 |
| 14019 | 5,30 | 20 | 7,5 | 1,40 | 12 |
| 14025 | 9,70 | 24 | 9,0 | 2,50 | 1 |
| 14029 | 13,20 | 30 | 11,0 | 4,30 | 1 |
| 14033 | 18,30 | 34 | 13,5 | 7,50 | 1 |
| 14040 | 23,30 | 40 | 15,5 | 11,50 | 1 |
| 14046 | 33,10 | 45 | 17,5 | 17,40 | 1 |
| 14049 | 38,80 | 50 | 19,0 | 22,60 | 1 |

Calderos

INOX 18/10
Dishwasher



Caldero semiesférico sin asas

Bassine hemispherique s/anses · Schneeschlagkessel ohne Griffe
Semi-spherical mixing bowl w/out/handles · Bacia semi-esférica sem asas

Caldero semiesférico con asas

Bassine hemispherique a/anses · Schneeschlagkessel mit Griffe
Semi-spherical mixing bowl w/handles · Bacia semi-esférica com asas

| Ref | € | Ø (cm) | h(cm) | L | U.Venta |
|--------|--------|--------|-------|-------|---------|
| 50323S | 37,50 | 22 | 11,0 | 2,70 | 1 |
| 50327S | 43,80 | 26 | 13,0 | 4,00 | 1 |
| 50333S | 58,80 | 32 | 17,0 | 9,50 | 1 |
| 50337S | 66,70 | 36 | 18,0 | 12,00 | 1 |
| 50341S | 111,90 | 40 | 21,0 | 14,50 | 1 |
| 50300 | 26,40 | - | - | - | 1 |

| Ref | € | Ø (cm) | h(cm) | L | U.Venta |
|-------|--------|--------|-------|-------|---------|
| 50323 | 49,40 | 22 | 11,0 | 2,70 | 1 |
| 50327 | 56,20 | 26 | 13,0 | 4,00 | 1 |
| 50333 | 72,20 | 32 | 17,0 | 9,50 | 1 |
| 50337 | 77,70 | 36 | 18,0 | 12,00 | 1 |
| 50341 | 111,10 | 40 | 21,0 | 14,50 | 1 |
| 50300 | 26,40 | - | - | - | 1 |



Caldero cónico

Bassine conique · Wanne
Mixing bowl · Bacia cónica

Caldero cónico con asas

Bassine conique à anses · Wanne mit Griffe
Conical mixing bowl · Bacia cónica con asas

| Ref | € | Ø (cm) | h(cm) | L | U.Venta |
|-------|-------|--------|-------|-------|---------|
| 60013 | 12,70 | 13 | 6,1 | 0,55 | 1 |
| 60016 | 13,80 | 16 | 9,1 | 1,00 | 1 |
| 60020 | 18,90 | 20 | 11,7 | 2,12 | 1 |
| 60024 | 22,70 | 24 | 12,6 | 3,50 | 1 |
| 60028 | 28,40 | 28 | 13,4 | 5,25 | 1 |
| 60032 | 31,90 | 32 | 15,0 | 7,65 | 1 |
| 60036 | 44,10 | 36 | 16,0 | 11,00 | 1 |
| 60040 | 51,20 | 40 | 18,0 | 15,00 | 1 |

| Ref | € | Ø (cm) | h(cm) | L | U.Venta |
|-------|-------|--------|-------|-------|---------|
| 50828 | 44,30 | 28 | 13,2 | 5,00 | 1 |
| 50832 | 49,10 | 32 | 14,5 | 7,00 | 1 |
| 50836 | 56,20 | 36 | 16,0 | 11,00 | 1 |
| 50840 | 62,50 | 40 | 18,0 | 15,00 | 1 |
| 50845 | 74,60 | 45 | 20,0 | 22,00 | 1 |
| 50850 | 89,50 | 50 | 21,0 | 30,00 | 1 |

garinox®



Cubo Garinox

Seau · Eimer
Pail · Balde

| Ref | € | Ø (cm) | h(cm) | L | U.Venta |
|-------|-------|---------|-------|-------|---------|
| 14114 | 9,60 | 16-12 | 15,5 | 1,40 | 1 |
| 14119 | 18,10 | 20-15 | 20,0 | 4,60 | 1 |
| 14124 | 22,50 | 24-17,2 | 20,5 | 5,60 | 1 |
| 14128 | 40,90 | 28-21 | 25,8 | 14,00 | 1 |

Cazo servir Pochon

Pochon · Suppenkelle "Pochon" (Für server)
Pochon soup ladle for server · Caçarole servir "Pochon"

| Ref | € | Ø (cm) | Largo (cm) | L | U.Venta |
|-------|-------|--------|------------|------|---------|
| 60520 | 61,30 | 20 | 42,5 | 2,00 | 1 |



Etern

INOX 18/10

CRISTAL Glass
Oven Microwave Freezer Dishwasher BPA free

- Recipiente de acero inoxidable 18/10 apto para el microondas.
- Tapa de cristal con válvula para dejar circular el aire.
- ClipLock System: Los 4 cierres de clip sujetan firmemente la tapa asegurando su estanqueidad.
- 100% hermético: Gracias a la junta de silicona extraíble que incorpora la tapa.
- Ligeros y resistentes: ideales para guardar alimentos y transportar la comida a cualquier lugar.
- Higiénicos y antibacterianos: No transmiten olores ni sabores a los alimentos.
- Recipientes apto para el microondas, el horno (sin tapa), el lavavajillas, el frigorífico y el congelador.
- Apilables: ahorra espacio en la cocina.
- Ecológicos, reutilizables y libre de BPA.

- Récipient en acier inoxydable 18/10 apte pour le micro-ondes.
- Couvercle en verre avec valve pour laisser circuler l'air.
- ClipLock System : Les 4 clips de fermeture tiennent fermement le couvercle, garantissant ainsi son étanchéité.
- 100% hermétique : Grâce au joint en silicone extractible que possède le couvercle.
- Léger et résistant : Idéal pour ranger les aliments et transporter la nourriture partout.
- Hygiénique et antibactérien : Ne transmet ni odeurs ni goûts aux aliments.
- Récipient apte pour le micro-ondes, le four (sans couvercle), le lave-vaisselle, le réfrigérateur et le congélateur.
- Empilable : gain de place dans la cuisine.
- Écologique, réutilisable et sans BPA.

- 18/10 stainless steel container suitable for the microwave.
- Glass lid with valve for air circulation.
- ClipLock System: the 4 clip locks hold the lid securely in place, ensuring water tightness.
- 100% leak-proof due to the removable silicone gasket in the lid.
- Lightweight and robust: perfect for storing food and taking it wherever you want to go.
- Hygienic and antibacterial: does not transmit odours or flavours.
- Microwave, oven (without lid), dishwasher, fridge and freezer safe container and lid.
- Stackable: space saving in the kitchen.
- Eco-friendly, reusable and BPA-free.



Recipiente rectangular

Récipient rectangulaire · Rechteckbehälter
Rectangular container · Recipiente rectangular

| Ref | € | ml | cm | h(cm) | U.Venta |
|-------|-------|------|-----------|-------|---------|
| 64608 | 11,00 | 480 | 15,5x11,5 | 5,8 | 1 |
| 64600 | 11,40 | 800 | 18x13,5 | 7,0 | 1 |
| 64601 | 13,00 | 1250 | 20,5x15,5 | 7,5 | 1 |
| 64602 | 16,10 | 1800 | 23x17,5 | 8,0 | 1 |
| 64609 | 11,70 | 820 | 20x15 | 5,0 | 1 |

Recipiente cuadrado

Récipient carré · Quadratischer Behälter
Square container · Recipiente quadrado

| Ref | € | ml | cm | h(cm) | U.Venta |
|-------|-------|------|-----------|-------|---------|
| 64603 | 10,10 | 650 | 14x14 | 7 | 1 |
| 64604 | 14,20 | 1500 | 18,5x18,5 | 8 | 1 |



Recipiente redondo

Récipient rond · Runder Behälter
Round container · Recipiente redondo

| Ref | € | ml | cm | h(cm) | U.Venta |
|-------|-------|------|-------|-------|---------|
| 64605 | 10,30 | 700 | 16x16 | 6,5 | 1 |
| 64606 | 14,70 | 1500 | 20x20 | 7,5 | 1 |

Set 3 recipientes

Set de 3 récipients · Set mit 3 Behältern
Set with 3 containers · Conjunto com 3 recipientes

| Ref | € | ml | cm | h(cm) | U.Venta |
|-------|-------|------|-----------|-------|---------|
| 64607 | 39,80 | 800 | 18x13,5 | 7 | 1 |
| | | 1200 | 20,5x15,5 | 7,5 | |
| | | 1800 | 23x17,5 | 8 | |



Ecoinox

INOX 18/10 **PP** Polypropylene

- Recipiente de acero inoxidable 18/10 apto para el microondas.
 - Tapa de polipropileno.
 - **ClipLock System: Los 4 cierres de clip sujetan firmemente la tapa asegurando su estanqueidad.**
 - **100% hermético: Gracias a la junta de silicona extraíble que incorpora la tapa.**
 - **Ligeros y resistentes: ideales para guardar alimentos y transportar la comida a cualquier lugar.**
 - **Higiénicos y antibacterianos: No transmiten olores ni sabores a los alimentos.**
 - **Recipientes apto para el microondas y el horno. Recipientes y tapas aptos para el lavavajillas, el frigorífico y el congelador.**
 - **Apilables: ahorra espacio en la cocina.**
 - **Ecológicos, reutilizables y libre de BPA.**
- Récipient en acier inoxydable 18/10 apte pour le micro-ondes.
 - Couvercle en polypropylène.
 - ClipLock System : Les 4 clips de fermeture tiennent fermement le couvercle, garantissant ainsi son étanchéité.
 - 100% hermétique : Grâce au joint en silicone extractible que possède le couvercle.
 - Léger et résistant : Idéal pour ranger les aliments et transporter la nourriture partout.
 - Hygiénique et antibactérien : Ne transmet ni odeurs ni goûts aux aliments.
 - Récipient apte pour le micro-ondes et le four. Récipient et couvercle aptes pour le lave-vaisselle, le réfrigérateur et le congélateur.
 - Empilable : gain de place dans la cuisine.
 - Écologique, réutilisable et sans BPA.
- 18/10 stainless steel container suitable for the microwave.
 - Polypropylene lid.
 - ClipLock System: the 4 clip locks hold the lid securely in place, ensuring water tightness.
 - 100% leak-proof due to the removable silicone gasket in the lid.
 - Lightweight and robust: perfect for storing food and taking it wherever you want to go.
 - Hygienic and antibacterial: does not transmit odours or flavours.
 - Microwave and dishwasher safe.
 - Dishwasher, fridge and freezer safe container and lid.
 - Stackable: space saving in the kitchen.
 - Eco-friendly, reusable and BPA-free.



Recipiente rectangular

Récipient rectangulaire · Rechteckbehälter
Rectangular container · Recipiente rectangular

| Ref | € | ml | cm | h(cm) | U.Venta |
|-------|-------|------|-----------|-------|---------|
| 64622 | 6,60 | 260 | 12,7x9 | 5,1 | 1 |
| 64618 | 8,20 | 480 | 15,5x11,5 | 5,8 | 1 |
| 64610 | 8,80 | 800 | 18x13,5 | 7,0 | 1 |
| 64611 | 10,90 | 1250 | 20,5x15,5 | 7,5 | 1 |
| 64612 | 13,60 | 1800 | 23x17,5 | 8,0 | 1 |
| 64619 | 9,20 | 820 | 20x15 | 5,0 | 1 |

Recipiente cuadrado

Récipient carré · Quadratischer Behälter
Square container · Recipiente quadrado

| Ref | € | ml | cm | h(cm) | U.Venta |
|-------|-------|------|-----------|-------|---------|
| 64613 | 8,20 | 650 | 14x14 | 7 | 1 |
| 64614 | 11,70 | 1500 | 18,5x18,5 | 8 | 1 |

Recipiente redondo

Récipient rond · Runder Behälter
Round container · Recipiente redondo

| Ref | € | ml | cm | h(cm) | U.Venta |
|-------|-------|------|-------|-------|---------|
| 64615 | 8,40 | 700 | 16x16 | 6,5 | 1 |
| 64616 | 12,60 | 1500 | 20x20 | 7,5 | 1 |

Set 3 recipientes

Set de 3 recipientes · Set mit 3 Behältern
Set with 3 containers · Conjunto com 3 recipientes

| Ref | € | ml | cm | h(cm) | U.Venta |
|-------|-------|----------|-----------|-------|---------|
| 64623 | 19,40 | 260 (x3) | 12,7x9 | 5,1 | 1 |
| 64617 | 32,20 | 800 | 18x13,5 | 7 | 1 |
| | | 1200 | 20,5x15,5 | 7,5 | |
| | | 1800 | 23x17,5 | 8 | |



Recipiente TwoGo

new

INOX 18/10 **AS** Plastic

- **Recipiente de acero inoxidable 18/10 con dos compartimentos apto para el microondas. Tapa de plástico AS.**
 - **ClipLock System: los 4 cierres de clip sujetan firmemente la tapa asegurando su estanqueidad.**
 - **100% hermético: gracias a la junta de silicona extraíble que incorpora la tapa.**
 - **Ligero y resistente: ideal para guardar alimentos y transportar la comida a cualquier lugar.**
 - **Higiénico y antibacteriano: no transmite olores ni sabores a los alimentos.**
 - **Recipiente apto para el microondas y el horno. Recipiente y tapa aptos para el lavavajillas, el frigorífico y el congelador.**
 - **Ecológico, reutilizable y libre de BPA.**
- Récipient en acier inoxydable 18/10 avec deux compartiments allant au micro-ondes. Couvercle en plastique AS.
 - ClipLock System : les 4 clips de fermeture tiennent fermement le couvercle, garantissant ainsi son étanchéité.
 - 100% hermétique : grâce au joint en silicone extractible que possède le couvercle.
 - Léger et résistant : idéal pour ranger les aliments et transporter la nourriture partout.
 - Hygiénique et antibactérien : ne transmet ni odeurs ni goûts aux aliments.
 - Récipient apte pour le micro-ondes et le four. Récipient et couvercle aptes pour le lave-vaisselle, le réfrigérateur et le congélateur.
 - Écologique, réutilisable et sans BPA.
- 18/10 stainless steel container with two microwave-safe compartments. AS plastic lid.
 - ClipLock System: the 4 clip locks hold the lid securely in place, ensuring water tightness.
 - 100% leak-proof due to the removable silicone gasket in the lid.
 - Lightweight and robust: perfect for storing food and taking it wherever you want to go.
 - Hygienic and antibacterial: does not transmit odours or flavours.
 - Microwave and dishwasher safe.
 - Dishwasher, fridge and freezer safe container and lid.
 - Eco-friendly, reusable and BPA-free.



Recipiente TwoGo

Récipient · Behälter
Container · Recipiente

| Ref | € | cm | h (cm) | ml | U.Venta |
|-------|-------|-----------|--------|---------|---------|
| 64620 | 12,80 | 21,7x16,6 | 5,5 | 450-280 | 1 |

Básculas profesionales



Cabezal orientable y abatible
Retractable, swivelling head

Cuerpo aluminio fundido
Cast aluminium case

Plataforma inoxidable 53x44cm
St. Steel platform, 53x44 cm

Plataforma inoxidable 30x24 cm
Plataforma extraíble
Doble display (Delante / Detrás)
Teclado intuitivo y de fácil uso
Patas de apoyo regulables

St. Steel platform, 30x24 cm
Removable platform
Double display (Front / Back)
Intelligent and easy-to-use keyboard
Adjustable support feet



Báscula profesional electrónica

Balance électronique professionnelle · Elektronische Profi-Waagen
Electronic professional scale · Balança eletrônica profissional

| Ref | € | W | Tara | IP | Peso (Kg) | U.Venta |
|-------|--------|-------|----------|--------|-----------|---------|
| 61716 | 485,10 | 0,2 W | 15kg/5g | IPX 54 | 4,60kg | 1 |
| 61730 | 522,00 | 0,2 W | 30kg/10g | IPX 54 | 4,60 kg | 1 |

CERTIF.: OIML R76 Clase III, 60/384/ECC

- **Báscula portátil con indicador luminoso externo.**
- **Plataforma fabricada en acero inoxidable de gran resistencia (medidas: 30x25,5cm)**
- **Capacidad máxima de pesada de 180 kg y 0,01 kg de resolución.**
- **Dos modos de alimentación, por red 220V con cargador de corriente incluido o 2 pilas AAA.**
- **Función cero y función tara. Tres unidades de peso: kg, libras, onzas.**
- **Display luminoso externo. Proporciona lecturas instantáneas y precisas.**
- **Apagado automático cuando funciona con pilas.**
- **Máxima estabilidad: pies de goma antideslizantes.**

- Balance portable avec indicateur lumineux externe.
- Plateforme fabriquée en acier inoxydable de grande résistance (dimensions : 30x25,5cm)
- Capacité maximum de pesée de 180 kg et 0,01 kg de résolution.
- Deux modes d'alimentation : sur secteur 220V avec chargeur inclus ou avec piles (2 piles AAA non fournies)
- Fonction zéro et fonction tare. Trois unités de poids : kg, livres, onces.
- Affichage lumineux externe. Fournit des lectures instantanées et précises.
- Arrêt automatique en cas de fonctionnement sur piles.
- Stabilité maximale : pieds en caoutchouc antidérapants.

- Portable scale with external indicator light.
- Platform made of highly resistant stainless steel (measures: 30x25,5cm).
- Maximum weighing capacity of 180 kg and 0.01 kg resolution.
- Two power supply modes, 220V mains with power charger included or 2 AAA batteries.
- Zero function and tare function. Three weight units: kg, pounds, ounces.
- External illuminated display. Provides instant and accurate readings.
- Automatic shut-off when battery operated.
- Maximum stability: non-slip rubber feet.

Báscula plataforma

Balance à plateforme · Plattformwaage
Platform scales · Balança de plataforma

| Ref | € | cm | Peso (Kg) | División (g) | Unidad | U.Venta |
|-------|-------|---------|-----------|--------------|-------------|---------|
| 61724 | 69,90 | 30x25,5 | 180 | 0,01 | kg/lb/lb.oz | 1 |

Básculas de cocina electrónicas



- **Básculas perfectas para cualquier cocina.**
- **Función tara.**
- **Reseteo automático a cero.**
- **Pantalla LCD, fácil lectura de los resultados.**
- **Función de apagado automático, ahorrar energía.**
- **Indicador de batería baja y sobrecarga.**

- Balances parfaites pour toutes les cuisines.
- Fonction tare.
- Mise à zéro automatique.
- Écran LCD, lecture facile des résultats.
- Fonction d'arrêt automatique pour permettre des économies d'énergie.
- Indicateur de batterie faible et de surcharge.

- This scales is perfect for any kitchen.
- Tare function.
- Automatic reset to zero.
- LCD screen with easy to read results.
- Automatic shut-off to save energy.
- It has a low battery and overload indicator.

4 sensores de alta precisión
Four high precision sensors



Plataforma de bambú
Bamboo platform



Báscula de cocina Eben

Balance de cuisine · Küchenwaage
Kitchen scale · Balança de cozinha

| Ref | € | cm | División (g) | Unidad | Peso (Kg) | U. Venta |
|-------|-------|-------------|--------------|---------------|-----------|----------|
| 61717 | 56,20 | 31x25,6x2,5 | 1 | g/Kg/oz/lb.oz | 15 | 1 |

Báscula de cocina Bamboo

Balance de cuisine · Küchenwaage
Kitchen scale · Balança de cozinha

| Ref | € | cm | División (g) | Unidad | Peso (Kg) | U. Venta |
|-------|-------|---------------|--------------|------------------|-----------|----------|
| 61712 | 24,40 | 21,8x18,8x2,1 | 1 | g/ml/lb/oz/fl-oz | 5 | 1 |

Plataforma de cristal
Glass platform



Báscula de cocina Slim

Balance de cuisine · Küchenwaage
Kitchen scale · Balança de cozinha

| Ref | € | cm | División (g) | Unidad | Peso (Kg) | U.Venta |
|-------|-------|---------|--------------|--------------|-----------|---------|
| 61708 | 28,10 | 27x18x4 | 1 | g/oz/ml/cups | 5 | 1 |

Báscula de cocina Round

Balance de cuisine · Küchenwaage
Kitchen scale · Balança de cozinha

| Ref | € | cm | División (g) | Peso (Kg) | U.Venta |
|-------|-------|---------|--------------|-----------|---------|
| 61703 | 61,80 | 15,5x12 | 1 | 5 | 1 |

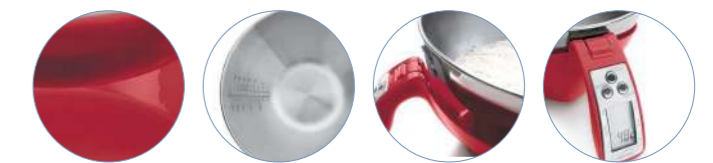

Plataforma de cristal
Glass platform



INOX

Báscula de cocina Cristal

Balance de cuisine · Küchenwaage
Kitchen scale · Balança de cozinha

| Ref | € | Peso (Kg) | División (g) | U.Venta |
|-------|-------|-----------|--------------|---------|
| 61725 | 23,20 | 5 | 1 | 1 |

Báscula de cocina con bol extraíble

Balance numérique avec bol amovible · Digitalwaage mit abnehmbarer Schale
Scale digital with removable bowl · Balança digital con bacia removível

| Ref | € | Ø (cm) | L | Peso (Kg) | División (g) | U.Venta |
|-------|-------|----------|------|-----------|--------------|---------|
| 61707 | 37,90 | 21 (bol) | 1,50 | 5 | 1 | 1 |

new



Plataforma de acero inoxidable
Stainless steel platform

DUAL
Dos superficies de pesaje
Two weighing surfaces

INOX

Báscula digital ultraprecisión Doble

Balance digitale ultra-précision double · Sehr präzise küchenwaage dual digital
High precision dual platform digital scales · Balança digital dupla de ultraprecisão

| Ref | € | cm | Peso (Kg) | División (g) | Unidades | U. Venta |
|-------|-------|-------|-----------|--------------|----------------------------|----------|
| 61726 | 49,50 | 24x20 | 15 | 1 | g (kg) / oz / ml (agua-ml) | 1 |

- Báscula de alto rendimiento con un diseño de doble plataforma fabricada en acero inoxidable.
- Dos superficies de pesaje ultra precisos, una pesa hasta 15 kg (1 g) y la otra hasta 1 kg (0,05 g).
- Equipado con un sistema de sensores de galgas extensométricas de alta precisión.
- Pantalla retroiluminada que facilita la lectura de los números.
- Encendido/apagado manual. Apagado automático. Reinicio automático.
- Función Tara. Función de bloqueo de peso para la báscula principal.
- Unidades: g (kg) / oz / ml (agua-ml).
- Indicación de baja potencia / sobrecarga.
- Alimentación: 3 pilas AAA de 1,5 V (incluidas).
- Tamaño compacto: fácil de almacenar y utilizar en cualquier lugar.
- Medidas de la báscula: 24x20 cm / Plataforma grande: 22x16 cm / Plataforma pequeña: 19,5x13,5 cm.

- High performance stainless steel dual platform scales.
- Two ultra-precise weighing surfaces: one for weighing up to 15 kg (1 g) and the other for up to 1 kg (0.05 g).
- Equipped with a high precision strain gauge sensor system.
- Backlit display for easy reading of numbers.
- Manual on/off switch. Auto power-off function. Auto restart function.
- Tare mode. Weight lock function for the main scales.
- Units: g (Kg) / oz / ml (water ml).
- Low power / overload indication.
- Power supply: 3 x 1.5 V AAA batteries (included).
- Compact size: easy storage and use anywhere.
- Size of the scales: 24x20 cm / Large platform: 22x16 cm / Small platform: 19,5x13,5 cm.



- Báscula digital de alta precisión con bol extraíble de acero inoxidable.
- Diseño elegante y compacto. Capacidad de 1,8 L.
- Pantalla LCD grande y legible con función TARA.
- Indicador de batería baja y sobrecarga.
- Apagado automático, ahorro de energía.
- Unidad de peso: g / lb:oz / water-ml / milk-ml / fl.oz
- Peso máximo: 5kg / División: 1 g
- Fuente de alimentación (incluida): 2 pilas de 1,5 V AAA.
- Su tamaño compacto facilita su almacenamiento.

- Balance numérique de haute précision avec bol extractible en acier inoxydable.
- Design élégant et compact. Capacité de 1,8 L.
- Écran LCD grand et lisible avec fonction TARE.
- Indicateur de batterie faible et de surcharge.
- Arrêt automatique, économies d'énergie.
- Unité de poids : g / lb:oz / water-ml / milk-ml / fl.oz
- Poids maximum : 5 kg / Division : 1 g
- Source d'alimentation (incluse) : 2 piles de 1,5 V AAA.
- Sa taille compacte facilite son rangement.

- High precision digital scales with removable stainless steel bowl.
- Compact, stylish design. Capacity: 1.8 L.
- Large, easily readable LCD screen with TARE function.
- Low power and overload indication.
- Power-saving AUTO-OFF function.
- Weight units: g / lb:oz / water-ml / milk-ml / fl.oz
- Max weight: 5 kg / Division: 1 g.
- Power source: 2 x 1.5 V AAA batteries (included).
- Compact size for easy storage.



INOX

Báscula con bol Just

Balance avec bol · Waage mit Schüssel
Scales with bowl · Balança com taça

| Ref | € | Peso (Kg) | División (g) | L | Unidades | U. Venta |
|-------|-------|-----------|--------------|-----|---------------|----------|
| 61727 | 26,60 | 5 max | 1 | 1,8 | g/lb/ml/fl,oz | 1 |

Báscula de cocina ECO MÁRMOL



- Tecnología sin pilas ni baterías: se carga mediante el giro de la ruleta.
- Sistema EcoMove: convierte la energía cinética (energía en movimiento) en energía eléctrica.
- Fabricada en cristal templado de 4 mm de grosor y acabado con efecto mármol.
- Diseño extraplano.
- Medición de alta precisión. Capacidad máxima de 5 kg con una división de 1 g.
- Pantalla LCD retroiluminada: facilita la lectura de los datos.
- Muestra los resultados en g (gramos), oz (onzas), lb:oz (onzas líquidas), ml-agua (mililitros- agua) y ml-leche (mililitros-leche).
- Apagado y reseteo automático. Función tara.
- Cuatro pies antideslizantes que proporcionan máxima estabilidad y seguridad.

- Technologie sans batteries ni batteries: elle est chargée par la rotation de la roulette.
- Système Ecomove: convertit l'énergie cinétique (énergie en mouvement) en énergie électrique.
- Fabriqué en verre trempé de 4 mm d'épaisseur et fini avec un effet en marbre.
- Conception d'extraplano.
- Mesure de haute précision. Capacité maximale de 5 kg avec une division de 1 g.
- Écran LCD rétroiluminé: facilite la lecture des données.
- Montre les résultats en g (grammes), oz (onces), LB: oz (onces liquides), ml-eau (milliliters-water) et ml-reche (milliliters -leche).
- Réinitialisation automatique et automatique.
- Fonction Tara
- Quatre pieds non glissants qui offrent une stabilité et une sécurité maximales.

- Technology without batteries or batteries: It is loaded by the rotation of the roulette.
- Ecomove system: converts kinetic energy (energy in motion) into electrical energy.
- Made of temperate glass of 4 mm thick and finish with marble effect.
- Extraplane design.
- High precision measurement. Maximum 5 kg capacity with a 1 g division.
- Retroilluminated LCD screen: Facilitates data reading.
- Shows the results in G (grams), Oz (ounces), lb: oz (liquid ounces), ml-water (milliliters-water) and ml-reche (milliliters -leche).
- Out and automatic reset.
- Tare function
- Four non -slip feet that provide maximum stability and safety.



Sistema EcoMove
EcoMove system

Báscula de cocina Eco Mármol

Balance de cuisine · Küchenwaage
Kitchen scale · Balança de cozinha

| Ref | € | cm | División (g) | Peso (Kg) | U. Venta |
|-------|-------|-------------|--------------|-----------|----------|
| 61720 | 35,40 | 19x23,5x3,5 | 1 | 5 | 1 |

Básculas de cocina Mecánicas

INOX
18/10

- Solo uso doméstico, NO comercial.
- Fabricada en acero inoxidable 18/10.
- Permite pesar alimentos de forma cómoda y sencilla.
- No necesita pila.
- Se calibra manualmente.

- Seulement domestique, non commercial.
- Fabriqué en acier inoxydable 18/10.
- Il permet des aliments de manière confortable et simple.
- Il n'a pas besoin d'une bataille.
- Il est calibré manuellement.

- Only domestic, non -commercial.
- Made of stainless steel 18/10.
- It allows foods in a comfortable and simple way.
- It does not need a battle.
- It is manually calibrated.



Báscula de cocina con bol

Balance de cuisine · Küchenwaage
Kitchen scale · Balança de cozinha

| | Ref | € | Peso (Kg) | División (g) | U. Venta |
|---|-------|-------|-----------|--------------|----------|
| A | 61705 | 56,70 | 5 | 20 | 1 |
| | 61710 | 58,40 | 10 | 50 | 1 |
| B | 61715 | 88,10 | 15 | 50 | 1 |

Báscula de cocina

Balance de cuisine · Küchenwaage
Kitchen scale · Balança de cozinha

| | Ref | € | Peso (Kg) | División (g) | U. Venta |
|---|-------|-------|-----------|--------------|----------|
| A | 61702 | 20,60 | 1 | 5 | 1 |
| B | 61714 | 38,20 | 5 | 20 | 1 |

Básculas de precisión



- Ideal para pesar pequeñas cantidades: levadura, especias, suero, aceite, etc.
- Diseñado para recetas de poco gramaje y alta precisión.

- Idéal pour peser de petites quantités: levure, épices, sérum, huile, etc.
- Conçu pour peu de poids et de recettes de haute précision.

- Ideal to weigh small amounts: yeast, spices, serum, oil, etc.
- Designed for little weight and high precision recipes.

Muestra los resultados en gramos (g), onzas (oz), onzas troy (ozt) y quilate (ct)
Shows the results in grams (g), ounces (oz), troy ounces (ozt) and carat (ct).

Muestra los resultados en gramos (g) y onzas (oz)
Shows the results in grams (g) and ounces (oz)



Cuchara medidora digital

Cuillère avec Balance Digital · Digitale Löffelwaage
Digital spoon scale · Colher de pesar Digital

| Ref | € | Peso (g) | División (g) | Largo (cm) | U.Venta |
|-------|-------|----------|--------------|------------|---------|
| 62519 | 40,60 | 300 | 0,10 | 28 | 1 |



INOX ABS
Plastic

Báscula de precisión

Balance de précision · Präzisionswaage
Precision scale · Balança de precisão

| Ref | € | Peso (Kg) | División (g) | cm | U.Venta |
|---------|-------|-----------|--------------|---------------|---------|
| A 61711 | 18,40 | 2,00 | 0,1 | 12,7x10,6x1,7 | 1 |
| B 61709 | 17,60 | 0,65 | 0,1 | 13x8x2 | 1 |

Básculas con gancho

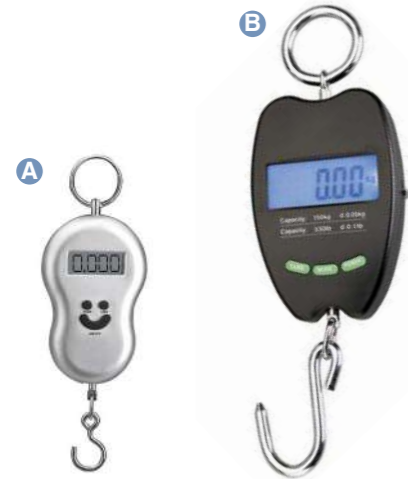

Báscula con gancho

Balance électronique avec crochet · Elektronischeküchenwaage mit Haken
Electronic scale w/hook · Balança de gancho

| Ref | € | Peso (Kg) | División (g) | U.Venta |
|---------|-------|--------------------|--------------|---------|
| A 61721 | 23,30 | 10 | 5 | 1 |
| B 61722 | 74,60 | 0 - 50 50 - 150 | 20 100 | 1 |

Básculas de baño



Báscula de baño

Pèse personne · Personenwaage
Bathroom scale · Escala de banheiro

| Ref | € | cm | Peso (Kg) | División (g) | Unidad | U.Venta |
|-------|-------|---------|-------------|--------------|---------|---------|
| 61740 | 34,00 | 31x31x4 | 180 (397lb) | 100 (0,22lb) | Kg / lb | 1 |



Sistema EcoMove
EcoMove System



Báscula de baño Eco

Pèse personne · Personenwaage
Bathroom scale · Escala de banheiro

| Ref | € | cm | Peso (Kg) | División (g) | U.Venta |
|-------|-------|---------|-----------|--------------|---------|
| 61742 | 39,50 | 31x29x5 | 180 | 100 | 1 |

- Tecnología sin pilas ni baterías: se carga pulsando el botón central.
- Sistema EcoMove: convierte la energía cinética (energía en movimiento) en energía eléctrica.
- Fabricada en cristal templado de 5 mm de grosor y acabado con efecto mármol.
- Diseño extraplano.
- Medición de alta precisión: accionado por 4 sensores de peso de máxima precisión.
- Amplio rango de medición, desde los 8 kg hasta los 180 kg (máx.) con una división de 100 g.
- Pantalla LCD retroiluminada: facilita la lectura de los datos.
- Muestra los resultados en Kg (kilogramos) y lb (libras).
- Apagado y reseteo automático.
- Cuatro pies antideslizantes que proporcionan máxima estabilidad y seguridad.

- Technology without batteries or batteries: It is loaded by pressing the central button.
- Ecomove system: converts kinetic energy (energy in motion) into electrical energy.
- Manufactured in temperate glass of 5 mm thick and finish with marble effect.
- Extraplane design.
- High precision measurement: driven by 4 weight sensors of maximum precision.
- Large measurement range, from 8 kg to 180 kg (max.) With a division of 100 g.
- Retroilluminated LCD screen: Facilitates data reading.
- Shows the results in Kg (kilograms) and LB (pounds).
- Out and automatic reset.
- Four non -slip feet that provide maximum stability and safety.

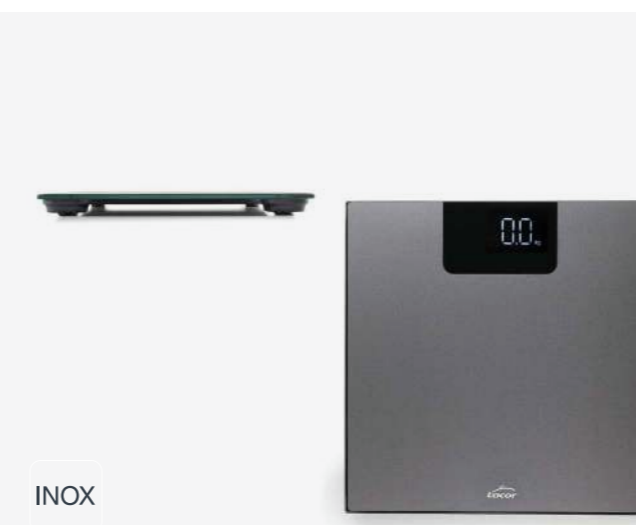

INOX

Báscula de baño Silver

Balance de salle de bain · Badezimmerwaage
Bathroom scales · Balança para quarto de banho

| Ref | € | cm | Peso (Kg) | División (g) | Unidades | U.Venta |
|-------|-------|-----------|-----------|--------------|-------------|---------|
| 61743 | 27,30 | 28,5x28,5 | 180 max | 100 | kg/lb/st:lb | 1 |

- Báscula de baño digital de alta precisión. Soporta un peso máximo hasta 180 kg con una sensibilidad de 100 g de graduación.
- Diseño extraplano.
- Plataforma de pesaje de cristal templado de seguridad con revestimiento mate antideslizante con una capa antihuellas.
- Equipado con un sistema de sensor de galgas extensométricas de alta precisión.
- Pantalla LCD iluminada de gran tamaño, facilita la visibilidad de la medición.
- Función de encendido y apagado automático e indicador de sobrecarga y de batería baja.
- 4 pies antideslizantes con un agarre extra al suelo que proporcionar una gran seguridad durante su uso y evita deslizamientos.
- Batería: 2 pilas de 1,5 V AAA (incluida).

- High precision digital bathroom scale. Holds a maximum weight up to 180 kg with a sensitivity of 100 g graduation.
- Extra flat design.
- Weighing platform made of tempered safety glass with anti-slip matt coating with anti-fingerprint coating.
- Equipped with a high precision strain gauge sensor system.
- Large illuminated LCD display for easy measurement visibility.
- Automatic on/off function and overload and low battery indicator.
- 4 anti-slip feet with extra grip on the floor provide extra safety during use and prevent slipping.
- Battery: 2 x 1.5 V AAA batteries (included).

Termómetros de cocina



Termómetro analógico de Aceite

Thermomètre analogique de huile · Analog Thermometer für Öl
Oil analogic thermometer · Termómetro analógico óleo

| Ref | € | cm | Rango temperatura | U.Venta |
|-------|-------|--------|----------------------------|---------|
| 62495 | 12,70 | 5x30,5 | 40°C (104°F)-200°C (392°F) | 1 |

Termómetro Dual

Thermomètre · Thermometer
Thermometer · Termómetro



| Ref | € | Rango temperatura | Sonda | U.Venta |
|-------|--------|-----------------------------|-----------------------------|---------|
| 62458 | 106,50 | -40°C (-40°F)/230°C (302°F) | -33°C (-27°F)/220°C (428°F) | 1 |

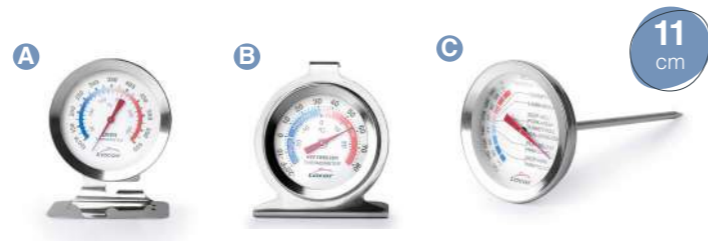

Termómetro

Thermomètre · Thermometer
Thermometer · Termómetro

| Ref | € | Temperatura | U.Venta |
|---------|-------|----------------------------|---------|
| A 62454 | 10,00 | -30°C (-22°F)/30°C (86°F) | 1 |
| B 62450 | 7,80 | -54°C (129°F)/88°C (190°F) | 1 |
| C 62452 | 8,40 | 50°C (122°F)/300°C (572°F) | 1 |

Termómetro digital Carne

Thermomètre Electronique · Electric Thermometer
Thermometer, Elektronisch · Termómetro Electrónico

| Ref | € | Rango temperatura | U.Venta |
|-------|-------|-----------------------------|---------|
| 62459 | 21,30 | -40°C (-40°F)/150°C (302°F) | 1 |



Termómetro Digital

Thermomètre numérique · Digital Thermometer
Digital thermometer · Termómetro Digita

| Ref | € | Largo (cm) | Temperatura | U.Venta |
|---------|-------|------------|-----------------------------|---------|
| A 62487 | 30,60 | 23 | 0°C (-32°F)/300°C (572°F) | 1 |
| B 62453 | 21,20 | 15 | -40°C (-40°F)/150°C (302°F) | 1 |

Termómetro Sonda

Thermomètre sonde · Thermometer/Sonde
Thermometer probe · Termómetro sonda

| Ref | € | Temperatura | Largo (cm) | U.Venta |
|---------|-------|-----------------------------|------------|---------|
| A 62500 | 16,40 | -50°C (-64°F)/300°C (572°F) | 25 | 1 |
| B 62528 | 17,70 | -50°C (-64°F)/300°C (572°F) | 25 | 1 |

Termómetro digital horno

Thermomètre numérique pour le four · Digitaler Ofen-Thermometer
Oven digital thermometer · Termómetro digital forno

| Ref | € | cm | Rango temperatura | U.Venta |
|-------|-------|--------|-----------------------------|---------|
| 62498 | 50,80 | 12x7,5 | 0°C (-32°F) / 300°C (572°F) | 1 |

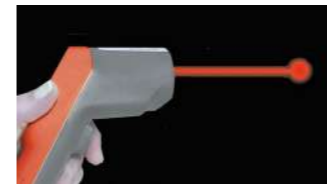

NUNCA APUNTE CON EL DISPOSITIVO LOS OJOS DE ALGUIEN
He jamais pointer l'instrument vers les yeux de quelqu'un
Never point the device towards anyone's eyes

Termómetro infrarrojos Laser

Therm. mesure de surface par infra rouge · Infrarot Thermometer
Infrared thermometer · Termómetro infravermelhos

| Ref | € | Rango temperatura | U.Venta |
|-------|--------|-------------------------------|---------|
| 62457 | 126,10 | -50°C (-58°F) / 400°C (752°F) | 1 |

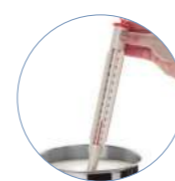

PP

Polypropylene

Termómetro leche

Thermomètre à lait · Milch Thermometer
Milk thermometer · Termómetro de leite

| Ref | € | Largo (cm) | Rango temperatura | U.Venta |
|-------|-------|------------|-------------------|---------|
| 62532 | 12,10 | 26,5 | -10°C / +110°C | 1 |

Relojes de cocina



Reloj cocina con alarma

Minuteur de Cuisine avec Alarme · Küchen-Zeitschaltuhr mit Alarm
Kitchen Timer Alarm · Relógio de cozinha com alarme

| Ref | € | cm | U.Venta |
|-------|-------|-------------|---------|
| 60804 | 40,00 | 13x24,5x2,5 | 1 |



Reloj digital

Miniuter Électronique · Digitale Küchen-Zeitschaltuhr mit Alarm
Digital kitchen timer w/alarm · Relógio digital de cozinha com alarme acústico

| Ref | € | cm | Programas | U.Venta |
|-------|------|--------|-----------|---------|
| 60805 | 9,20 | 10,5x7 | 10 | 1 |



Reloj de cocina magnético

Minuteur de cuisine magnetique · Magnetküchentimer
Magnetic kitchen timer · Relógio de cozinha magnetico

| Ref | € | cm | Tiempo | U.Venta |
|-------|-------|---------|--------|---------|
| 60803 | 11,10 | 9,2x3,5 | 60 min | 1 |



Soporte plegable.
Potente imán.
Folding stand.
Powerful magnet

Reloj cocina White

Minuteur de Cuisine avec Alarme · Küchen-Zeitschaltuhr mit Alarm
Kitchen Timer Alarm · Relógio de cozinha com alarme

| Ref | € | cm | U.Venta |
|-------|-------|-----------|---------|
| 60802 | 20,10 | 7x1,4x5,1 | 1 |

Profesional Collection

INOX 
Dishwasher

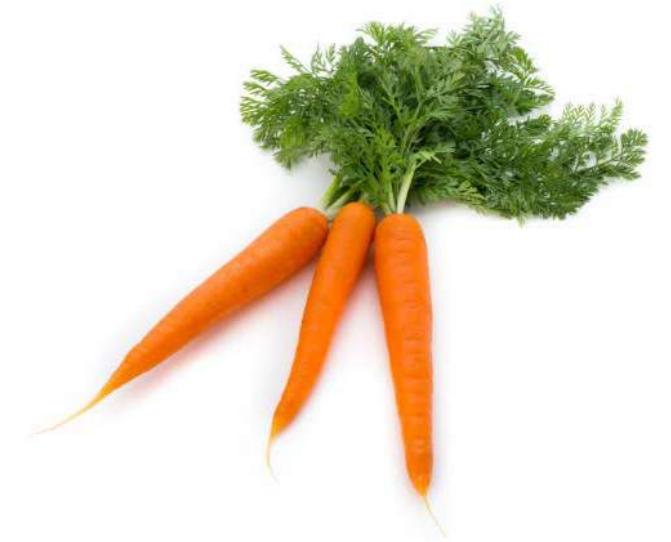

Utensilios de corte Cutting utensils



Cortador de bolas
Cuillere à pommes · Kugelausstecher
Fruit baller · Cortador bolas

| Ref | € | Ø (mm) | U.Venta |
|-------|------|--------|---------|
| 60366 | 7,80 | 15 | 1 |
| 60367 | 7,90 | 20 | 1 |
| 60368 | 7,90 | 25 | 1 |
| 60369 | 8,00 | 30 | 1 |



Cortador de bolas rizado
Cuillere à pommes forme oval canelée ·
Kugelausstecher oval, gerippt
Fruit baller oval fluted · Cortador bolas oval frizado

| Ref | € | mm | U.Venta |
|-------|------|---------|---------|
| 60372 | 8,70 | 20x32,5 | 1 |



Cuchillo vaciador
Couteau pour fruits · Frucht messer
Fruit knife · Faca para fruta

| Ref | € | mm | U.Venta |
|-------|------|--------|---------|
| 60399 | 6,20 | 20x105 | 1 |



Pelapatatas Y
Éplucheur "Y" · "Y" Schäler
"Y" Peeler · Pela-batatas "Y"

| Ref | € | mm | U.Venta |
|-------|-------|-------|---------|
| 60377 | 9,80 | 55x55 | 1 |
| 60378 | 10,40 | 55x55 | 1 |

Liso
Plane
Dentado
Serrated



Pelapatatas P
Éplucheur "P" · "P" Schäler
"P" Peeler · Pela-batatas "P"

| Ref | € | mm | U.Venta |
|-------|------|-------|---------|
| 60380 | 6,80 | 16x55 | 1 |



Pelador cuchillas fija
Éplucheur lame fixe · Schäler Messerfix
Fix blade peeler · Pela-batatas lâmina fixa

| Ref | € | mm | U.Venta |
|-------|------|-------|---------|
| 60398 | 5,30 | 15x75 | 1 |



Luxe Collection

INOX  Dishwasher



Cuchillo para queso
Couteaux à fromage · Käsemesser
Cheese knife kitchen tool · Faca para queijo

| Ref | € | cm | Largo (cm) | U.Venta |
|-------|-------|----|------------|---------|
| 62675 | 11,70 | 14 | 28 | 6 |



Espátula lisa
Spatule lisse · Backschaufel
Spatula · Espátula

| Ref | € | cm | Largo (cm) | U.Venta |
|-------|-------|--------|------------|---------|
| 62676 | 10,00 | 4,3x11 | 25 | 6 |



Descorazonador
Vide-pommes · Apfelenkerner
Aple corer · Descaroçador

| Ref | € | cm | Largo (cm) | U.Venta |
|-------|-------|-----|------------|---------|
| 62686 | 10,20 | 2x2 | 20 | 6 |



Cortador de bolas
Cuillère à pommes · Kugelausstecher
Fruit baller · Cortador de bolas

| Ref | € | cm | Largo (cm) | U.Venta |
|-------|------|-----|------------|---------|
| 62683 | 9,10 | 3x1 | 19 | 6 |



Pelapatatas "Y"
Éplucheur "Y" · "Y" Schäler
"Y" Peeler · Descascador de batatas "Y"

| Ref | € | cm | Largo (cm) | U.Venta |
|-------|-------|-----|------------|---------|
| 62687 | 11,90 | 5x2 | 18 | 6 |



Pelapatatas "P"
Éplucheur "P" · "P" Schäler
"P" Peeler · Descascador de batatas "P"

| Ref | € | cm | Largo (cm) | U.Venta |
|-------|-------|-----|------------|---------|
| 62688 | 10,90 | 2x1 | 20 | 6 |



Pala pastel serrada
Palette à gâteau dentellé · Kuchenschaufel
Serrated cake shovel · Espátula de bolos c/serrilha

| Ref | € | cm | Largo (cm) | U.Venta |
|-------|-------|--------|------------|---------|
| 62673 | 12,90 | 5,5x13 | 26 | 6 |



Abre ostras
Couteau à huîtres · Austermesser
Oyster opener · Aberto-ostras

| Ref | € | Largo (cm) | U.Venta |
|-------|-------|------------|---------|
| 62684 | 12,90 | 20 | 1 |



Prensa ajos
Presse-pail · Knoblauchpresse
Garlic press · Esmaga-alhos

| Ref | € | cm | Largo (cm) | U.Venta |
|-------|-------|-----|------------|---------|
| 62685 | 24,70 | 3x5 | 18 | 6 |

Abrelatas
Ouvre-boîte · Dosenöffner
Can opener · Abre-latas



| Ref | € | cm | Largo (cm) | U.Venta |
|-------|-------|-----|------------|---------|
| 62689 | 27,20 | 5x4 | 20 | 6 |

Peladores

INOX  Dishwasher



Pelador tomate dentado P Red
Épluche tomates à dents P · Tomatenschäler, gezackt, P
P Serrated tomato peeler · Pelador tomate dentado P

| Ref | € | Largo (cm) | U.Venta |
|-------|-------|------------|---------|
| 60351 | 14,70 | 19,5 | 1 |



Pelador tomate dentado Y Red
Épluche tomates à dents Y · Tomatenschäler, gezackt, Y
Y Serrated tomato peeler · Pelador tomate dentado Y

| Ref | € | Largo (cm) | U.Venta |
|-------|-------|------------|---------|
| 60352 | 14,40 | 17,5 | 1 |



Descorazonador Red
Vide tomates · Tomatenentkerner
Tomato core remover · Descaraçador

| Ref | € | Largo (cm) | U.Venta |
|-------|-------|------------|---------|
| 60353 | 11,00 | 16,5 | 1 |



Cuchillo dentado Red
Couteau à dents à tomates · Tomatenmesser, gezahnt
Serrated tomato knife · Faca dentada

| Ref | € | Largo (cm) | U.Venta |
|-------|-------|------------|---------|
| 60354 | 10,90 | 22 | 1 |



Pelador liso Red
Éplucheuse plate · Normalen Schäler
Peeler plain blade · Descascador liso

| Ref | € | Largo (cm) | U.Venta |
|-------|-------|------------|---------|
| 60547 | 11,20 | 12,5 | 1 |



Pelador Inox
Éplucheuse · Schäler
Peeler · Descascador

| Ref | € | cm | U.Venta | |
|-------|-------|--------|---------|------------------|
| 60346 | 12,20 | 5,5x12 | 1 | Liso · Line |
| 60347 | 12,20 | 5,5x12 | 1 | Dentado Serrated |



Pelador Unite
Éplucheuse · Schäler
Peeler · Descascador

| Ref | € | Largo (cm) | U.Venta | |
|-------|------|------------|---------|------------------|
| 68197 | 4,30 | 14,5 | 1 | Liso Plane |
| 68198 | 4,30 | 14,5 | 1 | Dentado Serrated |



Pelador ceramico Y
Éplucheuse en céramique Y · Y Schäler, Keramik
Y ceramic peeler · Descascador cerâmico Y

| Ref | € | cm | U.Venta |
|-------|------|----------|---------|
| 60444 | 4,10 | 8,5x16,5 | 6 |



Pelador Y cuchillas giratorias
Éplucheuse "Y" lames tournantes · "Y" Schäler, rotierende Messer
"Y" type peeler rotating blades · Descascador "Y" lâminas giratórias

| Ref | € | Largo (cm) | U.Venta |
|-------|-------|------------|---------|
| 60389 | 24,10 | 20 | 1 |



ABS Plastic INOX BPA free

INOX TPE Plastic BPA free

Pelador de aguacate

Coupe avocat · Schäler avocado
Avocado peeler · Descascador abacate

| Ref | € | cm | U.Venta |
|-------|------|------|---------|
| 61355 | 8,80 | 28x4 | 1 |

Laminador de aguacate

Éplucheuse avocats · Schäler avocados
Avocado slicer · Descascador abacater

| Ref | € | cm | Largo (cm) | U.Venta |
|-------|-------|-----|------------|---------|
| 61353 | 12,10 | 6,2 | 24 | 1 |



INOX ABS Plastic BPA free

Pelador de piña

Set coupe ananas · Ananas-Schäler
Pineapple peeler · Pelador de ananas

| Ref | € | Ø (cm) | h(cm) | U.Venta |
|-------|-------|--------|-------|---------|
| 60392 | 11,60 | 10 | 23 | 4 |

Pelador de piña Slize

Set coupe ananas · Ananas-Schäler
Pineapple peeler · Pelador de ananas

| Ref | € | Ø (cm) | h(cm) | U.Venta |
|-------|------|--------|-------|---------|
| 68806 | 3,90 | 9 | 24 | 1 |



INOX ABS Plastic

Juego cortador-pelador piña

Jeu couteau et éplucheur ananas · Messer und Schäler set für ananas
Set pineapple cutter-peeler with canister · Jogo cortador e descascador de ananas

| Ref | € | Ø (cm) | U.Venta |
|-------|-------|--------|---------|
| 60393 | 25,30 | 9 | 1 |



Picadoras

INOX 18/10



- Picadora de mecanismo manual que pica todo tipo de alimentos, como verduras, frutas, jengibre, ajo, cebolla, frutos secos y hierbas.
- Cuchilla de acero inoxidable de máxima calidad.
- Recipiente transparente para visualizar el proceso. Libre de BPA.
- Muy fácil y cómodo de usar gracias a su sistema manual PressTurn.
- Tapa de polietileno antideslizante para facilitar la tarea y evitar desplazamientos.
- Fácil de desmontar y limpiar.

- Choppeur de mécanisme manuel qui démange tous les types de nourriture, comme les légumes, les fruits, le gingembre, l'ail, l'oignon, les noix et les herbes.
- Lame en acier inoxydable de qualité maximale.
- Conteneur transparent pour visualiser le processus. Sans BPA.
- Très facile et confortable à utiliser grâce à son système manuel PressTurn.
- Couverture en polyéthylène non glissé pour faciliter la tâche et éviter les déplacements.
- Facile à démonter et à nettoyer.

- Manual mechanism chopper that itch all types of food, such as vegetables, fruits, ginger, garlic, onion, nuts and herbs.
- Maximum quality stainless steel blade.
- Transparent container to visualize the process. BPA free.
- Very easy and comfortable to use thanks to its pressturn manual system.
- Non-slip polyethylene lid to facilitate task and avoid displacements.
- Easy to disassemble and clean.



Picadora manual Inox

Hachoir manuel · Handschneider
Manual food chopper · Picador manual

| Ref | € | Ø (cm) | h(cm) | U.Venta |
|-------|-------|--------|-------|---------|
| 62980 | 32,80 | 9,5 | 22 | 6 |



Picaperejil

Hachoir à manivelle pour fines herbes · Kräutermühle, fein
St.steel fine herbs mincer · Pica-salsa

| Ref | € | cm | U.Venta |
|-------|-------|-------------|---------|
| 60334 | 22,90 | 13,5x20x7,5 | 1 |

Multifuncional: pica, bate y centrifuga

Mecanismo de manivela que requiere muy poca fuerza
Multifunctional: chop, beat and spin
Crank mechanism requiring very little force

Sistema TurnCut

Accionamiento manual de la manivela 100% estable. Sujeción mediante ventosa
TurnCut System
Manual crank operation
100% stable. Suction cup fastening



INOX

Picadora de carne manual

Hachoir avec manivelle · Fleischwolf mit handkurbe
Meat mincer · Picadora de carne manual

| Ref | € | cm | U.Venta |
|-------|--------|----------|---------|
| 60329 | 127,20 | 17x12x19 | 1 |



Mini picadora-batidora manual

Mini hachoir-fouet manuel · Minizerhacker-Schneebesen
Manual mini chooper-whisk · Mini picadora-batedeia manual

| Ref | € | Ø (cm) | L | U.Venta |
|-------|-------|--------|------|---------|
| 60361 | 18,60 | Ø17x18 | 1,00 | 1 |



INOX 18/10 ABS Plastic Dishwasher BPA free

Picadora White

Hachoir avec manivelle · Fleischwolf mit handkurbe
Meat mincer · Picadora de carne manual

| Ref | € | cm | U.Venta |
|-------|-------|-------|---------|
| 60340 | 35,60 | 18x22 | 1 |

Garras de oso

INOX BAQUELITA Dishwasher
Bakelite



Manipula carnes. Desmenuza carnes
Manipulate meat. Crumble meats

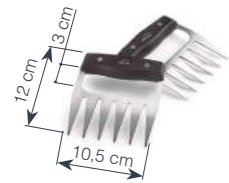

Garras de oso
Griffes à viande · Fleisch Bärenkrallen
Bear claws for meat · Garras de urso para carne

| Ref | € | cm | U.Venta |
|-------|-------|---------|---------|
| 38015 | 13,00 | 10,5x12 | 1 |

- Fabricadas en acero inoxidable de máxima calidad.
- Diseñadas para desmenuzar y manipular carnes hechas al horno o barbacoa, como pollo, carne de vacuno, pavo, aves, jamón, etc.
- Puntas afiladas para manipular la carne sin esfuerzo. Forma curvada para un mejor agarre y mayor comodidad.
- Mangos ergonómicos de baquelita resistentes al calor, 100% seguros.
- Multifuncional: desmenuza y traslada la carne, facilita la sujeción para cortes con cuchillo, remueve las ensaladas o pastas, etc.
- Fácil de limpiar. Aptas para el lavavajillas.

- Fabriqué en acier inoxydable de qualité maximale.
- Conçu pour s'effondrer et manipuler la viande de viande, comme le poulet, le bœuf, la dinde, les oiseaux, le jambon, etc.
- Des conseils pointus pour gérer la viande sans effort. Forme incurvée pour une meilleure adhérence et un plus grand confort.
- Mangues de baquelite ergonomiques résistantes à la chaleur, 100% d'assurance.
- Multifonctionnel: s'effondre et déplace la viande, facilite la fixation des coupures de couteau, retirer les salades ou les pâtes, etc.
- Facile à nettoyer. Convient au lave-vaisselle.

- Manufactured in maximum quality stainless steel.
- Designed to crumble and handle meat-made meats, such as chicken, beef, turkey, birds, ham, etc.
- Sharp tips to handle meat effortlessly. Curved form for a better grip and greater comfort.
- Ergonomic baquelite mangoes resistant to heat, 100% insurance.
- Multifunctional: crumbles and moves the meat, facilitates the fastening for knife cuts, remove salads or pasta, etc.
- Easy to clean. Suitable for dishwasher.



Cortadores

INOX Dishwasher BPA free



Cortador manual Affilato
Coupe manuel · Manuelle Schneider
Manual chopper · Cortador manual

| Ref | € | Ø (cm) | h(cm) | L | U.Venta |
|-------|-------|--------|-------|-----|---------|
| 60599 | 25,60 | 13 | 14 | 1,2 | 1 |



Velocidad I · Speed I
Corta y pica más grueso
Cut and chopp more coarsely



Velocidad II · Speed II
Corta y pica más fino
Cut and chopp more finely



Corta alimentos duros
It cuts thicker foods



Corta alimentos blandos
It cuts softer foods



Cuchillas ultrarresistentes
Ultra-strongs blades



Cortador manual Sharp
Coupe manuel · Manueller Schneider
Manual cutter · Cortador manual

| Ref | € | Ø (cm) | Cuchillas | h(cm) | L | U.Venta |
|-------|-------|--------|-----------|-------|-----|---------|
| 60299 | 21,70 | 12 | 3 | 11 | 0,5 | 1 |
| 60499 | 23,00 | 13 | 5 | 14 | 1,0 | 1 |

Pica y corta alimentos en segundos
It chops and slices foods in seconds



3 cuchillas (6 - 9 - Rodajas 6 mm)
2 empujadores
Peines de limpieza
3 blades (6 - 9 - Slice 6 mm)
2 pushers
Cleaning combs



Corte en rodajas y juliana
Sliced and julienne cut



Cortador de verduras y chips
Coupe de légumes · Gemüseschneidmaschine
Chips and vegetable cutter · Cortador de verdura e chips

| Ref | € | cm | h(cm) | Cuchillas | U.Venta |
|-------|-------|-----------|-------|-----------|---------|
| 60344 | 46,50 | 11,5x21,5 | 11 | 3 | 1 |



INOX 18/10 PP Polypropylene BPA free

Cortador de patatas Hasselback

Coupe-pommes de terre Hasselback · Hasselback-Kartoffelschneider
Hasselback potato slicer · Cortador de batatas Hasselback

| Ref | € | cm | h(cm) | U.Venta |
|-------|------|-------|-------|---------|
| 68180 | 9,90 | 18x10 | 2,1 | 1 |



Cortador de patatas ondulado

Coupe-frites ondulé · Kartoffel-Wellenschneider
Crinkle cut potato slicer · Cortador de batatas ondulado

| Ref | € | cm | h(cm) | U.Venta |
|-------|------|--------|-------|---------|
| 62895 | 3,00 | 14x9,5 | 2 | 1 |

ZAMAK Zinc Alloy



Cortahuevos

Coupe-oeuf · Eirschneider
Egg cutter · Corta-ovos

| Ref | € | Ø (cm) | U.Venta |
|---------|-------|-----------|---------|
| A 68305 | 20,50 | 7 | 1 |
| B 68306 | 18,50 | 10 | 12 |
| C 68307 | 36,50 | 15x10x3,7 | 1 |



Cortador en espiral espagueti

Coupe en spirale · Spiralschneider
Spiral cutter · Cortador em espiral

| Ref | € | Diámetro interior (cm) | Cuchilla (cm) | U.Venta |
|-------|------|------------------------|---------------|---------|
| 60529 | 4,10 | 8 | 5,5 | 6 |



ABS Plastic

Deshojador de hierbas aromáticas

Effeulleuse à herbes aromatiques · Entblätterer für gewürzkräuter
Aromatic herb stripper · Desfolhador de ervas aromáticas

| Ref | € | cm | U.Venta |
|-------|------|------------|---------|
| 61359 | 6,70 | 16,5x7,5x2 | 1 |



Cortador de verduras Double

Hachoir de légumes double manuel · Doppelschneidiges Hand Wiegemesser
Vegetables manual double blade chopper · Corta verduras manual duplo lâmina

| Ref | € | cm | U.Venta |
|-------|-------|------|---------|
| 60365 | 17,00 | 17x2 | 10 |



Cortador en espiral manual

Coupe en spirale manuelle · Manueller Spiralschneider
Manual spiral cutter · Cortador em espiral manual

| Ref | € | Ø (cm) | h(cm) | L | U.Venta |
|-------|-------|--------|-------|------|---------|
| 60524 | 19,10 | 9 | 22 | 0,40 | 1 |



INOX BPA free

Descorazonador manual

Vide-pommes manuel · Apfelenkerner
Manual apple corer · Descorçador manual

| Ref | € | U.Venta |
|-------|------|---------|
| 60350 | 7,90 | 1 |

INOX PP Polypropylene BPA free

Corta melones-sandías

Trancheur à melons · Wassermelonen-Schneider
Melon cutter-watermelon · Corte os melões-melancia

| Ref | € | Ø (cm) | U.Venta |
|-------|-------|--------|---------|
| 60397 | 20,60 | 25,8 | 1 |

Guían el cuchillo para un corte perfecto y uniforme
Guide the knife for perfect and even slicing



Peine cortacarne

Peigne pour coupe viande · Fleischzange
Meat tong · Pinça/pente corta-carne

| Ref | € | cm | h (cm) | U.Venta |
|-------|-------|-------|--------|---------|
| 60336 | 20,20 | 11x30 | 6,5 | 6 |



INOX 18/10

Cortabacalao

Couper la morue · Kabeljau-Schneider
Cut cod · Corta-bacalhau

| Ref | € | cm | U.Venta |
|-------|--------|-----------|---------|
| 60000 | 248,30 | 11x58,5x8 | 1 |



INOX 18/10

Cortaquesos cuchilla

Coupe-fromage avec lame · Käsemesser, mit Klinge
Cheese cutter with blade · Corta-queijos lâmina

| Ref | € | cm | h(cm) | U.Venta |
|-------|-------|---------|-------|---------|
| 60005 | 29,60 | 27,5x21 | 3 | 1 |

Cuchilla de 6 cm de largo
6 cm long blade



INOX 18/10

Laminador de trufa

Coupe-Truffles · Truffelschneider
Truffle-slicer · Laminador trufa

| Ref | € | Largo (cm) | U.Venta |
|-------|-------|------------|---------|
| 61351 | 14,80 | 18 | 1 |

Regular de grosor
Regular thickness



Cortador de queso fresco

Fromage coupe fil · Draht-Käseschneider
Cheese wire cutter · Corta-queijos

| Ref | € | cm | U.Venta |
|-------|------|----|---------|
| 60004 | 4,90 | 17 | 12 |
| 60009 | 5,40 | 21 | 12 |

Triturador tomate

INOX ABS Plastic SAN Plastic LDPE Polyethylene BPA free



Salida para desechos
Outlet for waste

Triturador de tomate

Trancheur à melons · Wassermelonen-Schneider
Melon cutter-watermelon · Corte os melões-melancia

| Ref | € | U.Venta |
|-------|-------|---------|
| 60394 | 48,50 | 1 |



Ralladores

INOX
Dishwasher



ABS Plastic PS Plastic BPA free

Rallador 4 caras KEEP

Râpe 4 faces avec récipient · 4-seitige Reibe
4-sided grater with container · Ralador 4 lados c/recipiente

| Ref | € | cm | h(cm) | U.Venta |
|-------|------|---------|-------|---------|
| 61363 | 6,30 | 8,9X6,5 | 20,5 | 6 |

HAYA Wood



Rallador 4 caras Wood

Râpe 4 faces · 4-seitige Reibe
4-sided grater · Ralador 4 lados

| Ref | € | cm | h(cm) | U.Venta |
|---------|-------|--------|-------|---------|
| A 61364 | 11,30 | 11x8,5 | 24,8 | 1 |
| B 61365 | 9,30 | 9x6,5 | 22,0 | 1 |

INOX 18/10



Rallador Multi

Râpe · Reibe
Grater · Ralador

| Ref | € | h (cm) | U.Venta |
|---------|-------|--------|---------|
| A 60307 | 16,50 | 23 | 6 |
| B 60305 | 7,20 | 24 | 6 |



Rallador Luxe

Râpe · Reibe
Grater · Ralador

| Ref | € | h(cm) | U.Venta |
|-------|-------|-------|---------|
| 61354 | 28,60 | 23,5 | 1 |



Rallador con manivela Inox

Hachoir en inox · Käsereiber, Rostfrei
St.steel cheese grater · Ralador inox com manivela

| Ref | € | cm | U.Venta |
|-------|-------|------------|---------|
| 60335 | 35,30 | 13,5x20x10 | 1 |



Rallador de limón

Râpe muscade · Zitronenreibe
Grater semi-circular · Ralador de limão

| Ref | € | cm | U.Venta |
|-------|------|------|---------|
| 67008 | 6,20 | 23x6 | 12 |



Rallador plano 3 usos

Râpe plat · Reibe 3 Nützlichkeit
Grater 3 uses · Ralador plano 3 usos

| Ref | € | cm | U.Venta |
|-------|------|---------|---------|
| 60301 | 7,80 | 25,5x11 | 12 |



Rallador plano paso grueso

Râpe plat · Reibe, grob
Grater big hole · Ralador plano passo grosso

| Ref | € | cm | U.Venta |
|-------|------|---------|---------|
| 60302 | 7,80 | 25,5x11 | 12 |



Rallador plano paso fino

Râpe plat · Reibe, fein
Grater small hole · Ralador plano passo fino

| Ref | € | cm | U.Venta |
|-------|------|---------|---------|
| 60303 | 7,80 | 25,5x11 | 12 |



Rallador especias mini

Râpe à épices mini · Mini-Reibe Gewürze
Mini spices grater · Ralador especiarias mini

| Ref | € | cm | U.Venta |
|-------|------|------|---------|
| 67032 | 3,70 | 11x7 | 6 |



Rallador nuez moscada

Râpe à muscade · Musket Reibe
Nutmeg grater · Ralador noz-moscada

| Ref | € | cm | U.Venta |
|-------|-------|-------|---------|
| 67031 | 10,60 | 4,5x3 | 12 |



Rallador nuez moscada mini

Râpe à noix de muscade mini · Mini-Musket Reibe
Mini nutmeg grater · Ralador noz-moscada mini

| Ref | € | U.Venta |
|-------|------|---------|
| 67009 | 2,20 | 12 |



Rallador Dual

Râpe · Reibe
Grater · Ralador

| Ref | € | Largo (cm) | U.Venta |
|-------|-------|------------|---------|
| 61360 | 10,40 | 31,0 | 6 |



Rallador inox black

Râpe · Reibe
Grater · Ralador

| Ref | € | U.Venta |
|---------|-------|---------|
| A 61341 | 16,00 | 1 |
| B 61342 | 16,00 | 1 |
| C 61343 | 16,00 | 1 |
| D 61344 | 16,00 | 1 |

Extra fino · Extra thin
Fino · Thin
Grueso · Thick
Juliana · Julienne



Rallador inox black Largo

Râpe longue · Reibe, lang
Lengthways grater · Ralador comprimo

| Ref | € | U.Venta |
|---------|-------|---------|
| A 61346 | 16,00 | 1 |
| B 61347 | 16,00 | 1 |
| C 61348 | 16,00 | 1 |
| D 61349 | 16,00 | 1 |

Fino · Thin
Medio · Medium
Grueso · Thick
Fino+Medio · Thin+Medium

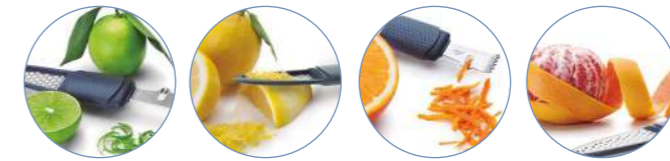

Rallador decorador multusos

Râpe pour décoration multi-usages
Mehrzweckreibe zum Verzieren
Multipurpose zester · Ralador decorador multusos

| Ref | € | Largo (cm) | U.Venta |
|-------|-------|------------|---------|
| 63911 | 11,60 | 18,0 | 1 |



4 in 1



INOX HAYA Wood



Rallador Cónico

Râpe ronde · Reibe, Konisch
Conical grater · Ralador cónico

| Ref | € | Ø (cm) | h (cm) | U.Venta |
|-------|------|--------|--------|---------|
| 61366 | 5,60 | 12 | 27 | 1 |

Mandolinas



Plegable
Bloqueo de seguridad
Fold up
Safety lock position



Mandolina vertical

Mandoline verticale · Mandoline, Vertikale
Vertical mandoline · Mandolina vertical

| Ref | € | Rodaja (mm) | Juliana (mm) | Cubos (mm) | U.Venta |
|-------|-------|-------------|--------------|-------------|---------|
| 60460 | 41,30 | 0,5 - 8 | 4 - 8 | 8x8 / 0,5x4 | 1 |

- Ahorra tiempo gracias a su corte fácil, rápido y seguro.
- Su cuchilla extremadamente afilada proporciona un corte homogéneo y preciso.
- Tipo de corte:
 - Corte liso/rodajas regulable de 0,5 - 8 mm
 - Corte en juliana 8 mm
 - Corte en juliana 4 mm
 - Corte en cubos (excepto ref.: 60560).
- Corte por accionamiento vertical con una palanca de retroceso automático.
- Amplia capacidad del depósito de alimentación posibilidad de meter alimentos grandes o más de uno.
- Protector contra cortes, no hay contacto directo con las manos durante su uso.
- Dispone de un contenedor que recoge los alimentos cortados.
- Ocupa poco espacio, se pliegan el pie y se recoge el mango.
- Palanca con posición de bloqueo de seguridad, muy seguro para su transporte y almacenaje.

- Gagnez du temps grâce à son système de coupe facile, rapide et sûr
- Sa lame extrêmement affilée confère une coupe homogène et précise
- Types de coupe :
 - Coupe lisse/rondelles à épaisseur variable de 0,5 à 8 mm.
 - Coupe en julienne 4 mm.
 - Coupe en julienne 8 mm
 - Découpage en cubes (sauf réf. : 60560).

- Coupe par actionnement vertical avec un levier à retour automatique
- Grande capacité de la trémie d'alimentation : possibilité de mettre de gros aliments ou plus d'un aliment.
- Protection anti-coupures. Pas de contact direct avec les mains pendant l'utilisation
- Dispose d'un conteneur qui recueille les aliments coupés
- Prend peu de place. Pied pliable et manche rabattable
- Levier avec position de blocage de sécurité, très sûr pour le transport et le rangement

- Saves time thanks to its easy, fast and safe cutting
- It's extremely sharp blade enables even and precise cutting
- Type of cut:
 - Smooth cut/adjustable slices from 0.5 - 8 mm
 - Julienne cut 4 mm
 - Julienne cut 8 mm
 - Cutting into cubes (except ref.: 60560).
- Vertically operated cutting with an automatic recoil lever
- Large capacity of the feed hopper (9x10 cm) possibility to put large feed or more than one feed.
- Anti-cut protector; no direct contact with hands during use
- Includes a container that collects the chopped food
- Takes up little space as the legs fold up and the handle pushes in
- Lever with safety lock position; very safe for transport and storage

3 tipos de corte · 3 types of cut

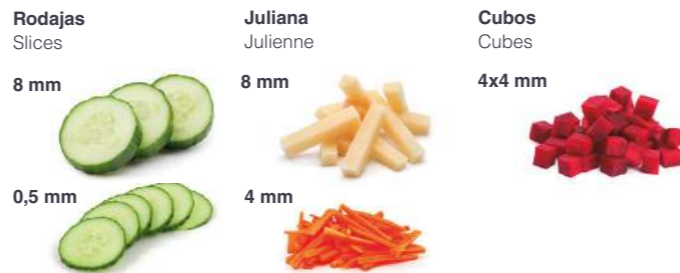

garinox®



Mandolina vertical Precis

Mandoline verticale · Mandoline, Vertikale
Vertical mandoline · Mandolina vertical

| Ref | € | Rodaja (mm) | Juliana (mm) | U.Venta |
|-------|-------|-------------|--------------|---------|
| 60560 | 21,20 | 2 - 4 | 4 - 8 | 1 |



8 Funciones
Functions

5 Cuchillas
Blades

Mandolina Multi

Mandoline · Mandoline
Mandoline · Mandolina

| Ref | € | cm | Cuchillas | U.Venta |
|-------|-------|-----------|-----------|---------|
| 60331 | 31,70 | 14,5x34,5 | 5 | 1 |

5 Cuchillas
Blades



Mandolina Luxe

Mandoline · Mandoline
Mandoline · Mandolina

| Ref | € | cm | Cuchillas | U.Venta |
|-------|--------|-------|-----------|---------|
| 60332 | 120,30 | 14x42 | 5 | 1 |



8 Funciones
Functions

5 Cuchillas
Blades

Mandolina V

Mandoline · Mandoline
Mandoline · Mandolina

| Ref | € | cm | Cuchillas | U.Venta |
|-------|-------|---------|-----------|---------|
| 60356 | 39,00 | 13x33,5 | 5 | 1 |



Cuchillas giratorias
Rotating blades



Mandolina Safe

Mandoline · Mandoline
Mandoline · Mandolina

| Ref | € | cm | Cuchillas | U.Venta |
|-------|--------|---------|-----------|---------|
| 60357 | 130,30 | 12,5x50 | 4 | 1 |



Mandolina bidireccional Lisa Fast

Mandoline double coupè · Mandoline double schneider
Dual slice mandoline · Mandolina duplo corte

| Ref | € | cm | U.Venta |
|-------|-------|-------|---------|
| 60275 | 14,30 | 14x42 | 1 |



Mandolina bidireccional juliana Fast

Mandoline double coupè · Mandoline double schneider
Dual slice mandoline · Mandolina duplo corte

| Ref | € | cm | U.Venta |
|-------|-------|-------|---------|
| 60276 | 15,40 | 14x42 | 1 |

- Mandolina bidireccional con cuchilla de acero inoxidable y cuerpo fabricado en materiales de máxima calidad, libres de BPA.
- Cuchillas extremadamente afiladas que proporcionan un corte homogéneo y preciso.
- Dos tipos de corte: fino de 1 mm y grueso de 3 mm (Ref.: 60275). Corte en Juliana de 3x3 mm de sección (Ref.: 60276).
- Diseño práctico y compacto.
- Corte seguro: base antideslizante y protector de dedos ergonómico que evita el contacto con las cuchillas durante el uso.
- Rampa de deslizamiento con superficie acanalada para evitar que se peguen los alimentos.
- Fácil de limpiar, cuchilla desmontable

- Bidirectional mandoline with a stainless steel blade and body made of top quality, BPA free materials.
- Extremely sharp blades that give an even and precise cut.
- Two types of cut: 1 mm thin and 3 mm thick (Ref.: 60275). Julienne cut of 3x3 mm section (Ref.: 60276).
- Practical and compact design.
- DoubleCut System: Save up to 50% time because it cuts in both directions.
- Safe Cut: Non-slip base and ergonomic finger guard that prevents contact with the blades during use.
- Sliding ramp with a corrugated surface that keeps food from sticking.
- Easy to clean, removable blade.

Máquinas de corte



- Aumenta la productividad disminuyendo el tiempo de trabajo frente a sistemas convencionales.
- Gama de corte profesional con 4 modelos de corte manual. Con un diseño robusto y ergonómico, gracias a sus cuchillas de acero inoxidable (resistentes a la corrosión), aseguran un corte uniforme y de gran calidad. Ideales para cualquier cocina industrial, su fácil manejo permite obtener un óptimo rendimiento con el mínimo esfuerzo.

- Augmente la productivité et diminue le temps de travail par rapport aux systèmes conventionnels.
- Gamme de coupe professionnelle avec 4 modèles de coupe manuelle. Avec une conception robuste et ergonomique, notamment grâce aux lames en acier inoxydable (résistantes à la corrosion), ils garantissent une coupe uniforme et de grande qualité. Ils s'adaptent parfaitement aux différents types de cuisine industrielle et la facilité de manipulation permet d'obtenir un rendement optimal avec le moindre effort.

- Increases productivity by reducing working time when compared to conventional systems.
- Range of professional cutting Utensils with 4 manual cutting models. With a robust and ergonomic design, its stainless steel (corrosion resistant) blades ensure a smooth and high quality cut. Ideal for any Industrial kitchen, their ease of use enables optimum performance with minimum effort.

- Asa de gran robustez para transportar la máquina.
- 10 cuchillas para un perfecto laminado.
- Bandeja recogelaminados. Ventosas de sujeción.

- Colóquelo donde quiera (mesa-pared-tabla).
- 4 cuchillas diferentes: 7x7 mm / 10x10 mm / 15x15 mm / 8 gajos.
- Estructura desmontable y fácil limpieza.

- Great robustness handle to transport the machine.
- 10 blades for a perfect laminate.
- Collection tray. Suction suction.

- Place wherever (table-play-table).
- 4 Different Cuchlas: 7x7 mm / 10x10 mm / 15x15 mm / 8 segments.
- Structure Disassemble and easy cleaning.



Máquina corta tomates

Machine pour couper tomates · Tomatenschneider
Tomato cutter machine · Máquina cortador tomate

| Ref | € | Espesor corte | cm | U.Venta |
|-------|--------|---------------|----------|---------|
| 60510 | 254,80 | 5,5 | 43x20x21 | 1 |

- Colóquelo donde quiera (mesa-encimera-tabla).
- 3 cuchillas diferentes; 6x6 mm / 8x8 mm / 10x10 mm.
- Estructura desmontable y fácil limpieza.

- Place it wherever you want (Table-Encimera-Tabla).
- 3 different blades; 6x6 mm / 8x8 mm / 10x10 mm.
- Detachable structure and easy cleaning.

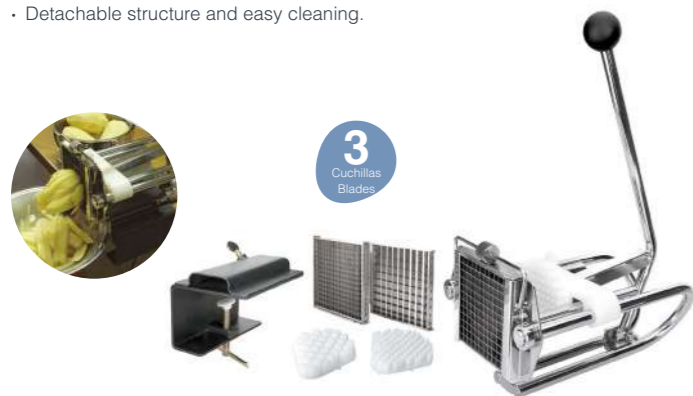

Corta patatas chips

Coupe-Frites 3 Lames · Pommes Frites-Schneider, 3 Klingen
Potato Chips Cutter 3 Blades · Corta-batatas chip 3 cortadores

| Ref | € | Cubos (mm) | U.Venta |
|-------|--------|-------------------|---------|
| 60343 | 216,20 | 6x6 / 8x8 / 10x10 | 1 |



Máquina corta patatas y gajos

Machine pour chips trancheuse et wedger · Pommes Frites und Wedger-Schneider
Potato chips slicer and wedger machine · Máquina cortador batatas e gomos

| Ref | € | Cubos (mm) | Gajos | cm | U.Venta |
|-------|--------|---------------------|-------|----------|---------|
| 60513 | 229,50 | 7x7 / 10x10 / 15x15 | 8 | 26x26x42 | 1 |

- Amortiguadores para evitar golpes al cortar los alimentos.
- Asa empujador robusta para un mejor manejo.
- Patas de goma para una mejor sujeción.

- Shock absorbers to avoid blows when cutting food.
- Robust pushing for better handling.
- Rubber legs for better support.



Máquina corta patatas vertical

Machine pour chips trancheuse vertical · Pommes Frites-Schneider vertikal
Vertical chips slicer machine · Máquina cortador batatas vertical

| Ref | € | Cubos (mm) | cm | h(cm) | U.Venta |
|-------|--------|------------|-------|-------|---------|
| 60511 | 181,70 | 10x10 | 20x20 | 48 | 1 |

Guillotina para embutidos



Guillotina para embutidos

Guillotine à saucisson · Wurtschneider
Cold meat guillotine · Guillotina para embutidos

| Ref | € | cm | h(cm) | U.Venta |
|-------|-------|-------|-------|---------|
| 60559 | 21,80 | 29x19 | 10,5 | 1 |

- Diseñada para cortar y rebanar todo tipo de embutidos (Ø 5,5 cm máx.) de forma rápida, segura y sin esfuerzo.
- Cuchilla de acero inoxidable muy aillada de máxima calidad.
- Mango ergonómico que garantiza un agarre fácil y cómodo.
- Máxima seguridad gracias al pasador protector con imán.
- 100% estable. Dispone de 7 almohadillas de goma antideslizantes en la base.

- Conçu pour couper et trancher toutes sortes de saucisses (Ø 5,5 cm max.) Rapidement, en toute sécurité et sans effort.
- Blade en acier inoxydable très Aillada de qualité maximale.
- Mango ergonomique qui garantit une poignée facile et confortable.
- Sécurité maximale grâce à la broche de protection avec aimant.
- 100% stable. Il a 7 coussinets en caoutchouc non glissants à la base.

- Designed to cut and slice all kinds of sausages (Ø 5.5 cm max.) Quickly, safely and effortlessly.
- Very aillada stainless steel blade of maximum quality.
- Ergonomic mango that guarantees an easy and comfortable grip.
- Maximum security thanks to the protective pin with magnet.
- 100% stable. It has 7 non-slip rubber pads at the base.

Jamonero



Tacos antideslizantes
Non slip plugs

Jamonero

Support pour jambon · Schinkenhalter
Ham-support · Suporte presunto

| Ref | € | cm | h(cm) | U.Venta |
|-------|-------|---------|-------|---------|
| 62344 | 94,40 | 50x20,5 | 35,5 | 1 |



Plegable
Folding

Tacos antideslizantes
Non slip plugs

Jamonero abatible

Support pour jambon rabattable · Schinkenhalter, Verstellbar
Folden ham-support · Suporte presunto abatible

| Ref | € | cm | h(cm) | U.Venta |
|-------|-------|-------|-------|---------|
| 62359 | 92,80 | 43x19 | 5 | 1 |

Tabla de corte Carnicero



- Fabricada en polietileno de alta densidad. Espesor de 5 mm.
- Su dureza le confiere una mayor resistencia a la abrasión, durabilidad y una gran absorción de los golpes.
- Material no poroso que facilita su limpieza. No acumula olores ni sabores.
- Apta para lavavajillas.
- Cumple con todas las garantías sanitarias para la manipulación de alimentos exigidas por la unión europea.

- Fabriqué en polyéthylène de haute densité. Épaisseur de 5 mm.
- Sa dureté lui confère une plus grande résistance à l'abrasion, et une durabilité et une absorption des chocs accrues.
- Matériau non poreux qui facilite son nettoyage. Ne garde ni les odeurs ni les goûts.
- Apte pour le lave-vaisselle.
- Répond à toutes les garanties sanitaires pour la manipulation d'aliments exigées par l'Union Européenne.

Tabla de corte Carnicero

Planche à découper la viande · Metzger-Schneidblock
Butcher Block · Cepo de corte de carneiro

| Ref | € | cm | h(cm) | U.Venta |
|-------|--------|-------|-------|---------|
| 60578 | 179,30 | 50x50 | 5,0 | 1 |

- Made of high density polyethylene 5 mm thick.
- Its hardness gives it greater resistance to abrasion, more durability and high impact absorption.
- The non-porous material makes it easy to clean. There is no build-up of odours or flavours.
- Dishwasher safe.
- Meets all health guarantee for food handling required by the European Union.

Protección guantes y delantal

Composición · Composition:
62% Polietileno / 62% Polyethylene
24% Poliéster / 24% Polyester
14% Fibra de vidrio / 14% Glass fiber

2
PCS



EN 388:2016+1:2018



344 XC

CE certificate issued by CTC FRANCE

Resistencia a la abrasión
Abrasion resistance **3**

Resistencia al corte
Blade cut resistance **4**

Resistencia al PDM
PDM resistance **C**

Resistencia al desgarro
Tear resistance **4**

- Ambidiestros, cómodo y ligero.
- **NO** emplear con sierras giratorias o dentadas.

- Ambidextres, pratiques et légers.
- **NE PAS** utiliser avec des scies giratoires ou dentées.

- Ambidextrous, comfortable and light.
- Do **NOT** use with rotating or toothed saws.



UNE EN 1082

CE Directive 89/686/EEC and EN 1082-1-1996

- Guante de cinco dedos con correa en la muñeca.
- Reversible para mano derecha como izquierda.
- Diseño de correa extraíble y protección completa de mano.
- Fácil de lavar y desinfectar.

- Cinq doigts avec une sangle de poignet.
- Réversible pour la main droite à gauche.
- Conception de ceinture extractible et protection des mains complètes.
- Facile à laver et à désinfecter.

- Five fingers with a wrist strap.
- Reversible for right hand as left.
- Extractable belt design and full hand protection.
- Easy to wash and disinfect.

Ideal para uso en mandolinas profesionales
Ideal for use in professional mandolins



UNE EN 1082
EN ISO 13998: 2003
NIVEL / LEVEL: 2

- Ajustable gracias a sus tirantes verticales y horizontales.
- Conviene asegurarse de que las medidas del cuchillo empleado no sean inferiores a: 20x12,5mm

- Réglable grâce à ses accolades verticales et horizontales.
- Il convient de s'assurer que les mesures du couteau utilisées ne sont pas inférieures à: 20x12,5 mmmmm

- Adjustable thanks to its vertical and horizontal braces.
- It should be ensured that the measures of the knife used are not less than: 20x12.5mm

Guante protección

Gant de protection · Schutzhandschuh
Protection glove · Luva de protecção

| Ref | € | Talla | Medidas | Perímetro mano | Largo (cm) | U.Venta |
|-------|-------|-------|---------|----------------|------------|---------|
| 61101 | 20,00 | M | 8 | 182 mm | 24 | 1 |
| 61102 | 20,00 | L | 9 | 192 mm | 25 | 1 |
| 61103 | 20,00 | XL | 10 | 204 mm | 26 | 1 |



INOX

Guante Cota

Gant en maille · Netz-Handschuh
Chainman glove · Luva de malha

| Ref | € | Talla | Medidas | Perímetro mano | Color | U.Venta |
|-------|--------|-------|---------|----------------|------------------|---------|
| 39169 | 142,90 | S | 7 | 171 mm | Blanco · White | 1 |
| 39170 | 142,90 | M | 8 | 182 mm | Rojo · Red | 1 |
| 39171 | 142,90 | L | 9 | 192 mm | Azul · Blue | 1 |
| 39172 | 142,90 | XL | 10 | 204 mm | Naranja · Orange | 1 |



INOX

Delantal cota de malla

Tablier en maille · Kettenhemb Schürze
Metal butcher's apron · Avental de malha

| Ref | € | cm | Perímetro (cm) | U.Venta |
|-------|--------|-------|----------------|---------|
| 39165 | 331,20 | 80x55 | 95-145 | 1 |

Colección Etern

INOX PP
Polypropylene BPA free

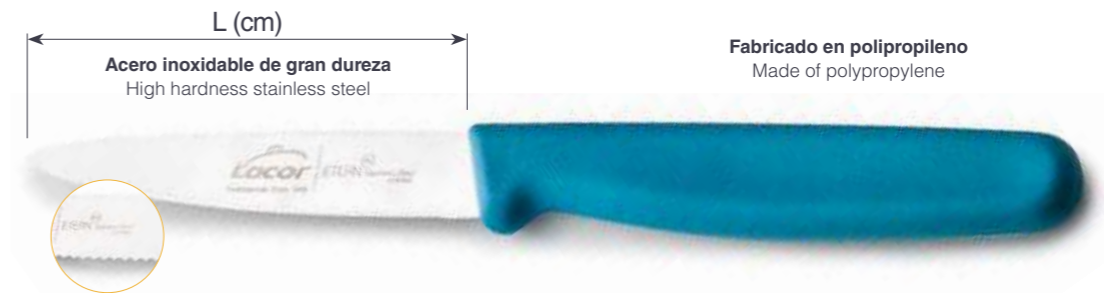

Filo liso o dentado
Plain or serrated edge

Filo estrecho y delgado.
Precisión en el corte
Thin cutting edge for precise cutting

Fabricado en polipropileno
Made of polypropylene

Se adapta a la mano cómodamente
Ergonómico y antideslizante
Handle for excellent grip during use



Etern Ocean

| | Ref | € | Largo (cm) | U.Venta |
|---|-------|------|------------|---------|
| A | 39220 | 3,40 | 9,0 | 1 |
| | 39223 | 3,50 | 10,0 | 1 |
| B | 39221 | 3,40 | 9,0 | 1 |
| | 39224 | 3,50 | 10,0 | 1 |
| C | 39226 | 3,50 | 10,5 | 1 |
| D | 39227 | 3,50 | 11,0 | 1 |

Cuchillo liso · Plain knife

Cuchillo dentado · Serrated knife

Cuchillo mesa · Table knife

Cuchillo chuletero · Steak knife



Pelador universal

Éplucheur Universel · Universal-Schälmesser
Universal peeler · Descascador Universal

| | Ref | € | cm | Largo (cm) | U.Venta |
|---|-------|------|-----|------------|---------|
| A | 39088 | 5,90 | 1x5 | 17 | 1 |
| B | 39089 | 5,90 | 1x5 | 17 | 1 |
| C | 39090 | 5,90 | 1x5 | 17 | 1 |

Etern Magenta

| | Ref | € | Largo (cm) | U.Venta |
|---|-------|------|------------|---------|
| A | 39230 | 3,40 | 9,0 | 1 |
| | 39233 | 3,50 | 10,0 | 1 |
| B | 39231 | 3,40 | 9,0 | 1 |
| | 39234 | 3,50 | 10,0 | 1 |
| C | 39236 | 3,50 | 10,5 | 1 |
| D | 39237 | 3,50 | 11,0 | 1 |

Cuchillo liso · Plain knife

Cuchillo dentado · Serrated knife

Cuchillo mesa · Table knife

Cuchillo chuletero · Steak knife



Pelador Fast

Éplucheur · Schälmesser
Peeler · Descascador

| | Ref | € | cm | Largo (cm) | U.Venta |
|---|-------|------|-------|------------|---------|
| A | 39091 | 5,90 | 4,5x1 | 11 | 1 |
| B | 39092 | 5,90 | 4,5x1 | 11 | 1 |
| C | 39093 | 5,90 | 4,5x1 | 11 | 1 |

Colección Select

new

INOX TPV
Plastic

- El color del mango identifica al cuchillo y garantiza un control higiénico-sanitario tal como especifican las normas europeas sanitarias de control alimentario.
- Hoja fabricada en acero inoxidable de máxima dureza y durabilidad, gracias a un correcto tratamiento térmico.
- Su forma convexa en ambas caras ofrece un filo muy afilado para un corte firme y equilibrado.
- Mango ergonómico y antideslizante fabricado en TPV. Ofrece una gran resistencia, adherencia y confort.

- La couleur du manche identifie le couteau et garantit un contrôle hygiénique et sanitaire conformément aux normes européennes de sécurité alimentaire.
- La lame est fabriquée en acier inoxydable d'une dureté et d'une durabilité maximales, grâce à un traitement thermique approprié.
- Sa forme convexe des deux côtés offre un bord très tranchant pour une coupe ferme et équilibrée.
- Manche ergonomique et antidérapant en TPV. Il offre une grande résistance, une bonne prise en main et un grand confort.

- The colour of the handle identifies the knife and guarantees a hygienic-sanitary control as specified by the European food safety standards.
- The blade is made of stainless steel of maximum hardness and durability, thanks to a correct heat treatment.
- Its convex shape on both sides offers a very sharp edge for a firm and balanced cut.
- Ergonomic, non-slip handle made of TPV. It offers great resistance, grip and comfort.



Carnes rojas
Red meat



Pescados y mariscos
Fish and seafood



Carnes blancas y aves
White meat and poultry



Verduras y frutas
Vegetables and fruits



Embutidos y fiambres
Sausages and cold meats



Pastelería y lácteos
Patisserie and dairy



Alimentos sin alérgenos
Food allergen-free

Hoja fabricada en acero inoxidable de máxima dureza y durabilidad

HBlade made of stainless steel for maximum hardness and durability



Su forma convexa en ambas caras ofrecen un filo muy afilado para un corte firme y equilibrado

The convex shape on both sides provides a very sharp edge for a firm and balanced cut

Mango ergonómico y antideslizante fabricado en TPV.

Ergonomic, non-slip handle made of TPV



| Ref | € | cm | U.Venta |
|----------------|--------------|------|---------|
| A 38301 | 16,20 | 20,0 | 1 |
| B 38311 | 17,50 | 25,0 | 1 |
| C 38330 | 15,10 | 17,5 | 1 |
| D 38340 | 11,50 | 12,5 | 1 |



| Ref | € | cm | U.Venta |
|----------------|--------------|------|---------|
| A 38303 | 16,20 | 20,0 | 1 |
| B 38313 | 17,50 | 25,0 | 1 |
| C 38322 | 16,20 | 30,5 | 1 |
| D 38342 | 11,50 | 12,5 | 1 |
| E 38361 | 6,00 | 10,0 | 1 |
| F 38371 | 8,50 | 15,0 | 1 |



| Ref | € | cm | U.Venta |
|----------------|--------------|------|---------|
| A 38302 | 16,20 | 20,0 | 1 |
| B 38312 | 17,50 | 25,0 | 1 |
| C 38331 | 15,10 | 17,5 | 1 |
| D 38341 | 11,50 | 12,5 | 1 |
| E 38360 | 6,00 | 10,0 | 1 |
| F 38370 | 8,50 | 15 | 1 |



| Ref | € | cm | U.Venta |
|----------------|--------------|------|---------|
| A 38304 | 16,20 | 20,0 | 1 |
| B 38315 | 17,50 | 25,0 | 1 |
| C 38350 | 5,60 | 9,0 | 1 |
| D 38362 | 6,00 | 10,0 | 1 |
| D 38380 | 8,50 | 15,0 | 1 |



| Ref | € | cm | U.Venta |
|----------------|--------------|------|---------|
| A 38300 | 16,20 | 20,0 | 1 |
| B 38310 | 17,50 | 25,0 | 1 |
| C 38321 | 16,20 | 30,5 | 1 |
| D 38391 | 17,70 | 30,5 | 1 |



| Ref | € | cm | U.Venta |
|----------------|--------------|------|---------|
| A 38305 | 16,20 | 20,0 | 1 |
| B 38316 | 17,50 | 25,0 | 1 |
| C 38332 | 15,10 | 17,5 | 1 |
| D 38363 | 6,00 | 10,0 | 1 |
| E 38381 | 8,50 | 15,0 | 1 |



| Ref | € | cm | U.Venta |
|----------------|--------------|------|---------|
| A 38314 | 17,50 | 25,0 | 1 |
| B 38390 | 14,70 | 25,0 | 1 |



Colección Elite

INOX

- Fabricados en acero inoxidable de alta calidad con una composición de 5Cr15 y una dureza 55±2.
- Hojas muy afiladas y resistentes al desgaste. Filos acabados en taper grinding.
- Mangos ergonómicos y antideslizantes en ABS con acero inoxidable, proporcionan un excelente agarre durante el uso.
- Ideales tanto para uso doméstico como profesional.
- Diseñados para el corte y manipulación de cualquier tipo de carne, pescado, verdura, fruta, patatas, etc.

- Fabriqué en acier inoxydable de grande qualité avec une composition de 5Cr15 et une dureté de 55±2.
- Lame très aiguisée et résistante à l'usure. Fil finition « taper grinding ».
- Manche ergonomique et antidérapant en ABS avec acier inoxydable, qui confère une excellente prise en main pendant l'utilisation.
- Idéal aussi bien pour un usage domestique que professionnel.
- Conçu pour couper et manipuler tout type de viandes, poissons, légumes, fruits, pommes de terre, etc.

- Made of high quality stainless steel with a composition of 5Cr15 and hardness of 55±2.
- Extremely sharp and wear resistant edge Taper ground edge.
- The ABS ergonomic non-slip handle with stainless steel provides an excellent grip during use.
- Perfect for home or professional use.
- Designed for cutting and manipulating any kind of meat, fish, vegetables, fruit or potatoes, etc.



Cuchillo pelador

Couteau éplucheuse · Schäler Messer
Peeler knife · Faca descascador

| Ref | € | cm | U.Venta |
|-------|-------|-----|---------|
| 38225 | 10,00 | 9,0 | 1 |



Cuchillo cocina

Couteau de cuisine · Küchenmesser
Kitchen knife · Faca cozinha

| Ref | € | cm | U.Venta |
|-------|-------|------|---------|
| 38224 | 10,10 | 12,5 | 1 |



Cuchillo Santoku

Couteau Santoku · Messer Santoku
Santoku knife · Faca Santoku

| Ref | € | cm | U.Venta |
|-------|-------|------|---------|
| 38223 | 16,30 | 18,0 | 1 |



Cuchillo fileteador

Couteau filet-de-sole · Filiermesser
Filetting/fish knife · Faca peixe / filetes

| Ref | € | cm | U.Venta |
|-------|-------|------|---------|
| 38221 | 14,90 | 20,0 | 1 |



Cuchillo pan

Couteau à pain · Brotmesser
Bread knife · Faca de pão

| Ref | € | cm | U.Venta |
|-------|-------|------|---------|
| 38222 | 14,90 | 20,0 | 1 |



Cuchillo Chef

Couteau Chef · Messer Chef
Chef knife · Faca Chef

| Ref | € | cm | U.Venta |
|-------|-------|------|---------|
| 38220 | 16,10 | 20,0 | 1 |

Colección Master

INOX

- Fabricados en acero inoxidable de alta calidad con una composición de 5Cr15 y una dureza 55±2.
- Hojas muy afiladas y resistentes al desgaste. Filos acabados en taper grinding.
- Mangos ergonómicos y antideslizantes en ABS con acero inoxidable, proporcionan un excelente agarre durante el uso.
- Ideales tanto para uso doméstico como profesional.
- Diseñados para el corte y manipulación de cualquier tipo de carne, pescado, verdura, fruta, patatas, etc.

- Fabriqué en acier inoxydable de grande qualité avec une composition de 5Cr15 et une dureté de 55±2.
- Lame très aiguisée et résistante à l'usure. Fil finition « taper grinding ».
- Manche ergonomique et antidérapant en ABS avec acier inoxydable, qui confère une excellente prise en main pendant l'utilisation.
- Idéal aussi bien pour un usage domestique que professionnel.
- Conçu pour couper et manipuler tout type de viandes, poissons, légumes, fruits, pommes de terre, etc.

- Made of high quality stainless steel with a composition of 5Cr15 and hardness of 55±2.
- Extremely sharp and wear resistant edge Taper ground edge.
- The ABS ergonomic non-slip handle with stainless steel provides an excellent grip during use.
- Perfect for home or professional use.
- Designed for cutting and manipulating any kind of meat, fish, vegetables, fruit or potatoes, etc.



Cuchillo pelador

Couteau éplucheuse · Schäler Messer
Peeler knife · Faca descascador

| Ref | € | cm | U.Venta |
|-------|------|-----|---------|
| 38235 | 6,40 | 9,0 | 1 |



Cuchillo cocina

Couteau de cuisine · Küchenmesser
Kitchen knife · Faca cozinha

| Ref | € | cm | U.Venta |
|-------|------|------|---------|
| 38234 | 6,50 | 12,5 | 1 |



Cuchillo Santoku

Couteau Santoku · Messer Santoku
Santoku knife · Faca Santoku

| Ref | € | cm | U.Venta |
|-------|-------|------|---------|
| 38233 | 10,90 | 18,0 | 1 |



Cuchillo fileteador

Couteau filet-de-sole · Filiermesser
Filetting/fish knife · Faca peixe / filetes

| Ref | € | cm | U.Venta |
|-------|------|------|---------|
| 38231 | 9,60 | 20,0 | 1 |



Cuchillo pan

Couteau à pain · Brotmesser
Bread knife · Faca de pão

| Ref | € | cm | U.Venta |
|-------|------|------|---------|
| 38232 | 9,60 | 20,0 | 1 |



Cuchillo Chef

Couteau Chef · Messer Chef
Chef knife · Faca Chef

| Ref | € | cm | U.Venta |
|-------|-------|------|---------|
| 38230 | 10,80 | 20,0 | 1 |

Colección Classic



Dishwasher

- Cuchillos forjados realizados en una sola pieza.
- Fabricados en acero inoxidable X 45 Cr Mo V 15. Dureza de 54-58 HRC.
- Mango ergonómico.
- Remaches resistentes a la corrosión.
- Cuchillo estable, fuerte y de gran durabilidad.

- Couteaux forgés réalisés en une seule pièce.
- Fabriqués en acier inoxydable X 45 Cr Mo V 15. Dureté 54-58 Hc.
- Manche ergonomique.
- Rivets résistants à la corrosion.
- Couteau stable, solide et d'une grande durabilité.

54-58 MOLYBDÄNSTAHL Cuchillo forjado

HRC X 45 Cr Mo V 15 Forged knives

Acero inoxidable al cromo-molibdeno-vanadio
Chrome-molybdenum-vanadium stainless steel

- One-piece forged knives.
- Made with X 45 Cr Mo V 15 stainless steel. 54-58 Hc hardness.
- Ergonomic handle.
- Corrosion resistant rivets.
- A stable, strong and extremely durable knife.



Cuchillo Chef

Couteau de cuisine · Messer Chef
Cook's knife · Faca Chef

| Ref | € | cm | U.Venta |
|-------|-------|----|---------|
| 39016 | 20,60 | 16 | 1 |
| 39021 | 25,50 | 21 | 1 |
| 39025 | 29,00 | 25 | 1 |
| 39030 | 37,20 | 30 | 1 |



Cuchillo cocina

Couteau de cuisine · Küchenmesser
Kitchen knife · Faca cozinha

| Ref | € | cm | U.Venta |
|-------|-------|----|---------|
| 39110 | 10,60 | 10 | 1 |
| 39112 | 12,00 | 12 | 1 |
| 39114 | 13,60 | 14 | 1 |
| 39116 | 16,40 | 16 | 1 |
| 39118 | 18,40 | 18 | 1 |
| 39121 | 19,20 | 21 | 1 |
| 39125 | 20,60 | 25 | 1 |



Cuchillo pescado / fileteador

Couteau filet-de-sole · Filiermesser
Filleting/fish knife · Faca peixe / filetes

| Ref | € | cm | U.Venta |
|-------|-------|----|---------|
| 39115 | 13,60 | 20 | 1 |



Cuchillo deshuesador

Couteau à désosser · Ausbeinmesser
Boning knife · Faca desossador

| Ref | € | cm | U.Venta |
|-------|-------|----|---------|
| 39014 | 16,40 | 14 | 1 |



Cuchillo patatero

Couteau office · Gemüsemesser
Paring knife · Faca batatas

| Ref | € | cm | U.Venta |
|-------|-------|------|---------|
| 39185 | 11,20 | 8,50 | 1 |



Cuchillo jamonero

Couteau à jambon · Schinkenmesser
Ham knife · Faca de presunto

| Ref | € | cm | U.Venta |
|-------|-------|----|---------|
| 39020 | 21,40 | 21 | 1 |
| 39024 | 24,00 | 26 | 1 |



Cuchillo pan

Couteau à pain · Brotmesser
Bread knife · Faca de pão

| Ref | € | cm | U.Venta |
|-------|-------|----|---------|
| 39027 | 19,30 | 21 | 1 |



Cuchillo congelados

Couteau aliments surgelés · Gefrierwarenmesser
Frozen food knife · Faca congelados

| Ref | € | cm | U.Venta |
|-------|-------|----|---------|
| 39028 | 20,10 | 21 | 1 |



Tenedor de trinchar

Fourchette de chef · Tranchiergabel
Cook's fork · Garfo de trinchar

| Ref | € | cm | U.Venta |
|-------|-------|----|---------|
| 39017 | 17,20 | 18 | 1 |



Machete

Couperet · Hackfleischmesser
Cleaver · Cutelo

| Ref | € | cm | U.Venta |
|-------|-------|----|---------|
| 39015 | 59,00 | 16 | 1 |



Macheta

Couperet · Hackfleischmesser
Cleaver · Cutelo

| Ref | € | cm | U.Venta |
|-------|-------|------|---------|
| 39018 | 21,90 | 17x8 | 1 |



Macheta para pescado

Couperet à poisson · Sehr Scharfes fischmesser
Fish cleaver · Cutelo para peixe

| Ref | € | cm | U.Venta |
|-------|-------|----|---------|
| 39029 | 22,60 | 29 | 1 |



Chaira

Fusil à affûter · Wetzstahl
Sharpening steel · Fusil

| Ref | € | Largo (cm) | U.Venta |
|-------|-------|------------|---------|
| 39010 | 21,60 | 21 | 1 |

Taco 5 cuchillos Chef

5 couteau de Bloc · 5 Messer Set
5 knife block · Taco 5 facas

| Ref | € | Largo (cm) | U.Venta |
|-------|-------|------------|---------|
| 39064 | 66,80 | 20 | 1 |



COMPOSICIÓN (6 pcs.):

- * Cuchillo Chef 21 cm (39021)
- * Cuchillo de cocina de 10 cm (39110)
- * Cuchillo de cocina de 16 cm (39116)
- * Cuchillo deshuesador 14 cm (39014)
- * Cuchillo jamonero 20 cm (39020)
- * Chaira (39010)

COMPOSICIÓN (8 pcs.):

- * Cuchillo Chef 21 cm (39021)
- * Cuchillo de cocina de 10 cm (39110)
- * Cuchillo de cocina de 16 cm (39116)
- * Cuchillo deshuesador 14 cm (39014)
- * Cuchillo jamonero 20 cm (39020)
- * Cuchillo pan (39027)
- * Tenedor trinchar (39017)
- * Chaira (39010)



Taco 6/8 piezas

6/8 pcs bloc · Messerhalter Set, 6/8-tlg
6/8 pc bloc · Taco 6/8 peças

| Ref | € | Piezas | U.Venta |
|-------|--------|--------|---------|
| 39000 | 135,10 | 6 | 1 |
| 39001 | 165,30 | 8 | 1 |



Maleta 9 piezas

9 pcs mallette de chef · Messertasche, 9-tlg
9 pc cook's case · Mala 9 peças

| Ref | € | U.Venta |
|-------|--------|---------|
| 39004 | 357,10 | 1 |

COMPOSICIÓN:

- * Cuchillo de cocina de 10 cm (39110)
- * Cuchillo de cocina de 18 cm (39118)
- * Cuchillo de cocina de 25 cm (39125)
- * Cuchillo deshuesador 14 cm (39014)
- * Cuchillo jamonero 20 cm (39020)
- * Cuchillo Chef 25 cm (39025)
- * Tenedor trinchar (39017)
- * Macheta (39015)
- * Chaira (39010)

Colección Profesional

INOX 
Dishwasher

- Cuchillo estampado.
- Fabricado en acero inoxidable al cromo-molibdeno-vanadio X 45 Cr Mo V 15. Dureza de 54-58 HRc.
- Cuchillo estable, fuerte y de gran durabilidad.
- Mango ergonómico antideslizante, tacto suave Soft Touch.

- Couteau estampé.
- Fabriqué en acier inoxydable au chrome-molybdène -vanadium X 45 Cr Mo V 15. Dureté de 54-58 HRc.
- Couteau stable, robuste et d'une grande durabilité.
- Manche ergonomique antidérapant, toucher doux Soft Touch.

54-58 MOLYBDÄNSTAHL Mango Antideslizante
HRc X 45 Cr Mo V 15 Non-slip long handle knives
Acero inoxidable al cromo-molibdeno-vanadio
Chrome-molybdenum-vanadium stainless steel

- Stamped Knife.
- Made of X 45 Cr Mo V 15 chromium-vanadium stainless steel. 54-58 HRc Hardness.
- A stable, strong and durable knife.
- Non-slip ergonomic handle, smooth Soft Touch feel.



Cuchillo Chef
Couteau de chef · Messer Chef
Cook's knife · Faca Chef

| Ref | € | cm | U.Venta |
|-------|-------|----|---------|
| 49016 | 7,10 | 16 | 12 |
| 49021 | 10,50 | 21 | 12 |
| 49025 | 12,30 | 25 | 12 |
| 49030 | 13,40 | 30 | 12 |



Cuchillo cocina
Couteau de cuisine · Küchenmesser
Kitchen knife · Faca cozinha

| Ref | € | cm | U.Venta |
|-------|------|----|---------|
| 49110 | 4,90 | 10 | 12 |
| 49112 | 4,90 | 12 | 12 |
| 49116 | 5,70 | 16 | 12 |
| 49121 | 7,40 | 21 | 12 |



Cuchillo patatero
Couteau office · Gemüsemesser
Paring knife · Faca batatas

| Ref | € | cm | U.Venta |
|-------|------|------|---------|
| 49185 | 4,40 | 8,50 | 12 |



Cuchillo deshuesador
Couteau à désosser · Ausbeinmesser
Boning knife · Faca desossador

| Ref | € | cm | U.Venta |
|-------|------|----|---------|
| 49014 | 5,40 | 14 | 12 |



Cuchillo jamonero
Couteau à jambon · Schinkenmesser
Ham knife · Faca de presunto

| Ref | € | cm | U.Venta |
|-------|------|----|---------|
| 49024 | 8,40 | 26 | 12 |



Cuchillo pan
Couteau à pain · Brotmesser
Bread knife · Faca de pão

| Ref | € | cm | U.Venta |
|-------|------|----|---------|
| 49027 | 7,60 | 21 | 12 |



Tenedor para trinchar
Fourchette de chef · Tranchiergabel
Cook's fork · Garfo de trinchar

| Ref | € | cm | U.Venta |
|-------|------|----|---------|
| 49017 | 6,60 | 18 | 12 |



Cuchillo Santoku
Couteau Santoku · Messer Santoku
Santoku knife · Faca Santoku

| Ref | € | cm | U.Venta |
|-------|-------|----|---------|
| 49210 | 6,60 | 10 | 12 |
| 49212 | 8,00 | 12 | 12 |
| 49216 | 11,00 | 16 | 12 |

Colección Ceramic

CE 
Ceramic Dishwasher

- Mango ergonómico antideslizante con un diseño moderno e innovador.
- Resistente, ligero e higiénico.
- NO oxida los alimentos.
- El filo se mantiene hasta diez veces más que los cuchillos convencionales.

- Mangue ergonomique non glissante avec un design moderne et innovant.
- Résistant, léger et hygiénique.
- Ne pas oxyder les aliments.
- Le bord reste jusqu'à dix fois plus que les couteaux conventionnels.

- Ergonomic non -slip mango with a modern and innovative design.
- Resistant, light and hygienic.
- Do not oxidize food.
- The edge remains up to ten times more than conventional knives.



Cuchillo cocina
Couteau de cuisine · Küchenmesser
Kitchen knife · Faca cozinha

| | Ref | € | cm | U.Venta |
|---|-------|-------|----|---------|
| A | 39208 | 11,00 | 8 | 1 |
| B | 39210 | 12,00 | 10 | 1 |
| C | 39212 | 20,30 | 12 | 1 |
| D | 39215 | 26,40 | 15 | 1 |
| E | 39218 | 39,10 | 18 | 1 |
| F | 39213 | 24,40 | 12 | 1 |



Chiara Diamante
Fusil à affûter · Wetzstahl
Sharpening steel · Fusil

| Ref | € | cm | U.Venta |
|-------|-------|----|---------|
| 39075 | 36,60 | 21 | 1 |

Cuchillos Mesa

INOX  Dishwasher

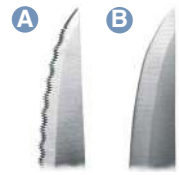

Set de 6 cuchillos chuleteros
6 couteau steak · 6 steakmesser,
6 pcs steak knives · Conjunto 6 facas carne

| | Ref | € | Largo (cm) | U.Venta |
|---|-------|-------|------------|---------|
| A | 39060 | 15,80 | 21 | 12 |
| B | 39061 | 15,10 | 21 | 12 |

- Set de 6 cuchillos chuleteros microdentados fabricados en acero inoxidable de gran calidad.
- Gran resistencia y durabilidad, ideal para el uso diario.
- Diseñado especialmente para cortar todo tipo de carnes.
- Mango ergonómico de madera de gran resistencia y durabilidad con líneas redondeadas que ofrecen un agarre cómodo y seguro. Medidas: 21,5 cm de longitud y tamaño de la hoja: 10,5 cm.

- Set of 6 micro serrated steak knives made of high quality stainless steel
- Extremely strong and durable, perfect for daily use specially designed for cutting all kinds of meat.
- It has an extremely strong and durable ergonomic wooden handle with curved lines that give a comfortable and safe grip. Measurements: 21.5 cm long and blade size: 10.5 cm

6 pcs

Set de cuchillos chuleteros Wood
6 couteau steak · 6 steakmesser,
6 pcs steak knives · Conjunto 6 facas carne

| | Ref | € | cm | U.Venta |
|--|-------|-------|------|---------|
| | 38240 | 15,70 | 10,5 | 1 |



- new**
- Set de 6 cuchillos microdentados fabricados de una sola pieza en acero inoxidable de gran calidad.
 - Cuentan con un filo de sierra y punta afilada, ideal para cortar todo tipo de alimentos sin ninguna dificultad.
 - Gran resistencia y durabilidad, perfecto para el uso diario. Mango ergonómico que ofrece un agarre cómodo y seguro.
 - Medidas: 22 cm de longitud. Tamaño de la hoja: 11 cm.

- Set of 6 micro serrated knives made in one piece of high quality stainless steel.
- It has a serrated edge and sharp point, ideal for cutting all types of food without any difficulty.
- Extremely strong and durable, perfect for daily use. Ergonomic handle that give a comfortable and safe grip.
- Measurements: 22 cm long. Blade size: 11 cm.

A Dentado · Serrated



B Liso · Plain



Set de cuchillos Monoblock
Ensemble de couteaux · Satz Messer
knife set · Conjunto de facas

| | Ref | € | cm | U.Venta |
|---|-------|-------|----|---------|
| A | 38241 | 22,40 | 22 | 1 |
| B | 38242 | 22,40 | 22 | 1 |

6 pcs

Acero inoxidable 54-58

X 50 Cr Mo V 15 HRc

Acero inoxidable al cromo-molibdeno-vanadio
Chrome-molybdenum-vanadium stainless steel

Colección cortaquesos

 Dishwasher

Bisel plano de altura completa con forma de V
Full height V-shaped flat bevel

Taper Grinding

Reducción uniforme de la hoja desde el lomo consiguiendo un filo fuerte y duradero.
Gradually reduction width from the spine resulting in a strong and durable cutting edge.



Cuchillo cortaquesos Classic
Couteau à fromage · Käseschneidmesser
Cheese slicing knife · Faca para cortar queijo

| | Ref | € | cm | U.Venta |
|--|-------|-------|----|---------|
| | 39100 | 46,40 | 30 | 1 |



Cuchillo cortaquesos Profesional
Couteau à fromage · Käseschneidmesser
Cheese slicing knife · Faca para cortar queijo

| | Ref | € | cm | U.Venta |
|--|-------|-------|----|---------|
| | 39101 | 42,60 | 40 | 1 |

Tijeras

INOX  Dishwasher



Tijeras para aves Black

Ciseaux à volaille · Geflügelschere
Poultry shears · Tesouras para aves

| | Ref | € | cm | U.Venta |
|--|-------|-------|--------|---------|
| | 60001 | 19,30 | 7,5x27 | 12 |

Protector y cepillo de limpieza

Protector and cleaning brush



Tijeras 5 cortes

Ciseaux 5 coupe · 5-fach Schneideschere
5 Cuts vegetable scissor · Tesouras 5 cortes

| | Ref | € | cm | U.Venta |
|--|-------|------|---------|---------|
| | 60022 | 8,70 | 27x13x3 | 6 |

- 1.- Tijeras · Scissors
- 2.- Abrebotellas · Unscrew
- 3.- Cascanueces · Nut cracker

1

2

3



Tijeras profesionales Inox

Ciseaux profesional · Geflügelschere Profesional
Professional scissors · Tesouras professional

| | Ref | € | cm | U.Venta |
|--|-------|-------|--------|---------|
| | 38010 | 22,40 | 7,0x20 | 12 |

Tijera desescamador

Ciseaux ecailleur · Schere-Fischentschupper
Scissors-scrapper · Tesoura-raspador

| | Ref | € | Largo (cm) | U.Venta |
|--|-------|------|------------|---------|
| | 60061 | 6,10 | 23 | 1 |

Ambidiestro
Ambidextrous



FO
Forjado
Wought

Tijeras para aves Inox

Ciseaux à volaille · Geflügelschere
Poultry shears · Tesouras para aves

| | Ref | € | Largo (cm) | U.Venta |
|--|-------|-------|------------|---------|
| | 60066 | 36,20 | 25 | 1 |

Soporte magnético

Magnetic holder



Tijeras de cocina Magnetic

Ciseaux pour cuisine · Küchenschere
Kitchen shears · Tesouras de cozinha

| | Ref | € | Largo (cm) | U.Venta |
|--|-------|-------|------------|---------|
| | 60059 | 10,30 | 21,5 | 6 |



Tijera de cocina Grey

Ciseaux pour cuisine · Küchenschere
Kitchen shears · Tesouras de cozinha

| | Ref | € | cm | U.Venta |
|--|-------|-------|--------|---------|
| | 60018 | 11,00 | 8,5x21 | 1 |
| | 60023 | 11,10 | 8,5x24 | 1 |

Abrelatas



Dishwasher



Altura máx. de lata: 30 cm - Maxime height of caniste: 30 cm

Abrelatas de mesa profesional

Ouvre-boîte de table professionnel · Profe-Dosenöffner für Tisch
Professional table tin opener · Abre-latas de mesa profesional

| Ref | € | U.Venta |
|-------|--------|---------|
| 63005 | 131,70 | 1 |
| 63015 | 194,20 | 1 |



Abrelatas

Ouvre-boîte · Dosenöffner
Can opener · Abre-latas

| Ref | € | cm | Largo (cm) | U.Venta |
|-------|-------|-----|------------|---------|
| 62689 | 27,20 | 5x4 | 20 | 6 |

Tacos para cuchillos



Dishwasher



BPA free

- Bloques cilíndricos fabricados en polipropileno con recubrimiento TPR y acabado en color blanco mate (39037) / metalizado (39038).
- Diseñados para almacenar cuchillos de filo liso, filo dentado y tijeras.
- Aptos para cuchillos de hasta 20 cm (39037) / 21 cm (39038) de longitud de hoja.
- Varillas interiores de fibras de polipropileno (39037).
- Las ranuras separan los bordes de los filos sin tocarse ni rayarse entre sí (39038).
- Desmontables para facilitar la limpieza.

- Bloc cylindrique fabriqué en polypropylène avec un revêtement TPR et une finition blanc mat (39037) / métallisé (39038).
- Conçu pour ranger des couteaux à fil lisse, à fil denté et des ciseaux.
- Compatibles avec des couteaux jusqu'à 20 cm (39037) / 21 cm (39038) de longueur de lame.
- Tiges intérieures en fibre de polypropylène (39037).
- Les rainures séparent les bords des fils, évitant ainsi qu'il se touchent ou se rayent entre eux (39038).
- Démontables pour faciliter le nettoyage.

- Cylindrical polypropylene knife holder with TPR coating and matte white finish (39037) / metallised (39038).
- Designed to hold smooth-edged knives, serrated knives and scissors.
- Suitable for knives with blade lengths up to 20 cm (39037) / 21 cm (39038).
- Inner polypropylene fibre rods. (39037).
- The slots separate the edges of the blades and prevent them from touching or scratching each other (39038).
- Removable for easy cleaning.



Varillas de fibras
Fibre rods



Tacos de cuchillos White

Bloc à couteaux · Messerblock
Knife block · Taco para facas

| Ref | € | Ø (cm) | h (cm) | U.Venta |
|-------|-------|--------|--------|---------|
| 39037 | 14,90 | 11 | 22,0 | 1 |



Ranuras separadoras
Slots separators



Tacos para cuchillos TitanPro

Bloc à couteaux · Messerblock
Knife block · Taco para facas

| Ref | € | Ø (cm) | h (cm) | U.Venta |
|-------|-------|--------|--------|---------|
| 39038 | 14,00 | 13 | 22,8 | 1 |

Soporte para cuchillos



Dishwasher



- Potente imán en el interior para sujetar con seguridad los cuchillos, tijeras y otros artículos metálicos.
- Incluye un set de montaje para instalar el soporte de cuchillos sobre cualquier tipo de pared.

- Aimant puissant à l'intérieur pour tenir des couteaux, des ciseaux et d'autres objets métalliques en toute sécurité.
- Comprend un ensemble de montage pour installer la prise en charge des couteaux sur tout type de mur.

- Powerful magnet inside to safely hold knives, scissors and other metal items.
- Includes a mounting set to install knives support on any type of wall.



RUBBER
WOOD

Soporte magnético cuchillos Wood

Support magnétique pour couteaux · Magnethalterung für Messer
Magnet support for knives · Suporte magnético de facas

| Ref | € | cm | h (cm) | Útil (cm) | U.Venta |
|-------|-------|----|--------|-----------|---------|
| 39108 | 27,80 | 36 | 6 | 33 | 1 |
| 39109 | 32,60 | 45 | 6 | 45 | 1 |

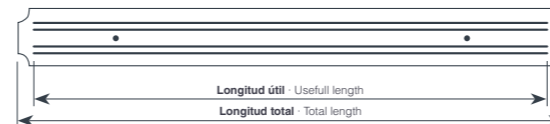

Potente imán
Powerful magnet



Dishwasher

Soporte magnético cuchillos Black

Support magnétique pour couteaux · Magnethalterung für Messer
Magnet support for knives · Suporte magnético de facas

| Ref | € | cm | Útil (cm) | U.Venta |
|-------|-------|----|-----------|---------|
| 39008 | 9,10 | 38 | 35,0 | 12 |
| 39009 | 11,10 | 55 | 52,3 | 12 |



Potente imán
Powerful magnet

HAYA
Wood



5
pcs



Bloque magnético Magnet

Bloc magnétique · Magnetblock
Magnetic block · Bloco magnético

| Ref | € | cm | U.Venta |
|-------|-------|---------|---------|
| 39039 | 27,60 | 21x22,5 | 1 |

- Bloque de madera de haya 100% natural con un potente imán integrado.
- Ideal para colocar cuchillos, tijeras o utensilios metálicos.
- Espacio para 5 cuchillos de cocina de diferentes tamaños.
- Diseño 100% estable: bloque firme y sólido.
- Ideal para mantener en buen estado los filos de los cuchillos y tenerlos siempre a mano.

- Support en hêtre 100% naturel avec un puissant aimant intégré.
- Idéal pour ranger les couteaux, les ciseaux ou les ustensiles métalliques.
- Espace pour 5 couteaux de cuisine de différentes tailles.
- Conception 100% stable : bloc fixe et solide.
- Idéal pour conserver en bon état les fils des couteaux et les avoir toujours à portée de main.

- 100% natural beech wood block with a powerful built-in magnet
- Ideal for holding knives, scissors or metal utensils.
- Space for up to 5 kitchen knives of different sizes.
- 100% Stable Design: the block is solid and sturdy.
- It's perfect for having the knives always handy and keeping their blades in good condition.

Afiladores cuchillos



Dishwasher

- **Dos fases de afilado: primera fase para un afilado grueso, para cuchillos más deteriorados. Segunda fase para el pulido final o afilado diario.**
- **Ángulo de afilado regulable: garantiza un filo renovado y efectivo.**
- **100% preciso y seguro. Base antideslizante.**

- Two sharpening phases: first phase for coarse sharpening of blunt blades. Second phase for final honing or daily sharpening.
- Adjustable sharpening angle: guarantees a renewed, much sharper edge.
- 100% precise and safe. Non-slip base.



Primera fase
Afilado grueso
First phase
Coarse sharpening



Segunda fase
Pulido final o afilado diario
Second phase
Final honing or daily sharpening



Afilador de cuchillos vertical

Affûteuse de couteaux · Schärmaschine
Knives sharpener · Afiador de facas

| Ref | € | cm | h(cm) | U.Venta |
|-------|-------|---------|-------|---------|
| 39263 | 10,90 | 9,5x5,5 | 9,5 | 1 |

- **Afila cuchillos de filo liso.**
- **2 zonas de afilado: afilado estándar y afilado alta precisión.**
- **Cada zona consta de: 2 discos de acero de carburo duro (grueso) para vaciar bordes y 2 discos de cerámica fina para terminar el borde.**

- Shark smooth edge knives.
- 2 Sharpening areas: Standard and sharp sharpening high precision.
- Each area consists of: 2 hard carbide (thick) steel discs to empty edges and 2 fine ceramic discs to finish the edge.



Base antideslizante
Non-slip base



Orientación de afilado
Sharpening orientation



Afilador de cuchillos Dual

Affûteuse de couteaux · Schärmaschine
Knives sharpener · Afiador de facas

| Ref | € | cm | U.Venta |
|-------|-------|------------|---------|
| 39266 | 19,20 | 21,5x4,5x9 | 1 |

- **Dos ranuras de afilado:**
1.- **Ranura de carburo de tungsteno: afilado grueso para las hojas más deterioradas.**
2.- **Ranura cerámica: pulido final o afilado diario.**
- **Dos posiciones de afilado:**
1.- **Posición en superficie plana: para cuchillos pequeños con hojas rectas.**
2.- **Posición en borde o esquina: para cuchillos grandes o con hojas curvadas.**
- **Afilado óptimo en pocas pasadas.**

- 2 sharpening slots:
1.- tungsten carbide slot: coarse sharpening of blunt blades.
2.- Ceramic slot: final honing or daily sharpening.
- 2 sharpening positions:
1.- Position on flat surface: for small knives with straight blades.
2.- Edge or corner position: for knives large or curved blades.
- Optimum sharpening in just a few strokes.

Afilador de cuchillos Mini

Affûteuse de couteaux · Schärmaschine
Knives sharpener · Afiador de facas

| Ref | € | cm | h(cm) | U.Venta |
|-------|------|--------|-------|---------|
| 39264 | 7,60 | 10x5,2 | 4,5 | 1 |



- **Afilador de precisión, diseñado para alargar la vida útil de los cuchillos y tijeras.**
- **Versátil: 6 modos de afilado: afilado grueso, medio, fino, tijeras, cuchillos para sushi y cuchillos de pan.**
- **Fácil de usar: gire la perilla a la posición adecuada para el tipo de cuchillo a afilar.**
- **Ranura de afilado de carburo de tungsteno y cerámica, remodela el ángulo, afila uniformemente y rejuvenece el filo para una mejor calidad y durabilidad.**
- **Mango ergonómico y base antideslizante para mayor estabilidad y seguridad.**
- **Resistente y duradero. Ambidiestro.**

- High precision sharpener, specially designed to extend the life of knives and scissors.
- Fully versatile with 6 sharpening modes: coarse, medium, fine, scissors, sushi knives and bread knives.
- Easy to use: turn the knob to the appropriate position for the type of knife to be sharpened.
- Tungsten carbide and ceramic sharpening groove that reshapes, evenly sharpens and renews the cutting edge for better quality and longer life.
- Ergonomic handle and non-slip base for stability and safety.
- Robust and durable. Ambidextrous.



ABS
Plastic

CE
Ceramic

Carburo
Tungsten
carbide



Afilador de precisión 6 en 1

Affûteuse de précision · Präzisionsschärfer
Precision sharpener · Afiador de precisão

| Ref | € | cm | U.Venta |
|-------|-------|-------------|---------|
| 39262 | 12,90 | 8,5x4,3x9,4 | 1 |



Afilador de cuchillos Eléctrico Rond

Affûteuse de couteaux électrique · Elektrische Schärmaschine
Electric knife sharpener · Afiador de facas electrónico

| Ref | € | W | Medidas | U.Venta |
|-------|-------|----|-----------------|---------|
| 69141 | 33,00 | 60 | 14 x 14 x 10 cm | 1 |



Fase 1: Alta abrasividad · high abrasiveness
Fase 2: Afilado fino · thin sharp
Fase 3: Microafilado · micro-sharp



Afilador de cuchillos eléctrico Pro

Affûteuse de couteaux électrique · Elektrische Schärmaschine
Electric knife sharpener · Afiador de facas electrónico

| Ref | € | W | Medidas | U.Venta |
|-------|--------|-----|-----------------|---------|
| 69261 | 127,60 | 180 | 32 x 12 x 11 cm | 1 |



Cuchillos lisos · Smooth knives
Rejilla salida viruta · Chip outlet grid



Afilador de cuchillos eléctrico Mouse

Affûteuse de couteaux électrique · Elektrische Schärmaschine
Electric knife sharpener · Afiador de facas electrónico

| Ref | € | W | Medidas | U.Venta |
|-------|-------|-----|----------------|---------|
| 60359 | 50,40 | 180 | 16 x 10 x 7 cm | 1 |

- **Dispone de diferentes ranuras para poder afilar distintos tipos de utensilios como cuchillos, tijeras o destornilladores de punta plana.**
- **El motor gira a la velocidad óptima para que el afilado de los utensilios sea preciso y duradero.**
- **100% seguro: en su base se incluyen cuatro ventosas de fijación para evitar que el afilador se mueva durante su uso.**

- It has different grooves to be able to sharpen different types of utensils such as knives, scissors or screwdrivers on the flat tip.
- The engine revolves at the optimal speed so that the sharpening of the utensils is precise and lasting.
- 100% safe: four fixing suction cups are included to prevent the sharpener from moving during use.



Afilador de cuchillos eléctrico TitanPro

Affûteuse de couteaux électrique · Elektrische Schärmaschine
Electric knife sharpener · Afiador de facas electrónico

| Ref | € | W | Medidas | U.Venta |
|-------|-------|----|------------|---------|
| 69341 | 40,20 | 60 | 17x8x10 cm | 1 |

- **Afilador de cuchillos eléctrico fabricado con discos de material resistente y preparados para el uso intensivo.**
- **Diseñado para afilar cuchillos de acero inoxidable (lisos y dentados) y cuchillos de cerámica. Ángulo de afilado de 20°.**
- **Sistema basado en 3 etapas: grueso, fino y pulido.**
- **Eficiente y potente: equipado con un motor de 18 W de corriente continua y una rotación de alta velocidad de 2800 r.p.m.**
- **Rodillo con recubrimiento 100% de diamante en ranura gruesa (grano 360), abrasivos de diamante en ranura fina (grano 600) y resina de alta tecnología en ranura de pulido (grano 1000). Afilado rápido y seguro.**
- **Base magnética que recoge las partículas de material metálico desbastado.**
- **Base antideslizante: garantiza la estabilidad durante el uso.**

- Electric knife sharpener fitted with hard-wearing discs of resistant material and designed for heavy-duty use.
- Designed for sharpening stainless steel (smooth and serrated) and ceramic knives. 20-degree sharpening angle.
- 3-stage sharpening system: coarse, fine and polish.
- Efficient and powerful: equipped with an 18 W DC, 2800 RPM high speed motor.
- Roller with 100% diamond coating in the coarse slot (360 grit), diamond abrasives in the fine slot (600 grit) and high-tech resin in the polishing slot (1000 grit). Quick, safe sharpening.
- Magnetic base to collect metal shavings after the sharpening process.
- Non-slip base for optimum stability during use.



Afilador de cuchillos Drei

Affûteuse de couteaux · Schärmaschine
Knife sharpener · Afiador de facas

| Ref | € | cm | h(cm) | W | Velocidad (r.p.m.) | U.Venta |
|-------|--------|-----------|-------|----|--------------------|---------|
| 69432 | 102,60 | 26,5x10,7 | 9,5 | 18 | 2800 | 1 |

Tablas de corte



- Duradera, resistente, indeformable y antibacteriana.
- Las fibras de madera ayudan a mantener el filo de los cuchillos afilados durante más tiempo..
- GRIPsystem: pies singulares fabricados en silicona para utilizar las tablas en cualquier superficie sin riesgo de deslizamiento.
- El orificio es perfecto para colgar la tabla y facilitar su almacenaje. .

- Durable, résistant, indéformable et antibactérien.
- Les fibres en bois aident à garder le bord des couteaux tranchants plus longtemps.
- GripSystem: pieds singuliers en silicone pour utiliser les tables sur n'importe quelle surface sans risque de glissement.
- Le trou est parfait pour accrocher la table et faciliter son stockage.

- Durable, resistant, undeformable and antibacterial.
- Wooden fibers help keep the edge of sharp knives for a longer time.
- GripSystem: Singular feet made of silicone to use the tables on any surface without sliding risk.
- The hole is perfect for hanging the table and facilitating its storage.



Tabla de corte Black

Planche à découper · Schneidebrett
Cutting board · Tábua de corte

| Ref | € | cm | e (mm) | U.Venta |
|-------|-------|---------|--------|---------|
| 60580 | 18,70 | 30x21,5 | 6 | 1 |
| 60581 | 25,20 | 37x27,5 | 6 | 1 |
| 60582 | 35,70 | 44x32,5 | 6 | 1 |



Tabla de corte Nogal

Planche à découper · Schneidebrett
Cutting board · Tábua de corte

| Ref | € | cm | e (mm) | U.Venta |
|-------|-------|-----------|--------|---------|
| 60586 | 17,20 | 26,5x19,5 | 6 | 1 |
| 60587 | 21,70 | 30x23,5 | 6 | 1 |
| 60588 | 33,80 | 40x30 | 6 | 1 |



Tabla de corte para pan GN 1/1

Planche à découper pain · Schneidebrett brot
Bread cutting board · Tábua de corte pão

| Ref | € | cm | h(cm) | U.Venta |
|-------|-------|---------|-------|---------|
| 60486 | 42,00 | 53x32,5 | 2 | 1 |

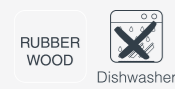

Tabla de corte para pan

Planche à découper pain · Schneidebrett brot
Bread cutting board · Tábua de corte pão

| Ref | € | cm | h(cm) | U.Venta |
|-------|-------|-------|-------|---------|
| 60487 | 29,50 | 40x30 | 2 | 1 |



Tabla de corte pan Oval

Planche à découper pain ovale · Schneidebrett oval brot
Oval bread cutting board · Tábua de corte pão oval

| Ref | € | cm | h(cm) | U.Venta |
|-------|-------|-------|-------|---------|
| 60491 | 36,80 | 40x27 | 3 | 1 |

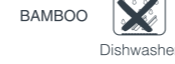

Set 3 tablas de corte

Set 3 planches à découper · Set 3 Schneidebrett
3 cutting boards set · Conjunto 3 tábuas de corte

| Ref | € | cm | U.Venta |
|-------|-------|-------|---------|
| 60523 | 18,30 | 20x15 | 1 |
| | | 28x22 | |
| | | 33x25 | |



Tabla de corte Rubber Wood

Planche à découper · Schneidebrett
Cutting board · Tábua de corte

| Ref | € | cm | h(cm) | U.Venta |
|-------|-------|-----------|-------|---------|
| 60485 | 70,30 | 53,3x32,8 | 4 | 1 |
| 60488 | 36,00 | 33x25 | 4 | 1 |



Tabla de corte Collect GN 2/3

Planche à découper · Schneidebrett
Cutting board · Tábua de corte

| Ref | € | Tabla (cm) | Cubeta | L | U.Venta |
|----------|-------|------------|-------------|------|---------|
| 60592 | 72,90 | 41,5x34x7 | - | - | 1 |
| * 66540Z | 20,50 | - | 35,4x32,5x4 | 3,50 | 1 |

* Apta cubeta inox 18/10 (66540) · Suitable for 18/10 stainless steel tray (66540)



Tabla de corte Line

Planche à découper pain · Schneidebrett brot
Bread cutting board · Tábua de corte pão

| Ref | € | cm | h(cm) | U.Venta |
|-------|-------|-------|-------|---------|
| 60495 | 23,20 | 50x15 | 2 | 1 |



Tabla de corte Dual

Planche à découper · Schneidebrett
Cutting board · Tábua de corte

| Ref | € | cm | h(cm) | U.Venta |
|-------|-------|---------|-------|---------|
| 60492 | 37,60 | 39,5x38 | 4 | 1 |



Tabla de corte Collect Home

Planche à découper · Schneidebrett
Cutting board · Tábua de corte

| Ref | € | Tabla (cm) | Cubeta | U.Venta |
|---------|-------|------------|-----------|---------|
| 60594 | 30,60 | 35x29x4 | - | 1 |
| R60594A | 4,90 | - | 34x26,5x2 | 1 |



Tabla de corte Collect 2xGN 1/2

Planche à découper · Schneidebrett
Cutting board · Tábua de corte

| Ref | € | Tabla (cm) | Cubeta | L | U.Venta |
|----------|--------|------------|-------------|------|---------|
| 60591 | 102,20 | 61,5x34x7 | - | - | 1 |
| * 66240Z | 10,90 | - | 26,5x32,5x4 | 2,50 | 1 |

* Apta cubeta inox 18/10 (66240) · Suitable for 18/10 stainless steel tray (66240)



BAMBOO
Dishwasher

Tabla de corte Collect
Planche à découper · Schneidebrett
Cutting board · Tábua de corte

| Ref | € | cm | h(cm) | U.Venta |
|-------|-------|-------|-------|---------|
| 60595 | 31,10 | 40x26 | 5 | 1 |

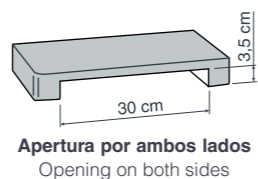

Apertura por ambos lados
Opening on both sides

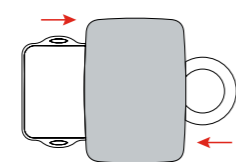

Ideal para colocar platos o bandejas en ambos lados
Ideal for placing plates or trays on both sides

- Práctica tabla de corte con una cubeta de PP oculta completamente extraíble.
- Tabla de corte tratada con un revestimiento protector y antibacteriana.
- Cubeta extraíble para recoger los alimentos cortados.
- Pies antideslizantes; garantizan la estabilidad de la tabla durante el corte.

- Practical cutting table with a completely removable hidden PP bucket.
- Treated cutting table with a protective and antibacterial coating.
- Removable bucket to collect cut foods.
- Non -slip feet; They guarantee the stability of the table during cutting.



ACACIA
Wood
CRISTAL
Glass
Dishwasher



AS
Plastic
BPA free

Set cuchillos para queso

Jeu de couteaux pour le fromage · Set von Messern für Käse
Knives set · Jogo de facas para queijo

| Ref | € | Ø (cm) | h(cm) | U.Venta |
|-------|-------|--------|-------|---------|
| 60072 | 48,30 | 25 | 5 | 1 |



- Fabricadas en polipropileno de alta densidad y máxima resistencia.
- Superficie de corte de doble cara. Tres colores diferentes. Higiénicas y fáciles de limpiar.
- Práctico agujero para colgar y facilitar el almacenaje.
- Aptas para el lavavajillas.

- Manufactured in high density and maximum resistance polypropylene.
- Double -sided cutting surface. Three different colors. Hygienic and easy to clean.
- Practical hole to hang and facilitate storage.
- Suitable for dishwasher.



PP
Polypropylene
BPA free
Dishwasher

Set de tablas de corte Grey
Set 3 planches à découper · Set 3 Schneiderbrett
3 cutting boards set · Conjunto 3 tábuas de corte

| Ref | € | cm | U.Venta |
|-------|-------|-------|---------|
| 60500 | 13,60 | 20x15 | 1 |
| | | 30x20 | |
| | | 35x25 | |



PP
Polypropylene
BPA free
Dishwasher

Set de tablas de corte Ocean
Set 3 planches à découper · Set 3 Schneiderbrett
3 cutting boards set · Conjunto 3 tábuas de corte

| Ref | € | cm | U.Venta |
|-------|-------|-------|---------|
| 60555 | 13,60 | 20x15 | 1 |
| | | 30x20 | |
| | | 35x25 | |

Asa para facilitar su manejo
Tope de silicona antideslizante
Antibacteriana
Handle for easy handling
Non-slip silicone stopper
Antibacterial

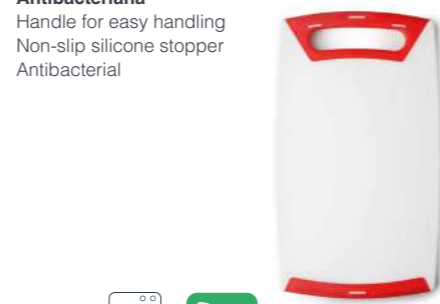

PP
Polypropylene
Dishwasher
BPA free

Tabla de corte Red
Planche à découper · Schneidebrett
utting board · Tábua de corte

| Ref | € | cm | h(cm) | U.Venta |
|-------|-------|---------|-------|---------|
| 60501 | 8,30 | 30x18 | 1 | 1 |
| 60502 | 11,40 | 36x22 | 1 | 1 |
| 60503 | 15,30 | 42x25,5 | 1 | 1 |

Tacos antideslizantes
Non slip plugs



PE
Polyethylene
Dishwasher
BPA free

Tabla de corte polietileno

Planche à découper en polyéthylène · Schneidebrett Polyethylen
Polyethylene cutting board · Tábua de corte polietileno

| Ref | € | h(cm) | U.Venta | |
|-------|--------|-------|---------|---------------------|
| 60569 | 11,10 | 2,0 | 6 | GN 1/4 · 265x162 mm |
| 60455 | 21,70 | 2,0 | 6 | GN 1/2 · 325x265 mm |
| 60405 | 31,90 | 3,0 | 6 | |
| 60456 | 42,90 | 2,0 | 1 | GN 1/1 · 530x325 mm |
| 60406 | 64,00 | 3,0 | 1 | |
| 60575 | 124,20 | 5,0 | 1 | |
| 60457 | 60,50 | 2,0 | 1 | 600x400 mm |
| 60407 | 89,60 | 3,0 | 1 | |

Tacos antideslizantes
Non slip plugs



PE
Polyethylene
Dishwasher
BPA free

Tabla de corte antialérgica

Planche à découper · Schneidebrett
Anti-allergy cutting board · Tábua de corte

| Ref | € | Medidas | h(cm) | U.Venta | |
|-------|-------|------------|-------|---------|---------------------|
| 60521 | 24,70 | 325x265 mm | 20 | 1 | GN 1/2 · 325x265 mm |
| 60522 | 49,30 | 530x325 mm | 20 | 1 | GN 1/1 · 530x325 mm |
| 60606 | 60,30 | 600x400 mm | 20 | 1 | 600x400 mm |

- Diseñado para organizar hasta 6 tablas de corte de 3 cm de espesor.
- Multifuncional: apto para tablas, bandejas, moldes rígidos, etc.

- Designed to hold up to six 3 cm-thick cutting boards.
- Multifunctional: suitable for boards, trays, rigid moulds, etc.



Pescado · Fish
Verduras+frutas · Vegetables+Fruits
Embutidos · Cold cred meat
Carne · Meat
Aves · Poultry
Varios · Various

Tabla de corte

Planche à découper · Schneidebrett
Cutting board · Tábua de corte

| GN 1/4 · 265x162 mm | | | | GN 1/2 · 325x265 mm | | | | GN 1/1 · 530x325 mm | | | | 600X400 mm | | | |
|---------------------|-------|-------|---------|---------------------|-------|-------|---------|---------------------|--------|-------|---------|------------|-------|-------|---------|
| Ref | € | h(cm) | U.Venta | Ref | € | h(cm) | U.Venta | Ref | € | h(cm) | U.Venta | Ref | € | h(cm) | U.Venta |
| 60570 | 11,10 | 2,0 | 1 | 60470 | 21,70 | 2,0 | 1 | 60475 | 42,70 | 2,0 | 1 | 60600 | 60,80 | 2,0 | 1 |
| 60571 | 11,10 | 2,0 | 1 | 60471 | 21,70 | 2,0 | 1 | 60476 | 42,70 | 2,0 | 1 | 60601 | 60,80 | 2,0 | 1 |
| 60572 | 11,10 | 2,0 | 1 | 60472 | 21,70 | 2,0 | 1 | 60477 | 42,70 | 2,0 | 1 | 60602 | 60,80 | 2,0 | 1 |
| 60573 | 11,10 | 2,0 | 1 | 60473 | 21,70 | 2,0 | 1 | 60478 | 42,70 | 2,0 | 1 | 60603 | 60,80 | 2,0 | 1 |
| - | - | - | - | - | - | - | - | 60576 | 121,00 | 5,0 | 1 | - | - | - | - |
| 60574 | 11,10 | 2,0 | 1 | 60474 | 21,70 | 2,0 | 1 | 60479 | 42,70 | 2,0 | 1 | 60604 | 60,80 | 2,0 | 1 |
| 60577 | 11,10 | 2,0 | 1 | 60480 | 21,70 | 2,0 | 1 | 60481 | 42,70 | 2,0 | 1 | 60605 | 60,80 | 2,0 | 1 |

PE-500 (HD-HMW) High Molecular AA Weight Polyethylene

PE
Polyethylene
Dishwasher
BPA free

Cepillo para tablas de corte

Brosse pour planche à découper · Brush für Schneidebrett
Brush cutting board · Cepilho para tábuas de corte

| Ref | € | cm | h(cm) | U.Venta |
|-------|-------|------|-------|---------|
| 60458 | 68,10 | 17x6 | 10 | 1 |



Soporte tablas de corte

Support pour planches à découper · Schneidbretthalter
Cutting board rack · Suporte para tábuas de cortar

| Ref | € | cm | h(cm) | U.Venta |
|-------|-------|-------|-------|---------|
| 60579 | 28,70 | 34x30 | 27,8 | 1 |

Cubiertos

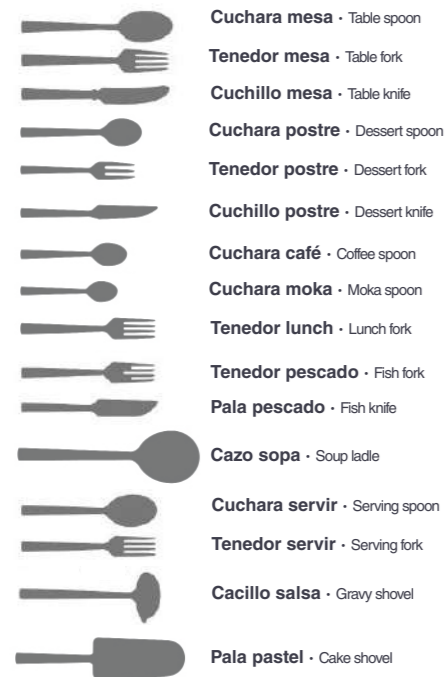

Cuchara mesa · Table spoon
Tenedor mesa · Table fork
Cuchillo mesa · Table knife
Cuchara postre · Dessert spoon
Tenedor postre · Dessert fork
Cuchillo postre · Dessert knife
Cuchara café · Coffee spoon
Cuchara moka · Moka spoon
Tenedor lunch · Lunch fork
Tenedor pescado · Fish fork
Pala pescado · Fish knife
Cazo sopa · Soup ladle
Cuchara servir · Serving spoon
Tenedor servir · Serving fork
Cacillo salsa · Gravy shovel
Pala pastel · Cake shovel

INOX

Hotel

| Ref | € | U.Venta |
|-------|------|---------|
| 33101 | 1,80 | 12 |
| 33102 | 1,80 | 12 |
| 33103 | 2,90 | 12 |
| 33104 | 1,40 | 12 |
| 33105 | 1,40 | 12 |
| 33106 | 2,80 | 12 |
| 33107 | 1,10 | 12 |
| 33108 | 0,90 | 12 |
| 33109 | 1,10 | 12 |

INOX 18/10

Aries

| Ref | € | U.Venta |
|-------|-------|---------|
| 33401 | 2,80 | 12 |
| 33402 | 2,80 | 12 |
| 33403 | 6,20 | 12 |
| 33404 | 2,80 | 12 |
| 33405 | 2,80 | 12 |
| 33406 | 6,20 | 12 |
| 33407 | 1,40 | 12 |
| 33408 | 1,30 | 12 |
| 33409 | 1,80 | 12 |
| 33410 | 2,80 | 12 |
| 33411 | 2,80 | 12 |
| 33412 | 10,90 | 1 |
| 33413 | 6,70 | 1 |
| 33414 | 6,80 | 1 |
| 33415 | 8,60 | 1 |
| 33416 | 7,40 | 1 |

Cuberteros

- Solución ideal para almacenar, guardar y conservar los cubiertos de forma organizada.
- 5 compartimentos individuales apilados para diferentes tipos de cubiertos.
- Iconos en cada compartimento para identificarlos fácilmente.
- Diseñado para cajones con una altura mínima de 8 cm.

- Ideal solution for storing, keeping and preserving cutlery in a well-organised way.
- 5 individual stackable compartments for different types of cutlery.
- Easily recognisable icons on each compartment for clear identification.
- Suitable for drawers with a minimum height of 8 cm.

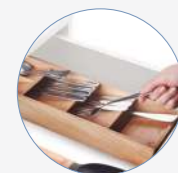

HAYA
Wood

Organizador de Cubiertos Compact
 Range-couverts · Besteckkasten
 Cutlery Organiser · Organizador de talheres

| Ref | € | cm | h(cm) | U.Venta |
|-------|-------|-----------|-------|---------|
| 39050 | 27,40 | 39,5x12,2 | 6,0 | 1 |

- Solución ideal para almacenar, guardar y conservar los cuchillos de forma segura y organizada.
- Diseñado para almacenar hasta 8 cuchillos con hojas de hasta 25 cm para cajones con una altura mín. de 8,5 cm.
- Diseño de dos niveles:

- Ideal solution for storing, keeping and preserving knives in a safe and well organised way.
- Designed to store up to 8 knives with blades of up to 25 cm, and for drawers with a minimum 8.5 cm height.
- Two-tier design:



HAYA
Wood

Organizador de Cuchillos Compact
 Organisateur de couteaux · Messerhalter
 Knife organiser · Organizador de facas

| Ref | € | cm | h(cm) | U.Venta |
|-------|-------|---------|-------|---------|
| 39049 | 24,40 | 40,5x11 | 4,5 | 1 |



INOX Dishwasher

Soporte para cubiertos con vasos

Porte couverts avec paniers · Besteckbehälter
 Cutlery holder w/cylinder · Sup. talheres com copos

| Ref | € | cm | Orificios | U.Venta |
|-------|--------|----------|-----------|---------|
| 33124 | 87,00 | 29x22x26 | 4 | 1 |
| 33126 | 106,90 | 29x22x38 | 6 | 1 |



INOX Dishwasher

Vaso inox cubertería

Panier pour porte couvert · Besteckköcher
 St. steel cutlery cylinder · Copos p/talheres inox

| Ref | € | h(cm) | U.Venta |
|-------|------|-------|---------|
| 33125 | 7,80 | 14 | 6 |

- Ideal para organizar y guardar los cubiertos y utensilios de la cocina.
- No se deforma con el peso de los cubiertos.
- Cómodo de transportar gracias a sus asas laterales.
- Apilable.

- Ideal to organize and save the cutlery and kitchen utensils.
- It does not deform with the weight of the cutlery.
- Comfortable to transport thanks to your lateral handles.
- Stackable.



INOX Dishwasher
 PP Polypropylene
 BPA free

Cubertero GN 1/1

Range-couverts · Besteckkasten
 Cutlery holder · Bandeja para talheres

| Ref | € | cm | h(cm) | U.Venta |
|-------|-------|---------|-------|---------|
| 33121 | 11,50 | 52,5x32 | 9,5 | 1 |

Contenedor cubiertos

Panier à couverts · Besteckköcher
 Cutlery holder · Copos para talheres

| Ref | € | Ø (cm) | h(cm) | L | U.Venta |
|-------|-------|--------|-------|------|---------|
| 62962 | 21,60 | 12 | 13,6 | 1,40 | 1 |
| 62963 | 25,10 | 12 | 18,7 | 2,00 | 1 |

- Recipiente para cubiertos en color negro de polipropileno.
- Ideal para organizar y guardar los cubiertos y utensilios de la cocina.
- Apilable.

- Récipient de couverts en polypropylène noir.
- Idéal pour organiser et sauver les couverts et les ustensiles de cuisine.
- Empilable.

- Black polypropylene cutlery container.
- Ideal to organize and save the cutlery and kitchen utensils.
- Stackable.

PP Polypropylene
 BPA free

Cubertero Ratán

Range-couverts · Besteckkasten
 Cutlery holder · Bandeja para talheres

| Ref | € | cm | h(cm) | Compartimentos | U.Venta |
|---------|-------|---------|-------|----------------|---------|
| A 63484 | 8,60 | 27x10 | 4,5 | 1 | 1 |
| B 63485 | 8,60 | Ø12 | 15,0 | 1 | 1 |
| C 63491 | 76,80 | 53x32,5 | 9,0 | 4 | 1 |



03

Mesa
Table Top

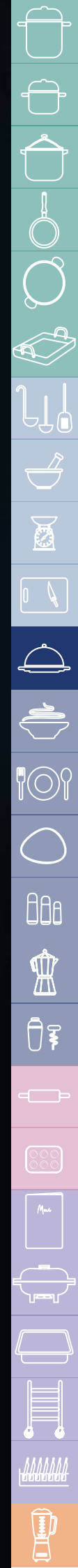

Bandejas Inox

INOX



INOX
18/10



Fuente oval

Plat ovale · Buffet-Tablett, oval
Oval dish · Travessa oval

| Ref | € | cm | U.Venta |
|-------|-------|-------|---------|
| 61820 | 6,10 | 20x13 | 1 |
| 61825 | 8,50 | 25x17 | 1 |
| 61830 | 9,30 | 30x20 | 1 |
| 61835 | 11,60 | 35x23 | 1 |
| 61840 | 14,00 | 40x26 | 1 |
| 61845 | 16,30 | 45x29 | 1 |
| 61850 | 20,00 | 50x31 | 1 |
| 61871 | 46,40 | 70x45 | 1 |
| 61881 | 54,20 | 80x48 | 1 |

Fuente oval pulido satinado

Plat ovale poli-satine · Buffet-Tablett, oval
Oval dish satin polish · Travessa oval pulido mate

| Ref | € | cm | U.Venta |
|-------|-------|-------|---------|
| 62820 | 8,80 | 20x13 | 1 |
| 62825 | 11,20 | 25x17 | 1 |
| 62830 | 14,00 | 30x20 | 1 |
| 62835 | 17,30 | 35x23 | 1 |
| 62840 | 22,70 | 40x26 | 1 |
| 62845 | 25,70 | 45x29 | 1 |
| 62850 | 30,90 | 50x31 | 1 |

Fuente redonda

Plat rond · Bratenplatte, rund
Round serving dish · Travessa redonda

| Ref | € | Ø (cm) | U.Venta |
|-------|-------|--------|---------|
| 61831 | 11,30 | 30 | 6 |
| 61836 | 14,10 | 35 | 6 |

Fuente de pescado

Plat à poisson · Fischplatte
Fish tray · Travessa peixe

| Ref | € | cm | U.Venta |
|-------|-------|-------|---------|
| 61860 | 28,90 | 60x27 | 1 |
| 61880 | 36,60 | 80x30 | 1 |

Fuente honda oval

Plat à gratin ovale · Schale, oval
Deep oval dish · Travessa funda oval

| Ref | € | cm | h(cm) | U.Venta |
|-------|-------|-------|-------|---------|
| 61828 | 14,10 | 30x20 | 4,5 | 1 |
| 61832 | 17,20 | 35x24 | 4,5 | 1 |
| 61838 | 21,20 | 40x26 | 4,5 | 1 |
| 61843 | 22,80 | 45x29 | 4,5 | 1 |
| 61848 | 27,20 | 50x31 | 4,7 | 1 |

garinox®

Bandeja de marisco

Plateau a fruit de mer · Platte für seemuschel
Sea food tray · Bandeja de mariscos

| Ref | € | Ø (cm) | U.Venta |
|-------|-------|--------|---------|
| 14027 | 10,00 | 28 | 6 |
| 14042 | 22,20 | 42 | 1 |
| 14050 | 34,70 | 50 | 6 |

AL

Aluminium

Bandeja Master

Plateau · Platte
Tray · Bandeja

| Ref | € | cm | h(cm) | U.Venta |
|---------|-------|-------|-------|---------|
| A 68465 | 23,70 | 45x33 | 5,0 | 1 |
| B 68466 | 24,80 | 53x38 | 2,5 | 1 |



Soporte para bandeja de mariscos

Support pour plateau a fruit de mer · Ständer für Seemuschelplatte,
Stand for sea food tray · Suporte para bandeja de mariscos

| Ref | € | Ø (cm) | Ød (cm) | h(cm) | U.Venta |
|-------|-------|--------|---------|-------|---------|
| 14100 | 15,00 | 24,5 | 19 | 20 | 1 |



Soporte para bandejas

Support pour plateaux · Tablethalter
Tray stand · Suporte para bandejas

| Ref | € | cm | h(cm) | U.Venta |
|-------|-------|---------|-------|---------|
| 61870 | 69,90 | 41,5x52 | 80 | 1 |



INOX
18/10



Bandeja camarero

Plateau limonadier · Serviertablett, rund
Serving tray · Bandeja de servir

| Ref | € | Ø (cm) | U.Venta |
|-------|-------|--------|---------|
| 61841 | 21,60 | 40 | 1 |

Bandeja camarero pulido satinado

Plateau limonadier poli-satine · Serviertablett, rund
Serving tray satin polish · Bandeja de servir pulido mate

| Ref | € | Ø (cm) | U.Venta |
|-------|-------|--------|---------|
| 62841 | 28,70 | 40 | 1 |

Bandeja camarero Garinox

Plateau limonadier · Serviertablett
Serving tray · Bandeja de servir

| Ref | € | Ø (cm) | U.Venta |
|-------|-------|--------|---------|
| 14135 | 10,40 | 32 | 6 |
| 14136 | 12,00 | 36 | 1 |
| 14145 | 20,30 | 45 | 1 |



Plato de huevos

Plat à oeufs · Eiteller
Egg serving dish · Prato de ovos

| Ref | € | Ø (cm) | h(cm) | U.Venta |
|-------|------|--------|-------|---------|
| 61116 | 5,20 | 16 | 3 | 6 |

Posabotellas

Dessous de bouteille · Flaschenuntersetzer
Bottle stand · Pousa-garrafas

| Ref | € | Ø (cm) | U.Venta |
|-------|------|--------|---------|
| 61113 | 3,90 | 13 | 6 |

Posavasos

Sous-verre · Glasuntersetzer
Glass stand · Pousa-copos

| Ref | € | Ø (cm) | U.Venta |
|-------|------|--------|---------|
| 61110 | 3,30 | 10,5 | 6 |



INOX
18/10

PP ABS
Polypropylene Plastic

Bandeja con pinza para notas

Porte addition à pince · Platte mit Klemmvorrichtung
Bill holder · Bandeja com pinça para notas

| Ref | € | cm | U.Venta |
|---------|------|---------|---------|
| A 68007 | 5,40 | 11x15,2 | 12 |
| B 68017 | 6,40 | 12x21,5 | 12 |

Bandeja cambios Coin

Coupelle ramasse monnaie · Wechselgeldablagen
Changetray · Bandeja para trocos

| Ref | € | Ø (cm) | U.Venta |
|-------|------|--------|---------|
| 68720 | 3,20 | 13 | 12 |



Plato camping

Plate de camping · Campingplatte
Camping dinner plate · Prato camping

| Ref | € | Ø (cm) | U.Venta |
|---------|------|--------|---------|
| A 61121 | 7,20 | 22 | 1 |
| B 61122 | 7,60 | 22 | 6 |

Bandejas Fibreglass



- Para uso profesional.
- Fabricada en fibra de vidrio.
- Superficie antiadherente y antideslizante.
- Indeformable y muy ligera.

- Pour une utilisation professionnelle.
- Fabriqué en fibre de verre.
- Surface non étalée et non glissante.
- UNDEFORMABLE ET TRÈS LIGHT.

- For professional use.
- Manufactured in fiberglass.
- Non -striped and non -slip surface.
- Undeformable and very light.



Bandeja redonda

Plateau rond · Serviertablett rund
Round tray · Bandeja redonda

| Ref | € | Ø (cm) | U.Venta |
|-------|-------|--------|---------|
| 69136 | 14,50 | 36 | 1 |
| 69140 | 21,50 | 40 | 1 |

Bandeja rectangular

Plateau rectangulare · Serviertablett, rechteckig
Rectangular tray · Bandeja rectangular

| Ref | € | cm | U.Venta |
|-------|-------|-------|---------|
| 69146 | 25,20 | 36x46 | 1 |
| 69152 | 30,30 | 38x52 | 1 |
| 69156 | 38,50 | 40x56 | 6 |
| 69165 | 55,40 | 45x65 | 6 |

Bandeja Oval

Plateau ovale · Oval Serviertablett
Oval tray · Bandeja oval

| Ref | € | cm | U.Venta |
|-------|-------|-------|---------|
| 69168 | 65,90 | 56x68 | 6 |

Bandejas Pizarra



- Totalmente artesanal, cada bandeja es única e irrepetible.
- Ideal para la presentación de platos fríos y calientes.
- Ofrece un aire de modernidad, elegancia y sencillez.
- Excelente conductor del frío y del calor.
- Evita los cambios bruscos de temperatura para su conservación.
- Contiene tacos antideslizantes para asegurar su estabilidad.
- **NOTA: para conservarla brillante y con su color natural, cada ciertos usos impregnar con aceite de oliva virgen extra por ambas caras y cantos.**

- Totalement fabriqué à la main, chaque plateau est unique et incompatable.
- Idéal pour la présentation des plats froids et chauds.
- Il offre un air de modernité, d'élégance et de simplicité.
- Excellent conducteur de froid et de chaleur.
- Évitez les changements soudains de température pour la conservation.
- Il contient des tacos sans glissement pour assurer sa stabilité.
- Remarque: Pour le garder brillant et avec sa couleur naturelle, chaque utilisation certaines imprégnait de l'huile d'olive extra vierge des deux côtés et des chansons.

- Totally handmade, each tray is unique and unrepeatable.
- Ideal for the presentation of cold and hot dishes.
- It offers an air of modernity, elegance and simplicity.
- Excellent driver of cold and heat.
- Avoid sudden changes in temperature for conservation.
- It contains non -slip tacos to ensure its stability.
- Note: To keep it bright and with its natural color, every certain uses permeate with extra virgin olive oil on both sides and songs.



Bandeja redonda

Plateau rond · Serviertablett rund
Round tray · Bandeja redonda

| Ref | € | Ø (cm) | e (mm) | U.Venta |
|-------|-------|--------|--------|---------|
| 61070 | 3,60 | 20 | 5 | 6 |
| 61071 | 5,10 | 25 | 5 | 6 |
| 61072 | 7,10 | 30 | 5 | 6 |
| 61073 | 10,00 | 35 | 5 | 4 |
| 61078 | 10,10 | 40 | 5 | 4 |

Bandeja cuadrada

Plateau carré · Serviertablett, viereckig
Square tray · Bandeja quadrada

| Ref | € | cm | e (mm) | U.Venta |
|-------|-------|-------|--------|---------|
| 61010 | 3,10 | 10x10 | 5 | 32 |
| 61015 | 4,50 | 15x15 | 5 | 32 |
| 61019 | 5,20 | 20x20 | 5 | 24 |
| 61044 | 16,40 | 40x40 | 5 | 8 |

Bandeja rectangular

Plateau rectangulare · Serviertablett, rechteckig
Rectangular tray · Bandeja rectangular

| Ref | € | cm | e (mm) | U.Venta |
|-------|-------|-------|--------|---------|
| 61016 | 4,30 | 10x15 | 5 | 48 |
| 61021 | 5,00 | 15x20 | 5 | 24 |
| 61029 | 6,30 | 15x30 | 5 | 18 |
| 61031 | 7,90 | 20x30 | 5 | 12 |
| 61041 | 9,20 | 20x40 | 5 | 12 |
| 61051 | 13,00 | 20x50 | 5 | 8 |
| 61043 | 14,40 | 40x30 | 5 | 8 |
| 61064 | 29,30 | 60x40 | 5 | 3 |

Melamina
Melamine





Earth Collection

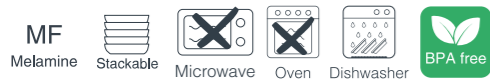

- Fabricada en melamina de alta calidad. Libre de BPA.
- Diseñada para realzar las creaciones del chef.
- Ligera, resistente a golpes y choques térmicos.
- Higiénica y fácilmente lavable. Apta para el lavavajillas.

- Fabriqué en mélamine de haute qualité. Sans BPA.
- Conçu pour améliorer les créations du chef.
- Léger, résistant aux coups et aux chocs thermiques.
- Hygénique et facilement lavable. Convient au lave-vaisselle.

- Made of high quality melamine. BPA free.
- Designed to enhance the creations of the chef.
- Light, resistant to blows and thermal shocks.
- Hygienic and easily washable. Suitable for dishwasher.



Fuente rectangular Square
Plateau rectangulaire · Serviertablet, rechteckig
Rectangular tray · Travessa rectangular

| Ref | € | cm | h(cm) | U.Venta |
|-------|------|-----------|-------|---------|
| 63830 | 8,40 | 18,6x13,5 | 2,7 | 1 |



Fuente rectangular
Plateau rectangulaire · Serviertablet, rechteckig
Rectangular tray · Travessa rectangular

| Ref | € | cm | h(cm) | U.Venta |
|-------|-------|-----------|-------|---------|
| 63831 | 10,40 | 21,7x13,6 | 3,1 | 1 |
| 63832 | 12,70 | 25,2x17,2 | 3,6 | 1 |
| 63834 | 21,40 | 30,8x21,6 | 3,5 | 1 |
| 63855 | 29,30 | 35x23,8 | 4,1 | 1 |



Fuente rectangular Long
Plateau rectangulaire · Serviertablet, rechteckig
Rectangular tray · Travessa rectangular

| Ref | € | cm | h(cm) | U.Venta |
|-------|-------|-----------|-------|---------|
| 63833 | 11,70 | 28,6x12,7 | 3,4 | 1 |



Fuente rectangular ondulada
Plateau rectang. ondulé · Serviertablet, rechteckig, gewellt
Rectangular undulated tray · Travessa rectang. ondulada

| Ref | € | cm | h(cm) | U.Venta |
|-------|-------|---------|-------|---------|
| 63865 | 18,90 | 29x17,5 | 3,0 | 1 |



Fuente Oval
Plateau oval · Oval platte
Oval tray · Travessa redonda

| Ref | € | cm | h(cm) | U.Venta |
|-------|------|---------|-------|---------|
| 63863 | 9,80 | 25,4x13 | 2,9 | 1 |



Fuente lágrima
Plateau larme · Träne platte
Tear tray · Travessa lágrima

| Ref | € | cm | h(cm) | U.Venta |
|-------|-------|---------|-------|---------|
| 63854 | 17,20 | 28,4x19 | 5,1 | 1 |



Fuente Oval alta
Plateau oval · Oval platte
Oval tray · Travessa redonda

| Ref | € | cm | h(cm) | U.Venta |
|-------|-------|-----------|-------|---------|
| 63852 | 8,60 | 19,7x14,1 | 3,7 | 1 |
| 63853 | 11,80 | 22,5x16,4 | 4,4 | 1 |
| 63864 | 18,60 | 28,2x21,4 | 4,8 | 1 |



Plato redondo
Plateau rond · Rund Teller
Round plate · Prato redondo

| Ref | € | Ø (cm) | h(cm) | U.Venta |
|-------|-------|--------|-------|---------|
| 63841 | 6,20 | 15,5 | 2,4 | 1 |
| 63842 | 9,20 | 19,4 | 2,9 | 1 |
| 63843 | 10,00 | 21,5 | 3,2 | 1 |
| 63844 | 15,70 | 24,2 | 3,5 | 1 |
| 63845 | 18,10 | 25,6 | 3,7 | 1 |



Plato hondo redondo
Platteau profonde ronde · Rund tiefe Platte
Round deep plate · Prato profundo redondo

| Ref | € | Ø (cm) | h(cm) | U.Venta |
|-------|-------|--------|-------|---------|
| 63839 | 9,20 | 17,7 | 4,4 | 1 |
| 63840 | 19,40 | 24 | 5,5 | 1 |



Fuente cuadrada
Plateau carrée · Quadratischen platte
Square tray · Travessa quadrado

| Ref | € | cm | h(cm) | U.Venta |
|-------|-------|-------|-------|---------|
| 63846 | 7,70 | 12x12 | 5,0 | 1 |
| 63847 | 16,20 | 19x19 | 6,0 | 1 |
| 63848 | 25,20 | 24x24 | 6,8 | 1 |



Bol
Bol · Boul
Bowl · Bacia

| Ref | € | Ø (cm) | h(cm) | ml | U.Venta |
|-------|------|--------|-------|-----|---------|
| 63861 | 6,60 | 12,4 | 4,6 | 300 | 1 |



Bol
Bol · Boul
Bowl · Bacia

| Ref | € | Ø (cm) | h(cm) | ml | U.Venta |
|-------|------|--------|-------|-----|---------|
| 63856 | 3,10 | 8,3 | 3,2 | 60 | 1 |
| 63857 | 4,90 | 9,5 | 4,6 | 130 | 1 |
| 63858 | 5,20 | 10,6 | 5,2 | 220 | 1 |
| 63859 | 7,20 | 12,6 | 6,0 | 300 | 1 |



Bol oval
Bol oval · Oval bowl
Oval bowl · Bacia oval

| Ref | € | cm | h(cm) | ml | U.Venta |
|-------|-------|-----------|-------|------|---------|
| 63849 | 4,60 | 12x10 | 4,1 | 130 | 1 |
| 63860 | 8,00 | 16,3x12,3 | 4,7 | 220 | 1 |
| 63850 | 16,00 | 20,7x16,8 | 8,0 | 660 | 1 |
| 63851 | 25,00 | 24,2x20,6 | 9,3 | 1150 | 1 |



Bol cónico
Conique bol · Boul Konish
Conical bowl · Bacia cónica

| Ref | € | Ø (cm) | h(cm) | ml | U.Venta |
|-------|-------|--------|-------|------|---------|
| 63835 | 9,00 | 15,5 | 6 | 330 | 1 |
| 63836 | 11,00 | 18,5 | 7 | 560 | 1 |
| 63837 | 14,50 | 21,5 | 8 | 750 | 1 |
| 63838 | 20,40 | 24,0 | 9 | 1350 | 1 |



Bol salsa mini
Bol sauce mini · Boul sauce min
Sauce bowl mini · Bacia molho mini

| Ref | € | cm | h(cm) | ml | U.Venta |
|-------|------|---------|-------|----|---------|
| 63862 | 3,00 | 7,2x7,2 | 3,0 | 30 | 1 |



Sea Collection



- Fabricada en melamina de alta calidad. Libre de BPA.
- Una completa gama que ofrece un aspecto rústico, con piezas únicas y elegantes.
- Diseñada para realzar las creaciones del chef.
- Ligera, resistente a golpes y choques térmicos.
- Higiénica y fácilmente lavable. Apta para el lavavajillas.

- Fabriqué en mélamine de haute qualité. Sans BPA.
- Une gamme complète qui offre une apparence rustique, avec des pièces uniques et élégantes.
- Conçu pour améliorer les créations du chef.
- Léger, résistant aux coups et aux chocs thermiques.
- Hygiénique et facilement lavable. Convient au lave-vaisselle.

- Made of high quality melamine. BPA free.
- A complete range that offers a rustic appearance, with unique and elegant pieces.
- Designed to enhance the creations of the chef.
- Light, resistant to blows and thermal shocks.
- Hygienic and easily washable. Suitable for dishwasher.



Fuente rectangular Square

Plateau rectangulaire · Serviertablet, rechteckig
Rectangular tray · Travessa rectangular

| Ref | € | cm | h(cm) | U.Venta |
|-------|------|-----------|-------|---------|
| 63941 | 8,40 | 18,6x13,5 | 2,7 | 1 |



Fuente rectangular

Plateau rectangulaire · Serviertablet, rechteckig
Rectangular tray · Travessa rectangular

| Ref | € | cm | h(cm) | U.Venta |
|-------|-------|-----------|-------|---------|
| 63942 | 10,40 | 21,7x13,6 | 3,1 | 1 |
| 63943 | 12,70 | 25,2x17,2 | 3,6 | 1 |
| 63945 | 21,40 | 30,8x21,6 | 3,5 | 1 |
| 63966 | 29,30 | 35x23,8 | 4,1 | 1 |



Fuente rectangular Long

Plateau rectangulaire · Serviertablet, rechteckig
Rectangular tray · Travessa rectangular

| Ref | € | cm | h(cm) | U.Venta |
|-------|-------|-----------|-------|---------|
| 63944 | 11,70 | 28,6x12,7 | 3,4 | 1 |



Fuente rectangular ondulada

Plateau rectang. ondulé · Serviertablet, rechteckig, gewellt
Rectangular undulated tray · Travessa rectang. ondulada

| Ref | € | cm | h(cm) | U.Venta |
|-------|-------|---------|-------|---------|
| 63976 | 18,90 | 29x17,5 | 3,0 | 1 |



Fuente Oval

Plateau oval · Oval platte
Oval tray · Travessa redonda

| Ref | € | cm | h(cm) | U.Venta |
|-------|------|---------|-------|---------|
| 63974 | 9,80 | 25,4x13 | 2,9 | 1 |



Fuente lágrima

Plateau larme · Träne platte
Tear tray · Travessa lágrima

| Ref | € | cm | h(cm) | U.Venta |
|-------|-------|---------|-------|---------|
| 63965 | 17,20 | 28,4x19 | 5,1 | 1 |

Fuente Oval alta

Plateau oval · Oval platte
Oval tray · Travessa redonda

| Ref | € | cm | h(cm) | U.Venta |
|-------|-------|-----------|-------|---------|
| 63963 | 8,60 | 19,7x14,1 | 3,7 | 1 |
| 63964 | 11,80 | 22,5x16,4 | 4,4 | 1 |
| 63975 | 18,60 | 28,2x21,4 | 4,8 | 1 |



Plato redondo

Plateau rond · Rund Teller
Round plate · Prato redondo

| Ref | € | Ø (cm) | h(cm) | U.Venta |
|-------|-------|--------|-------|---------|
| 63952 | 6,20 | 15,5 | 2,4 | 1 |
| 63953 | 9,20 | 19,4 | 2,9 | 1 |
| 63954 | 10,00 | 21,5 | 3,2 | 1 |
| 63955 | 15,70 | 24,2 | 3,5 | 1 |
| 63956 | 18,10 | 25,6 | 3,7 | 1 |



Plato hondo redondo

Plateau profonde ronde · Rund tiefe Platte
Round deep plate · Prato profundo redondo

| Ref | € | Ø (cm) | h(cm) | U.Venta |
|-------|-------|--------|-------|---------|
| 63950 | 9,20 | 17,7 | 4,4 | 1 |
| 63951 | 19,40 | 24 | 5,5 | 1 |



Fuente cuadrada

Plateau carrée · Quadratischen platte
Square tray · Travessa quadrado

| Ref | € | cm | h(cm) | U.Venta |
|-------|-------|-------|-------|---------|
| 63957 | 7,70 | 12x12 | 5,0 | 1 |
| 63958 | 16,20 | 19x19 | 6,0 | 1 |
| 63959 | 25,20 | 24x24 | 6,8 | 1 |

Bol

Bol · Boul
Bowl · Bacia

| Ref | € | Ø (cm) | h(cm) | ml | U.Venta |
|-------|------|--------|-------|-----|---------|
| 63972 | 6,60 | 12,4 | 4,6 | 300 | 1 |



Bol

Bol · Boul
Bowl · Bacia

| Ref | € | Ø (cm) | h(cm) | ml | U.Venta |
|-------|------|--------|-------|-----|---------|
| 63967 | 3,10 | 8,3 | 3,2 | 60 | 1 |
| 63968 | 4,90 | 9,5 | 4,6 | 130 | 1 |
| 63969 | 5,20 | 10,6 | 5,2 | 220 | 1 |
| 63970 | 7,20 | 12,6 | 6,0 | 300 | 1 |



Bol oval

Bol oval · Oval boul
Oval bowl · Bacia oval

| Ref | € | cm | h(cm) | ml | U.Venta |
|-------|-------|-----------|-------|------|---------|
| 63960 | 4,60 | 12x10 | 4,1 | 130 | 1 |
| 63971 | 8,00 | 16,3x12,3 | 4,7 | 220 | 1 |
| 63961 | 16,00 | 20,7x16,8 | 8,0 | 660 | 1 |
| 63962 | 25,00 | 24,2x20,6 | 9,3 | 1150 | 1 |



Bol cónico

Conique bol · Boul Konish
Conical bowl · Bacia cónica

| Ref | € | Ø (cm) | h(cm) | ml | U.Venta |
|-------|-------|--------|-------|------|---------|
| 63946 | 9,00 | 15,7 | 5,9 | 330 | 1 |
| 63947 | 11,00 | 18,3 | 6,8 | 560 | 1 |
| 63948 | 14,50 | 21,3 | 7,8 | 750 | 1 |
| 63949 | 20,40 | 24,2 | 8,8 | 1350 | 1 |



Bol salsa mini

Bol sauce mini · Boul sauce min
Sauce bowl mini · Bacia molho mini

| Ref | € | cm | h(cm) | ml | U.Venta |
|-------|------|---------|-------|----|---------|
| 63973 | 3,00 | 7,2x7,2 | 3,0 | 30 | 1 |



Classic Collection



• Una completa gama contemporánea en blanco y negro. Diseñada para realzar las creaciones del chef. Apilables, aptos para el lavavajillas y 100% libre de BPA.

• Une gamme contemporaine complète en noir et blanc. Conçue pour mettre en valeur les créations du chef. Empilables, ils passent au lave-vaisselle et sont 100 % sans BPA.

• A complete contemporary range in black and white. Designed to enhance the chef's creations. Stackable, dishwasher safe and 100% BPA free.



Bandeja rectangular S

Bandeja rectangular M

Bandeja rectangular L

| | Ref | € | cm | h(cm) | U.Venta |
|----------|-------|-------|-------|-------|---------|
| A | 63531 | 8,80 | 26x16 | 2 | 6 |
| | 63532 | 14,80 | 30x22 | 2 | 6 |
| B | 63541 | 8,80 | 26x16 | 2 | 6 |
| | 63542 | 14,80 | 30x22 | 2 | 6 |

| | Ref | € | cm | h(cm) | U.Venta |
|----------|-------|-------|-------|-------|---------|
| A | 63533 | 19,10 | 30x21 | 3 | 6 |
| | 63534 | 22,60 | 35x21 | 2 | 6 |
| B | 63543 | 19,10 | 30x21 | 3 | 6 |
| | 63544 | 23,30 | 35x21 | 2 | 6 |

| | Ref | € | cm | h(cm) | U.Venta |
|----------|-------|-------|-------|-------|---------|
| A | 63535 | 38,30 | 53x32 | 3 | 6 |
| | 63536 | 55,70 | 70x30 | 2 | 3 |
| B | 63545 | 38,70 | 53x32 | 3 | 6 |
| | 63546 | 55,70 | 70x30 | 2 | 3 |



Fuente oval

Plateau oval · Oval platte
Oval tray · Travessa redonda

| | Ref | € | cm | h (cm) | L | U.Venta |
|----------|-------|-------|---------|--------|------|---------|
| A | 63557 | 10,00 | 32x12 | 6 | 0,85 | 6 |
| | 63558 | 15,90 | 41,5x17 | 8 | 2,20 | 6 |
| B | 63567 | 10,00 | 32x12 | 6 | 0,85 | 6 |
| | 63568 | 15,90 | 41,5x17 | 8 | 2,20 | 6 |



Fuente pescado

Plateau poisson · Fischplatte
Fish tray · Travessa peixe

| | Ref | € | cm | h (cm) | U.Venta |
|----------|-------|-------|-------|--------|---------|
| A | 63589 | 31,30 | 57x22 | 4 | 1 |
| B | 63599 | 31,30 | 57x22 | 4 | 1 |



Bandeja delicatessen con mango

Plateau delicatessen · Schüssel delicatessen
Delicatessen tray · Bandeja delicatessen

| | Ref | € | cm | U.Venta |
|----------|-------|------|---------|---------|
| A | 63609 | 3,60 | 9,5x9,5 | 6 |
| B | 63619 | 3,60 | 9,5x9,5 | 6 |



Bandeja delicatessen

Plateau delicatessen · Schüssel delicatessen
Delicatessen tray · Bandeja delicatessen

| | Ref | € | cm | h (cm) | U.Venta |
|----------|-------|------|-------|--------|---------|
| A | 63610 | 3,10 | 10x10 | 2,5 | 6 |
| B | 63617 | 3,10 | 10x10 | 2,5 | 6 |

Fuente redonda White

Plateau rond · Rundplatte
Round tray · Travessa redonda

| | Ref | € | Ø (cm) | h(cm) | U.Venta |
|--|-------|-------|--------|-------|---------|
| | 63551 | 29,70 | 40,0 | 6,0 | 6 |
| | 63552 | 39,50 | 44,5 | 6,5 | 1 |



Fuente cuadrada White

Plateau rectangulaire · Serviertablet, rechteckig
Rectangular tray · Travessa quadrada

| | Ref | € | cm | h(cm) | L | U.Venta |
|--|-------|-------|-----------|-------|-----|---------|
| | 63573 | 29,00 | 33,5x33,5 | 8,5 | 5,0 | 1 |



Fuente White

Plateau · Serviertablet
Tray · Travessa

| | Ref | € | Ø (cm) | h(cm) | L | U.Venta |
|--|-------|-------|--------|-------|-----|---------|
| | 63577 | 27,30 | 35,5 | 11 | 4,0 | 6 |



Portatartas

Gueridon pâtisier · Kuchenplatte
Cake stand · Porta-tartes

| | Ref | € | Ø (cm) | h(cm) | U.Venta |
|--|-------|-------|--------|-------|---------|
| | 63586 | 33,40 | 30 | 9,0 | 4 |



Bol redondo White

Bol rond · Schale rund
Round bowl · Bacia redonda

| | Ref | € | Ø (cm) | h(cm) | L | U.Venta |
|--|-------|-------|--------|-------|------|---------|
| | 63553 | 16,20 | 22 | 10,0 | 2,4 | 6 |
| | 63554 | 24,00 | 28 | 10,0 | 4,0 | 6 |
| | 63555 | 33,40 | 33 | 13,0 | 7,0 | 6 |
| | 63556 | 41,50 | 38 | 14,5 | 11,0 | 2 |



Bol Oval White

Bol oval · Schale oval
Oval bowl · Bacia oval

| | Ref | € | cm | h(cm) | L | U.Venta |
|--|-------|-------|-------|-------|-----|---------|
| | 63585 | 24,30 | 29x26 | 16 | 4,0 | 6 |



Ribbed bol

Ribbed bol · Schale gerippt
Bowl Ribbed · Bacia Ribbed

| | Ref | € | Ø (cm) | h(cm) | L | U.Venta |
|--|-------|------|--------|-------|------|---------|
| | 63611 | 2,50 | 7,0 | 3 | 0,05 | 6 |
| | 63612 | 2,90 | 8,5 | 4 | 0,10 | 6 |



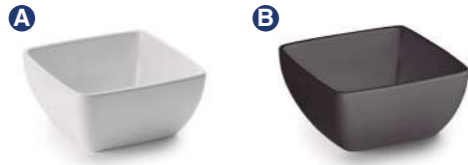

Bol ensalada
Bac salade · Schüssel
Salad bowl · Bacia de salada

| Ref | € | cm | h (cm) | L | U.Venta |
|-------|-------|-------|--------|-----|---------|
| 63570 | 8,10 | 13x13 | 6 | 0,5 | 6 |
| 63571 | 20,30 | 19x19 | 9 | 2,0 | 1 |
| 63572 | 39,60 | 25x25 | 12 | 4,8 | 1 |
| 63580 | 8,10 | 13x13 | 6 | 0,5 | 6 |
| 63581 | 20,30 | 19x19 | 9 | 2,0 | 1 |
| 63582 | 39,60 | 25x25 | 12 | 4,8 | 1 |

Bandeja oval
Plateau ovale · Servertablett oval
Oval tray · Bandeja oval

| Ref | € | cm | h (cm) | U.Venta |
|-------|-------|-----------|--------|---------|
| 62751 | 4,30 | 20,7x14,4 | 1,8 | 10 |
| 62753 | 6,40 | 25,0x18,3 | 2,2 | 10 |
| 62754 | 7,00 | 28,0x20,0 | 2,4 | 10 |
| 62755 | 8,20 | 31,4x23,4 | 2,5 | 10 |
| 62756 | 10,40 | 33,5x25,8 | 2,6 | 10 |
| 62757 | 11,50 | 32,6x28,5 | 2,7 | 10 |
| 62759 | 17,00 | 45,8x34,8 | 3,0 | 10 |



Bandeja redonda
Plateau rond · Servertablett rund
Round tray · Bandeja redonda

| Ref | € | Ø (cm) | h (cm) | U.Venta |
|-------|-------|--------|--------|---------|
| 62761 | 4,40 | 18,0 | 2,4 | 10 |
| 62762 | 5,20 | 20,0 | 2,5 | 10 |
| 62764 | 7,60 | 25,4 | 2,9 | 10 |
| 62766 | 12,50 | 30,7 | 3,3 | 10 |
| 62768 | 15,00 | 35,5 | 3,2 | 10 |
| 62769 | 21,60 | 40,0 | 3,5 | 6 |

Bandeja redonda ondulada
Plateau rond ondulé · Rund Teller gewellt
Undulated round plate · Prato redondo ondulado

| Ref | € | Ø (cm) | h (cm) | U.Venta |
|-------|-------|--------|--------|---------|
| 62770 | 6,60 | 20,7 | 2,8 | 10 |
| 62771 | 11,00 | 25,0 | 3,0 | 1 |
| 62772 | 12,80 | 29,5 | 3,1 | 1 |

Bandeja rectangular
Plateau rectangulaire · Servertablett, rechteckig
Rectangular tray · Bandeja rectangular

| Ref | € | cm | h (cm) | U.Venta |
|-------|-------|-----------|--------|---------|
| 62791 | 7,50 | 24,8x16,0 | 2,3 | 10 |
| 62792 | 10,90 | 28,0x19,0 | 2,3 | 10 |
| 62793 | 12,50 | 30,0x20,8 | 2,3 | 10 |



Bol redondo
Bac rond · Schüssel, rund
Round bowl · Bacia refondo

| Ref | € | Ø (cm) | h (cm) | L | U.Venta |
|-------|------|--------|--------|------|---------|
| 62785 | 3,80 | 11,8 | 5,1 | 0,30 | 10 |
| 62786 | 4,50 | 12,8 | 5,7 | 0,40 | 10 |
| 62787 | 5,30 | 14,9 | 6,5 | 0,60 | 10 |

Bol cuadrado
Bac carre · Schüssel, viereckig
Square bowl · Bacia quadrada

| Ref | € | cm | h (cm) | L | U.Venta |
|-------|-------|-----------|--------|------|---------|
| 62780 | 4,30 | 12,3x12,3 | 6,3 | 0,40 | 10 |
| 62781 | 5,00 | 14,9x14,9 | 7,0 | 0,70 | 10 |
| 62782 | 6,30 | 17,3x17,3 | 7,9 | 1,00 | 10 |
| 62783 | 8,20 | 19,7x19,7 | 8,8 | 1,50 | 1 |
| 62784 | 10,90 | 21,5x21,5 | 9,5 | 2,00 | 1 |



Cuchara lisa
Cuillère lisse · ServierLöffel
Plain spoon · Colher lisa

| Ref | € | Largo (cm) | U.Venta |
|-------|------|------------|---------|
| 63600 | 1,00 | 18 | 6 |



Cacillo
Louche · Schöpfkelle
Soup ladle · Concha

| Ref | € | Largo (cm) | ml | U.Venta |
|-------|------|------------|-----|---------|
| 63602 | 3,00 | 27 | 150 | 6 |
| 63605 | 3,00 | 27 | - | 6 |



Cuchara
Cuillère · Löffel
Spoon · Colher

| Ref | € | Largo (cm) | ml | U.Venta |
|-------|------|------------|----|---------|
| 63601 | 1,80 | 25 | 40 | 6 |
| 63604 | 2,60 | 30 | 50 | 6 |
| 63603 | 2,50 | 30 | - | 6 |

White & Black



- Fabricado en melamina de alta calidad. Libre de BPA.
- Diseñado para realizar las creaciones del chef.
- Ligero, resistente a golpes y choques térmicos.
- Higiénico y fácilmente lavable, apto para el lavavajillas.

- Fabriqué en mélamine de haute qualité. Sans BPA.
- Conçu pour améliorer les créations du chef.
- Léger, résistant aux coups et aux chocs thermiques.
- Hygiénique et facilement lavable, adapté au lave-vaisselle.

- Made of high quality melamine. BPA free.
- Designed to enhance the creations of the chef.
- Light, resistant to blows and thermal shocks.
- Hygienic and easily washable, suitable for dishwasher.



Bol cónico
Conique bol · Schale konisch
Conical bowl · Bacia cónica

| Ref | € | Ø (cm) | h (cm) | L | U.Venta |
|-------|-------|--------|--------|------|---------|
| 63261 | 9,90 | 17 | 7,0 | 0,70 | 6 |
| 63262 | 11,80 | 21 | 8,0 | 1,25 | 6 |
| 63263 | 13,50 | 25 | 8,5 | 1,80 | 6 |
| 63361 | 9,90 | 17 | 7,0 | 0,70 | 6 |
| 63362 | 11,80 | 21 | 8,0 | 1,25 | 6 |
| 63363 | 13,50 | 25 | 8,5 | 1,80 | 6 |



Bol redondo
Bac rond · Schüssel, rund
Round bowl · Bacia refondo

| Ref | € | Ø (cm) | h (cm) | L | U.Venta |
|-------|------|--------|--------|------|---------|
| 63264 | 7,80 | 12,5 | 7,5 | 0,45 | 6 |
| 63265 | 9,00 | 14,0 | 7,5 | 0,60 | 6 |
| 63364 | 7,80 | 12,5 | 7,5 | 0,45 | 6 |
| 63365 | 9,00 | 14,0 | 7,5 | 0,60 | 6 |

A

B

A

B

new

Bol oval
Bol oval · Oval bowl
Oval bowl · Bacia ova

| Ref | € | cm | h (cm) | L | U.Venta |
|-------|-------|-------|--------|------|---------|
| 63268 | 8,00 | 17x14 | 6 | 0,40 | 6 |
| 63269 | 18,00 | 24x20 | 9 | 1,70 | 6 |
| 63368 | 8,00 | 17x14 | 6 | 0,40 | 6 |
| 63369 | 18,00 | 24x20 | 9 | 1,70 | 6 |



Fuente redonda
Plateau rond · Rundplatte
Round tray · Travessa redonda

| Ref | € | Ø (cm) | h (cm) | L | U.Venta |
|-------|-------|--------|--------|-----|---------|
| 63267 | 30,60 | 31 | 8 | 3,0 | 6 |
| 63367 | 30,60 | 31 | 8 | 3,0 | 6 |

Bol luna
Bol · Schale
Bowl · Bacia

| Ref | € | Ø (cm) | h (cm) | U.Venta |
|-------|-------|--------|--------|---------|
| 63284 | 2,30 | 8 | 5,0 | 1 |
| 63285 | 10,70 | 16 | 9,5 | 1 |
| 63286 | 15,50 | 19 | 11,5 | 1 |
| 63404 | 2,30 | 8 | 5,0 | 1 |
| 63405 | 10,80 | 16 | 9,5 | 1 |
| 63406 | 15,50 | 19 | 11,5 | 1 |



Fuente oval
Plateau oval · Oval platte
Oval tray · Travessa redonda

| Ref | € | cm | h (cm) | U.Venta |
|-------|-------|-------|--------|---------|
| 63275 | 13,70 | 32x14 | 4 | 6 |
| 63375 | 13,70 | 32x14 | 4 | 6 |

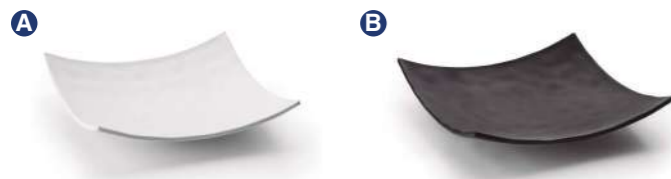

Fuente cuadrada

Plateau carrée · Quadratischen platte
Square tray · Travessa quadrado

| | Ref | € | cm | h (cm) | U.Venta |
|---|-------|-------|-------|--------|---------|
| A | 63272 | 7,60 | 19x19 | 4 | 6 |
| | 63273 | 16,30 | 25x25 | 5 | 6 |
| B | 63372 | 7,60 | 19x19 | 4 | 6 |
| | 63373 | 16,30 | 25x25 | 5 | 6 |



Bol salsa

Bac sauce · Schüssel saucen
Sauce bowl · Bacia molho

| | Ref | € | cm | h (cm) | L | U.Venta |
|---|-------|------|-------|--------|------|---------|
| A | 63270 | 6,10 | 14x12 | 5 | 0,25 | 6 |
| B | 63370 | 6,10 | 14x12 | 5 | 0,25 | 6 |



Fuente 3 salsas

Plateau 3 sauces · Serviertablet 3 sauces
3 sauces tray · Travessa 3 molhos

| | Ref | € | cm | h (cm) | U.Venta |
|---|-------|------|------|--------|---------|
| A | 63280 | 5,60 | 19x8 | 3 | 6 |
| B | 63380 | 5,60 | 19x8 | 3 | 6 |



Vaso

Timbale · Trinkbecher
Tumbler · Copo

| | Ref | € | Ø (cm) | h (cm) | L | U.Venta |
|---|-------|------|--------|--------|------|---------|
| A | 63350 | 3,50 | 7,3 | 7,7 | 0,32 | 1 |
| B | 63351 | 3,50 | 7,3 | 7,7 | 0,32 | 1 |



Fuente rectangular

Plateau rectangulaire · Serviertablet, rechteckig
Rectangular tray · Travessa rectangular

| | Ref | € | cm | h (cm) | U.Venta |
|---|-------|------|---------|--------|---------|
| A | 63274 | 9,90 | 25x17,5 | 3 | 6 |
| B | 63374 | 9,90 | 25x17,5 | 3 | 6 |



Fuente salsa mini

Plateau sauce mini · Serviertablet sauce mini
Sauce tray mini · Travessa molho min

| | Ref | € | cm | h (cm) | U.Venta |
|---|-------|------|-----|--------|---------|
| A | 63279 | 4,10 | 9x7 | 3 | 6 |
| B | 63379 | 4,10 | 9x7 | 3 | 6 |



Cuchara snack

Cuillère snack · Löffel snack
Snack spoon · Colher snack

| | Ref | € | cm | h (cm) | U.Venta |
|---|-------|------|-----------|--------|---------|
| A | 63287 | 3,70 | 14,5x14,5 | 4,5 | 1 |
| B | 63407 | 3,70 | 14,5x14,5 | 4,5 | 1 |

Bandeja 3 boles

Plateau avec 3 bols · Platte mit 3 Schalen
Tray with 3 bowls · Bandeja com 3 tijelas

| Ref | € | Ø (cm) | cm | h(cm) | ml | U.Venta |
|-------|-------|--------|-------|-------|----------|---------|
| 63403 | 14,60 | 8 | 27x11 | 1,0 | 120 (x3) | 1 |



Set 6 boles mini

Plateau avec 3 bols Black · Bandeja 3 Schalen Schwarz
Tray with 3 bowls Black · Bandeja 3 taças Preto

| Ref | € | Ø (cm) | h(cm) | U.Venta |
|-------|------|--------|-------|---------|
| 63408 | 9,40 | 6 | 7 | 1 |



Stone Collection



- Fabricado en melamina de alta calidad. Libre de BPA.
- Combina formas naturales con aspecto elegante parecido al mármol.
- Diseñado para realizar las creaciones del chef.
- Ligero, resistente a golpes y choques térmicos.
- Higiénico y fácilmente lavable, apto para el lavavajillas.

- Fabriqué en mélamine de haute qualité. Sans BPA.
- Il combine des formes naturelles avec une apparence élégante similaire au marbre.
- Conçu pour améliorer les créations du chef.
- Léger, résistant aux coups et aux chocs thermiques.
- Hygiénique et facilement lavable, adapté au lave-vaisselle.

- Made of high quality melamine. BPA free.
- It combines natural forms with elegant appearance similar to marble.
- Designed to enhance the creations of the chef.
- Light, resistant to blows and thermal shocks.
- Hygienic and easily washable, suitable for dishwasher.



Plato redondo

Plateau rond · Rund Plate
Round plate · Prato redondo

| Ref | € | Ø (cm) | h(cm) | U.Venta |
|-------|-------|--------|-------|---------|
| 63180 | 36,00 | 35 | 3,0 | 1 |
| 63181 | 54,90 | 44 | 3,0 | 1 |
| 63182 | 82,20 | 55 | 3,0 | 1 |



Bandeja cuadrada

Plateau carrée · Quadratischen platte
Square tray · Travessa quadrado

| Ref | € | cm | h(cm) | U.Venta |
|-------|-------|-----------|-------|---------|
| 63187 | 26,00 | 28,5x28,5 | 0,9 | 1 |



Bandeja rectangular

Plateau rectangulaire · Serviertablet, rechteckig
Rectangular tray · Bandeja rectangular

| Ref | € | cm | h(cm) | U.Venta |
|-------|-------|---------|-------|---------|
| 63188 | 31,30 | 35x28,5 | 0,9 | 1 |
| 63189 | 39,60 | 43x28,5 | 0,9 | 1 |
| 63190 | 58,70 | 53x32 | 0,9 | 1 |



Fuente oval

Carrée ovale · Schale oval
Oval tray · Travessa oval

| Ref | € | cm | h(cm) | U.Venta |
|-------|-------|-------|-------|---------|
| 63183 | 47,10 | 65x26 | 3,0 | 1 |



Fuente huevo

Plat oeufs · Eier platte
Egg plate · Travessa ovo

| Ref | € | cm | h(cm) | U.Venta |
|-------|-------|-----------|-------|---------|
| 63184 | 35,10 | 40,7x30,5 | 4,3 | 1 |



Tabla con mango

Planche avec manche · Servierbrett mit Griff
Board with grip · Tábua com mango

| Ref | € | cm | h(cm) | U.Venta |
|-------|-------|---------|-------|---------|
| 63185 | 24,00 | 40x19,5 | 0,9 | 1 |
| 63186 | 33,00 | 46x25 | 0,9 | 1 |



Fuente hoja

Palt feuille · Bratt platte
Leaf plate · Travessa folha

| Ref | € | cm | h(cm) | U.Venta |
|-------|-------|---------|-------|---------|
| 63191 | 22,00 | 40x25,3 | 4,3 | 1 |
| 63192 | 39,00 | 53x33 | 4,3 | 1 |

Wood Collection

new



- Fabricadas en melamina de máxima calidad, 100% libre de BPA.
- Ofrecen un aspecto muy natural parecido a la madera.
- Ideales para servir y presentar cualquier alimento.
- Ligeras y resistentes.
- Higiénicas y fáciles de limpiar, aptas para el lavavajillas.

- Fabriqués en mélamine de qualité supérieure, 100% sans BPA.
- Ils offrent un aspect bois très naturel.
- Idéals pour le service et la présentation de tous les aliments.
- Légers et résistants.
- Hygiéniques et faciles à nettoyer, ils passent au lave-vaisselle.

- Made of top quality melamine, 100% BPA free.
- They offer a very natural wood-like appearance.
- Ideal for serving and presenting any food.
- Light and resistant.
- Hygienic and easy to clean, dishwasher safe.



Bol rectangular

Bol rectangulaire · Rechteckige Schale
Rectangular bowl · Bacia rectangular

| Ref | € | cm | h(cm) | L | U.Venta |
|-------|-------|-----------|-------|------|---------|
| 63092 | 18,20 | 17,5x16 | 8,0 | 1,30 | 1 |
| 63093 | 30,70 | 32,5x17,5 | 8,0 | 3,00 | 1 |
| 63094 | 35,40 | 53x16 | 8,0 | 4,50 | 1 |



Bol redondo

Bol rond · Schale, rond
Round bowl · Bacia redonda

| Ref | € | Ø (cm) | h(cm) | L | U.Venta |
|-------|-------|--------|-------|------|---------|
| 63080 | 10,60 | 12,5 | 4,5 | 0,30 | 1 |
| 63081 | 15,20 | 15,5 | 5,5 | 0,50 | 1 |
| 63082 | 24,20 | 20,5 | 7,5 | 1,30 | 1 |



Bandeja serve

Plateau Serve · Serve Serviertablet
Serve tray · Bandeja Serve

| Ref | € | cm | h(cm) | U.Venta |
|-------|-------|---------|-------|---------|
| 63090 | 24,40 | 45x17,5 | 1,5 | 1 |
| 63091 | 32,70 | 53x20 | 1,5 | 1 |



Bandeja rectangular

Plateau rectangulaire · Serviertablet, rechteckige
Rectangular tray · Bandeja rectangular

| Ref | € | cm | h(cm) | U.Venta |
|-------|-------|-----------|-------|---------|
| 63086 | 20,50 | 32,5x17,5 | 1,0 | 1 |
| 63087 | 34,00 | 32,5x26,5 | 1,0 | 1 |
| 63088 | 65,70 | 53x32,5 | 1,0 | 1 |
| 63089 | 30,30 | 53x16 | 1,0 | 1 |



Plato redondo

Plateau rond · Plate, rond
Round plate · Prato redondo

| Ref | € | Ø (cm) | h(cm) | U.Venta |
|-------|-------|--------|-------|---------|
| 63083 | 6,10 | 15 | 1,5 | 1 |
| 63084 | 12,10 | 20 | 2,0 | 1 |
| 63085 | 20,10 | 26 | 2,2 | 1 |

Servicio mesa
Table service





Mini Serve Melamina

new



- **Mini cacerola con tapa fabricada en melamina de máxima calidad, 100% libre de BPA.**
- **Ofrece un aspecto muy natural parecido a la porcelana.**
- **Ideal para servir y presentar los platos más exquisitos.**
- **Ligera y resistente.**
- **Higiénica y fácil de limpiar, apta para el lavavajillas.**

- Mini-casserole avec couvercle en mélamine de qualité supérieure, 100 % sans BPA.
- Elle a un aspect très naturel, semblable à celui de la porcelaine.
- Idéale pour servir et présenter les plats les plus exquis.
- Légère et résistante.
- Hygiénique et facile à nettoyer, lavable au lave-vaisselle.

- Mini casseroles with lid made of top quality, 100% BPA-free melamine.
- Very natural porcelain-like appearance.
- Perfect for serving and presenting the most exquisite dishes.
- Lightweight and robust.
- Hygienic, easy to clean and dishwasher safe.

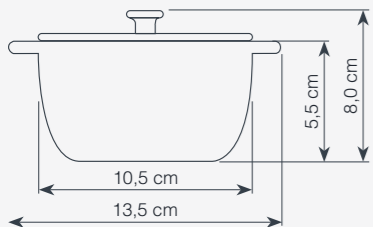

Mini cocotte Serve

Mini cocotte · Mini cocotte
Mini cocotte · Mini cocotte

| | Ref | € | cm | h(cm) | ml | Color | U.Venta |
|---|-------|-------|-----------|-------|-----|-------------|---------|
| A | 63200 | 20,10 | 13,5x10,5 | 5,5 | 350 | Rojo · Red | 1 |
| B | 63201 | 20,10 | 13,5x10,5 | 5,5 | 350 | Azul · Blue | 1 |
| C | 63202 | 20,10 | 13,5x10,5 | 5,5 | 350 | Gris · Grey | 1 |



Magma Melamina



- **Fabricadas en melamina de alta calidad.**
- **Libres de BPA.**
- **Ofrecen un aspecto muy natural parecido al hierro fundido.**
- **Ideales para servir y presentar los platos más exquisitos.**

- Fabriqué en mélamine de haute qualité.
- Sans BPA.
- Aspect très naturel, semblable à la fonte d'aluminium.
- Idéale pour servir et présenter les plats les plus exquis.

- Made of high quality melamine.
- BPA free.
- Very natural appearance similar to cast iron.
- Perfect for serving and presenting the most exquisite dishes.



Cacerola redonda

Faitout rond · Rund Bratentopf
Round casserole · Caçarola redonda

| Ref | € | Ø (cm) | U.Venta |
|-------|------|--------|---------|
| 63384 | 5,20 | 16 | 12 |
| 63385 | 6,40 | 18 | 12 |



Cacerola oval

Faitout ovale · Oval Bratentopf
Oval casserole · Caçarola roval

| Ref | € | cm | U.Venta |
|-------|------|-------|---------|
| 63388 | 4,60 | 18x12 | 12 |
| 63389 | 6,00 | 21x15 | 12 |



Wok

Wok · Wok
Wok · Wok

| Ref | € | Ø (cm) | U.Venta |
|-------|------|--------|---------|
| 63386 | 4,40 | 15 | 12 |
| 63387 | 6,10 | 18 | 12 |



Mini sartén

Mini pôele · Mini Pflanne
Mini frying pan · Mini sertã

| Ref | € | Ø (cm) | U.Venta |
|-------|------|--------|---------|
| 63381 | 7,20 | 15 | 6 |



Mini grill

Mini grill · Mini grill
Mini grill · Mini grill

| Ref | € | cm | U.Venta |
|-------|------|-----------|---------|
| 63382 | 7,60 | 13,5x13,5 | 6 |



Mini sartén rectangular

Mini pôele rectangulare · Mini Pflanne, rechteckiger
Rectangular Mini frying pan · Mini sertã rectangular

| Ref | € | cm | U.Venta |
|-------|------|---------|---------|
| 63383 | 5,20 | 17x11,5 | 12 |



Mini Cocotte Melamina

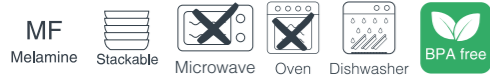

- Fabricada en melamina de alta calidad. Libre de BPA.
- Ofrece un aspecto muy natural parecido al hierro fundido.
- Ideal para servir y presentar los platos más exquisitos.

- Fabriqué en mélamine de haute qualité. Sans BPA.
- Il offre un aspect très naturel similaire à la fonte.
- Idéal pour servir et présenter les plats les plus exquis.

- Made of high quality melamine. BPA free.
- It offers a very natural aspect similar to cast iron.
- Ideal to serve and present the most exquisite dishes.

Cacerola Black

Faitout · Bratentopf
Casserole · Caçarola

| | Ref | € | Ø (cm) | h(cm) | ml | U.Venta |
|----------|-------|-------|--------|-------|-----|---------|
| A | 63390 | 4,50 | 9 | 4,5 | 150 | 1 |
| B | 63391 | 12,10 | 18x8,5 | 5,0 | 480 | 1 |
| C | 63392 | 11,40 | 10 | 4,5 | 210 | 1 |
| | 63393 | 20,60 | 14 | 6,5 | 640 | 1 |



Cacerola Red

Faitout · Bratentopf
Casserole · Caçarola

| | Ref | € | Ø (cm) | h(cm) | ml | U.Venta |
|----------|-------|-------|--------|-------|-----|---------|
| A | 63394 | 4,50 | 9 | 4,5 | 150 | 1 |
| B | 63395 | 12,10 | 18x8,5 | 5,0 | 480 | 1 |
| C | 63396 | 11,40 | 10 | 4,5 | 210 | 1 |
| | 63397 | 20,60 | 14 | 6,5 | 640 | 1 |



Cacerola Grey

Faitout · Bratentopf
Casserole · Caçarola

| | Ref | € | Ø (cm) | h(cm) | ml | U.Venta |
|----------|-------|-------|--------|-------|-----|---------|
| A | 63398 | 4,50 | 9 | 4,5 | 150 | 1 |
| B | 63399 | 12,10 | 18x8,5 | 5,0 | 480 | 1 |
| C | 63400 | 11,40 | 10 | 4,5 | 210 | 1 |
| | 63401 | 20,60 | 14 | 6,5 | 640 | 1 |



Batería Mini



Cacerola con tapa

Faitout avec couvercle · Bratentopf mit Deckel
Casserole with lid · Caçarola com tampa

| Ref | € | Ø (cm) | Ød (cm) | h(cm) | L | U.Venta |
|-------|-------|--------|---------|-------|-----|---------|
| 25160 | 21,50 | 16 | 12 | 5,0 | 0,8 | 1 |



Cazo

Casserole · Stielkasserole, flach
Saucepan · Caçarola direita

| Ref | € | Ø (cm) | Ød (cm) | h(cm) | L | U.Venta |
|-------|-------|--------|---------|-------|-----|---------|
| 25164 | 16,60 | 14 | 10 | 8,0 | 1,0 | 1 |



Paellera

Plat à paella · Pfanne
Round dish · Paelheira

| Ref | € | Ø (cm) | Ød (cm) | h(cm) | L | U.Venta |
|-------|-------|--------|---------|-------|-----|---------|
| 25161 | 21,50 | 20 | 11,5 | 4,5 | 1,0 | 1 |



Sartén

Poêle · Pfanne
Frying pan · Sertã

| Ref | € | Ø (cm) | Ød (cm) | h(cm) | U.Venta |
|-------|-------|--------|---------|-------|---------|
| 25163 | 13,20 | 14 | 10,0 | 3,0 | 1 |



Grill

Grill · Grill Induktionfähig
Grill · Grelhador

| Ref | € | cm | Ød (cm) | h(cm) | U.Venta |
|-------|-------|-------|---------|-------|---------|
| 25162 | 14,50 | 14x14 | 10,0 | 2,5 | 1 |



Mini Cocottes



HINWEIS: In Deutschland nicht verfügbar

- Fabricada en aluminio fundido. Diseño atractivo y funcional.
- Garantiza la absorción y distribución uniforme del calor, sin puntos de sobrecalentamiento.
- La distribución del calor uniforme por toda la pieza hace que los alimentos no pierdan su jugo durante la cocción, conservando así todos sus nutrientes y vitaminas.
- Es la pieza perfecta para: arroces, carnes, pescados, legumbres, verduras, guisos, cremas, salsas, sopas, etc.
- Revestimiento antiadherente ILAG:ULTIMATE.

- Fabriqué en aluminium fondu. Conception attrayante et fonctionnelle.
- Il garantit l'absorption et la distribution uniformes de la chaleur, sans surchauffe.
- La distribution de la chaleur uniforme dans toute la pièce fait que les aliments ne perdent pas leur jus pendant la cuisson, conservant ainsi tous ses nutriments et vitamines.
- C'est la pièce parfaite pour: le riz, les viandes, le poisson, les légumineuses, les légumes, les ragoûts, les crèmes, les sauces, les soupes, etc.
- Ilag: Ultime.

- Manufactured in molten aluminum. Attractive and functional design.
- It guarantees the uniform absorption and distribution of heat, without overheating points.
- The distribution of uniform heat throughout the piece causes food not to lose their juice during cooking, thus retaining all its nutrients and vitamins.
- It is the perfect piece for: rice, meats, fish, legumes, vegetables, stews, creams, sauces, soups, etc.
- Ilag: Ultimate.

Cacerola con tapa Mini

Faitout avec couvercle "MINI" · "MINI" Bratentopf mit Deckel
"MINI" round casserole with lid · Caçarola com tampa "MINI"

| | Ref | € | Ø (cm) | h(cm) | L | U.Venta |
|----------|-------|-------|--------|-------|------|---------|
| A | 25909 | 23,10 | 10 | 5,0 | 0,24 | 12 |
| | 25914 | 33,90 | 14 | 7,5 | 0,90 | 1 |
| B | 25910 | 23,10 | 10 | 5,0 | 0,24 | 1 |
| | 25915 | 33,90 | 14 | 7,5 | 0,90 | 1 |



Cacerola oval con tapa Mini

Faitout Ovale avec couvercle "MINI" · "MINI" Oval Bratentopf mit Deckel
"MINI" oval round casserole with lid · Caçarola oval com tampa "MINI"

| | Ref | € | Ø (cm) | h(cm) | L | U.Venta |
|----------|-------|-------|--------|-------|------|---------|
| A | 25911 | 24,30 | 12x8,5 | 5,0 | 0,25 | 1 |
| B | 25912 | 23,00 | 12x8,5 | 5,0 | 0,25 | 1 |



Magma Collection



- Construida en una sola pieza.
- Recubierta con una capa de aceite vegetal.
- Ideal para cocinar, prolonga suavemente la cocción.
- Gran conductor del calor, mantiene el calor mientras disfrutas y saboreas la comida.
- Base de madera para servir y presentar la comida recién cocinada.

- Construit en un seul morceau.
- Recouvert d'une couche d'huile végétale.
- Idéal pour la cuisine, la cuisine doucement prolongée.
- Excellent conducteur de chaleur, gardez la chaleur tout en profitant et sauvant la nourriture.
- Base de bois pour servir et présenter des aliments fraîchement cuits.

- Built in one piece.
- Covered with a layer of vegetable oil.
- Ideal for cooking, gently prolonged cooking.
- Great heat driver, keep heat while enjoying and savors the food.
- Wood base to serve and present freshly cooked food.



Cacerola

Faitout · Bratentopf
Casserola · Caçarola

| Ref | € | Ø (cm) | ml | U.Venta |
|-------|-------|--------|-----|---------|
| 25771 | 11,00 | 12,5 | 230 | 4 |
| 25772 | 16,00 | 16,2 | 470 | 4 |
| 25773 | 19,30 | 18,5 | 720 | 1 |



Cacerola con base

Faitout avec basse · Bratentopf mit Holzsockel
Casserola with base · Caçarola com base

| Ref | € | Ø (cm) | ml | U.Venta |
|-------|-------|--------|-----|---------|
| 25871 | 15,80 | 12,5 | 230 | 4 |
| 25872 | 21,60 | 16,2 | 470 | 1 |
| 25873 | 27,70 | 18,5 | 720 | 1 |



Cacerola oval

Faitout ovale · Oval Bratentopf
Oval casserola · Caçarola oval

| Ref | € | cm | ml | U.Venta |
|-------|-------|-----------|-----|---------|
| 25781 | 12,40 | 15x10 | 200 | 4 |
| 25782 | 19,50 | 17,5x12,5 | 300 | 1 |
| 25783 | 22,20 | 21,7x15 | 700 | 1 |



Cacerola oval con base

Faitout ovale avec basse · Oval Bratentopf mit Holzsockel
Oval casserola with base · Caçarola oval com base

| Ref | € | cm | ml | U.Venta |
|-------|-------|-----------|-----|---------|
| 25881 | 16,00 | 15x10 | 200 | 4 |
| 25882 | 24,70 | 17,5x12,5 | 300 | 1 |
| 25883 | 27,40 | 21,7x15 | 700 | 1 |



Mini plancha rectangular

Mini plaque grill lisse rectangulaire · Mini Platte Grill, glatt, rechteckiger
Mini rectangular grill plaque flat · Mini plancha grill liso rectangular

| Ref | € | cm | U.Venta |
|-------|-------|-------|---------|
| 25774 | 10,50 | 17x10 | 4 |



Mini plancha rectangular con base

Mini plaque Grill lisse rectang. a/basse · Mini Platte Grill, glatt, rechteckiger m/Holzsockel
Mini rectangular grill plaque flat with base · Mini plancha grill liso rectangular c/base

| Ref | € | cm | h(cm) | U.Venta |
|-------|-------|-------|-------|---------|
| 25874 | 15,40 | 17x10 | 2,5 | 4 |



Mini plancha grill cuadrado

Mini plaque grill carré · Mini Platte Grill, Quadrat
Mini square grill plaque · Mini plancha grill quadrado

| Ref | € | cm | h(cm) | U.Venta |
|-------|-------|-------|-------|---------|
| 25775 | 11,00 | 14x14 | 1,7 | 4 |



Mini grill

Mini grill · Mini Grill
Mini grill · Mini grill

| Ref | € | cm | h(cm) | U.Venta |
|-------|-------|-------|-------|---------|
| 25776 | 11,40 | 14x14 | 2,5 | 4 |



Mini sartén lisa

Mini poêle lisse · Mini Pfanne
Mini frying pan flat · Mini sertã lisa

| Ref | € | Ø (cm) | h(cm) | U.Venta |
|-------|-------|--------|-------|---------|
| 25777 | 11,50 | 13 | 1,7 | 4 |



Mini plancha grill cuadrado con base

Mini plaque grill carré avec basse · Mini Platte Grill, Quadrat mit Holzsockel
Mini square grill plaque with base · Mini plancha grill quadrado com base

| Ref | € | cm | h(cm) | U.Venta |
|-------|-------|-------|-------|---------|
| 25875 | 15,40 | 14x14 | 1,7 | 4 |



Mini grill con base

Mini grill avec basse · Mini Grill mit Holzsockel
Mini grill with base · Mini grill com base

| Ref | € | cm | h(cm) | U.Venta |
|-------|-------|-------|-------|---------|
| 25876 | 17,80 | 14x14 | 2,5 | 1 |



Mini sartén lisa con base

Mini poêle lisse avec basse · Mini Pfanne mit Holzsockel
Mini frying pan flat with base · Mini sertã lisa com base

| Ref | € | Ø (cm) | h(cm) | U.Venta |
|-------|-------|--------|-------|---------|
| 25877 | 16,50 | 13 | 1,7 | 1 |

Mango desmontable
Removable handle

new



Bandeja oval con mango y base

Plateau ovale avec manche et base · Ovale tablett mit griff und basis
Oval tray with handle and base · Bandeja oval com cabo e base

| Ref | € | cm | h (cm) | U.Venta |
|-------|-------|-------|--------|---------|
| 25867 | 18,10 | 24x14 | 2,2 | 1 |

Magma Grey & Red



- Acabado exterior e interior esmaltado, muy resistente y de gran durabilidad.
- Muy versátil: ideal para cocinar asados, arroces, pasta, cocer a fuego lento e incluso hornear tartas dulces y pan.
- Conserva todos los nutrientes, vitaminas y sabores de los alimentos.
- Excelente retención y distribución uniforme del calor.
- Incluye base de madera, ideal para servir y presentar.
- Apta para todo tipo de fuegos.

- Finition émaillée extérieure et intérieure, très résistante et d'une grande durabilité.
- Très polyvalent: idéal pour cuisiner des rôtis, du riz, des pâtes, cuire à feu doux et même cuire des gâteaux sucrés et à pain.
- Gardez tous les nutriments, vitamines et saveurs des aliments.
- Excellente rétention et distribution uniforme de la chaleur.
- Comprend la base en bois, idéale pour servir et présenter.

- Convient à tous les types d'incendies.
- Exterior and interior enameled finish, very resistant and of great durability.
- Very versatile: Ideal for cooking roasts, rice, pasta, cook over low heat and even bake sweet and bread cakes.
- Keep all nutrients, vitamins and flavors of food.
- Excellent retention and uniform distribution of heat.
- Includes wood base, ideal to serve and present.
- Suitable for all types of fires.



Cacerola redonda

Faitout rond · Rund Bratentopf
Round casserole · Caçarola redonda

| | Ref | € | Ø (cm) | h(cm) | ml | U.Venta |
|---|-------|-------|--------|-------|-----|---------|
| A | 25841 | 18,10 | 12,0 | 3,0 | 200 | 1 |
| | 25848 | 28,10 | 16,2 | 3,0 | 470 | 1 |
| | 25849 | 34,80 | 18,5 | 3,0 | 720 | 1 |
| B | 25851 | 18,10 | 12,0 | 3,0 | 200 | 1 |
| | 25858 | 28,10 | 16,2 | 3,0 | 470 | 1 |
| | 25859 | 34,80 | 18,5 | 3,0 | 720 | 1 |

Cacerola oval

Faitout ovale · Oval Bratentopf
Oval casserole · Caçarola oval

| | Ref | € | cm | h(cm) | ml | U.Venta |
|---|-------|-------|-----------|-------|-----|---------|
| A | 25842 | 24,10 | 17,5x12,5 | 3,0 | 250 | 1 |
| | 25840 | 34,70 | 21,7x15 | 3,0 | 700 | 1 |
| | 25852 | 24,30 | 17,5x12,5 | 3,0 | 250 | 1 |
| B | 25850 | 35,00 | 21,7x15 | 3,0 | 700 | 1 |



Sartén

Poêle · Pfanne
Frying pan · Sertä

| | Ref | € | Ø (cm) | h(cm) | ml | U.Venta |
|---|-------|-------|--------|-------|-----|---------|
| A | 25843 | 18,20 | 13,5 | 3,0 | 275 | 1 |
| B | 25853 | 18,20 | 13,5 | 3,0 | 275 | 1 |

Cacerola redonda con tapa

Faitout rond avec couvercle · Rund Bratentopf mit Deckel
Round casserole with lid · Caçarola redonda com tampa

| | Ref | € | Ø (cm) | h(cm) | ml | U.Venta |
|---|-------|-------|--------|-------|-----|---------|
| A | 25846 | 29,30 | 10 | 5,0 | 200 | 1 |
| B | 25856 | 29,30 | 10 | 5,0 | 200 | 1 |

Cacerola oval con tapa

Faitout ovale avec couvercle · Oval Bratentopf mit Deckel
Oval casserole with lid · Caçarola oval com tampa

| | Ref | € | cm | h(cm) | ml | U.Venta |
|---|-------|-------|-------|-------|-----|---------|
| A | 25847 | 34,70 | 13x10 | 5,0 | 400 | 1 |
| B | 25857 | 34,70 | 13x10 | 5,0 | 400 | 1 |



Presentación



Fuente 5 compartimentos Zensai

Plat 5 compartiments · Platte mit 5 Fächern
5-compartment tray · Travessa com 5 compartimentos

| Ref | € | Ø (cm) | h(cm) | Compart | U.Venta |
|-------|------|--------|-------|---------|---------|
| 61242 | 9,70 | 25,5 | 4,0 | 5 | 1 |



Bandeja con cuencos Basic

Plateau avec bols · Tablett mit Schüsseln
Tray with bowls · Bandeja com taças

| | Ref | € | Base (cm) | Cuenco (cm) | ml |
|---|-------|-------|-----------|-------------|----|
| A | 61240 | 7,50 | 28x10x1 | 100 (x3) | 1 |
| B | 61241 | 7,50 | 28x10x1 | 90 (x3) | 1 |
| C | 61243 | 22,30 | Ø26x1 | - | 1 |



Bandeja Olive

Plateau · Tablett
Tray · Bandeja

| Ref | € | cm | U.Venta |
|-------|------|------|---------|
| 61244 | 4,80 | 19x9 | 1 |



Set 3 ramequines

Ensemble de 3 ramequins · 3 kleine Auflaufformen
Set of 3 ramekins · Conjunto de 3 ramequines

| Ref | € | Ø (cm) | h(cm) | ml | U.Venta |
|-------|------|--------|-------|-----|---------|
| 61239 | 6,00 | 9 | 5 | 130 | 1 |



Bandeja Share

Plateau · Tablett
Tray · Bandeja

| Ref | € | cm | h(cm) | U.Venta |
|-------|-------|---------|-------|---------|
| 61245 | 15,20 | 38,5x10 | 4,8 | 1 |



Tabla mármol y bambú

Planche marbre & bambou · Marmor & bambusbrett
Marble & bamboo board · Tábua mármore & bambu

| Ref | € | Tabla (cm) | Mármol (cm) | Cuenco (cm) | ml | U.Venta |
|-------|-------|------------|-------------|-------------|----------|---------|
| 61040 | 18,70 | 28x28x1,5 | 24,5x15x1 | Ø8x3 | 100 (x3) | 1 |



Tabla pizarra & bambú con cuencos

Planche ardoise & bambou · Schiefer & bambusbrett
Tábua ardósia & bambu · Slate & bamboo board

| Ref | € | Tabla (cm) | ml | U.Venta |
|-------|-------|------------|----|---------|
| 61042 | 18,90 | 28x28x1,5 | 56 | 1 |

Tabla pizarra & bambú

Planche ardoise & bambou · Schiefer & bambusbrett
Slate & bamboo board · Tábua ardósia & bambu

| | Ref | € | Tabla (cm) | Pizarra (cm) | U.Venta |
|----------|-------|-------|-------------|--------------|---------|
| A | 61045 | 7,50 | 40x10x1,5 | 25x7,5 | 1 |
| B | 61046 | 15,00 | 50x18x1,5 | 35x15 | 4 |
| C | 61047 | 20,20 | 38,5x28x1,5 | Ø25 | 12 |

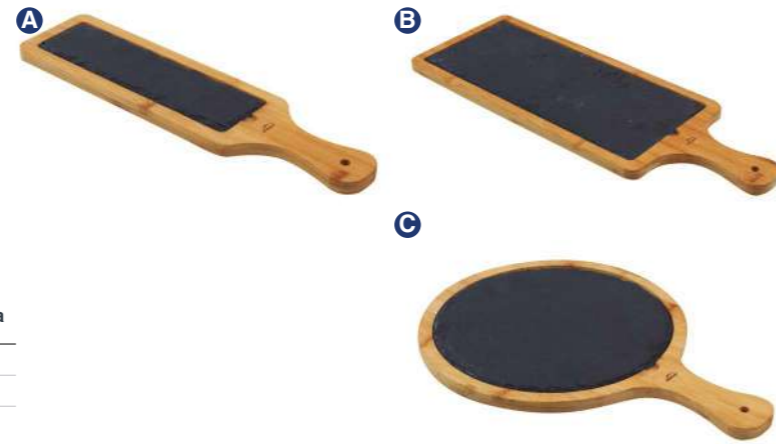

Miniaturas y cestillos



Reversible
Reversible

MF Melamine Stackable Dishwasher BPA free

Soporte para tacos

Support de tacos · Tacos Unterstützung
Tacos support · Suporte de tacos

| | Ref | € | Tacos | cm | h(cm) | U.Venta |
|----------|-------|------|-------|------|-------|---------|
| A | 63281 | 4,10 | 1-2 | 12x6 | 4 | 1 |
| B | 63282 | 4,70 | 2-3 | 18x6 | 4 | 1 |
| C | 63283 | 5,60 | 3-4 | 23x6 | 4 | 1 |



ABEDUL Birch Dishwasher

Mini pallet presentación

Mini palette de présentation · Minipalette für Präsentation
Mini pallet for presentation · Mini palette de apresentação

| | Ref | € | cm | h(cm) | U.Venta |
|--|-------|-------|-------|-------|---------|
| | 61060 | 6,70 | 13x8 | 3,0 | 1 |
| | 61059 | 8,90 | 20x12 | 3,0 | 1 |
| | 61058 | 11,90 | 30x20 | 3,0 | 1 |
| | 61057 | 13,70 | 40x15 | 3,0 | 1 |

Vitro Electric Gas Dishwasher ECO PFOA free

Colección Smart

Plat à paella · Paellapfanne, emailliert
Round dish for paelle · Paelheira esmaltada

| | Ref | € | Ø (cm) | U.Venta |
|----------|-------|------|--------|---------|
| A | 60170 | 5,20 | 10 | 1 |
| | 60172 | 5,90 | 12 | 1 |
| | 60175 | 6,90 | 15 | 1 |
| | 60180 | 8,80 | 20 | 1 |
| B | 60192 | 6,70 | 12 | 1 |
| | 60196 | 7,90 | 16 | 1 |
| | 60190 | 8,70 | 20 | 1 |



INOX

Mini cubo

Mini-cube · Mini-Eimer
Mini cube · Mini cubo

| | Ref | € | Ø (cm) | h(cm) | ml | U.Venta |
|----------|-------|------|--------|-------|-----|---------|
| A | 61107 | 4,90 | 7 | 7,0 | 200 | 12 |
| B | 61109 | 5,90 | 9 | 9,0 | 340 | 1 |
| C | 61112 | 7,60 | 12 | 12,0 | 900 | 1 |



INOX Dishwasher

Cestillo redondo

Panier rond · Korb, Rund
Round basket · Cesta redonda

| | Ref | € | Ø (cm) | h(cm) | U.Venta |
|----------|-------|------|--------|-------|---------|
| A | 61009 | 8,90 | 9 | 8,0 | 6 |
| B | 61069 | 8,90 | 9 | 8,0 | 6 |
| C | 61150 | 8,70 | 9 | 8,0 | 6 |



Cestillo cuadrado

Panier carré · Korb, quadratisch
Square basket · Cesta quadrada

| | Ref | € | cm | h(cm) | U.Venta |
|----------|-------|-------|-------|-------|---------|
| A | 61007 | 8,90 | 10x8 | 7,0 | 6 |
| | 61052 | 11,50 | 12x10 | 9,0 | 6 |
| B | 61067 | 8,90 | 10x8 | 7,0 | 6 |
| | 61062 | 11,50 | 12x10 | 9,0 | 6 |
| C | 61151 | 8,70 | 10x8 | 7,0 | 6 |
| | 61152 | 11,20 | 12x10 | 9,0 | 6 |



Cestillo cónico

Panier conique · Korb, Konisch
Conical basket · Cesta cónica

| | Ref | € | Ø (cm) | h(cm) | U.Venta |
|----------|-------|------|--------|-------|---------|
| A | 61053 | 9,90 | 12 | 10,0 | 6 |
| B | 61063 | 9,90 | 12 | 10,0 | 6 |
| C | 61153 | 9,60 | 12 | 10,0 | 6 |



Cestillo rectangular

Panier rectangulaire · Korb, rechteckig
Rectangular basket · Cesta rectangular

| | Ref | € | cm | h(cm) | U.Venta |
|----------|-------|-------|-------|-------|---------|
| A | 61056 | 13,40 | 21x11 | 6,0 | 1 |
| B | 61066 | 13,40 | 21x11 | 6,0 | 1 |
| C | 61155 | 12,90 | 21x11 | 6,0 | 1 |



Cestillo rectangular con asas

Panier rectangulaire a/poignées · Korb, rechteckig mit Griffen
Rectangular basket with handles · Cesta rectangular com alças

| | Ref | € | cm | h(cm) | U.Venta |
|----------|-------|-------|-------|-------|---------|
| A | 61055 | 13,40 | 21x11 | 6,0 | 1 |
| B | 61065 | 13,40 | 21x11 | 6,0 | 1 |
| C | 61154 | 12,90 | 21x11 | 6,0 | 1 |



Paneras y fruteros



- Tapa fabricada en madera de caucho con orificios de ventilación para una óptima circulación del aire.
- 2 en 1: la tapa de madera de caucho se puede utilizar como tabla de cortar.

- Cover made of rubber wood with ventilation holes for optimal air circulation.
- 2 in 1: The rubber wood lid can be used as a cutting table.



RUBBER WOOD

Panera nórdica

Boîte à pain · Brotkasten
Bread basket · Caixa para guardar pão

| Ref | € | cm | h(cm) | U.Venta |
|----------------|--------------|---------|-------|---------|
| A 62868 | 39,60 | 30x18 | 12,5 | 1 |
| B 62869 | 43,00 | 42x22,5 | 12,5 | 1 |



- Fabricada en fibra virgen natural.
- Material ecológico y respetuoso con el medio ambiente.
- Lavable, resistente y duradera.
- Diseñada y fabricada en España.
- Hecha a mano.
- Tacto agradable y suave, similar a la piel. Espesor 0,55 mm.

- Fabriqué en fibre vierge naturelle.
- Matériel écologique et environnemental.
- Lavable, résistant et durable.
- Conçu et fabriqué en Espagne.
- Fait main.
- Un toucher agréable et doux, similaire à la peau. 0,55 mm d'épaisseur.

- Manufactured in natural virgin fiber.
- Ecological and environmental material.
- Washable, resistant and lasting.
- Designed and manufactured in Spain.
- Handmade.
- Nice and soft touch, similar to the skin. 0.55 mm thickness.



INOX

Frutero - Panera inox

Panier à fruit et à pain · Brot-/Obstschale
Fruits and bread basket · Fruteiro-Cesto

| Ref | € | Ø (cm) | U.Venta |
|-------|--------------|--------|---------|
| 61821 | 7,70 | 20 | 1 |
| 61823 | 11,60 | 24 | 1 |



Panera kraft

Boîte à pain · Brotkasten
Bread basket · Caixa para guardar pão

| Ref | € | cm | h max (cm) | h min (cm) | U.Venta |
|----------------|--------------|-------|------------|------------|---------|
| A 63476 | 13,80 | 10x10 | 25 | 8 | 1 |
| B 63477 | 14,70 | 12x12 | 25 | 12 | 1 |
| C 63478 | 16,60 | 15x15 | 25 | 12 | 1 |
| D 63479 | 19,20 | 20x20 | 33 | 12 | 1 |



Panera Tex

Boîte à pain · Brotkasten
Bread basket · Caixa para guardar pão

| Ref | € | cm | h max (cm) | h min (cm) | U.Venta |
|----------------|--------------|-------|------------|------------|---------|
| A 63486 | 13,80 | 10x10 | 25 | 8 | 1 |
| B 63487 | 14,70 | 12x12 | 25 | 12 | 1 |
| C 63488 | 16,60 | 15x15 | 25 | 12 | 1 |
| D 63489 | 19,20 | 20x20 | 33 | 12 | 1 |



Estructura de refuerzo de acero inoxidable
Stainless steel reinforcement structure



- Cesta para pan fabricada en polipropileno. Diseñada para uso intensivo.
- Estructura de refuerzo de acero inoxidable. Parte trasera más alta que proporciona suficiente apoyo para panes largos.
- Material con aspecto de mimbre muy resistente, libre de BPA.
- Elaborada a mano. Práctica e higiénica. Acabado en mate.
- Ideal para almacenar y exponer panes.
- Apilable.

- Panier à pain fabriqué en polypropylène. Conçu pour une utilisation intensive.
- Structure d'armature en acier inoxydable. L'arrière le plus élevé qui fournit un soutien solide aux pains longs.
- Matériau très résistant en osier, sans BPA.
- Fait main. Pratique et hygiénique. Finition mate.
- Idéal pour stocker et exposer le pain.
- Empilable.

- Bread basket manufactured in polypropylene. Designed for intensive use.
- Stainless steel reinforcement structure. Highest rear that provides suicide support for long breads.
- Very resistant wicker -like material, BPA free.
- Handmade. Practice and hygienic. Matte finish.
- Ideal to store and expose bread.
- Stackable.

Cesta baguette

Corbeille · Brotkorb
Basket · Cesta

| Ref | € | A (cm) | B (cm) | C (cm) | D (cm) | E (cm) | U.Venta |
|----------------|--------------|--------|--------|--------|--------|--------|---------|
| A 63492 | 64,40 | 32,0 | 28,5 | 42,0 | 25,0 | 36,5 | 1 |
| B 63493 | 64,40 | 32,0 | 28,5 | 42,0 | 25,0 | 36,5 | 1 |



Cesta de pan redonda

Corbeille a pain ronde · Brotkorb, rund
Round bread basket · Cesta de pão redonda

| Ref | € | Ø (cm) | h(cm) | U.Venta |
|----------------|--------------|--------|-------|---------|
| 63471 | 7,90 | 19 | 8 | 1 |
| A 63472 | 8,80 | 21 | 8 | 1 |
| 63473 | 9,40 | 23 | 8 | 1 |
| 63474 | 10,10 | 28 | 8 | 1 |
| 63871 | 8,00 | 19 | 8 | 1 |
| B 63872 | 8,80 | 21 | 8 | 1 |
| 63873 | 9,40 | 23 | 8 | 1 |
| 63874 | 10,20 | 26 | 8 | 1 |



Cesta de pan

Corbeille a pain · Brotkorb
Bread basket · Cesta de pão

| Ref | € | Ø (cm) | h (cm) | U.Venta |
|----------------|--------------|--------|--------|---------|
| A 63494 | 30,80 | 35 | 20 | 1 |
| B 63894 | 30,30 | 35 | 20 | 1 |

Cesta de pan oval

Corbeille a pain ovale · Brotkorb, Oval
Oval bread basket · Cesta de pão oval

| Ref | € | cm | h(cm) | U.Venta |
|----------------|--------------|-------|-------|---------|
| 63480 | 7,20 | 19x14 | 8,0 | 1 |
| A 63481 | 8,50 | 24x17 | 8,0 | 1 |
| 63482 | 10,40 | 28x16 | 8,5 | 1 |
| 63880 | 7,20 | 19x14 | 8,0 | 1 |
| B 63881 | 8,40 | 24x17 | 8,0 | 1 |
| 63882 | 10,40 | 28x16 | 8,5 | 1 |



Cesta de pan cuadrada

Corbeille a pain carré · Brotkorb, viereckig
Square bread basket · Cesta de pão quadrada

| Ref | € | cm | h (cm) | U.Venta |
|----------------|--------------|---------|--------|---------|
| A 63490 | 35,20 | 53x33,5 | 9 | 1 |
| B 63890 | 34,90 | 53x33,5 | 9 | 1 |



- Diseño transpirable.
- Versátil: ideal para fruta, verdura, tarros de conservas, frutos secos, huevos, etc.

- The breathable design.
- Versatile: perfect for fruit, vegetables, canning jars, etc.

Medidas · Sizes
19,5x17,5x7 cm

Medidas · Sizes
29x18x8 cm



RUBBER WOOD
FE
Iron

Frutero varillas Dual

Corbeille à fruits · Obstschale aus Gitterstäben
Rod fruit bowl · Cesto de metal para fruta



| Ref | € | Ø superior (cm) | Ø inferior (cm) | h(cm) | Diámetro varilla (mm) | U.Venta |
|-------|-------|-----------------|-----------------|-------|-----------------------|---------|
| 61140 | 54,90 | Ø40x10 | Ø24x10 | 63 | 4 | 1 |

Frutero Dual SQ

Corbeille à fruits · Obstkorb
Fruit basket · Fruteira

| Ref | € | cm | h(cm) | U.Venta |
|-------|-------|---------|-------|---------|
| 61124 | 19,30 | 29x18,5 | 33,5 | 4 |

Madera contrachapada color haya
Plywood beech color



FE
Iron

Frutero varilla mango

Corbeille à fruits · Obstschale aus Gitterstäben
Square fruit bowl · Cesto de metal para fruta

| Ref | € | h (cm) | Diámetro varilla (mm) | U.Venta |
|----------------|-------|--------|-----------------------|---------|
| A 61137 | 35,30 | 28 | 4 | 1 |
| B 61138 | 35,30 | 29 | 4 | 1 |

Ideales para almacenar fruta, pan, verduras, huevos, etc.
Can be used for storing fruit, bread, vegetables, eggs, etc.



FE
Iron

Frutero varillas

Corbeille à fruits · Obstschale aus Gitterstäben
Square fruit bowl · Cesto de metal para fruta

| Ref | € | Ø (cm) | h (cm) | Diámetro varilla (mm) | U.Venta |
|----------------|-------|--------|--------|-----------------------|---------|
| A 61126 | 23,50 | 23,5 | 25,5 | 4 | 2 |
| B 61127 | 21,40 | 27,0 | 14,0 | 4 | 1 |
| C 61128 | 22,60 | 34,0 | 9,5 | 4 | 1 |



Madera aglomerada
Agglomerate wood



FE
Iron

Frutero varillas redondo bajo

Corbeille à fruits ronde basse · Obstschale aus Gitterstäben
Round low rod fruit bowl · Cesto de metal para fruta redondo baixo

| Ref | € | Diámetro varilla (mm) | Ø superior (cm) | Base (cm) | h(cm) | U.Venta |
|-------|-------|-----------------------|-----------------|-----------|-------|---------|
| 61139 | 40,80 | 4 | 39 | 31,3 | 7,6 | 1 |

Mesa

INOX 18/10
Dishwasher



Legumbreira

Legumiere · Servierschüssel
Vegetable dish · Legumeira

| Ref | € | Ø (cm) | L | U.Venta |
|-------|-------|--------|-----|---------|
| 60812 | 25,50 | 22 | 2,0 | 1 |
| 60814 | 28,60 | 24 | 3,0 | 1 |
| 60818 | 37,60 | 28 | 4,5 | 1 |



Sopera con base

Soupiere sur pied · Suppenschüssel mit Fussreif
Soup-tureen with base · Sopeira com base

| Ref | € | Ø (cm) | L | U.Venta |
|-------|-------|--------|------|---------|
| 60823 | 32,80 | 22 | 2,00 | 1 |
| 60825 | 35,00 | 24 | 2,50 | 1 |
| 60829 | 43,10 | 28 | 4,00 | 1 |



Tapa sopera

Couvercle soupiere · Deckel für Servierschüssel
Soup-tureen lid · Tampa sopeira

| Ref | € | Ø (cm) | U.Venta |
|-------|-------|--------|---------|
| 60922 | 20,70 | 22 | 1 |
| 60924 | 23,00 | 24 | 1 |
| 60928 | 27,00 | 28 | 1 |



ASA
Acrylic



INOX

Ensaladera redonda

Saladier ronde · Salatschüssel, rund
Round salad bowl · Bacia de salada redonda

| Ref | € | Ø (cm) | L | U.Venta |
|-------|-------|--------|-----|---------|
| 62394 | 12,70 | 25 | 4,0 | 1 |



6 boles pequenos

6 petit bols · 6 Schüsseln, klein
Vegetable bowls set of 6 · 6 bacias pequenas

| Ref | € | Ø (cm) | ml | U.Venta |
|-------|-------|--------|-----|---------|
| 14012 | 11,60 | 12 | 325 | 1 |



Salsera Luxe con cuchara

Sauciere "Luxe" · Sauciere Luxe
Gravy boat "Luxe" · Molheira "LUXE" com colher

| Ref | € | ml | U.Venta |
|-------|-------|-----|---------|
| 62424 | 24,30 | 200 | 1 |



Salsera Aladino

Sauciere "Aladino" · Sauciere "Aladino"
Gravy boat "Aladino" · Molheira "Aladino"

| Ref | € | cm | ml | U.Venta |
|-------|-------|-------------|-----|---------|
| 61409 | 9,80 | 13x6x8 | 90 | 1 |
| 61415 | 11,70 | 15,5x7,2x10 | 150 | 1 |
| 61424 | 15,80 | 19x8,5x12,5 | 240 | 1 |
| 61430 | 17,00 | 20x9,5x12,5 | 300 | 1 |



Quesera parmesana con cuchara

Boite à fromage a/cuillère · Parmesanmenage mit Löffel
Parmesan bowl with spoon · Queijeira parmesana c/ colher

| Ref | € | Ø (cm) | ml | U.Venta |
|---------|-------|--------|-----|---------|
| 62970 | 32,20 | 9x5 | 200 | 1 |
| * 62971 | 4,20 | - | 200 | 18 |

* Recipiente de cristal · Glass container



Fuente de mantequilla

Beurrier avec couvercle · Butterdose mit Deckel
Butter dish with cover · Manteigueira

| Ref | € | cm | h(cm) | U.Venta |
|-------|-------|-----------|-------|---------|
| 62951 | 14,40 | 11,5x22,5 | 6,5 | 1 |

Área útil de la base:
Base useful area:
15x10,5 cm

BAMBOO VIDRIO
Glass



Recipiente mantequilla

Réceptacle pour le beurre · Butterdose
Butter container · Recipiente para manteiga

| Ref | € | cm | h(cm) | U.Venta |
|-------|-------|---------|-------|---------|
| 62898 | 10,10 | 18,5x14 | 6,5 | 1 |



PP
Polypropylene

RUBBER WOOD



Recipiente mantequilla PP

Réceptacle pour le beurre · Butterdose
Butter container · Recipiente para manteiga

| Ref | € | cm | h(cm) | U.Venta |
|-------|-------|-----------|-------|---------|
| 62899 | 15,40 | 16,5x11,5 | 6,5 | 1 |



Campana cubreplatos Inox
Cloche couvre plat · Tellerglocke
Plate Cover · Campânula cobre-pratos

| Ref | € | Ø (cm) | h(cm) | U.Venta |
|-------|-------|--------|-------|---------|
| 69024 | 26,30 | 24 | 11,0 | 1 |
| 69029 | 39,50 | 28 | 17,5 | 1 |



Campana cubreplatos
Cloche couvre plat · Tellerglocke
Plate Cover · Campânula cobre-pratos

| Ref | € | Ø (cm) | h(cm) | U.Venta |
|-------|-------|--------|-------|---------|
| 61806 | 40,50 | 25 | 18,5 | 1 |
| 61809 | 46,30 | 29 | 20,3 | 1 |
| 61802 | 50,10 | 33 | 22,3 | 1 |



Campana cubreplatos PS
Cloche couvre plat · Tellerglocke
Plate Cover · Campânula cobre-pratos

| Ref | € | Ø (cm) | h(cm) | U.Venta |
|-------|-------|--------|-------|---------|
| 61801 | 6,70 | 22,0 | 12,0 | 1 |
| 61803 | 12,40 | 30,0 | 15,5 | 1 |



Servilletero
Distributeur de serviettes · Serviettenspender
Napkin holder · Guardanapo

| Ref | € | cm | h(cm) | U.Venta |
|-------|-------|-------|-------|---------|
| 61004 | 13,90 | 18x19 | 5,0 | 1 |

INOX

Servilletero bar
Distributeur de serviettes bar · Serviettenspender bar
Bar napkin holder · Guardanapo bar

| Ref | € | cm | Medidas Servilleta | U.Venta |
|-------|------|----------|--------------------|---------|
| 61002 | 9,70 | 9,5x13,5 | 90x125 | 4 |



ASA
Acrylic
Oven Dishwasher
BPA free

Cubre quesos/tartas
Couvre fromage/gâteau · Tellerabdeckung
Cheese/cake cover · Cloque para queijo/tartes

| Ref | € | Ø (cm) | U.Venta |
|-------|-------|--------|---------|
| 62380 | 55,10 | 32 | 1 |

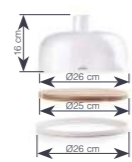

AS
Plastic
BPA free

Quesera
Plateau à fromage avec cloche · Käseglocke
Cheese dome · Queijeira

| Ref | € | U.Venta |
|-------|-------|---------|
| 62404 | 29,80 | 1 |



AS
Plastic
BPA free

Quesera Keep
Plateau à fromage avec cloche · Käseglocke
Cheese dome · Queijeira

| Ref | € | cm | h(cm) | U.Venta |
|-------|-------|-----------|-------|---------|
| 62004 | 26,00 | 28,5x18,5 | 10 | 1 |

INOX



Campanilla de recepción
Sonnnette de réception · Rezeptionsklingel
Reception call bell · Campainha de receção

| Ref | € | Ø (cm) | U.Venta |
|-------|-------|--------|---------|
| 61025 | 11,60 | 10 | 1 |



Papelera sobremesa
Poubelle de table · Tish-Abfallbehälter
Table bin · Papeleira de mesa

| Ref | € | Ø (cm) | h(cm) | L | U.Venta |
|-------|-------|--------|-------|------|---------|
| 63302 | 24,80 | 12 | 16 | 1,20 | 1 |



Azucarero sobremesa
Sucrier de table sphérique · Zuckerdose, Kugelförmig
Spherical table sugar bowl · Açucareiro de mesa esférico

| Ref | € | Ø (cm) | ml | U.Venta |
|-------|-------|--------|-----|---------|
| 63304 | 17,40 | 14 | 600 | 1 |



Pinza sujeta manteles (4pcs.)
Pince à nappe · Tischtuchklammer
Tablecloths pegs · Pinça para toalhas de mesa

| Ref | € | U.Venta |
|-------|------|---------|
| 61023 | 7,10 | 6 |

INOX

Número de mesa
Numéros de table · Tischnummernschild
Table numbers · Números para tabela

| Ref | € | cm | Números | U.Venta |
|-------|-------|-----|---------|---------|
| 61095 | 20,50 | 6x5 | 1-12 | 1 |
| 61096 | 20,50 | 6x5 | 13-24 | 1 |
| 61097 | 20,40 | 6x5 | 25-36 | 1 |

INOX

Indicador reservado
Indicateur réservé · Reserviert-Aufsteller
Reserved signal · Indicador reservado

| Ref | € | cm | U.Venta |
|-------|------|------|---------|
| 61098 | 4,40 | 5x12 | 6 |



Soporte menú con pinza
Support menu à pince · Menükartenhalter
Menu card holder · Suporte menú com pinça

| Ref | € | h(cm) | U.Venta |
|-------|-------|-------|---------|
| 61008 | 13,20 | 20,0 | 1 |
| 61012 | 14,80 | 30,0 | 1 |



INOX

Cepillo recogemigas
Ramasse-miettes à rouleaux · Krümelbürste
Crumbs cleaner · Escova apanha-migalhas

| Ref | € | cm | h(cm) | U.Venta |
|-------|-------|----------|-------|---------|
| 64407 | 15,10 | 9,5x16,5 | 4,0 | 1 |



Cepillo recogedor Hiperluxe
Ramasse-miettes à rouleaux · Krümelbürste
Crumbs cleaner · Escova apanha-migalhas

| Ref | € | cm | U.Venta |
|-------|-------|---------|---------|
| 64408 | 51,10 | 14,5x17 | 1 |

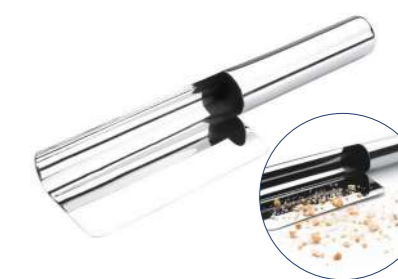

Cepillo recogedor Luxe
Ramasse-miettes · Krümelbürste
Crumbs cleaner · Espátula apanha-migalhas

| Ref | € | cm | U.Venta |
|-------|-------|------|---------|
| 64409 | 31,70 | 22x7 | 1 |



Bandeja con pinza para notas
Porte addition à pince · Platte mit Klemmvorrichtung
Bill holder · Bandeja com pinça para notas

| Ref | € | cm | U.Venta |
|---------|------|---------|---------|
| A 68007 | 5,40 | 11x15,2 | 12 |
| B 68017 | 6,40 | 12x21,5 | 12 |

PP ABS
Polypropylene Plastic

Bandeja cambios Coin
Coupelle ramasse monnaie · Wechselgeldablagen
Changetray · Bandeja para trocos

| Ref | € | Ø (cm) | U.Venta |
|-------|------|--------|---------|
| 68720 | 3,20 | 13 | 12 |



Cenicero
Cendrier · Aschenbecher
Ashtray · Cinzeiro

| Ref | € | Ø (cm) | U.Venta |
|---------|------|--------|---------|
| A 14013 | 2,80 | 14 | 12 |
| A 14065 | 3,20 | 16 | 12 |
| B 62941 | 6,40 | 14 | 1 |

Encendedores



new

- Encendedor de gas flexible y recargable.
- Ideal para las cocinas de gas, chimeneas o barbacoas.
- Regulador de llama. Sistema de bloqueo de seguridad.
- Ranura transparente, para controlar el nivel de carga.
- Protector anti viento.

- Flexible and refillable gas lighter.
- Ideal for gas cookers, fireplaces or barbecues.
- Flame regulator.
- Safety locking system.
- Transparent slot, to control the charge level.
- Anti-wind protector.



Llama · Flame

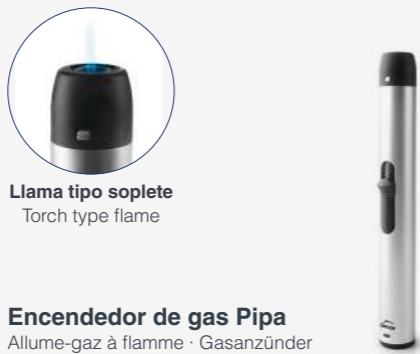

Llama tipo soplete
Torch type flame

Encendedor de gas Flex

Allume-gaz à flamme · Gasanzünder
Gas lighter · Isqueiro de gás

| Ref | € | Largo (cm) | U.Venta |
|-------|------|------------|---------|
| 68966 | 2,40 | 23,5 | 1 |

Encendedor de gas Pipa

Allume-gaz à flamme · Gasanzünder
Gas lighter · Isqueiro de gás

| Ref | € | Largo (cm) | U.Venta |
|-------|------|------------|---------|
| 68967 | 3,40 | 16,0 | 1 |

- Encendedor eléctrico. Recargable con cable USB.
- Ideal para las cocinas de gas, barbacoas, etc.
- Funciona mediante una chispa entre los dos electrodos que hará encender el gas o las mechas.
- Indicador LED de nivel de carga.
- Autonomía: 50 usos con una sola carga.

- Electric lighter. Rechargeable with USB cable
- Ideal for gas cookers, barbecues, etc.
- It works by means of a spark between the two electrodes that will ignite the gas or wicks.
- LED charge level indicator.
- Autonomy: 50 uses on a single charge.



Impulsos eléctricos
Electrical impulses

Encendedor de gas Chip

Allumeur électrique · Elektrisches Küchenfeuerzeug
Electric lighter · Isqueiro elétrico

| Ref | € | Largo (cm) | U.Venta |
|-------|-------|------------|---------|
| 68959 | 11,70 | 18 | 1 |



Encendedores de gas Spark

Allume-gaz à flamme · Gasanzünder
Gas lighter · Isqueiro de gás

| Ref | € | Largo (cm) | U.Venta |
|-------|------|------------|---------|
| 68987 | 4,10 | 27 | 6 |



Encendedor de gas Fixed

Allume-gaz à flamme · Gasanzünder
Gas lighter · Isqueiro de gás

| Ref | € | Largo (cm) | U.Venta |
|-------|------|------------|---------|
| 68978 | 3,60 | 27 | 12 |



Encendedor de gas Bend

Allume-gaz à flamme · Gasanzünder
Gas lighter · Isqueiro de gás

| Ref | € | Largo (cm) | U.Venta |
|-------|------|------------|---------|
| 68979 | 4,40 | 27 | 12 |

Caña flexible
Flexible rod

Caja encendedor de gas Fixed

Allume-gaz à flamme · Gasanzünder
Gas lighter · Isqueiro de gás

| Ref | € | Piezas | U.Venta |
|-------|-------|--------|---------|
| 68976 | 37,80 | 12 | 1 |



Caja encendedores de gas Bend

Allume-gaz à flamme · Gasanzünder
Gas lighter · Isqueiro de gás

| Ref | € | Piezas | U.Venta |
|-------|-------|--------|---------|
| 68977 | 48,50 | 12 | 1 |



Fondue collection

- Fondue eléctrica acabada en acero inoxidable de gran calidad.
- Ideal para fundir queso, chocolate o calentar aceite.
- Olla de acero inoxidable desmontable y de 1,2 L de capacidad con fondo termodifusor para una distribución uniforme del calor.
- Termostato regulable para calentar y mantener los ingredientes siempre calientes.
- Protector antisalpicaduras extraíble con soporte para 8 tenedores.
- Incluye 8 tenedores de acero inoxidable y marcas de colores.
- Apagado de seguridad contra sobrecalentamiento.
- Pies antideslizantes. 100% estable.
- Olla, protector y tenedores aptos para el lavavajillas.

- High quality stainless steel electric fondue set.
- Ideal for melting cheese, chocolate or heating oil.
- 1.2 L removable stainless steel pot with thermo-diffuser bottom for even heat distribution.
- Adjustable thermostat to heat and keep the ingredients hot at all times.
- Removable splash guard lid that holds 8 forks.
- Includes 8 stainless steel colour marked forks.
- Overheating safety function.
- Non-slip feet. 100% stable.
- Dishwasher safe pot, lid and forks.



- Fabricada en hierro fundido esmaltado de máxima calidad. Interior y exterior esmaltado que garantiza una distribución del calor uniforme sin puntos de sobrecalentamiento.
- No absorbe la humedad, los sabores, ni los olores de los alimentos.
- Diseñada para preparar deliciosas fondues de chocolate, queso, verduras, carne, etc.
- Cuenta con protección contra las salpicaduras, soporte de hierro colado y base de madera para mayor estabilidad. Además, incluye quemador de gel combustible (gel no incluido).
- La olla tiene 16,5 cm de diámetro y una capacidad de 1,2 L.
- Apta para todas las fuentes de calor, incluida la inducción.

- Manufactured in molten Iron enameled of the highest quality. Interior and outdoor enameled that guarantees a distribution of uniform heat without overheating points.
- It does not absorb moisture, flavors, nor the smells of food.
- Designed to prepare delicious chocolate fondues, cheese, vegetables, meat, etc.
- It has protection against splashes, cast iron support and wood base for greater stability. In addition, it includes fuel gel burner (gel not included).
- The pot is 16.5 cm in diameter and a capacity of 1.2 L.
- Suitable for all heat sources, including induction.



INOX 18/10 CE

Fondue Grey Plus

Fondue · Fondue
Fondue · Fonduel

| Ref | € | W | Temperatura | L | U.Venta |
|-------|--------|------|-------------|------|---------|
| 69399 | 101,90 | 1500 | 40°C - 95°C | 1,20 | 1 |



FE FUNDIDO
Iron Cast
Dishwasher

Fondue Rosso

Fondue · Fondue
Fondue · Fonduel

| Ref | € | L | U.Venta |
|-------|-------|------|---------|
| 71711 | 63,90 | 1,20 | 1 |



Gel combustible Etanol

Gel chauffe ETHANOL · Brennpaste, ETHALKOHOL
Fuel gel, ETHANOL · Gel combustible ETANOL

| | Ref | € | Peso (Kg) | Horas | U.Venta |
|---|-------|-------|-----------|--------|---------|
| A | 71780 | 4,90 | 0,08 | 80 min | 1 |
| B | 69108 | 2,80 | 0,225 | 3 | 72 |
| C | 69107 | 8,80 | 0,840 | - | 1 |
| D | 69109 | 40,50 | 4,00 | - | 1 |



Aliño

INOX  Dishwasher



Juego vinagrera Basic
Set vinaigrie · Menage
Cruet set · Jogo galheteiro

| Ref | € | ml | U.Venta |
|-------|-------|----------|---------|
| 62864 | 14,30 | 175-37,5 | 1 |



Juego aceitera-vinagrera Basic
Set huilier et vinaigries · Öl-Essig-Set
Oil-vinegar set · Jogo azeiteira-galheteiro

| Ref | € | ml | U.Venta |
|-------|-------|-----|---------|
| 62862 | 11,40 | 175 | 1 |



Juego salero-pimentero Basic
Set calière et poivriere · Satz-Pfeffer-Set
Salt-pepper set · Jogo saleiro-pimenteiro

| Ref | € | ml | U.Venta |
|-------|------|------|---------|
| 62866 | 5,90 | 37,5 | 6 |



Juego salero-pimentero-mostaza Basic
Set 3 pièces sel poivre moutarde · Salz/Pfeffer/Senf-Set
Salt-pepper-mustard set · Saleiro-pimenteiro-mostarda set

| Ref | € | ml | U.Venta |
|-------|------|----------|---------|
| 62867 | 9,40 | 37,5-150 | 1 |



INOX 18/10

Aceitera cónica
Huilier · Ölkanne
Oil can · Azeiteira cónica

| Ref | € | h(cm) | L | U.Venta |
|-------|-------|-------|------|---------|
| 62525 | 28,80 | 10,0 | 0,25 | 1 |
| 62555 | 42,20 | 19,0 | 0,50 | 1 |
| 62551 | 51,90 | 23,0 | 1,00 | 1 |



Dosificador-medidor de aceite
Doseur distributeur à huile · Öl-Dosierer mit Massanzeige
Oil portionner-measurer · Distribuidor-manómetro de óleo

| Ref | € | Ø (cm) | ml | U.Venta |
|-------|-------|--------|-----|---------|
| 62252 | 22,70 | 7,8x23 | 250 | 1 |



PC Polycarbonate 

Pulverizador de aceite
Pulvérisateur d'huile · Öl-Spray
Oil Sprayer · Pulverizador de azeite

| Ref | € | Ø (cm) | ml | U.Venta |
|-------|-------|--------|-----|---------|
| 61908 | 15,80 | 7x18 | 100 | 1 |



ASA Acrylic 

Pulverizador de aceite-vinagre
Pulvérisateur d'huile et vinaigries · Öl-Essig Spray
Oil-vinager bottle spray · Pulverizador de azeite-galheteiro

| Ref | € | Ø (cm) | ml | U.Venta |
|-------|-------|--------|-----|---------|
| 61921 | 16,50 | 5,5x20 | 200 | 1 |



Filtro resistente al calor
Heat-resistant filter

PS Plastic 

Jarra separadora grasas
Separateur de graisse · Fettabscheider
Gravy/fat separator · Separador de gorduras

| Ref | € | ml | Unidad | U.Venta |
|-------|------|-----|-----------|---------|
| 61610 | 7,30 | 500 | ml-oz-cup | 4 |

Especieros

INOX 



Especiero agujeros Inox
Saupoudreuse à figures · Gewürzdose/Streuer, Lochung
Shaker plastic cover hole lid · Polvilhador burucos

| Ref | € | Ø (cm) | h (cm) | U.Venta |
|---------|------|--------|--------|---------|
| A 62906 | 8,90 | 7 | 9,5 | 12 |
| B 62905 | 8,90 | 7 | 9,5 | 12 |



Especiero queso Inox
Saupoudreuse à fromage · Käsestreuert
Cheese shaker · Polvilhadorqueijo ralado

| Ref | € | Ø (cm) | h (cm) | U.Venta |
|-------|------|--------|--------|---------|
| 62904 | 8,70 | 7 | 9,50 | 12 |



Especiero malla Inox
Saupoudreuse à maille · Gewürzdose/Streuer-Fein
Shaker plastic cover fine mesh lid · Polvilhador rede fina

| Ref | € | Ø (cm) | h (cm) | U.Venta |
|-------|------|--------|--------|---------|
| 62903 | 9,40 | 7 | 9,50 | 12 |

PMMA Plastic  INOX 18/10  





Pimentero Clear
Poivrière · Pfefferstreuer
Pepper shaker · Pimenteiro

| Ref | € | Ø (cm) | h (cm) | U.Venta |
|-------|-------|--------|--------|---------|
| 61903 | 10,90 | 7 | 12,5 | 1 |



Especiero queso Clear
Saupoudreuse à fromage · Käsestreuert
Cheese shaker · Polvilhadorqueijo ralado

| Ref | € | Ø (cm) | h (cm) | U.Venta |
|-------|-------|--------|--------|---------|
| 61905 | 10,90 | 7 | 12,5 | 1 |



Salero Clear
Salière · Salzstreuet
Salt shaker · Saleiro

| Ref | € | Ø (cm) | h (cm) | U.Venta |
|-------|-------|--------|--------|---------|
| 61907 | 11,00 | 7 | 12,5 | 1 |



Azucarero Clear
Saupoudreuse à sucre · Zuckerstreuert
Sugar shaker · Acucareiro

| Ref | € | Ø (cm) | h (cm) | U.Venta |
|-------|-------|--------|--------|---------|
| 61904 | 12,30 | 7 | 12,5 | 1 |



Especiero malla Clear
Saupoudreuse à maille fine · Mehlstreuer
Mesh shaker · Polvilhador rede

| Ref | € | Ø (cm) | h (cm) | U.Venta |
|-------|-------|--------|--------|---------|
| 61906 | 11,60 | 7 | 12,5 | 1 |



Dispensador miel Clear
Distributeur de miel · Honigbehälter
Honey dispenser · Dosificador mel

| Ref | € | Ø (cm) | h (cm) | U.Venta |
|-------|-------|--------|--------|---------|
| 61909 | 14,40 | 7 | 12,5 | 1 |

Molinillos



new



- Fabricados en madera de caucho de alta calidad con un revestimiento de esmalte mate natural.
- Muela de cerámica eficaz, de gran durabilidad y resistente a la corrosión.
- Pomo ajustable de molienda fabricado en acero inoxidable.
- Diseño clásico y elegante, dirigidos tanto para el usuario profesional como para el doméstico.
- Ergonómicos y versátiles: aptos para sal, pimienta y otras especias.

- Fabriquée en bois de caoutchouc de haute qualité avec un revêtement en vernis mat naturel.
- Meule en céramique efficace, très durable et résistante à la corrosion.
- Bouton de meulage réglable en acier inoxydable.
- Conception classique et élégante, destinée aux professionnels et aux particuliers.
- Ergonomiques et polyvalent : apte pour le sel, le poivre et d'autres épices.

- Made of high quality rubber wood with a natural matt enamel coating.
- Effective, highly durable and corrosion-resistant ceramic grinding wheel.
- Adjustable grinding knob made of stainless steel.
- Classic and elegant design, suitable for both professional and home users.
- Ergonomic and versatile: suitable for salt, pepper and other spices.

Mecanismo cerámico
Ceramic mechanism

Mecanismo cerámico
Ceramic mechanism

RUBBER WOOD CE INOX
Ceramic

Molinillo Black
Moulin · Manuelle
Grinder · Moinho

| Ref | € | h(cm) | U.Venta |
|-------|-------|-------|---------|
| 64515 | 21,70 | 15 | 1 |
| 64520 | 27,20 | 20 | 1 |
| 64530 | 42,30 | 30 | 1 |



RUBBER WOOD CE INOX
Ceramic

Molinillo Wood
Moulin · Manuelle
Grinder · Moinho

| Ref | € | h(cm) | U.Venta |
|-------|-------|-------|---------|
| 64815 | 18,50 | 15 | 1 |
| 64820 | 23,10 | 20 | 1 |
| 64830 | 37,10 | 30 | 1 |



Mecanismo de acero templado
Hardened steel mechanism

Mecanismo cerámico
Ceramic mechanism

Mecanismo cerámico
Ceramic mechanism

2 in 1

HAYA
Wood

ASA
Acrylic

ASA
Acrylic

Molinillo pimienta
Moulin à Poivre · Pfeffermühle
Pepper Grinder · Moinho de pimenta em madeira

Molinillo de sal-pimienta
Moulin à sel - poivre · Pfeffer / Salz mühle
Salt - pepper Grinder · Moinho de sal - pimenta

Molinillo doble sal-pimienta
Moulin double à sel - poivre · Salz und Pfeffermühle Doppelt
Salt - pepper double grinder · Moinho duplo de sal - pimenta

| Ref | € | Ø (cm) | h(cm) | U.Venta |
|-------|-------|--------|-------|---------|
| 63215 | 27,40 | 5,0 | 15 | 1 |
| 63220 | 32,20 | 5,5 | 20 | 1 |
| 63225 | 38,20 | 6,0 | 25 | 1 |

| Ref | € | h(cm) | U.Venta |
|-------|-------|-------|---------|
| 62814 | 24,10 | 14 | 6 |
| 62818 | 25,10 | 18 | 6 |
| 62823 | 27,10 | 23 | 6 |

| Ref | € | Ø (cm) | h(cm) | U.Venta |
|-------|-------|--------|-------|---------|
| 62816 | 20,00 | 6 | 18 | 1 |



8 niveles de grosor
8 grinding levels

CRISTAL INOX
Glass 18/10

Molinillo manual

Moulin manuel · Manuelle Mühle
Manual grinder · Moinho manual

| Ref | € | Capacidad contenedor | U.Venta |
|-------|-------|----------------------|---------|
| 62817 | 34,10 | 45 g | 1 |



INOX CE BPA free Dishwasher

Molinillo Limu

Moulin à café · Kaffeemühle
Coffe grinder · Moedor de café

| Ref | € | W | Capacidad contenedor | U.Venta |
|-------|-------|-----|----------------------|---------|
| 69385 | 38,20 | 200 | 60 g | 1 |



Mecanismo cerámico
Ceramic mechanism



- Ideal para moler café y otros alimentos como semillas, hierbas, frutos secos, cereales, sal, pimienta o especias.
- Muele al instante. Muelas cerámicas extrafuertes: no pierden filo y no se oxidan.
- Molido a baja velocidad: conserva mejor las propiedades y aromas.
- Funcionamiento sencillo. Muy fácil de limpiar.
- 8 niveles de grosor: obtén la molienda perfecta para ocasión.
- Depósito para 45 g de granos de café molido.

- Ideal for grinding coffee and other foods such as seeds, herbs, nuts, cereals, salt, pepper or spices.
- Move instantly. Extrafuertes ceramic teeth: do not lose edge and do not oxidize.
- Low speed: Better preserves properties and aromas.
- Simple operation. Very easy to clean.
- 8 thickness levels: get the perfect grinding for occasion.
- Deposit for 45 g of ground coffee beans.

- Ideal para moler café y otros productos como semillas, hierbas, frutos secos, cereales, sal, pimienta o especias.
- 100% acero inoxidable: cuerpo y cuchillas fabricados en acero inoxidable de máxima calidad.
- Tapa transparente: tapa superior de color transparente para visualizar el grano molido.
- Interruptor ON/OFF: funcionamiento con un simple botón (inicio/parada).
- Interruptor de seguridad: las cuchillas se activan solo cuando la tapa está correctamente cerrada.
- Depósito para 60 g de granos de café molido. Almacenamiento para el cable.

- Idéal pour le café et d'autres produits tels que les graines, les herbes, les noix, les céréales, le sel, le poivre ou les épices.
- 100% en acier inoxydable: corps et lames en acier inoxydable de qualité maximale.
- Couvercle transparent: couvercle de couleur transparente supérieure pour afficher le grain moulu.
- Interrupteur ON / OFF: Fonctionnement avec un bouton simple (démarrage / arrêt).
- Interrupteur de sécurité: les lames ne sont activées que lorsque le couvercle est correctement fermé.
- Déposez 60 g de grains de café moulus. Stockage du câble.

- Ideal for grinding coffee and other products such as seeds, herbs, nuts, cereals, salt, pepper or spices.
- 100% stainless steel: body and blades made of maximum quality stainless steel.
- Transparent lid: upper transparent color lid to display the ground grain.
- On/off switch: operation with a simple button (start/stop).
- Safety switch: The blades are activated only when the lid is correctly closed.
- Deposit for 60 g of ground coffee beans. Cable storage..



Pinzas

INOX
18/10
Dishwasher



Pinza servicio mesa

Pince à servir · Servierzange
Serving tong · Pinça de serviço de mesa

| Ref | € | Largo (cm) | U.Venta |
|-------|------|------------|---------|
| 62307 | 4,90 | 21 | 12 |



Tenedor - Cucharar servir

Pince à service · Servierzange
Utility tong · Garfo e colher de servir

| Ref | € | Largo (cm) | U.Venta |
|-------|-------|------------|---------|
| 68009 | 10,20 | 24 | 6 |



Cuchara pinza servir

Cuillère pince à service · Servierlöffel, Zange
Serving spoon tong · Concha pinça de servir

| Ref | € | Largo (cm) | U.Venta |
|-------|-------|------------|---------|
| 62353 | 12,50 | 24 | 1 |



Pinza hamburguesa

Pince inox pour hamburger · Zange für Burgers
Tongs for beef Burgers · Pinça de hamburger

| Ref | € | Largo (cm) | U.Venta |
|-------|-------|------------|---------|
| 62318 | 12,20 | 24 | 12 |



Pinza pasta Luxe

Pince à spaghetti · Teigwaren Zange
Pasta Tong · Pinça massas

| Ref | € | Largo (cm) | U.Venta |
|-------|-------|------------|---------|
| 62981 | 10,40 | 20 | 1 |



Pinza pasta

Pince à spaghetti · Teigwaren-Zange
Spaguetti Tong · Pinça massas

| Ref | € | Largo (cm) | U.Venta |
|-------|------|------------|---------|
| 62986 | 5,60 | 19 | 12 |



Pinza pan Small

Pince à pain · Brotzange
Bread tong · Pinça pão

| Ref | € | Largo (cm) | U.Venta |
|-------|------|------------|---------|
| 62978 | 9,00 | 18 | 1 |



Pinza pan Medium

Pince à pain · Brotzange
Bread tong · Pinça pão

| Ref | € | Largo (cm) | U.Venta |
|-------|-------|------------|---------|
| 62982 | 17,40 | 23 | 12 |



Pinza ensalada

Pinces a salade · Salatzege
Salad scissor tong · Pinça de salada

| Ref | € | Largo (cm) | U.Venta |
|-------|------|------------|---------|
| 68021 | 4,90 | 28,5 | 12 |



ASA
Acrylic
BPA free

Tenedor + cuchara ensalada

Fourchette + cuillère a salade · Gabel + Löffel Acryl
Salad spoon + fork · Garfo + colher de salada

| Ref | € | Largo (cm) | U.Venta |
|-------|------|------------|---------|
| 62399 | 7,80 | 30 | 1 |



Pinza repostería

Pince à gateau · Gebäck-Tortenzange
Cake tong · Pinça pastelaria

| Ref | € | Largo (cm) | U.Venta |
|-------|-------|------------|---------|
| 62317 | 12,00 | 20 | 1 |



Pinza repostería con anillas

Pince à gateau avec anneaux · Gebäckzange
Cake tong with rings · Pinça pastelaria com anilhas

| Ref | € | Largo (cm) | U.Venta |
|-------|------|------------|---------|
| 68008 | 6,10 | 16 | 6 |



Pinza para bolsitas de té

Pince pour sachets de thé · Teebeutelzange
Tea bag tong · Pinças para saquetas de chá

| Ref | € | Largo (cm) | U.Venta |
|---------|------|------------|---------|
| A 68078 | 2,40 | 13,5 | 1 |
| B 68079 | 3,60 | 14 | 1 |



Pinza azucarillos

Pince à sucre · Zucker-Zange
Food tong · Pinça p/cubos de açúcar

| Ref | € | Largo (cm) | U.Venta |
|-------|------|------------|---------|
| 62985 | 3,80 | 11 | 6 |



Pinza hielo

Pince à glace · Eiszange
Ice tong · Pinça de gelo

| Ref | € | Largo (cm) | U.Venta |
|-------|------|------------|---------|
| 62306 | 4,70 | 18,5 | 12 |



INOX

Pinza hielo inox

Pince à glace · Eiszange
Ice tong · Pinça de gelo

| Ref | € | Largo (cm) | U.Venta |
|-------|-------|------------|---------|
| 62337 | 10,20 | 20 | 12 |



Pinza multiusos Luxe

Pince multi-usages · Allzweck Zange
Multipurpose tong · Pinça multiusos

| Ref | € | Largo (cm) | U.Venta |
|-------|-------|------------|---------|
| 62334 | 20,30 | 25 | 1 |



INOX

Pinza multiusos

Pince multi-usages · Allzweck-Zange
Luxe tong · Pinça multiusos

| Ref | € | Largo (cm) | U.Venta |
|-------|------|------------|---------|
| 62984 | 3,90 | 16 | 5 |



Pinza Luxe

Pince · Zange
Tong · Pinça

| Ref | € | Largo (cm) | U.Venta |
|-------|-------|------------|---------|
| 62983 | 15,70 | 30 | 12 |



SI
Silicone
BPA free
200°C
Max

Pinza grill Red

Pince à grill · Grillzange
Grill tong · Pinça grelhador

| Ref | € | Largo (cm) | U.Venta |
|-------|------|------------|---------|
| 62931 | 9,20 | 29 | 1 |



INOX

Pinza Jumbo

Pince de service · Zange
Utility tong · Pinça

| Ref | € | Largo (cm) | U.Venta |
|-------|------|------------|---------|
| 62924 | 5,90 | 24 | 12 |
| 62930 | 6,90 | 30 | 12 |
| 62940 | 8,10 | 40 | 12 |

INOX PA
Nylon



Pinza Jumbo Nylon
Pince de service · Zange
Utility tong · Pinça

| Ref | € | Largo (cm) | U.Venta |
|-------|-------|------------|---------|
| 62926 | 7,60 | 24 | 12 |
| 62929 | 8,80 | 30 | 12 |
| 62939 | 11,40 | 40 | 12 |

INOX SI
Silicone



Pinza Jumbo Silicona
Pince de service · Zange
Utility tong · Pinça

| Ref | € | Largo (cm) | U.Venta |
|-------|-------|------------|---------|
| 63926 | 7,60 | 24 | 12 |
| 63929 | 8,80 | 30 | 12 |
| 63939 | 11,40 | 40 | 12 |

2 in 1



INOX 18/10

PP Polypropylene

PA Nylon



Pinza Duplo
Pince · Zange
Tong · Pinça

| Ref | € | Largo (cm) | U.Venta |
|-------|-------|------------|---------|
| 63049 | 11,90 | 30 | 1 |

Pinza quitaespinas

Pince à arêtes · Grätzenzange
Fish-bone tweezers · Pinça tira-espinhas

| Ref | € | Largo (cm) | U.Venta |
|-------|------|------------|---------|
| 62938 | 4,80 | 8 | 1 |
| 62928 | 6,10 | 12 | 1 |



Pinza quitaespinas fish

Pince à arêtes · Grätzenzange
Fish-bone tweezers · Pinça tira-espinhas

| Ref | € | Largo (cm) | U.Venta |
|-------|------|------------|---------|
| 62879 | 4,80 | 13 | 1 |



INOX SI
Silicone

Pinzas Silicona

Pinces silicon · Silikon Zanges
Silicone tongs · Pinças silicone

| Ref | € | Largo (cm) | U.Venta |
|---------|-------|------------|---------|
| A 64434 | 69,30 | 18,0 | 1 |
| B 64432 | 3,00 | 18,0 | 12 |
| C 64433 | 3,00 | 18,0 | 12 |
| D 64436 | 3,00 | 18,0 | 12 |
| E 64437 | 3,00 | 18,0 | 12 |
| F 64439 | 3,00 | 18,0 | 12 |



INOX BPA free

Pinzas Karu
Pinces · Zanges
Tongs · Pinças

| Ref | € | Largo (cm) | Ref | € | Largo (cm) | U.Venta |
|---------|------|------------|-------|------|------------|---------|
| A 63060 | 7,50 | 24 | 63070 | 8,10 | 30 | 12 |
| B 63061 | 7,50 | 24 | 63071 | 8,10 | 30 | 12 |
| C 63062 | 7,50 | 24 | 63072 | 8,10 | 30 | 12 |
| D 63063 | 7,50 | 24 | 63073 | 8,10 | 30 | 12 |
| E 63064 | 7,50 | 24 | 63074 | 8,10 | 30 | 12 |
| F 63065 | 7,50 | 24 | 63075 | 8,10 | 30 | 12 |

Mango revestido con una capa de aislante térmica para una mejor sujeción.
Handle coated with a layer of thermal insulation and an enhanced grip.



Pinzas de precisión

INOX 18/10
Dishwasher

- Pinza de precisión fabricada en acero inoxidable 18/10 de máxima calidad.
- Ideal para manipular y emplatar tus creaciones a la perfección.
- Mango antideslizante y puntas acanaladas para una sujeción 100% segura.
- Apta para el lavavajillas.

- Pince de précision en acier inoxydable 18/10 de qualité maximale.
- Idéal pour manipuler et placer parfaitement vos créations.
- Mango sans glissement et conseils châtés pour un soutien à 100% sûr.
- Convient au lave-vaisselle.

- Precision clamp made of stainless steel 18/10 of maximum quality.
- Ideal to manipulate and place your creations perfectly.
- Non-slip mango and chasted tips for 100% safe support.
- Suitable for dishwasher.

Puntas curvas puntiagudas y rugosas
Curved tipspointed and rough



Pinza de precisión recta

Pince à grill · Grilltange
Grill tong · Pinça grelhador

| Ref | € | Largo (cm) | U.Venta |
|-------|-------|------------|---------|
| 62955 | 5,40 | 15,5 | 1 |
| 62956 | 10,60 | 21,0 | 1 |
| 62933 | 15,40 | 30,0 | 6 |

Pinza de precisión acodada

Pince de précision · Präzision zange
Precision tong · Pinça de precisão

| Ref | € | Largo (cm) | U.Venta |
|-------|------|------------|---------|
| 62865 | 4,80 | 15,5 | 1 |

Pinza de precisión Inox

Pince de précision · Präzision zange
Precision tong · Pinça de precisão

| Ref | € | Largo (cm) | U.Venta |
|-------|------|------------|---------|
| 62954 | 5,40 | 16 | 1 |
| 62821 | 6,40 | 21 | 1 |

Acabado negro mate
Finish in matte black



Acabado iridiscente
Iridescent finish



Pinza de precisión Titan Black

Pince de précision · Präzision zange
Precision tong · Pinça de precisão

| Ref | € | Largo (cm) | U.Venta |
|-------|------|------------|---------|
| 62874 | 4,60 | 16 | 1 |
| 62872 | 6,10 | 21 | 1 |

Pinza de precisión Titan Rainbow

Pince de précision · Präzision zange
Precision tong · Pinça de precisão

| Ref | € | Largo (cm) | U.Venta |
|-------|------|------------|---------|
| 62875 | 4,60 | 16 | 1 |
| 62873 | 6,10 | 21 | 1 |



Pinza de precisión con cuchara

Pince de précision a/cuillère · Präzision zange m/Löffel
Precision tong with spoon · Pinça de precisão c/colher

| Ref | € | Largo (cm) | U.Venta |
|-------|------|------------|---------|
| 62863 | 6,00 | 17,0 | 1 |

Utensilios cocina

INOX
18/10



ZAMAK
Zinc Alloy

Tenaza extractor huesos aceitunas

Dénoyateur, Chromé · Olivenentsteiner, Verchromt
Zinc alloy live seed remover · Tenaz extractor de ossos de azeitonas

| Ref | € | Largo (cm) | U.Venta |
|-------|------|------------|---------|
| 62973 | 8,20 | 16 | 1 |

Cuchara para miel

Cuillère à miel · Honiglöffel aus Edelstahl
St steel honey spoon · Colher para mel

| Ref | € | Largo (cm) | U.Venta |
|-------|-------|------------|---------|
| 61361 | 10,90 | 16,5 | 1 |



Cascanueces Wood

Casse Noix · Nussknacker
Nut Cracker · Parte-nozes

| Ref | € | U.Venta |
|-------|------|---------|
| 63059 | 8,20 | 1 |



- Fabricado en aleación de aluminio y mango de madera de acacia de gran calidad.
- Muelle de alta resistencia. Gracias a su diseño de alicate, la parte interior de la nuez no se rompe.
- 2 en 1: cascanueces y abridor de botellas.
- Mango ergonómico: fácil uso y sin apenas esfuerzo.
- Gran durabilidad.

new

- Fabriquè en alliage d'aluminium et manche en bois d'acacia de grande qualité.
- Ressort hautement résistant. Grâce à sa conception en forme de tenailles, la partie intérieure de la noix ne se casse pas.
- 2 en 1 : casse-noix et ouvre-bouteilles.
- Manche ergonomique : utilisation simple et sans à peine d'efforts.
- Grande durabilité.
- Made of aluminium alloy with a high quality acacia wood handle.
- High resistance spring. The plier-like design prevents the kernel of the nut from breaking.
- 2 in 1: nutcracker and bottle opener.
- Ergonomic handle: easy and almost effortless to use.
- Long-lasting durability.

ZAMAK
Zinc Alloy

Cascanueces Basic

Casse Noix · Nussknacker
Nut Cracker · Parte-nozes

| Ref | € | Largo (cm) | U.Venta |
|-------|-------|------------|---------|
| 63016 | 15,80 | 17 | 6 |



ZAMAK
Zinc Alloy

Cascanueces

Casse Noix · Nussknacker
Nut Cracker · Parte-nozes

| Ref | € | U.Venta |
|-------|-------|---------|
| 63017 | 19,80 | 6 |



3 in 1

INOX

Tenaza marisco

Pince à casse-homard · Hummerzange
Lobster cracker · Tenaz mariscos

| Ref | € | Largo (cm) | U.Venta |
|-------|-------|------------|---------|
| 62908 | 15,90 | 16 | 12 |



INOX

Tijera-tenaza marisco

Pince casse homard · Schere/Zange Meeresfrüchte
Sea food scissor-tong · Tesoura-tenaz marisco

| Ref | € | Largo (cm) | U.Venta |
|-------|-------|------------|---------|
| 62974 | 17,60 | 18,5 | 12 |



Abre ostras Luxe

Couteau à huîtres · Austermesser
Oyster opener · Aberto-ostras

| Ref | € | Largo (cm) | U.Venta |
|-------|-------|------------|---------|
| 62684 | 12,90 | 20 | 1 |



INOX

Pinchos para marisco

Curettes à homard · Hummergabel
Seafood forks · Espetos para marisco

| Ref | € | Largo (cm) | U.Venta |
|-------|-------|------------|---------|
| 62976 | 30,70 | 20,0 | 1 |

6
units



INOX

Desescamador de pescado Mini

Grattoir de poissons · Fischeschuppenentferner
Fish scraper · Raspador de peixe

| Ref | € | Largo (cm) | U.Venta |
|-------|------|------------|---------|
| 39040 | 8,40 | 19 | 1 |



Doble hojas dentadas

Double toothed slats

Las escamas se quedan atrapadas en la funda
The scales get trapped in the cover

INOX
18/10

SI
Silicone

Desescamador de pescado Safe

Grattoir de poissons · Fischeschuppenentferner
Fish scraper · Raspador de peixe

| Ref | € | Largo (cm) | U.Venta |
|---------|-------|------------|---------|
| 39042 | 24,70 | 30 | 1 |
| R39042A | 8,10 | 14 | 1 |



Manteles y salvamanteles

Tablecloths and placemats



Manteles de mesa



- Fabricado en cuero 100% reciclado. Espesor de 1,5 y 2,1 mm.
- Resistente a altas temperaturas y manchas. Aislante del calor. Impermeable.
- Perfecto para vestir y proteger las mesas de restaurantes, cafeterías y hasta el propio hogar.

- Fabriqué en cuir 100% recyclé. 1,5 et 2,1 mm d'épaisseur.
- Résistant aux températures et taches élevées. Isolateur de chaleur. Imperméable.
- Parfait pour s'habiller et protéger les tables des restaurants, des cafés et même de la maison.

- Made of 100% recycled leather. 1.5 and 2.1 mm thickness.
- Resistant to high temperatures and spots. Heat insulator. Raincoat.
- Perfect to dress and protect the tables of restaurants, coffee shops and even home.



Mantel individual Oval

Nappe individuelle ovale · Tischset, oval
Oval individual placemat · Toalhas de mesa individual oval

| Ref | € | cm | e (mm) | U.Venta |
|----------------|-------|-------|--------|---------|
| A 66845 | 20,40 | 45x35 | 1,6 | 1 |
| B 66846 | 20,40 | 45x35 | 1,6 | 1 |
| C 66847 | 20,40 | 45x35 | 1,6 | 1 |
| D 66839 | 20,40 | 45x35 | 1,5 | 1 |
| E 66840 | 20,40 | 45x35 | 1,5 | 1 |
| F 66841 | 21,30 | 45x35 | 2,1 | 1 |
| G 66842 | 21,30 | 45x35 | 2,1 | 1 |

- SAURA
- BOSCO
- SIMONE
- MILOS
- CRETA
- RINIA
- COS

Mantel individual rectangular

Nappe individual rectangulaire · Tischset, rechteckiger
Rectangular individual placemat · Toalhas de mesa individual rectangular

| | Ref | € | cm | e (mm) | U.Venta | |
|----------|-------|-------|-------|--------|---------|-------|
| A | 66831 | 18,80 | 45x30 | 1,5 | 1 | MILOS |
| B | 66834 | 19,50 | 45x30 | 2,1 | 1 | COS |

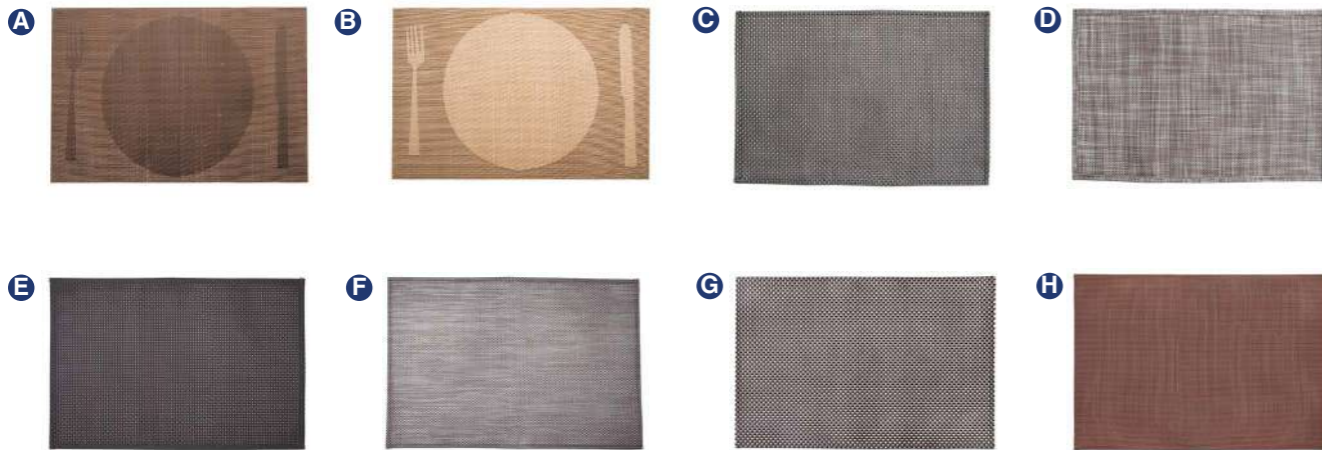

Mantel individual Home

Nappe individuel · Tischset
Individual placemat · Toalha de mesa individual

| | Ref | € | cm | U.Venta | |
|----------|-------|------|-------|---------|-------|
| A | 66756 | 4,40 | 45x30 | 6 | KRABI |
| B | 66757 | 4,40 | 45x30 | 6 | TAPU |
| C | 66772 | 4,90 | 45x30 | 6 | LANTA |
| D | 66773 | 4,90 | 45x30 | 6 | KOTAO |
| E | 66780 | 4,80 | 45x30 | 6 | SUMBA |
| F | 66781 | 4,80 | 45x30 | 6 | BIAK |
| G | 66782 | 4,80 | 45x30 | 6 | GILI |
| H | 66783 | 4,80 | 45x30 | 6 | RINCA |



PVC
Plastic

PVC
Plastic

Mantel individual Aura

Nappe individuel · Tischset
Individual placemat · Toalha de mesa individual

| | Ref | € | cm | U.Venta | |
|----------|-------|------|-------|---------|---------|
| A | 66784 | 7,10 | 45x30 | 6 | MASBATE |
| B | 66785 | 7,10 | 45x30 | 6 | LEYTE |

Mantel individual Wood

Nappe individuel · Tischset
Individual placemat · Toalha de mesa individual

| | Ref | € | cm | U.Venta | |
|----------|-------|------|-------|---------|-------|
| A | 66787 | 7,10 | 45x30 | 6 | DAVAO |
| B | 66788 | 7,10 | 45x30 | 6 | TICAO |

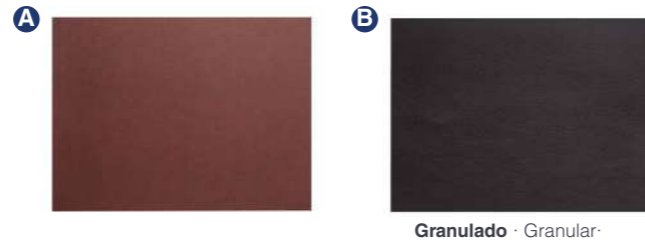

Granulado · Granular

Salvamanteles



- **Salvamantel magnético fabricado en roble de máxima calidad, muy agradable al tacto (63041).**
- **Salvamantel magnético fabricado en silicona de máxima calidad (63042).**
- **Diseñado para apoyar y transportar sartenes, ollas, cacerolas, etc. de forma cómoda y segura, sin riesgo a quemarse.**
- **Superresistente a altas temperaturas. Protege las superficies y las encimeras.**
- **No es apto para el lavavajillas.**

- Dessous de plat magnétique fabriqué en chêne de la plus grande qualité, très agréable au toucher (63041).
- Dessous de plat magnétique fabriqué en en silicone de qualité supérieure (63042).
- Conçu pour transporter et y poser des poêles, des casseroles, des faitouts, etc. de façon pratique et sûre, sans risquer de se brûler.
- Très résistant aux hautes températures. Protège les surfaces et les plans de travail.

- Ne peut pas être mis au lave-vaisselle.
- Magnetic trivet made of top quality oak with a very nice feel (63041).
- Magnetic trivet made of top quality silicone (63042).
- Designed to hold and move frying pans, pots, casseroles etc. safely and conveniently without risk of getting burned.
- Extremely resistant to high temperatures. Protects surfaces and counter tops.
- Not dishwasher safe.



ROBLE
Oak

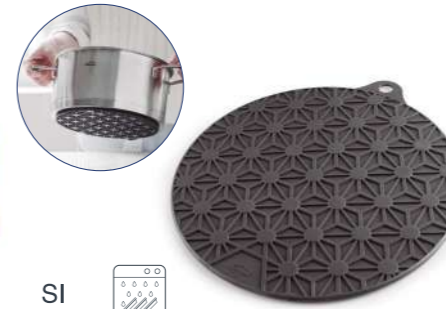

SI
Silicone
Dishwasher



SI
Silicone
Dishwasher

Salvamanteles magnético

Dessous de plat magnétique · Untersetzer, magnetisch
Magnetic trivet · Base para tachos magnética

| Ref | € | cm | U.Venta |
|-------|-------|-------|---------|
| 63041 | 21,80 | 23x20 | 1 |

Salvamanteles magnético Grip

Dessous de plat magnétique · Untersetzer, magnetisch
Magnetic trivet · Base para tachos magnética

| Ref | € | Ø (cm) | U.Venta |
|-------|------|--------|---------|
| 63042 | 8,50 | 20 | 1 |

Salvamanteles Unite

Dessous de plat · Untersetzer
Trivet protector · Protector de toalhas

| Ref | € | cm | U.Venta |
|-------|------|-------|---------|
| 63043 | 4,20 | 16x16 | 1 |

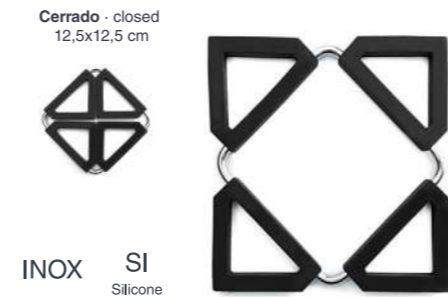

INOX
SI
Silicone



INOX
18/10



INOX

Salvamanteles desplegable

Dessous de plats dépliant · Untersatz
Trivet foldable · Protector de toalhas dobrável

| Ref | € | cm | U.Venta |
|-------|-------|-------|---------|
| 66752 | 11,40 | 16x16 | 1 |

FE
Iron

Salvamanteles

Dessous de plats · Untersatz
Trivet protector · Protector de toalhas

| Ref | € | cm | U.Venta |
|-------|-------|-------|---------|
| 63008 | 18,90 | 23x23 | 1 |

Salvamanteles Black

Dessous de plats · Untersatz
Trivet protector · Protector de toalhas

| | Ref | € | cm | Varilla (mm) | U.Venta |
|----------|-------|-------|-----------|--------------|---------|
| A | 61129 | 13,70 | 18,5x18,5 | 5x3 | 1 |
| | 61130 | 17,80 | 25x25 | 5x3 | 1 |
| | 61131 | 17,80 | 30x20 | 5x3 | 1 |
| B | 61132 | 24,30 | 40x25 | 5x3 | 1 |

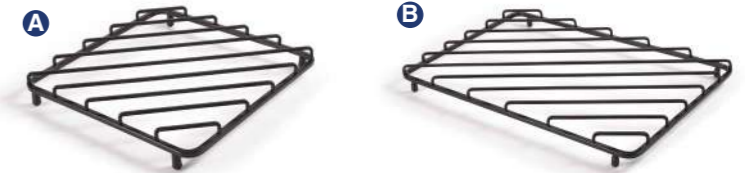

Termos y botellas

Thermos and bottles



Jarras termo



- Jarras termo que mantienen los líquidos calientes y fríos durante horas.
- Ideales para servir café, leche o té.
- Cuerpo de polipropileno, ligero y muy cómodo.
- Doble pared con una capa de vidrio en el interior que proporciona un alto rendimiento térmico.
- Tapa aislante de rosca con botón de apertura que mantiene el calor y dispensa fácilmente las bebidas.

- Pichet isotherme qui maintient les liquides chauds et froids pendant des heures.
- Idéales pour servir le café, lait ou le thé.
- Corps en polypropylène, léger et très pratique.
- Double paroi avec ampoule en de verre à l'intérieur qui confère un haut rendement thermique.
- Couvercle isolant à vis avec poussoir d'ouverture qui maintient la chaleur et distribue facilement les boissons.

- Thermos jug that keeps liquids hot and cold for hours.
- Ideal for coffee, milk or tea.
- Polypropylene body, light and very comfortable.
- Double skin with a glass layer inside to provide high thermal performance.
- Insulated screw cap with opening button for easy pouring and to keep the heat in the jug.



Triple pared aislante
Triple insulating wall



Jarra termo Wood
Pichet thermo · Thermoskanne
Termo jug · Jarra termo

| | Ref | € | cm | L | U.Venta |
|---|-------|-------|----------|------|---------|
| A | 62598 | 22,70 | Ø13x25,3 | 1,00 | 1 |
| B | 62599 | 22,70 | Ø13x25,3 | 1,00 | 1 |

Jarra Termo
Pichet thermo · Thermoskanne
Termo jug · Jarra termo

| | Ref | € | L | U.Venta |
|---|-------|-------|------|---------|
| A | 62563 | 15,30 | 1,00 | 1 |
| | 62564 | 17,50 | 1,50 | 1 |
| B | 62575 | 15,10 | 1,00 | 1 |
| | 62579 | 17,50 | 1,50 | 1 |

Jarra Termo Push
Pichet thermo · Thermoskanne
Termo jug · Jarra termo

| | Ref | € | L | U.Venta |
|--|-------|-------|------|---------|
| | 62496 | 27,80 | 0,60 | 1 |
| | 62491 | 39,90 | 1,20 | 1 |
| | 62492 | 50,10 | 2,00 | 1 |

Jarras termo



- Jarras termo que mantienen los líquidos calientes y fríos durante horas.
- Ideales para servir café, leche o té.
- Doble pared que proporciona un alto rendimiento térmico.
- Boca amplia; facilita su llenado y su limpieza.



Jarra Termo Suite
Verseuse isothermo · Thermoskanne, idoliert
Vacuum flask · Servidor termo

| Ref | € | L | U.Venta |
|-------|-------|-----|---------|
| 62522 | 51,30 | 1,6 | 1 |
| 62523 | 56,50 | 2,2 | 1 |

Jarra Termo Quick
Bouteille thermo · Thermoskanne
Insulated server · Jarra termo Luxe

| Ref | € | L | U.Venta |
|-------|-------|------|---------|
| 62430 | 57,20 | 0,30 | 1 |
| 62460 | 63,40 | 0,60 | 1 |
| 62410 | 70,10 | 1,00 | 1 |
| 62415 | 90,30 | 1,50 | 1 |

Jarra Termo Luxe
Bouteille thermo · Thermoskanne
Insulated server · Jarra termo

| Ref | € | L | U.Venta |
|-------|-------|------|---------|
| 63360 | 68,80 | 0,60 | 1 |
| 63310 | 74,90 | 1,00 | 1 |
| 63315 | 86,50 | 1,50 | 1 |
| 63320 | 92,20 | 2,00 | 1 |



Jarra Termo White & Black
Verseuse isothermo · Thermoskanne, idoliert
Vacuum flask · Servidor termo

| Ref | € | L | U.Venta |
|---------|-------|------|---------|
| A 62483 | 32,00 | 1,00 | 1 |
| B 62484 | 32,00 | 1,00 | 1 |



HINWEIS :
In Deutschland nicht verfügbar
Jarra termo Pot
Verseuse isothermo · Thermoskanne, idoliert
Vacuum flask · Servidor termo

| Ref | € | L | h (cm) | U.Venta |
|-------|-------|------|--------|---------|
| 62481 | 30,50 | 1,00 | 16 | 1 |
| 62485 | 36,10 | 1,50 | 20 | 1 |
| 62486 | 37,10 | 2,00 | 22 | 1 |



Termo Bala Inox
Thermo pour liquides · Thermobehälter für Flüssigkeiten
Thermo for liquids · Termo para líquidos

| Ref | € | L | h(cm) | U.Venta |
|-------|-------|------|-------|---------|
| 62441 | 12,30 | 0,35 | 20,0 | 1 |
| 62442 | 14,10 | 0,50 | 24,8 | 1 |
| 62443 | 19,00 | 0,75 | 29,8 | 1 |
| 62444 | 20,40 | 1,00 | 33,7 | 1 |

Boca ancha para cubitos hielo
Wide mouth for ice cubes



INOX

Air Pot
Air pot · Getränkespender, isoliert
Air pot · Air pot

| Ref | € | L | h (cm) | U.Venta |
|-------|--------|------|--------|---------|
| 62472 | 71,50 | 2,50 | 32,5 | 1 |
| 62473 | 77,60 | 3,00 | 34,5 | 1 |
| 62475 | 104,00 | 4,00 | 39,0 | 1 |

NO UTILIZAR CON BEBIDAS GASEOSAS, CALDOS NI LÁCTEOS

DO NOT USE WITH FIZZY DRINKS, BROTHS OR DAIRY

- Mantiene las bebidas calientes o frías durante 24 horas.
- Doble pared que proporciona un alto rendimiento térmico.
- Ligero e irrompible.
- Boca ancha para cubos de hielo.
- Fácil de abrir y cerrar. Fácil limpieza.

- Keep hot or cold drinks for 24 hours.
- Double wall that provides high thermal performance.
- Light and unbreakable.
- Wide mouth for ice cubes.
- Easy to open and close. Easy cleaning.



Termo alimentos



Termo para alimentos Flora
Thermo pour aliments · Thermobehälter für Speisen
Thermo for food · Termo para alimentos

| Ref | € | h(cm) | L | U.Venta |
|---------|-------|-------|------|---------|
| A 62635 | 13,90 | 14,5 | 0,36 | 1 |
| B 62636 | 24,20 | 15,0 | 0,50 | 1 |

Termo para alimentos Inox
Thermo pour aliments · Thermobehälter für Speisen
Thermo for food · Termo para alimentos

| Ref | € | L | h(cm) | U.Venta |
|-------|-------|------|-------|---------|
| 62448 | 21,50 | 0,70 | 19,7 | 1 |
| 62440 | 25,70 | 1,00 | 23,5 | 1 |

Termo para alimentos Soft Touch
Thermo pour aliments · Thermobehälter für Speisen
Thermo for food · Termo para alimentos

| Ref | € | L | h(cm) | U.Venta |
|-------|-------|------|-------|---------|
| 62480 | 53,50 | 1,50 | 18 | 1 |

Botellas & Vasos



- Fabricadas en acero inoxidable 18/10 de la mejor calidad.
- Doble pared de aislamiento, no transmiten el calor o el frío.
- Tapón de rosca hermético, a prueba de filtraciones y antiderrames.
- No transmiten sabores ni olores.
- Libres de BPA.

- Fabriqué en acier inoxydable 18/10 de la meilleure qualité.
- Double paroi d'isolement, ne transmettez pas la chaleur ou le froid.
- Bouchage de fil hermétique, fuite de fuites et antiderrames.
- Il ne transmet pas les saveurs ou les odeurs.
- Sans BPA.

- Made of stainless steel 18/10 of the best quality.
- Double isolation wall, do not transmit heat or cold.
- Hermetic thread plug, leak-proof of leaks and antiderrams.
- It does not transmit flavors or odors.
- BPA free.

Botellas Inox Edan
Bouteille inox · Stahlflasche
Stainless steel bottle · Garrafa de aço inoxidável

| Ref | € | L | U.Venta |
|---------|-------|------|---------|
| 62536 | 11,40 | 0,26 | 1 |
| A 62537 | 12,40 | 0,50 | 1 |
| 62538 | 15,40 | 0,75 | 1 |
| 62546 | 11,40 | 0,26 | 1 |
| B 62547 | 12,40 | 0,50 | 1 |
| 62548 | 15,40 | 0,75 | 1 |
| C 62585 | 12,40 | 0,50 | 1 |
| D 62588 | 12,40 | 0,50 | 1 |



Acabado exterior con proceso de revestimiento en polvo
Outside finished with powder coating process

Tapón de madera con anilla para colgar
Wood stopper with a ring for hanging



- Vaso reutilizable fabricado en vidrio borosilicato de gran espesor.
- Tapa de polipropileno con pestaña deslizando, libre de BPA.
- Cierre hermético; 100% a prueba de fugas. Banda de silicona antideslizante para un agarre seguro.
- Higiénico y resistente al contraste térmico. Diseñado para disfrutar de bebidas calientes o frías para llevar.
- No absorbe olores ni sabores. Fácil limpieza; apto para el lavavajillas.

- Reusable vessel manufactured in large thick borosilicate glass.
- Polypropylene lid with sliding tab, BPA free.
- Hermetic closure; 100% leak -proof. Non -slip silicone band for a safe grip.
- Hygienic and resistant to thermal contrast. Designed to enjoy hot or cold drinks to wear.
- It does not absorb odors or flavors. Easy cleaning; Apt for the dishwasher.

Botella inox Flora

Bouteille inox · Stahlflasche
Stainless steel bottle · Garrafa de aço inoxidável

| Ref | € | L | U.Venta |
|-------|-------|------|---------|
| 62556 | 14,50 | 0,50 | 1 |
| 62559 | 16,10 | 0,75 | 1 |

Tapón con doble protección a prueba de goteo

Drip proof double protected lid

Correa de transporte resistente
Strong carrying strap



VIDRIO BOROSILICATO Borosilicate Glass
PP Polypropylene
SI Silicone
Dishwasher

Vaso Serve & Go

Timbale · Trinkbecher
Tumbler · Copo

| Ref | € | ml | Ø (cm) | h (cm) | U.Venta |
|-------|-------|-----|--------|--------|---------|
| 63138 | 15,00 | 280 | 9 | 14,0 | 1 |
| 63139 | 17,00 | 450 | 9 | 17,0 | 1 |

TRITAN

Plastic

Botella personal Energy

Personnelle bouteille · Persönliche Flasche
Personal bottle · Garrafa pessoal

| Ref | € | L | U.Venta |
|-------|-------|------|---------|
| 61950 | 14,30 | 0,50 | 1 |
| 61965 | 15,50 | 0,65 | 1 |

Cierre hermético: tapa de rosca fabricada en bambú con junta de silicona
Hermetic closure: thread cover made of bamboo with a silicone joint



Filtro infusor de acero inoxidable 18/10 extraíble
Infusor filter of stainless steel 18/10 removable

Vidrio borosilicato de doble pared
Double quality double wall borosilicate glass.



- Vaso reutilizable fabricado en acero inoxidable de doble pared. **Mantiene las bebidas calientes o frías durante más tiempo.**
- Tapa de polipropileno con cierre de rosca, libre de BPA.
- DobleClip, giro de 180°. Cierre hermético; 100% a prueba de fugas.
- Banda de silicona antideslizante para un agarre seguro.
- Base de silicona antideslizante.
- Higiénico y resistente al contraste térmico.
- Diseñado para disfrutar de bebidas calientes o frías para llevar.
- No absorbe olores ni sabores

new

- This reusable glass in double-walled stainless steel. Keeps drinks hot or cold for a longer period of time.
- It has a BPA free polypropylene lid with screw-on closure.
- DoubleClip, Up 180°. Hermetic Seal: 100% leak proof.
- It has a non-slip silicone band for a secure grip.
- It has a non-slip silicone base.
- It's hygienic and resistant to thermal shock.
- It's designed to enjoy hot and cold drinks on the go.
- It doesn't absorb odours or favours.

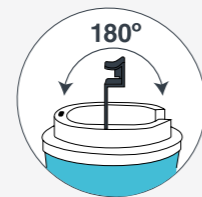

INOX
PP Polypropylene
SI Silicone

Vaso termo Ocean

Timbale isotherme · Thermo-Trinkbecher
Thermo tumbler · Copo térmico

| Ref | € | ml | h(cm) | U.Venta |
|-------|-------|-----|-------|---------|
| 63134 | 11,10 | 350 | 15,0 | 1 |
| 63135 | 11,50 | 500 | 17,0 | 1 |



Cafeteria Coffee

Molinillos de café



Molinillo Limu
Moulin à café · Kaffeemühle
Coffe grinder · Moedor de café

| Ref | € | W | Capacidad contenedor | U.Venta |
|-------|-------|-----|----------------------|---------|
| 69385 | 38,20 | 200 | 60 g | 1 |

- Ideal para moler café y otros alimentos como semillas, hierbas, frutos secos, cereales, sal, pimienta o especias.
- Muele al instante. Muelas cerámicas extrafuertes: no pierden filo y no se oxidan.
- Molido a baja velocidad: conserva mejor las propiedades y aromas.
- Funcionamiento sencillo. Muy fácil de limpiar.
- 8 niveles de grosor: obtén la molienda perfecta para ocasión.

- Ideal for grinding coffee and other foods such as seeds, herbs, nuts, cereals, salt, pepper or spices.
- Move instantly. Extrafuertes ceramic teeth: do not lose edge and do not oxidize.
- Low speed: Better preserves properties and aromas.
- Simple operation. Very easy to clean.
- 8 thickness levels: get the perfect grinding for occasion.

Mecanismo cerámico
Ceramic mechanism



8 niveles de grosor
8 grinding levels

CRISTAL INOX
Glass 18/10

Molinillo manual
Moulin manuel · Manuelle Mühle
Manual grinder · Moinho manual

| Ref | € | W | Capacidad contenedor | U.Venta |
|-------|-------|---|----------------------|---------|
| 62817 | 34,10 | | 45 g | 1 |

Espumadores de leche



- Disfruta de una espuma fina y cremosa en pocos segundos.
- Base independiente rotativa de 360°, fácil de rellenar y verter.
- Funcionamiento silencioso. Apagado automático.
- Indicador de luz que visualiza si la leche está caliente o fría.
- Apta para leches vegetales. Fácil de limpiar.

- Profitez d'une mousse fine et crémeuse en quelques secondes.
- Base rotative à 360°, facile à remplir et à verser.
- Fonctionnement silencieux. Électricité automatique.
- Indicateur léger qui visualise si le lait est chaud ou froid.
- Convient aux laits de légumes. Facile à nettoyer.

- 1.- Calentar
- 2.- Calentar y espumar. Espumar leche fría

- 1.- Heat
- 2.- Heat and froth. Froth cold milk



Espumador de leche Latte
Mousseur à lait · Milchaufschäumer
Milk frother · Espumador de leite

Espumador de leche Magnetic
Mousseur à lait · Milchaufschäumer
Milk frother · Espumador de leite

| Ref | € | W | Capacidad | Capacidad espuma | Medidas | U.Venta |
|-------|-------|-----|-----------|------------------|-----------|---------|
| 69396 | 63,50 | 500 | 240ml | 115 ml | Ø10x21 cm | 1 |

| Ref | € | W | Capacidad | Capacidad espuma | Medidas | U.Venta |
|-------|-------|-----|-----------|------------------|-------------|---------|
| 69398 | 78,90 | 600 | 250ml | 115 ml | Ø12x19,5 cm | 1 |

Cafeteras espresso



Apta para café molido y cápsulas ESE
Suitable for ground coffee and ESE capsules



Cafetera espresso Compact
Cafetière espresso · Espresso-Maschine
Espresso coffee maker · Cafeteira espresso

| Ref | € | W | Capacidad | Presión | Medidas | U.Venta |
|-------|--------|------|-----------|---------|-------------|---------|
| 69429 | 235,20 | 1450 | 1,25L | 20 bar | 14x31x31 cm | 1 |



Prepara 1 o 2 cafés
Make 1 or 2 coffees



Calienta y espuma la leche
Heat and froth milk



Apta para café molido y cápsulas ESE
Suitable for ground coffee and ESE capsules



Cafetera espresso Sence
Cafetière espresso · Espresso-Maschine
Espresso coffee maker · Cafeteira espresso

| Ref | € | W | Capacidad | Presión | Medidas | U.Venta |
|-------|--------|-----|-----------|---------|---------------|---------|
| 69256 | 189,20 | 850 | 1,5L | 15 bar | 21x26,5x30 cm | 1 |



Prepara 1 o 2 cafés
Make 1 or 2 coffees



Calienta y espuma la leche
Heat and froth milk

- Ideal para preparar todo tipo de cafés, espresso, cappuccino, latte machiato, té o infusiones.
- Su sistema de calentamiento rápido Thermoblock calienta el agua en segundos.
- Función manual y automática. Permite programar el ciclo de vertido a tu gusto.
- Incluye vaporizador con rotación para espumar leche y preparar cappuccino. También dispensa agua caliente para las infusiones.
- Brazo portafiltros con doble salida, te permite preparar uno o dos cafés simultáneamente.
- Bandeja caliente tazas de acero inoxidable, calienta la taza previamente para evitar el contraste térmico.
- Incluye cucharilla dosificadora con prensador para el café y 3 filtros (individual, doble y para usar cápsulas ESE) para acoplar al brazo de la cafetera.
- Sistema de ahorro energético con apagado automático.
- Apta para usar con café molido y con cápsulas ESE.
- Ideal to prepare all kinds of coffees, espresso, cappuccino, late machiato, teas or infusions.
- Your fast heating system Thermoblock heats the water in seconds.
- Manual and automatic function. Allows you to program the dumping cycle to your liking.
- Includes rotation vaporizer for foam milk and prepare cappuccino. It also dispenses hot water for infusions.
- Double outlet portafiltros arm, allows you to prepare one or two coffees simultaneously.
- Heat stainless steel cups tray, heat the cup previously to avoid thermal contrast.
- Includes dosing teaspoon with coffee presser and 3 filters (individual, double and to use that) to attach to the coffee maker.
- Removable drip tray with level indicator to facilitate cleaning.
- Energy savings system with automatic shutdown.
- Suitable to use with ground coffee and that with that.

- Ideal para preparar todo tipo de cafés, espresso, cappuccino, latte machiato, té o infusiones.
- Café perfecto y rápido gracias a su potencia y sus bares de presión.
- Sistema de calentamiento rápido Thermoblock, calienta el agua en segundos.
- Fácil de usar, muy intuitiva. Indicadores luminosos en cada función.
- Función manual y automática. Permite programar el ciclo de vertido a tu gusto.
- Incluye vaporizador con rotación para espumar leche, preparar cappuccinos y también dispensar agua caliente para las infusiones.
- Brazo portafiltros con doble salida; te permite preparar uno o dos cafés simultáneamente.
- Depósito de agua extraíble con marcas de máximo y mínimo. Libre de BPA.
- Bandeja caliente tazas de acero inoxidable, calienta la taza previamente para evitar el contraste térmico.
- Bandeja de goteo desmontable con indicador de nivel para facilitar la limpieza.
- Sistema de ahorro energético con apagado automático.
- Apta para usar con café molido y con cápsulas ESE (69256 / 69429).

- Ideal to prepare all kinds of coffees, espresso, cappuccino, late machiato, teas or infusions.
- Perfect and fast coffee thanks to its power and pressure bars.
- Thermoblock fast heating system, heats the water in seconds.
- Easy to use, very intuitive. Luminous indicators in each function.
- Manual and automatic function. Allows you to program the dumping cycle to your liking.
- Includes rotation vaporizer for milk foam, prepare cappuccinos and also dispense hot water for infusions.
- Portafiltros arm with double outlet; It allows you to prepare one or two coffees simultaneously.
- Removable water tank with maximum and minimum marks. BPA free.
- Heat stainless steel cups tray, heat the cup previously to avoid thermal contrast.
- Removable drip tray with level indicator to facilitate cleaning.
- Energy savings system with automatic shutdown.
- Suitable for use with ground coffee and with that (69256 / 69429).



Accesorios
Accessories



Depósito de café
Coffee tank



Prepara
1 o 2 cafés
Make 1 or 2 coffees



Calienta y espuma
la leche
Heat and froth milk



Cafetera Espresso Pro

Cafetière espresso · Espresso-Maschine
Espresso coffee maker · Cafeteira espresso

| Ref | € | W | Capacidad | Capacidad contenedor | Presión | Medidas | U.Venta |
|-------|--------|------|-----------|----------------------|---------|-----------------|---------|
| 69428 | 659,40 | 1550 | 2,8L | 250 g (café/Coffee) | 20 bar | 31x34,5x41,5 cm | 1 |

- Ideal para preparar todo tipo de cafés, espresso, capuccino, latte machiato, té o infusiones.
- Molinillo con fresa cónica de acero inoxidable integrado, proporciona la cantidad necesaria de café.
- Depósito de café de 250 g con opción de regular entre 30 tipos de molido. Libre de BPA.
- Control de temperatura PID. Alcanza la temperatura de extracción óptima.
- Fácil de usar, muy intuitiva. Indicadores luminosos en cada función.
- Función manual y automática. Permite programar la cantidad de vertido a tu gusto.
- Incluye vaporizador con rotación para espumar la leche y preparar cappuccino. También dispensa agua caliente para las infusiones.
- Brazo portafiltros con doble salida; te permite preparar uno o dos cafés simultáneamente.
- Incluye prensador de acero inoxidable para el café, 2 filtros (individual y doble) para acoplar al brazo de la cafetera y jarra de acero inoxidable de 0,46 L para la leche.
- Bandeja de goteo desmontable con indicador de nivel para facilitar la limpieza.
- Sistema de ahorro energético con apagado automático.

- deal to prepare all kinds of coffees, espresso, cappuccino, late machiato, teas or infusions.
- Milling with conical stainless steel strawberry integrated, provides the necessary quantity of coffee.
- 250 g coffee tank with an option to regulate between 30 types of ground. BPA free.
- PID temperature control. Reach the optimal extraction temperature.
- Easy to use, very intuitive. Luminous indicators in each function.
- Manual and automatic function. It allows to program the amount of discharge to your liking.
- Includes rotation vaporizer to foam milk and prepare cappuccino. It also dispenses hot water for infusions.
- Portafiltros arm with double outlet; It allows you to prepare one or two coffees simultaneously.
- Includes stainless steel presier for coffee, 2 filters (individual and double) to attach the coffee maker and 0.46 l stainless steel jug for milk.
- Removable drip tray with level indicator to facilitate cleaning.
- Energy savings system with automatic shutdown.



Prepara
1 o 2 cafés
Make 1 or 2 coffees



Calienta y espuma
la leche
Heat and froth milk

Doble salida de café regulable en altura
Double coffee spout adjustable in height



Cafetera automática Sabore

Machine à café automatique · Automatische Kaffeemaschine
Automatic coffee machine · Máquina de café automática

| Ref | € | W | Capacidad | Capacidad contenedor | Presión | Medidas | U.Venta |
|-------|--------|------|-----------|----------------------|---------|-------------|---------|
| 69435 | 554,10 | 1350 | 1,5L | 180g | 20 bar | 44x19x32 cm | 1 |

- Cafetera superautomática compacta y diseñada para los amantes del café recién molido. Pantalla intuitiva táctil.
- Disfruta del café recién hecho con grano molido.
- Se puede ajustar la cantidad de café para cada una de las 3 funciones.
- Molinillo ajustable de muelas cónicas: 15 niveles de molienda. Ajusta el grano de molienda a tu gusto.
- Gran capacidad: Hasta 180 gramos de café y depósito de agua de 1,5L.
- Calentamiento ThermoBlock: Sistema eléctrico de calentamiento del agua ultra rápido. Disfruta de un café recién molido al instante.
- Doble salida de café regulable en altura desde 8,5 cm hasta 11,5 cm.
- AutoClean System: Sistema de limpieza automático.
- Molinillo y depósito para residuo totalmente accesible: facilita su limpieza.
- Incluye vaporizador para calentar y espumar la leche o calentar agua para infusiones.

- Machine à café superautomatique compacte conçue pour les amateurs de café fraîchement moulu. Écran tactile intuitif.
- Savourez un café fraîchement préparé avec des grains moulus.
- La quantité de café est réglable pour chacune des 3 fonctions.
- Moulin conique réglable : 15 niveaux de mouture. Ajustez la mouture à votre goût.
- Grande capacité : Jusqu'à 180 grammes de café et un réservoir d'eau de 1,5 litre.
- Chauffage ThermoBlock : Système de chauffage électrique de l'eau ultra-rapide. Profitez instantanément d'un café fraîchement moulu.
- Double écoulement de café réglable en hauteur de 8,5 cm à 11,5 cm.
- Système AutoClean : Système de nettoyage automatique.
- Le moulin et le bac à déchets sont entièrement accessibles, ce qui facilite le nettoyage.
- Mousseur inclus pour chauffer et faire mousser le lait ou chauffer l'eau pour les infusions.

- Compact superautomatic coffee machine designed for lovers of freshly ground coffee.
- Enjoy freshly brewed coffee with ground beans. Intuitive touch screen
- The amount of coffee can be adjusted for each of the 3 functions.
- Adjustable conical grinder: 15 grinding levels. Adjust the grind to your taste.
- Large capacity: Up to 180 grams of coffee and 1.5L water tank.
- ThermoBlock heating: Ultra-fast electric water heating system. Enjoy freshly ground coffee instantly.
- Double coffee spout adjustable in height from 8.5 cm to 11.5 cm.
- AutoClean System: Automatic cleaning system.
- Fully accessible grinder and waste container: easy to clean.
- Includes frother for heating and frothing milk or heating water for infusions.



Cafeteras Italianas Inox



- Cafetera italiana fabricada en acero inoxidable 18/10 de gran calidad y máxima resistencia.
- Máxima seguridad garantizada: dispone de válvula de seguridad y asa termoresistente.
- 100% hermético gracias a su junta de cierre de silicona.
- Alta conductividad térmica.
- Fondo FULL INDUCTION: apta para todo tipo de fuegos, incluida la inducción.

- Cafetière italienne fabriquée en acier inoxydable 18/10 de haute qualité et résistance maximale.
- Sécurité maximale garantie: il a une soupape de sécurité et une poignée résistante au thermor.
- 100% hermétique grâce à son articulation de fermeture en silicone.
- Haute conductivité thermique.
- Fonds complet à induction: Convient à tous les types d'incendies, y compris l'induction.

Disponen de válvula de seguridad
They have a safety valve



- Italian coffee maker manufactured in stainless steel 18/10 of high quality and maximum resistance.
- Maximum guaranteed security: It has safety valve and thermor resistant handle.
- 100% hermetic thanks to its silicone closure joint.
- High thermal conductivity.
- Full induction fund: suitable for all types of fires, including induction.

Acabado MATE
SATIN finish



Cafetera Express Hyperluxe

Cafetière express · Esspressokocher
Express coffee · Cafeteira café expresso

| Ref | € | Tazas | U.Venta |
|-------|--------|-------|---------|
| 62074 | 82,60 | 4 | 1 |
| 62076 | 91,20 | 6 | 1 |
| 62071 | 104,30 | 10 | 1 |

Acabado BRILLO
GLOSS finish



Cafetera Express Milan

Cafetière express · Esspressokocher
Express coffee pot · Cafeteira espresso

| Ref | € | Tazas | U.Venta |
|-------|-------|-------|---------|
| 62033 | 22,10 | 4 | 1 |
| 62036 | 25,80 | 6 | 1 |
| 62031 | 32,20 | 10 | 1 |

Acabado BRILLO
GLOSS finish



Cafeteras Express Luxe

Cafetière express · Esspressokocher
Express coffee · Cafeteira café expresso

| Ref | € | Tazas | U.Venta |
|-------|-------|-------|---------|
| 62084 | 67,60 | 4 | 1 |
| 62086 | 78,90 | 6 | 1 |
| 62081 | 93,20 | 10 | 1 |

Acabado BRILLO
GLOSS finish



Cafetera Express Siena

Cafetière express · Esspressokocher
Express coffee pot · Cafeteira espresso

| Ref | € | Tazas | U.Venta |
|-------|-------|-------|---------|
| 62124 | 49,90 | 4 | 1 |
| 62126 | 60,30 | 6 | 1 |
| 62121 | 72,10 | 10 | 1 |

Acabado BRILLO
GLOSS finish



Cafeteras Express Moka

Cafetière express · Esspressokocher
Express coffee pot · Cafeteira espresso

| Ref | € | Tazas | U.Venta |
|-------|-------|-------|---------|
| 62054 | 56,50 | 4 | 1 |
| 62056 | 64,70 | 6 | 1 |
| 62051 | 76,70 | 10 | 1 |

Acabado BRILLO
GLOSS finish



Cafetera Pava

Cafetière pava · Kaffeekanne Pava
Coffee pot · Chaleira

| Ref | € | L | U.Venta |
|-------|-------|------|---------|
| 68215 | 35,60 | 1,00 | 1 |
| 68225 | 42,90 | 2,00 | 1 |
| 68235 | 52,40 | 2,80 | 1 |
| 68205 | 60,30 | 4,00 | 1 |



Cafeteras Italianas Aluminio



- Cafetera italiana fabricada en aluminio fundido de gran calidad y máxima resistencia.
- Máxima seguridad garantizada: dispone de válvula de seguridad y asa de baquelita (Turin) / asa de madera de Haya (Trento) termorresistente.
- 100% hermético gracias a su junta de cierre de silicona.
- Alta conductividad térmica.

- Cafetières italienne fabriquées en fonte d'aluminium de grande qualité et d'une résistance maximale.
- Sécurité maximum garantie : dispose d'une soupape de sécurité et d'une anse en bakélite (Turin) anse en bois de hêtre (Trento) thermostable.
- 100% hermétique grâce à son joint de fermeture en silicone.

- Haute conductivité thermique.
- Moka pot coffee maker made of high quality and very strong cast aluminium.
- Guaranteed maximum safety: pressure valve and heat resistant bakelite handle (Turin) / beech wood handle (Trento).
- 100% Hermetic because of the silicone seal.
- High thermal conductivity.



Cafetera Express Turin
Cafetière express · Espressoemaker
Express coffee pot · Cafeteira expresso

| Ref | € | Tazas | Base (cm) | U.Venta |
|-------|-------|-------|-----------|---------|
| 62026 | 17,40 | 6 | 9,5 | 1 |
| 62029 | 21,70 | 9 | 10,5 | 1 |
| 62022 | 23,90 | 12 | 12,0 | 1 |



Cafetera Express Trento
Cafetière express · Espressoemaker
Express coffee pot · Cafeteira expresso

| | Ref | € | Tazas | Base (cm) | h(cm) | U.Venta |
|---|-------|-------|-------|-----------|-------|---------|
| A | 62046 | 30,70 | 6 | 8,5 | 20,0 | 1 |
| | 62048 | 39,10 | 9 | 9,0 | 22,5 | 1 |
| B | 62096 | 30,70 | 6 | 8,5 | 20,0 | 1 |
| | 62099 | 39,10 | 9 | 9,0 | 22,5 | 1 |



Cafeteras Francesas

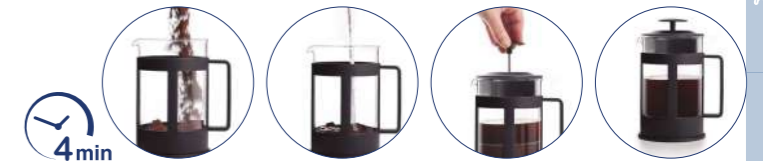

- Fabricada en vidrio borosilicato, superresistente a los cambios de temperatura.
- Filtro robusto de acero inoxidable 18/10; asegura una buena textura y sabor.
- Forma práctica y sencilla de preparar los mejores cafés e infusiones en pocos minutos.

- Fabriqué dans du verre borosilicate, changements de température.
- Filtre inoxydable en acier inoxydable 18/10; Assure une bonne texture et une bonne saveur.
- Moyen pratique et simple de préparer les meilleurs cafés et perfusions en quelques minutes.

- Manufactured in borosilicate glass, temperature changes.
- Stainless steel stainless filter 18/10; ensures good texture and flavor.
- Practical and simple way to prepare the best coffees and infusions in a few minutes.



Cafetera francesa
Cafetière à piston · Französische Kaffemaschine
French coffee maker · Cafeteira francesa

| | Ref | € | Tazas | L | U.Venta |
|---|-------|-------|-------|------|---------|
| A | 62173 | 19,60 | 3 | 0,35 | 1 |
| | 62178 | 26,80 | 6 | 0,80 | 1 |
| B | 62183 | 8,50 | 3 | 0,35 | 6 |
| | 62186 | 13,20 | 6 | 0,80 | 1 |



Cafetera francesa Wood
Cafetière à piston · Französische Kaffemaschine
French coffee maker · Cafeteira francesa

| | Ref | € | Tazas | L | U.Venta |
|--|-------|-------|-------|------|---------|
| | 62163 | 11,20 | 3 | 0,35 | 1 |
| | 62168 | 15,00 | 6 | 0,80 | 1 |
| | 62161 | 15,50 | 8 | 1,00 | 1 |



INOX

Cafetera de cristal
Cafetière en verre · Glaskaffeemaschine
Coffee pot w/glass · Cafeteira vidro

| | Ref | € | Tazas | L | U.Venta |
|--|-------|-------|-------|------|---------|
| | 62153 | 30,40 | 2 | 0,35 | 1 |
| | 62180 | 43,10 | 6 | 0,80 | 1 |



Cafetera Francesa Inox
Cafetière à piston inox · Französische Kaffepresse inox
French coffee maker inox · Cafeteira francesa inox

| | Ref | € | L | U.Venta |
|--|-------|-------|-----|---------|
| | 62141 | 39,60 | 1,0 | 1 |

Classic Collection

INOX 18/10
Dishwasher



Tetera
Théière · Teekanne
Tea pot · Bule

| Ref | € | L | U.Venta |
|-------|-------|------|---------|
| 62023 | 19,40 | 0,23 | 12 |
| 62035 | 21,60 | 0,35 | 12 |
| 62060 | 29,40 | 0,60 | 6 |
| 62010 | 36,10 | 1,00 | 1 |



Cafetera
Cafetière · Kaffeekanne
Coffee pot · Cafeteira

| Ref | € | L | U.Venta |
|-------|-------|------|---------|
| 62135 | 23,50 | 0,35 | 6 |
| 62160 | 31,60 | 0,60 | 6 |
| 62110 | 35,00 | 1,00 | 6 |
| 62115 | 48,90 | 1,50 | 1 |
| 62120 | 56,30 | 2,00 | 1 |



Lechera
Cremiere · Milchkanne
Creamer · Leiteira

| Ref | € | L | U.Venta |
|-------|-------|------|---------|
| 62215 | 9,00 | 0,15 | 6 |
| 62225 | 14,40 | 0,25 | 6 |
| 62235 | 15,10 | 0,35 | 6 |
| 62260 | 17,70 | 0,60 | 6 |
| 62210 | 22,10 | 1,00 | 6 |
| 62216 | 34,30 | 1,50 | 6 |
| 62220 | 40,90 | 2,00 | 1 |

Azucarero
Sucrier · Zuckerdose
Sugar bowl · Açucareiro

| Ref | € | L | U.Venta |
|-------|-------|------|---------|
| 62001 | 16,40 | 0,23 | 6 |
| 62003 | 21,30 | 0,35 | 1 |

Luxe Collection

INOX 18/10
Dishwasher



Tetera
Théière · Teekanne
Tea pot · Bule

| Ref | € | L | U.Venta |
|-------|-------|------|---------|
| 65025 | 38,80 | 0,25 | 1 |
| 65035 | 41,10 | 0,35 | 1 |
| 65060 | 48,50 | 0,60 | 1 |
| 65012 | 61,00 | 1,20 | 1 |



Cafetera
Cafetière · Kaffeekanne
Coffee pot · Cafeteira

| Ref | € | L | U.Venta |
|-------|-------|------|---------|
| 65135 | 40,50 | 0,35 | 1 |
| 65160 | 48,40 | 0,60 | 1 |
| 65110 | 61,40 | 1,00 | 1 |



Lechera
Cremiere · Milchkanne
Creamer · Leiteira

| Ref | € | L | U.Venta |
|-------|-------|------|---------|
| 65215 | 14,70 | 0,15 | 6 |
| 65235 | 25,20 | 0,35 | 6 |
| 65260 | 30,30 | 0,60 | 6 |

Batidor Capuccino

INOX AS Plastic Dishwasher BPA free



Batidor Capuccino
Batteur pour cappuccino · Capuccino-Mixer
Capuccino mixer · Batedor capuccino

| Ref | € | W | U.Venta |
|-------|-------|-----|---------|
| 69041 | 27,40 | 2,7 | 1 |

Incluye: Vaso medidor
Base para guardar el batidor y varillas
Varilla agitadora
Varilla para espumar
Batidor
Mezclador

Includes: Measuring cup
Base to store the whisk and rods
Stirring rod
Frothing rod
Whisk
Mixer

Teteras de hierro

FE CAST Iron Colado Induction Vitro Electric Gas Dishwasher ECO PFOA free

- Fabricadas artesanalmente en hierro fundido de alta calidad muy resistentes.
- Incluyen infusor extraíble de acero inoxidable.
- Interior esmaltado para evitar la oxidación.
- Se recomienda hacer uso de un hervidor para calentar el agua y evitar así que pierda el color.

- Fonte de haute qualité fait à la main.
- Ils comprennent des infuseurs en acier inoxydable amovibles.
- Intérieur émaillé pour éviter l'oxydation.
- Il est recommandé d'utiliser une bouilloire pour chauffer l'eau et éviter de perdre la couleur.

- Handmade high quality cast iron.
- They include removable stainless steel infuses.
- Enameled interior to avoid oxidation.
- It is recommended to use a kettle to heat the water and avoid losing the color.



Incluye filtro extraíble de acero inoxidable
Includes removable stainless steel filter



Tetera
Théière · Teekanne
Tea pot · Bule

| Ref | € | L | U.Venta |
|-------|-------|------|---------|
| 68663 | 30,10 | 0,25 | 1 |
| 68667 | 40,30 | 0,50 | 1 |
| 68666 | 33,60 | 0,60 | 1 |
| 68664 | 49,00 | 0,70 | 1 |
| 68662 | 44,90 | 0,80 | 1 |
| 68668 | 36,90 | 0,80 | 1 |
| 68661 | 41,60 | 1,10 | 1 |



Lecheras Collection



Dishwasher

INOX

Lechera

Pot crémier · Milchkanne
Milk jug · Leiteira

| | Ref | € | L | U.Venta |
|---|-------|-------|------|---------|
| A | 58151 | 14,00 | 0,35 | 1 |
| | 58152 | 16,70 | 0,60 | 1 |
| B | 58251 | 14,00 | 0,35 | 1 |
| | 58252 | 16,70 | 0,60 | 1 |
| C | 58153 | 14,00 | 0,35 | 1 |
| | 58253 | 16,70 | 0,60 | 1 |

INOX 18/10

Lechera Barista

Pot crémier pour baristas · Milchkanne für Baristas
Barista milk jug · Leiteira barista

| | Ref | € | L | U.Venta |
|---|-------|-------|------|---------|
| A | 58050 | 29,20 | 0,50 | 1 |
| B | 58150 | 32,20 | 0,50 | 1 |
| C | 58250 | 32,20 | 0,50 | 1 |
| D | 58450 | 32,10 | 0,50 | 1 |



Hervidor Silbante

INOX 18/10



Hervidor Silbante

Bouilloire siffiante · Flötenwasserkessel
Whistling kettle · Chaleira com apito

| | Ref | € | L | U.Venta |
|---|-------|-------|------|---------|
| A | 68619 | 38,40 | 2,00 | 1 |
| | 68627 | 40,50 | 2,50 | 1 |
| | 68629 | 43,00 | 3,00 | 1 |
| | 68639 | 44,50 | 4,00 | 1 |
| B | 68643 | 47,70 | 2,50 | 1 |
| C | 68644 | 47,70 | 2,50 | 1 |



Alto nivel de calidad y resistencia.
Apto para hervir agua o calentar café preparado.
Emite un ligero silbido cuando el agua hierve.

High level of quality and resistance.
Apt to boil water or heat prepared coffee.
It emits a slight whistle when the water boils.

Dispensador de agua caliente

INOX



Dispensador de agua caliente

Distributeur d'eau chaude · Heißwasserspender
Hot water dispenser · Dispensador de água quente

| Ref | € | L | W | Niveles calentamiento | Medidas | U.Venta |
|-------|--------|-----|------|---------------------------|-------------|---------|
| 69298 | 127,90 | 2 L | 2400 | 25°C - 70°C - 85°C - 95°C | 32x17x33 cm | 1 |

Agua caliente en 5 segundos
Hot water in 5 seconds

Bandeja de goteo extraíble e imantada
Removable and magnetic drip tray



Hervidores de agua

INOX 18/10



Base independiente rotativa de 360°
Independent base rotates 360°



Interior inox 18/10
Interior 18/10 st. steel

Strix Technology



Interior inox 18/10.
Interior 18/10 st. steel.



CE
Ceramic

Hervidor de agua Retro

Bouilloire électrique · Elektrische Wasserwamer
Electric kettle · Chaleira eléctrica

| Ref | € | W | Capacidad | Medidas | U.Venta |
|-------|-------|------|-----------|---------------------|---------|
| 69397 | 59,80 | 2200 | 1,7L | 26 x 19,5 x 26,5 cm | 1 |



Hervidor de agua

Bouilloire · Wasserwamer
Kettle · Chaleira

| | Ref | € | W | L | Medidas | U.Venta |
|---|-------|-------|------|-----|-------------|---------|
| A | 69591 | 22,60 | 2200 | 1,3 | 20x15x21 cm | 1 |
| B | 69590 | 22,60 | 2200 | 1,3 | 20x15x21 cm | 1 |



Fácil llenado
Easy filling



Hervidor de agua Rapid

Bouilloire · Wasserwamer
Kettle · Chaleira

| Ref | € | W | Capacidad | Medidas | U.Venta |
|-------|-------|------|-----------|-----------------|---------|
| 69291 | 40,90 | 1630 | 1,0L | 22 x 16 x 21 cm | 1 |
| 69297 | 51,10 | 2200 | 1,7L | 22 x 18 x 23 cm | 1 |

Hervidor de agua Gala

Bouilloire en céramique · Keramik Wasserwamer
Ceramic kettle · Chaleira cerâmica

| Ref | € | W | Capacidad | Medidas | U.Venta |
|-------|-------|------|-----------|-----------------|---------|
| 69276 | 53,10 | 1500 | 1,2L | 24 x 17 x 25 cm | 1 |

Strix Technology

Hervidor de agua Lake

Bouilloire · Wasserwamer
Kettle · Chaleira

| Ref | € | W | Capacidad | Medidas | U.Venta |
|-------|-------|------|-----------|-----------------|---------|
| 69277 | 61,30 | 2200 | 1,7 L | 23 x 16 x 23 cm | 1 |



Protección de ebullición en seco
Dry boil protection

CRISTAL
Glass

Hervidor de agua Vista

Bouilloire · Wasserwamer
Kettle · Chaleira

| Ref | € | W | L | Medidas | U.Venta |
|-------|-------|------|------|-------------|---------|
| 69292 | 80,70 | 2200 | 1,70 | 23x23x32 cm | 1 |



50 - 95°C max

Bar / Bodega

Bar / Wine cellar



Fundas enfriabotellas

TELA
Cloth

OEKO-TEX®
CONFIDENCE IN TEXTILES
STANDARD 100

FSC

Dishwasher



- Funda térmica; enfría y mantiene la temperatura durante más tiempo.
- Se adapta a todo tipo de botellas.
- Cubre prácticamente toda la botella, desde la base hasta al cuello.
- Nota: mete la funda térmica en el congelador antes de su uso. El gel refrigerante no es tóxico. Para lavarlo, utilizar un paño húmedo. No apto para el lavavajillas.

- Cas thermique; refroidir et garder la température plus longtemps.
- Il s'adapte à tous les types de bouteilles.
- Il couvre pratiquement toute la bouteille, de la base au cou.
- Remarque: Mettez le boîtier thermique dans le congélateur avant utilisation. Le gel réfrigérant n'est pas toxique. Pour le laver, utilisez un chiffon humide. Pas adapté au lave-vaisselle.

- Thermal case; cool and keep the temperature for longer.
- It adapts to all types of bottles.
- It covers practically the entire bottle, from the base to the neck.
- Note: put the thermal case in the freezer before use. Refrigerant gel is not toxic. To wash it, use a damp cloth. Not suitable for dishwasher.



Fundas enfriabotellas

Housse de refroidissement de bouteilles · Flaschenkühler
Bottle cooler cover · Arrefecedor de garrafas

| | Ref | € | cm | h (cm) | U.Venta |
|---|-------|-------|-------|--------|---------|
| A | 62276 | 15,10 | 15x23 | 3,5 | 1 |
| B | 62277 | 15,10 | 15x23 | 3,5 | 1 |
| C | 62270 | 15,10 | 15x23 | 3,5 | 1 |
| D | 62288 | 14,70 | 15x23 | 3,5 | 1 |

Fundas enfriabotellas Classic

Housse de refroidissement de bouteilles · Flaschenkühler
Bottle cooler cover · Arrefecedor de garrafas

| | Ref | € | U.Venta |
|---|-------|-------|---------|
| A | 62325 | 10,90 | 6 |
| B | 62355 | 11,60 | 6 |

Cubiteras



Cubitera de silicona flexible. Fácil de desmoldar
Flexible silicone ice cube tray/Easy to unmould



Cubitera Glacier
Bac à glaçon · Eismwürfelschale
Ice cube tray · Cuvete para gelo

| Ref | € | Cubitos | Cubitos (cm) | cm | h(cm) | U.Venta |
|-------|-------|---------|--------------|---------|-------|---------|
| 63336 | 16,90 | 32 | 2,5x2,5x1,8 | 22,5x12 | 10,5 | 1 |

Orificio para un llenado fácil
Orifice for easy filling



Cubitera Fresh
Bac à glaçon · Eismwürfelschale
Ice cube tray · Cuvete para gelo

| Ref | € | Cubitos | Cubitos (cm) | cm | h(cm) | U.Venta |
|-------|------|---------|--------------|---------|-------|---------|
| 63337 | 4,40 | 16 | 4,5x3x3 | 30x11,5 | 4,6 | 1 |

Orificio para un llenado fácil
Cubitera de silicona flexible. Fácil de desmoldar
Orifice for easy filling
Flexible silicone ice cube tray/Easy to unmould



Cubitera Ice
Bac à glaçon · Eismwürfelschale
Ice cube tray · Cuvete para gelo

| Ref | € | Cubitos | Cubitos (cm) | cm | h(cm) | U.Venta |
|-------|------|---------|--------------|---------|-------|---------|
| 63338 | 8,70 | 15 | 3x3x2,5 | 20x11,5 | 3,5 | 1 |

Cubitera de silicona flexible. Fácil de desmoldar
Flexible silicone ice cube tray/Easy to unmould



Cubitera Ice XL
Bac à glaçon · Eismwürfelschale
Ice cube tray · Cuvete para gelo

| Ref | € | Cubitos | Cubitos (cm) | cm | h(cm) | U.Venta |
|-------|------|---------|--------------|-----------|-------|---------|
| 63339 | 8,30 | 6 | 4,5x4,5x4,5 | 15,5x10,5 | 4,5 | 1 |

- **Cubitera de hielo fabricada en silicona de grado alimenticio.**
- **Capacidad para hacer 32 cubitos de hielo de 2,5x2,5x1,8 cm de tamaño.**
- **Contenedor fabricado en polipropileno para almacenar hasta 96 cubitos.**
- **Evita que los hielos adquieran sabores u olores.**
- **Incluye 2 tapas para tapar la cubitera y el contenedor de manera simultánea.**
- **Gracias a su gran flexibilidad podrás sacar los cubitos de forma rápida y sencilla.**
- **Libre de BPA.**

- Ice cube tray made of food grade silicone.
- Capacity for making 32 2,5x2,5x1,8 cm ice cubes.
- Container made of polypropylene for storing up to 96 ice cubes.
- Keeps the ice cubes from taking on flavours or odours.
- Includes 2 lids for covering the ice cube tray and the container at the same time.
- You can get the ice cubes out quickly and easily and almost effortlessly because it's extremely flexible.
- BPA free.

- **Cubitera de hielo fabricada en polipropileno. Libre de BPA.**
- **Capacidad para hacer 16 cubitos de hielo de 4,5x3x3 cm de tamaño.**
- **Evita que los hielos adquieran sabores u olores gracias a su tapa hermética.**
- **La tapa incluye un orificio para un llenado fácil sin derrames o salpicaduras.**

- Bac à glaçons fabriqué en polypropylène. Sans BPA.
- Capacité pour faire 16 glaçons d'une taille de 4,5x3x3 cm.
- Évite aux glaçons d'absorber des goûts ou des odeurs grâce à son couvercle hermétique.
- Le couvercle comprend un trou pour faciliter le remplissage sans renverser ou éclabousser.

- Ice cube tray made of polypropylene. BPA free.
- Capacity for making 16 ice cubes of 4,5x3x3 cm in size.
- Keeps the ice cubes from taking on flavours or odours thanks to its hermetic lid.
- The lid includes a hole for easy filling without spilling or splashing.

- **Cubitera de hielo fabricada en silicona. Libre de BPA.**
- **Capacidad para hacer 15 cubitos de hielo de 3x3x2,5 cm de tamaño.**
- **Evita que los hielos adquieran sabores u olores gracias a su tapa hermética.**
- **La tapa incluye un orificio para un llenado fácil sin derrames o salpicaduras.**
- **Gracias a su gran flexibilidad podrás sacar los cubitos de forma rápida y sencilla.**

- Ice cube tray made of silicone. BPA free.
- Capacity for making 15 ice cubes of 3x3x2,5 cm in size.
- Keeps the ice cubes from taking on flavours or odours thanks to its hermetic lid.
- The lid includes a hole for easy filling without spilling or splashing.
- You can get the ice cubes out quickly and easily and almost effortlessly because it's extremely flexible.

- **Cubitera de hielo fabricada en silicona. Libre de BPA.**
- **Capacidad para hacer 6 cubitos de hielo XL de 4,5x4,5x4,5 cm de tamaño.**
- **Mantiene las bebidas frías durante más tiempo.**
- **Gracias a su gran flexibilidad podrás sacar los cubitos de forma rápida y sencilla.**

- Bac à glaçons fabriqué en silicone. Sans BPA.
- Capacité pour faire 6 glaçons XL d'une taille de 4,5x4,5x4,5 cm.
- Garde les boissons plus froides plus longtemps.
- Grâce à sa grande flexibilité, les glaçons pourront être retirés de façon rapide et simple, presque sans efforts.

- Ice cube tray made of silicone. BPA free.
- Capacity for making 6 XL ice cubes of 4,5x4,5x4,5 cm in size.
- Keeps drinks cold for longer.
- You can get the ice cubes out quickly and easily and almost effortlessly because it's extremely flexible.

Moon Collection

INOX
18/10

- **Cuerpo de acero inoxidable 18/10, resistente a la corrosión.**
- **Diseño elegante y actual.**
- **Muy cómodo y fácil de desplazar gracias a su asa de cuero.**
- **Asa de piel vacuno acabado en curtido vegetal de 3 mm de grosor.**
- **Acabado exterior negro mate e interior lijado.**

- 18/10 corps en acier inoxydable, résistant à la corrosion.
- Conception élégante et actuelle.
- Très confortable et facile à déplacer grâce à sa poignée en cuir.
- Poignée en cuir vide finie en bronzage de légumes de 3 mm d'épaisseur.
- Finition extérieure noire mate et intérieure.

- 18/10 stainless steel body, corrosion resistant.
- Elegant and current design.
- Very comfortable and easy to move thanks to its leather handle.
- Vacune leather handle finished in 3 mm thick vegetable tanning.
- Matte and interior black exterior finish.



Cubitera Moon

Seau à glace · Sektkühler
Ice bucket · Porta-cubos de gelo

| | Ref | € | Ø (cm) | h (cm) | L | U.Venta |
|----------|-------|-------|--------|--------|-----|---------|
| A | 65414 | 41,10 | 14 | 12 | 1,5 | 1 |
| B | 65614 | 35,50 | 14 | 12 | 1,5 | 1 |



Enfriabotellas Moon

Seau à champagne · Champagnerkühler
Wine bucket · Arrefecedora de garrafas

| | Ref | € | Ø (cm) | h (cm) | L | U.Venta |
|----------|-------|-------|--------|--------|-----|---------|
| A | 65418 | 48,70 | 18 | 19,0 | 4,0 | 1 |
| | 65420 | 58,10 | 20 | 19,5 | 5,6 | 1 |
| B | 65618 | 45,00 | 18 | 19,0 | 4,0 | 1 |
| | 65620 | 54,00 | 20 | 19,5 | 5,6 | 1 |



Champanero Moon

Refräichisseur à champagne · Champagnerkühler
Champagne cooler · Champanheiro

| | Ref | € | Ø (cm) | h (cm) | L | U.Venta |
|----------|-------|--------|--------|--------|------|---------|
| A | 65436 | 123,60 | 36 | 20,5 | 11,5 | 1 |
| B | 65636 | 123,60 | 36 | 20,5 | 11,5 | 1 |

Champanero inclinado Moon

Refräichisseur à champagne incliné · Schräger Champagnerkühler
Inclined champagne cooler · Champanheiro inclinado

| | Ref | € | Ø (cm) | h (cm) | L | U.Venta |
|----------|-------|--------|--------|--------|----|---------|
| A | 65440 | 122,30 | 40 | 27 | 15 | 1 |
| B | 65640 | 122,30 | 40 | 27 | 15 | 1 |



Barreño Moon

Bassine · Glatzwanne
Mirror cooler · Bacia

| | Ref | € | Ø (cm) | h (cm) | L | U.Venta |
|----------|-------|--------|--------|--------|----|---------|
| A | 65450 | 108,30 | 50 | 21 | 30 | 1 |
| B | 65650 | 108,30 | 50 | 21 | 30 | 1 |



Enfriabotellas

INOX 18/10
Dishwasher

- Amplia gama de enfriadores de botellas para el vino o champán.
- Fabricados en acero inoxidable de gran calidad.
- Ideal para uso doméstico y profesional.

- Large gamme de rafraîchisseurs de bouteilles pour le vin ou le champagne.
- Fabriqué en acier inoxydable de haute qualité.
- Idéal pour un usage domestique et professionnel.

- Wide range of bottle coolers for wine or champagne.
- Made of high quality stainless steel.
- Ideal for domestic and professional use.

Compatible con:
Compatible with:

- 62315
- 62320
- 62322
- 62321
- 61321
- 61319
- 14121
- 62365
- 62362
- 65418
- 65420
- 65618
- 65620

INOX

Pie porta cubos

Porte-seau à champagne · Sektkühlerständer
Wine cooler stand · Pé porta baldes

| Ref | € | Ø (cm) | h(cm) | U.Venta |
|-------|-------|--------|-------|---------|
| 62300 | 92,50 | 20 | 65 | 1 |



Sujeción segura y estable en cualquier mesa
Secure and stable hold on any table



FE Iron
CRO Cromado Chrome

Soporte de mesa enfriabotellas

Support seu à champagne · Tischhalterung für Sektkühler
Wine cooler table support · Sup. balde de gelo arrefecedor

| Ref | € | Ø (cm) | U.Venta |
|-------|-------|--------|---------|
| 62478 | 13,20 | 18 | 1 |
| 62479 | 13,20 | 20 | 1 |

Anilla de acero inoxidable
Stainless steel ring

Doble pared aislante
Acabado SOFT TOUCH
Double insulating wall
SOFT TOUCH finish



Dishwasher

Enfriabotellas Black

Seau à vin · Champagnerkühler
Vine bucket · Balde enfria-garrafas

| Ref | € | Ø (cm) | Diámetro interior (cm) | h(cm) | U.Venta |
|-------|-------|--------|------------------------|-------|---------|
| 62356 | 17,00 | 12,5 | 9,50 | 20 | 1 |



Apta para la mayoría de las botellas de vino o champán
Fits most bottles of red wine or champagne



Dishwasher

Enfriabotellas Inox

Seau à champagne · Champagnerkühler
Champaing cooler · Arrefecedora de garrafas

| Ref | € | Ø (cm) | h(cm) | U.Venta |
|-------|-------|--------|-------|---------|
| 62389 | 31,90 | 10,5 | 19,5 | 1 |

Doble pared aislante
Double insulating wall



Cubitera

Seau à glace · Sektkühler
Ice bucket · Porta-cubos de gelo

| Ref | € | Ø (cm) | h (cm) | L | U.Venta |
|-------|-------|--------|--------|------|---------|
| 62315 | 32,60 | 14 | 12 | 1,20 | 1 |
| 62320 | 44,30 | 20 | 19 | 4,50 | 1 |
| 62322 | 53,20 | 22 | 20 | 5,50 | 1 |
| 14121 | 19,70 | 20 | 20 | 4,00 | 1 |
| 62321 | 64,80 | 18 | 20 | 5,50 | 1 |
| 61321 | 25,30 | 20 | 21 | 4,25 | 1 |
| 61319 | 27,40 | 20 | 22 | 4,75 | 1 |
| 62338 | 84,30 | 30 | 20 | 7,00 | 1 |



Champanero

Refrâchisseur à champagne · Champagnerkühler
Champagne cooler · Champanheiro

| Ref | € | Ø (cm) | h (cm) | L | U.Venta |
|-------|--------|--------|--------|-------|---------|
| 62336 | 134,80 | 36 | 28,0 | 11,50 | 1 |
| 62436 | 124,60 | 36 | 23,0 | 11,50 | 1 |
| 62439 | 136,00 | 40 | 26,0 | 15,00 | 1 |
| 62346 | 88,40 | 36 | 20,5 | 13,0 | 1 |
| 62271 | 59,80 | 43x30 | 20,0 | 20,00 | 1 |
| 62272 | 72,00 | 53x38 | 25,0 | 27,00 | 1 |
| 62273 | 84,20 | 61x43 | 28,0 | 32,00 | 1 |



Enfriabotellas



Acabado metalizado
Metallic finish



ABS
Plastic

Enfriabotellas Artic

Seau à champagne · Champagnerkühler
Champaing cooler · Arrefecedora de garrafas

| Ref | € | Ø (cm) | h(cm) | L | U.Venta |
|-------|-------|--------|-------|------|---------|
| 61331 | 20,10 | 20 | 25 | 3,50 | 1 |

Enfriabotellas

Seau à champagne · Champagnerkühler
Champaing cooler · Arrefecedora de garrafas

| Ref | € | Base | cm | h(cm) | L | U.Venta |
|---------|-------|-----------|-----------|-------|------|---------|
| A 62364 | 18,50 | 16 | 22x18 | 23 | 3,00 | 1 |
| B 62365 | 34,20 | 13,5x16 | 20,5x25,5 | 28,5 | 4,50 | 1 |
| C 62366 | 41,10 | 13,5x18,5 | 21,5x30,5 | 26 | 5,50 | 1 |



Enfriabotellas Bloom

Seau à champagne · Champagnerkühler
Champaing cooler · Arrefecedora de garrafas

| Ref | € | Ø (cm) | h(cm) | L | U.Venta |
|---------|-------|--------|-------|-------|---------|
| A 62362 | 12,90 | 22 | 21 | 3,50 | 1 |
| B 62371 | 29,60 | 33 | 25 | 10,00 | 1 |

Enfriabotellas Boat Black

Seau à champagne · Champagnerkühler
Champaing cooler · Arrefecedora de garrafas

| Ref | € | Base | cm | h(cm) | L | U.Venta |
|---------|-------|---------|-----------|-------|------|---------|
| A 62354 | 34,30 | 13,5x16 | 20,5x25,5 | 28,5 | 4,00 | 1 |
| B 62367 | 35,60 | 16x12 | 27x20 | 20,0 | 3,00 | 1 |
| B 62368 | 51,40 | 21x15,5 | 35x26,5 | 26,0 | 7,00 | 1 |



Enfriabotellas Bubble

Seau à champagne · Champagnerkühler
Champaing cooler · Arrefecedora de garrafas

| Ref | € | cm | h(cm) | L | U.Venta |
|-------|-------|-------|-------|-------|---------|
| 62373 | 31,10 | 47x29 | 23 | 13,00 | 1 |



Jarras



Tapa con doble posición
Filtro-colador integrado en la tapa (2) el hielo, las hierbas aromáticas o la fruta es retenida en el vertido
Double position lid
Filter-strainer integrated in the lid (2).
Ice, aromatic herbs or fruit is held in place while pouring



Jarra
Pot à eau · Wasserkanne
Water jug · Jarra

| Ref | € | cm | h(cm) | L | U.Venta |
|---------|-------|----------|-------|------|---------|
| A 61952 | 16,60 | 14x9,2 | 27,3 | 1,70 | 1 |
| B 61953 | 15,40 | 13,8x8,5 | 22,8 | 1,00 | 1 |



Jarra Dispensadora
Pichet distributeur de boissons · Getränkespender
Serving pitcher · Jarra dispensadora

| Ref | € | cm | h (cm) | L | U.Venta |
|---------|-------|-------|--------|------|---------|
| A 61951 | 22,80 | 18x23 | 30,5 | 5,50 | 1 |
| B 61955 | 7,90 | 19,5 | 18,5 | - | 1 |
| C 61956 | 13,60 | 21,0 | 14,5 | - | 1 |

- Jarra fabricada en vidrio borosilicato ultrarresistente. Resistente a los choques térmicos.
- Tapa extraíble de acero inoxidable 18/10 diseñada para conseguir un cierre hermético. (fresh).
- Tapa extraíble de fibra de bambú diseñada para conseguir un cierre hermético (Sea).
- Colador integrado: el hielo, las hierbas aromáticas o la fruta es retenida en el vertido.
- Perfecta para bebidas calientes o frías como agua, limonada, té, sangría, leche, etc. Ideal para llevar las bebidas a la mesa o guardarlas en la nevera.
- Diseño moderno y elegante. Mango ergonómico y pico vertedor para evitar derrames.
- Gran apertura que facilita su llenado y su limpieza.
- Apta para el lavavajillas.

- Jug made of ultra -resistant borosilicate glass. Resistant to thermal shocks.
- Removable stainless steel lid 18/10 designed to get a hermetic closure (fresh).
- Couvercle en fibre de bambou amovible conçu pour obtenir une fermeture hermétique (Sea).
- Integrated strainer: ice, aromatic herbs or fruit is retained on the discharge.
- Perfect for hot or cold drinks such as water, lemonade, tea, bleeding, milk, etc. Ideal to bring drinks to the table or save them in the fridge.
- Modern and elegant design. Ergonomic mango and pico to avoid spills.
- Great opening that facilitates its filling and cleaning.
- Suitable for dishwasher.



- Jarra dispensadora fabricada en cristal de máxima calidad.
- Grifo integrado para servir la cantidad de bebida deseada directamente en el vaso. Tapa de acero con cierre hermético.
- Perfecta para bebidas frías como agua, limonada, zumo, sangría, etc. Ideal para buffet, área de reuniones, recepciones de hoteles, etc.
- Gran apertura que facilita su llenado y su limpieza. Capacidad de 5,5 L.
- Jarra apta para el lavavajillas.

- Dispenser jug made of maximum quality crystal.
- Integrated tap to serve the amount of drink desired directly in the glass. Steel lid with airtight closure.
- Perfect for cold drinks such as water, lemonade, juice, bleeding, etc. Ideal for buffet, meetings area, hotels receptions, etc.
- Great opening that facilitates its filling and cleaning. Capacity of 5.5 L.
- Jug suitable for dishwasher.





- Cuerpo fabricado en plástico y tapa en polipropileno.
- Libre de bpa.
- Tapa antiderrames para verter sin ningún problema.
- Filtro infusor en el centro para frutas y verduras.
- Fácil de usar y perfecta para un estilo de vida saludable.

- Corps en plastique et couvercle en polypropylène.
- Sans BPA.
- Couverture antiderram à verser sans aucun problème.
- Filtre de perfusion dans le centre des fruits et légumes.
- Facile à utiliser et parfait pour un mode de vie sain.

- Body made of plastic and lid in polypropylene.
- BPA free.
- Antiderram cover to pour without any problem.
- Infusionary filter in the fruits and vegetable center.
- Easy to use and perfect for a healthy lifestyle.



PP
Polypropylene
Dishwasher
BPA free

Jarra Infusora Clear
Pichet infuseur · Tee-Zubereiter
Infusion pitcher · Jarra infusionadora

| Ref | € | cm | L | U.Venta |
|-------|-------|----------|------|---------|
| 61954 | 31,60 | 19x16x29 | 2,40 | 1 |

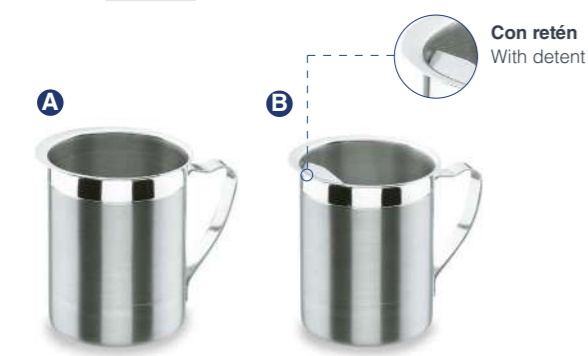

Con retén
With detent

INOX
18/10

Jarra de agua Inox
Pot à eau · AcrylKrug
Water pitcher · Jarra

| Ref | € | Ø (cm) | L | U.Venta |
|-------|-------|---------|------|---------|
| 62716 | 26,00 | 12x16 | 1,50 | 1 |
| 62721 | 28,70 | 12x23 | 2,00 | 1 |
| 62726 | 33,10 | 12x26,5 | 2,50 | 1 |
| 62715 | 30,20 | 12x16 | 1,50 | 1 |
| 62720 | 31,50 | 12x23 | 2,00 | 1 |
| 62725 | 35,60 | 12x26,5 | 2,50 | 1 |

Jarra de agua abombada
Pot à eau bombée · Wasserkanne
Rounder water pitcher · Jarra bojuda

| Ref | € | L | U.Venta |
|-------|-------|------|---------|
| 62702 | 49,20 | 2,00 | 1 |

ASA
Acrylic
Dishwasher
BPA free

Jarra de agua Clear
Pot à eau · AcrylKrug
Water pitcher · Jarra

| Ref | € | L | U.Venta |
|-------|-------|------|---------|
| 62392 | 14,30 | 2,00 | 1 |
| 62393 | 18,10 | 3,00 | 1 |

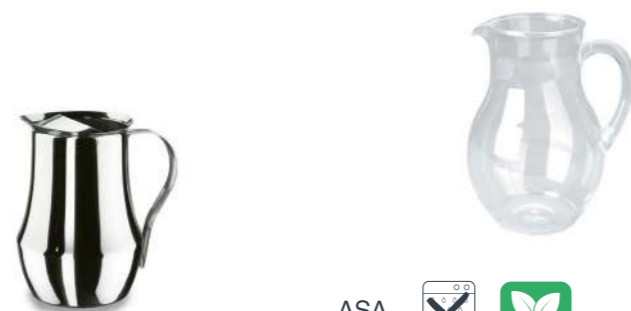

Vasos



Dishwasher

- Fabricados en tritán transparente libre de BPA; material muy resistente que soporta altas temperaturas.
- Ligeros, versátiles y a prueba de roturas, perfectos para espacios exteriores donde la seguridad es importante.
- Para servir y disfrutar todo tipo de bebidas en cualquier ocasión.
- Su gran parecido visual al vidrio hace que sea sutil, elegante y de calidad, como un vaso de vidrio.
- Reutilizables, irrompibles.

- Fabriqué dans un Tritán transparent sans BPA; Matériau très résistant qui prend en charge des températures élevées.
- Proof léger, polyvalent et brisé, parfait pour les espaces extérieurs où la sécurité est importante.
- Servir et profiter de toutes sortes de boissons à n'importe quelle occasion.
- Sa grande ressemblance visuelle avec le verre le rend subtil, élégant et de qualité, comme un verre en verre.
- Réutilisable, incassable.

- Manufactured in transparent tritán free of BPA; Very resistant material that supports high temperatures.
- Light, versatile and breakage proof, perfect for outdoor spaces where security is important.
- To serve and enjoy all kinds of drinks on any occasion.
- Its great visual resemblance to glass makes it subtle, elegant and quality, like a glass glass.
- Reusable, unbreakable,



TRITAN
Plastic
BPA free

Set 6 vasos Tritán

Set 6 verres · Set 6 gläser
Set of 6 glasses · Conjunto de 6 copos

| | Ref | € | ml | Ø (cm) | h(cm) | U.Venta | |
|---|-------|-------|-----|--------|-------|---------|------------------------------|
| A | 63141 | 33,90 | 400 | 8,5 | 9,5 | 1 | Whisky · Whisky |
| B | 63143 | 46,50 | 350 | 7 | 20 | 1 | Vino blanco · White wine |
| C | 63144 | 52,80 | 500 | 9,5 | 21 | 1 | Vino tinto · Red wine |
| D | 63146 | 63,60 | 500 | 8,5 | 14 | 1 | Cerveza · Beer |
| E | 63147 | 50,20 | 350 | 8,0 | 10 | 1 | Agua · Water |
| F | 63148 | 36,00 | 300 | 6,5 | 11 | 1 | Vaso para niño · Child glass |
| G | 63149 | 52,40 | 150 | 4,5 | 22,5 | 1 | Champán · Champagne |

MF
Melamine
BPA free

Vaso Melamina
Timbale · Trinkbecher
Tumbler · Copo

| | Ref | € | L | Ø (cm) | h(cm) | U.Venta |
|---|-------|------|------|--------|-------|---------|
| A | 63350 | 3,50 | 0,32 | 7,3 | 7,7 | 1 |
| B | 63351 | 3,50 | 0,32 | 7,3 | 7,7 | 1 |

INOX
18/10
Dishwasher

Vaso Inox
Timbale · Trinkbecher
Tumbler · Copo

| | Ref | € | L | Ø (cm) | h (cm) | U.Venta |
|--|-------|------|------|--------|--------|---------|
| | 62406 | 6,20 | 0,30 | 7,5 | 10,0 | 1 |

Soporte Copas

FE CRO
Iron Cromado
Chrome

- Soporte que permite ahorrar espacio y almacenar las copas de forma ordenada.
- Se fija a la parte superior de un mueble, techo o cornisa permitiendo colocar las copas boca abajo y facilitando accesibilidad de las mismas.
- Desliza las copas muy fácilmente evitando que se marquen y que se rompan.

- Support qui permet d'économiser de l'espace et de stocker les lunettes de manière ordonnée.
- Il est fixé au sommet d'un mobilier, d'un toit ou d'une corniche permettant de placer les verres face vers le bas et de faciliter leur accessibilité.
- Faites glisser les verres qui les empêchaient très facilement d'être marqués et se briser.

- Support that allows saving space and storing the glasses in an orderly manner.
- It is fixed to the top of a furniture, roof or cornice allowing to place the glasses face down and facilitating their accessibility.
- Slide the glasses very easily preventing them from being marked and breaking.

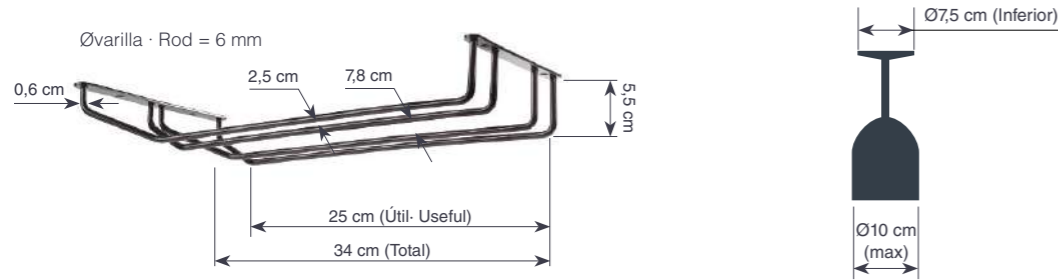

Soporte de copas Inox

Support à coupes · Gläserhalter
Cups stand · Suporte de tapas

| | Ref | € | cm | h(cm) | U.Venta |
|----------|-------|-------|-------|-------|---------|
| A | 62261 | 15,30 | 34x10 | 6 | 1 |
| B | 62262 | 22,40 | 34x20 | 6 | 1 |
| C | 62263 | 34,40 | 34x40 | 6 | 1 |



Soporte de Copas Black

Support à coupes · Gläserhalter
Cups stand · Suporte de tapas

| | Ref | € | cm | h(cm) | U.Venta |
|----------|-------|-------|-------|-------|---------|
| A | 62264 | 17,80 | 34x10 | 6 | 1 |
| B | 62265 | 27,30 | 34x20 | 6 | 1 |
| C | 62266 | 38,40 | 34x40 | 6 | 1 |



No requiere instalación
Recubrimiento de silicona, no raya
No installation required
Silicone coating, does not scratch

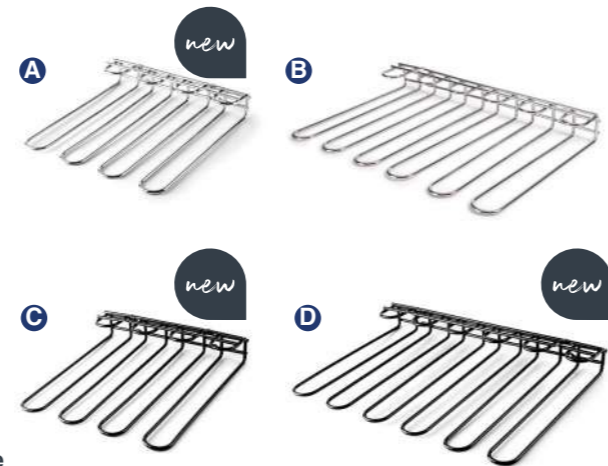

Soporte de copas Due

Support à coupes · Gläserhalter
Cups stand · Suporte de tapas

| | Ref | € | cm | h(cm) | Capacidad | U.Venta |
|----------|-------|-------|---------|-------|-----------|---------|
| A | 62254 | 12,30 | 29x31,5 | 5,0 | 12 copas | 1 |
| B | 62268 | 19,20 | 45x32 | 6,0 | 20 copas | 1 |
| C | 62253 | 12,30 | 29x31,5 | 5,00 | 12 copas | 1 |
| D | 62255 | 19,20 | 45x32 | 6,00 | 20 copas | 1 |

Soporte de copas Tri

Support à coupes · Gläserhalter
Cups stand · Suporte de tapas

| | Ref | € | cm | Capacidad | U.Venta |
|--|-------|-------|-------|-----------|---------|
| | 62267 | 18,60 | 31x21 | 6 copas | 1 |



Coctelería

INOX 18/10 INOX PP
Polypropylene Dishwasher BPA free

- Todo lo necesario para preparar deliciosos cócteles.
- Ideal para profesionales de la coctelería.
- Podrá encontrar cocteleras, pinzas para hielo, vasos medidores, cucharas de bar, etc.

- Tout ce dont vous avez besoin pour préparer de délicieux cocktails.
- Idéal pour les mixologues professionnels.
- Vous pouvez trouver des shakers, pinces à glace, verres à mesurer, cuillères de bar, etc.

- Everything you need to prepare delicious cocktails.
- Ideal for professional mixologists.
- You can find cocktail shakers, ice tongs, measuring glasses, bar spoons, etc.

Compuesto por:

- A** Cucharilla cocktail
- B** Coctelera
- C** Maza mojito
- D** Colador gusanillo
- E** Sacacorchos
- F** Dosificador licor
- G** Pinza
- H** Tapón
- I** Dos boquillas servidoras
- J** Soporte

Compuesto por:

- A** Cucharilla cocktail
- B** Coctelera
- C** Maza mojito
- D** Colador gusanillo
- E** Pinza
- F** Dosificador licor
- G** Dos boquillas servidoras



Juego coctelería Inox

Ensemble pour cocktails · Cocktail-Utilensilien
Cocktail Set · Conjunto para preparar cocktails

| Ref | € | Piezas | U.Venta |
|-------|-------|--------|---------|
| 62181 | 61,40 | 10 | 1 |

TPE Plastic Dishwasher

Tapete para coctelería

Tapis pour égouttoir · Cocktail-Matte
Cocktail mat · Tapete para cocktails

| | Ref | € | cm | h(cm) | U.Venta |
|----------|-------|-------|-------|-------|---------|
| A | 62626 | 17,90 | 45x30 | 1,80 | 20 |
| B | 62627 | 11,00 | 30x15 | 1,80 | 20 |
| C | 62628 | 11,00 | 60x8 | 1,80 | 20 |

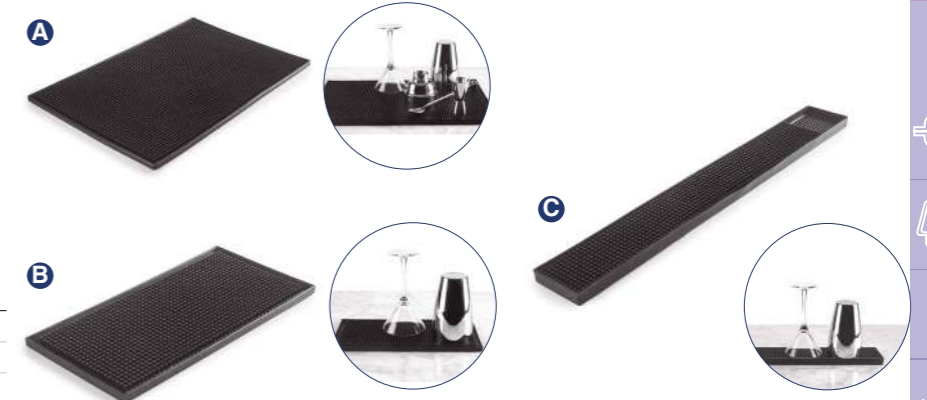

Juego coctelería Inox cobre

Ensemble pour cocktails · Cocktail-Utilensilien
Cocktail Set · Conjunto para preparar cocktails

| Ref | € | Piezas | U.Venta |
|-------|-------|--------|---------|
| 62182 | 57,50 | 8 | 1 |



Perfecto para organizar utensilios y accesorios de coctelería y bar como servilletas, pajitas, adornos, etc. Puede contener aproximadamente 100 servilletas de 12x12 cm
 Perfect for organising cocktail utensils and accessories and bar such as napkins, straws and decorations. It holds around 100 12x12 cm cocktail napkins.



6
Compart.

ABS
Plastic
Dishwasher

Organizador de accesorios cóctel

Organisateur pour accessoires de cocktail · Organizer für Cocktailzubehör
 Cocktail accessory organiser · Organizador de acessórios para cocktails

| Ref | € | cm | h(cm) | Compartimentos | U.Venta |
|-------|------|-------|-------|----------------|---------|
| 62438 | 9,70 | 24x14 | 10 | 6 | 1 |

Diseno Vintage



A

B

INOX
18/10
Dishwasher

Taza Moscow Mule

Tasse · Tassen
 Cup · Copo

| Ref | € | ml | Ø (cm) | h(cm) | U.Venta |
|----------------|-------|-----|--------|-------|---------|
| A 62184 | 10,30 | 480 | 9 | 9 | 1 |
| B 62185 | 10,30 | 550 | 9 | 10 | 1 |

INOX
18/10
Dishwasher

Vaso Julep Mug

Timbale · Trinkbecher
 Tumbler · Copo

| Ref | € | ml | h(cm) | U.Venta |
|-------|-------|-----|-------|---------|
| 62187 | 10,30 | 350 | 10 | 1 |

Ideal para dar un toque especial a los cócteles. Consigue un efecto de hielo o escarcha
 Perfect for adding a special touch to your cocktails. Create a frosty or icy effect.

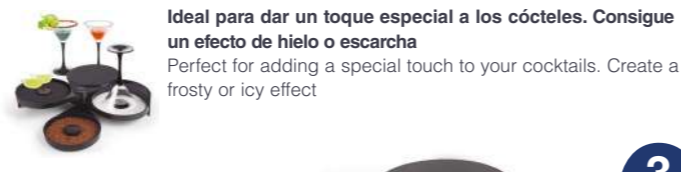

3
Compart.

Almohadilla para zumo
 Pad for juice

ABS
Plastic
Dishwasher

Ribeteador de copas y vasos

Sucreur/saleur bordeur de verres · Umranden für Cocktailgläser
 Glass rimmer · Decorador de copos e taças

| Ref | € | cm | h(cm) | Bandejas | U.Venta |
|-------|-------|-------|-------|----------|---------|
| 62414 | 14,30 | 20x16 | 7,5 | 3 | 1 |

- Fabricadas en acero inoxidable 18/10 de alta calidad.
- Revestimiento exterior cobre mate.
- Ideal para preparar el clásico cóctel de vodka "Moscow Mule", (62184/62185), cóctel de menta "Mint Juel" (62187), cócteles o cualquier tipo de bebida frías.
- Mantiene las bebidas frías por más tiempo gracias a su alta conductividad térmica.
- Borde de acero encapsulado reforzado.
- Mango ergonómico fabricado en acero inoxidable (62184/62185).
- Fácil limpieza: Se recomienda lavar a mano y secar a fondo. No apto para el lavavajillas.

- Fabriquée en acier inoxydable 18/10 de grande qualité.
- Revêtement extérieur en cuivre mat.
- Idéales pour préparer le traditionnel cocktail de menthe « Moscow Mule », (62184/62185), cocktail de menthe « Mint Juel », (62187), ainsi que tout type de cocktail ou de boisson froide.
- Gardent les boissons fraîches plus longtemps.
- Bord en acier encapsulé renforcé.
- Poignée ergonomique en acier inoxydable (62184/62185).
- Nettoyage facile : Il est recommandé de les laver à la main et de parfaitement bien les sécher. Ne pas mettre au lave-vaisselle.

- Made of high quality 18/10 stainless steel.
- Matte copper outer finish.
- Perfect for making the classic "Moscow Mule" vodka cocktail (62184/62185), Mint Juel mint cocktail (62187), other cocktails or any kind of cold drink.
- Keeps drinks cold longer because of their high thermal conductivity.
- Reinforced encapsulated steel edge. Ergonomic handle made of stainless steel.
- Ergonomic handle made of stainless steel (62184/62185).
- Easy to clean: Hand washing and thorough drying is recommended. Not dishwasher safe.



INOX
VIDRIO
Glass
Dishwasher

Coctelera Boston

Agitateur · Cocktailshaker
 Cocktail shaker · Agitador

| Ref | € | Ø (cm) | h(cm) | U.Venta |
|----------------|-------|--------|-------|---------|
| A 62285 | 14,30 | 8 | 16 | 1 |
| B 62286 | 18,70 | 8 | 16 | 1 |



INOX
18/10
ASA
Acrylic
Dishwasher
BPA free

Coctelera Acrylic

Agitateur · Cocktailshaker
 Cocktail shaker · Agitador

| Ref | € | Ø (cm) | h(cm) | ml | U.Venta |
|-------|-------|--------|-------|-----|---------|
| 62388 | 21,20 | 9 | 22,5 | 450 | 1 |



INOX
18/10
BAMBOO
Dishwasher

Cubitera Nordic

Seau à glace · Sektkühler
 Ice bucket · Porta-cubos gelo

| Ref | € | Ø (cm) | h(cm) | L | U.Venta |
|-------|-------|--------|-------|------|---------|
| 65514 | 32,90 | 14 | 14,5 | 1,30 | 1 |



Librador Inox

Pelle à farine · Mehlshaufel
 Ice shovel · Corredor

| Ref | € | ml | Largo (cm) | Ancho (cm) | U.Venta |
|-------|-------|-----|------------|------------|---------|
| 67012 | 17,90 | 60 | 19,0 | 5,0 | 6 |
| 67013 | 20,80 | 110 | 21,5 | 6,0 | 6 |
| 67014 | 24,60 | 200 | 24,0 | 7,0 | 6 |
| 67016 | 27,30 | 260 | 25,5 | 8,5 | 1 |
| 67017 | 30,30 | 360 | 29,0 | 10,0 | 6 |
| 67018 | 32,70 | 470 | 31,0 | 11,0 | 6 |
| 67019 | 40,70 | 640 | 35,0 | 12,5 | 6 |
| 67020 | 48,70 | 860 | 38,0 | 14,0 | 6 |



Coctelera Inox

Agitateur · Cocktailshaker
 Cocktail shaker · Agitador

| Ref | € | L | U.Venta |
|--------|-------|------|---------|
| 623031 | 52,20 | 0,50 | 1 |
| 623041 | 61,90 | 0,75 | 1 |



INOX
18/10
Dishwasher
BPA free

Picadora de hielo manual

Broyeur à glace manuel · Manuel Eis-Crusher
 Manual ice crusher · Picadora de gelo manual

| Ref | € | cm | h(cm) | U.Venta |
|-------|-------|-------|-------|---------|
| 60327 | 50,60 | 16x23 | 12 | 1 |



ASA
Acrylic
Dishwasher
BPA free

Cubitera Clear

Seau à glace · Sektkühler
 Ice bucket · Porta-cubos gelo

| Ref | € | Ø (cm) | h(cm) | L | U.Venta |
|-------|-------|--------|-------|------|---------|
| 62363 | 26,50 | 20 | 21 | 3,00 | 1 |



PC
Polycarbonate
Dishwasher
BPA free

Librador

Pelle à farine · Mehlshaufel
 Ice shovel · Corredor

| Ref | € | ml | U.Venta |
|----------------|-------|------|---------|
| A 67021 | 5,90 | 170 | 1 |
| B 67022 | 11,90 | 900 | 1 |
| C 67023 | 16,30 | 1800 | 1 |





Pinza de hielo Nord

Pince à glace · Eiszange
Ice tong · Pinça de gelo

| Ref | € | Largo (cm) | U.Venta |
|-------|------|------------|---------|
| 62306 | 4,70 | 18,5 | 12 |



Pinza de hielo Luxe

Pince à glace · Eiszange
Ice tong · Pinça de gelo

| Ref | € | Largo (cm) | U.Venta |
|-------|-------|------------|---------|
| 62337 | 10,20 | 20 | 12 |



Colador gusanillo

Passoire à cocktail · Cocktailsieb
Cocktail strainer · Coador batidos

| Ref | € | Ø (cm) | U.Venta |
|-------|-------|--------|---------|
| 62326 | 24,20 | 7,5 | 1 |



PP
Polypropylene
BPA free

Maza negra mojito

Pilon noir mojito · Mojitostößel
Black mace mojito · Maço preto mojito

| Ref | € | Largo (cm) | U.Venta |
|-------|-------|------------|---------|
| 62278 | 11,50 | 18 | 1 |
| 62279 | 13,00 | 26 | 1 |



Cucharilla Coctail

Cuillère cocktail · Barlöffel
Cocktail spoon · Colher cocktail

| Ref | € | Largo (cm) | U.Venta |
|---------|------|------------|---------|
| A 62302 | 4,80 | 27 | 6 |
| B 62352 | 8,30 | 28 | 6 |

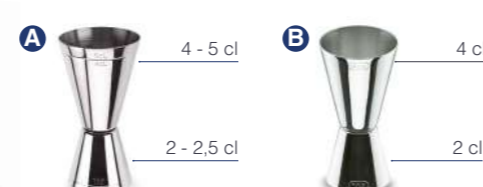

Dosificador licor Dual

Mesure à cocktail · Cocktailmass
Jigger · Dosificador licor

| Ref | € | cl | h(cm) | U.Venta |
|---------|-------|-------------|-------|---------|
| A 62329 | 22,40 | 2-2,5 / 4-5 | 9,7 | 1 |
| B 62330 | 20,60 | 2 / 4 | 9,7 | 1 |

Vinoteca



INOX

Descapsulador Rond

Coupe capsule · Folien cutter
Foil cutter · Descapsulador

| Ref | € | Ø (cm) | U.Venta |
|-------|------|--------|---------|
| 63137 | 4,90 | 6 | 12 |



INOX

Anilla antigoteo

Anneau stop gouttes à vin · Weinring Trop-Stop
Wine drip stop ring · Anilha anti-gota

| Ref | € | Ø (cm) | U.Venta |
|-------|------|--------|---------|
| 63019 | 3,20 | 5 | 12 |



INOX

SI
Silicone



Boquilla servidora + tapón

Bec verseur + bouchon · Ausgiess-Aufsatz mit Verschluss
Spout for wine + rubber cap · Boquilha de servir + tampão

| Ref | € | U.Venta |
|-------|------|---------|
| 63022 | 4,50 | 12 |



SI
Silicone



Aireador de vino

Aérateur de vin · Weinbelüfter
Wine aerator · Arejador de vinho

| Ref | € | U.Venta |
|-------|------|---------|
| 63048 | 2,90 | 1 |



Dispensador de líquidos Bar-Butler

Distributeur de boissons alcoolisées · Spirituosenspender
Liquor dispenser · Dispensador de bebidas

| Ref | € | L | U.Venta |
|-------|-------|------|---------|
| 62341 | 95,20 | 4 cl | 1 |



Botella sifón CO2

Bouteille siphon · Soda-Siphon
Soda maker bottle · Garrafa armadilha

| Ref | € | Ø (cm) | L | U.Venta |
|-------|-------|--------|------|---------|
| 68601 | 56,40 | 10x39 | 1,00 | 1 |



Cargas para botellas sifón CO2

Cartuches CO2 pour siphon · CO2-Kapsen für Siphon
CO2 soda charges · Botijas de sifão CO2

| Ref | € | Botellas | g | U.Venta |
|-------|------|----------|---|---------|
| 68602 | 8,20 | 10 | 8 | 1 |



Conserva durante más tiempo el frescor y el sabor del champán o cava
Conserve the freshness and flavour of Champagne or Cava for longer

PP
Polypropylene

INOX



Tapón champán

Bouchon de champagne · Sektflaschenverschluss
Campagne cap · Tampão champagne

| Ref | € | Ø (cm) | h(cm) | U.Venta |
|---------|------|--------|-------|---------|
| A 63021 | 7,30 | 4,5 | 4,5 | 1 |
| B 63055 | 8,20 | 3,8 | 3,5 | 1 |



Inox

Copper



Bloqueo rotativo
Rotary lock

Sacacorchos



- **Diseño elegante, moderno y ergonómico: ideal para su uso profesional y de hogar.**
- **Funcionamiento rápido y sencillo tan solo pulsando un botón.**
- **Facilita la extracción del corcho de cualquier botella de vino en tan solo 6-8 segundos.**
- **Extrae el corcho suavemente y de forma silenciosa.**
- **Cabezal de extracción con iluminación led.**
- **Indicador de batería luminoso mediante LED: 4 niveles para indicar el nivel de energía.**
- **Se carga mediante cable Micro USB.**
- **Incluye: cable cargador USB y descapsulador.**

- Design élégant, moderne et ergonomique: idéal pour un usage professionnel et à domicile.
- Fonctionnement rapide et simple simplement en appuyant sur un bouton.
- Il facilite l'extraction du bouchon de n'importe quelle bouteille de vin en seulement 6 à 8 secondes.
- Extraire le liège doucement et silencieusement.
- Tête d'extraction avec éclairage LED.
- Indicateur de batterie LED Utilisation de LED: 4 niveaux pour indiquer le niveau d'énergie.
- Il est chargé par un câble micro USB.
- Comprend: câble de chargeur USB et décapsules.

- Elegant, modern and ergonomic design: ideal for professional and home use.
- Fast and simple operation just by pressing a button.
- It facilitates the extraction of the cork of any wine bottle in just 6-8 seconds.
- Extract the cork gently and silently.
- Extraction head with LED lighting.
- LED battery indicator using LED: 4 levels to indicate the energy level.
- It is loaded by micro USB cable.
- Includes: USB charger cable and decapsulator.



Autonomía
Battery life
30-40
Botellas
Bottles



Sacacorchos eléctrico Black Luxe

Tire bouchon électrique · Korkenzieher, elektrisch
Electric corkscrew · Saca-rolhas eléctrico

| Ref | € | Ø (cm) | h(cm) | U.Venta |
|-------|-------|--------|-------|---------|
| 63056 | 39,30 | 4,8 | 22 | 1 |



Autonomía
Battery life
30-40
Botellas
Bottles



Sacacorchos eléctrico Black

Tire bouchon électrique · Korkenzieher, elektrisch
Electric corkscrew · Saca-rolhas eléctrico

| Ref | € | Ø (cm) | h(cm) | U.Venta |
|-------|-------|--------|-------|---------|
| 63057 | 30,40 | 5 | 19 | 1 |



Autonomía
Battery life
30
Botellas
Bottles



Sacacorchos eléctrico AutoPro

Tire bouchon électrique · Korkenzieher, elektrisch
Electric corkscrew · Saca-rolhas Eléctrico

| Ref | € | cm | U.Venta |
|-------|-------|--------|---------|
| 63031 | 41,80 | Ø12x32 | 1 |



Autonomía
Battery life
30-40
Botellas
Bottles



Sacacorchos eléctrico Smart

Tire bouchon électrique · Korkenzieher, elektrisch
Electric corkscrew · Saca-rolhas Eléctrico

| Ref | € | cm | U.Venta |
|-------|-------|-------|---------|
| 63054 | 44,90 | Ø5x25 | 1 |



Sacacorchos profesional Automatic

Tire-bouchon professionnel · Profi-Entkorker
Professional corkscrew · Saca-rolhas professional

| Ref | € | U.Venta |
|---------|--------|---------|
| A 63010 | 333,10 | 1 |
| B 63012 | 346,60 | 1 |



ZAMAK
Zinc Alloy

Sacacorchos Black

Tire-bouchon · Korkenzieher
Zinc alloy corkscrew · Saca-rolhas

| Ref | € | U.Venta |
|-------|-------|---------|
| 63028 | 47,10 | 1 |



ZAMAK
Zinc Alloy

Sacacorchos Vin

Tire-bouchon · Korkenzieher
Zinc alloy corkscrew · Saca-rolhas

| Ref | € | U.Venta |
|-------|-------|---------|
| 63013 | 17,80 | 1 |



ZAMAK
Zinc Alloy

Sacacorchos Classic

Tire-bouchon · Korkenzieher
Zinc alloy corkscrew · Saca-rolhas

| Ref | € | U.Venta |
|-------|-------|---------|
| 63047 | 10,30 | 1 |

Multifunción 3 en 1:
sacacorchos + abridor de botellas
+ cuchilla corta cápsulas
Multi-purpose: 3 in 1:
corkscrew + bottle opener+ capsule cutter



INOX

Sacacorchos camarero Duo

Tire-bouchon limonadier · Kellnerkorkenzieher
Waiter's corkscrew · Saca-rolhas con navalha

| Ref | € | U.Venta |
|-------|------|---------|
| 63018 | 5,40 | 6 |



Multifunción 3 en 1
Multi-purpose: 3 in 1

INOX

Sacacorchos camarero Luxe

Tire-bouchon limonadier · Kellnerkorkenzieher
Waiter's corkscrew · Saca-rolhas con navalha

| Ref | € | U.Venta |
|-------|------|---------|
| 63044 | 5,20 | 1 |



Multifunción 3 en 1
Multi-purpose: 3 in 1

INOX

Sacacorchos camarero Madera

Tire-bouchon limonadier · Kellnerkorkenzieher
Waiter's corkscrew · Saca-rolhas con navalha

| Ref | € | U.Venta |
|-------|------|---------|
| 63046 | 7,70 | 1 |



INOX
RUBBER WOOD
Acabado en mate negro
Matte black finish

Bomba de vacío



- Conserva el vino en perfecto estado manteniendo todo su sabor y aroma durante más tiempo.
- Extrae el aire acumulado en el interior de la botella y retrasa el proceso de oxidación.
- Cierra la botella con el tapón y bombea de 10 a 20 veces (dependiendo de la cantidad de vino que haya dentro de la botella) para establecer el vacío.
- Incluye bomba de vacío y dos tapones (con indicador de la fecha en la que se ha sellado la botella).

- Gardez le vin en parfait état en gardant toute sa saveur et son arôme plus longtemps.
- Extraire l'air accumulé à l'intérieur de la bouteille et retarder le processus d'oxydation.
- Fermez la bouteille avec le capuchon et pompez 10 à 20 fois (selon la quantité de vin à l'intérieur de la bouteille) pour établir le vide.
- Comprend une pompe à vide et deux capuchons (avec indicateur de la date à laquelle la bouteille a été scellée).

- Keep the wine in perfect condition keeping all its flavor and aroma for a longer time.
- Extract the accumulated air inside the bottle and delay the oxidation process.
- Close the bottle with the cap and pump 10 to 20 times (depending on the amount of wine inside the bottle) to establish the void.
- Includes vacuum pump and two caps (with indicator of the date on which the bottle has been sealed).

PP
Polypropylene

Bomba de vacío Keep
Pompe à vide · Weinpumpe
Vacuum pump · Bomba de vacío

| Ref | € | U.Venta |
|-----------|------|---------|
| 63051 | 9,10 | 1 |
| A R63051A | 2,40 | 1 |

INOX SI ABS
Stainless Steel Silicone Plastic

Bomba de vacío Inox
Pompe à vide · Weinpumpe
Vacuum pump · Bomba de vacío

| Ref | € | U.Venta |
|----------|-------|---------|
| 63033 | 11,50 | 1 |
| A R63033 | 3,20 | 1 |

Vitrinas expositoras



Protección contra posibles contaminaciones
Protection against food contaminants



Tapa Roll-Top (Plegable)
Roll-Top Lid (Folding)

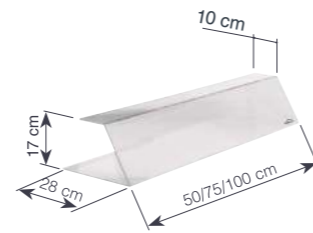

ASA
Acrylic



Vitrina expositora Bar

Vitrine de présentation pour bar · Tisch-Vitrine Gaststätte
Bar display Case · Vitrina expositora para bar

| Ref | € | cm | e (mm) | U.Venta |
|-------|--------|-----------|--------|---------|
| 39450 | 58,20 | 50x28x17 | 5 | 1 |
| 39445 | 86,10 | 75x28x17 | 5 | 1 |
| 39441 | 122,10 | 100x28x17 | 5 | 1 |

PC
Polycarbonate



Tapa expositora GN 1/1

Couvercle de présentation GN 1/1 · Rolltop-Haube
GN 1/1 display Case Lid · Expositor com tampa GN 1/1

| Ref | € | cm | GN | U.Venta |
|--------|-------|---------|--------|---------|
| 66907P | 37,70 | 53x32,5 | GN 1/1 | 1 |

Un total de 5 modelos de vitrinas neutras, calientes y refrigeradas, diseñadas especialmente para presentar y exponer todo tipo de alimentos, y garantizando siempre la calidad y conservación de estos.

There are 5 models of neutral, warm and refrigerated display cases especially designed to present and display all kinds of food and ensure its quality and conservation at all times.



- Vitrina neutra construida íntegramente en cristal y base de acero inoxidable.
- Diseñada para presentar y exponer sobre la barra / mostrador.
- Superficie superior curvada para una visión panorámica.
- Estante intermedio de cristal templado.
- Puerta trasera abatible.
- 4 pies de goma que garantizan máxima estabilidad.

- Vitrine neutre construite entièrement dans une base en verre et en acier inoxydable.
- Conçu pour présenter et exposer sur la barre / comptoir.
- Surface supérieure incurvée pour une vue panoramique.
- Étagère en verre trempé intermédiaire.
- Porte arrière pliante.
- 4 pieds en caoutchouc qui garantissent une stabilité maximale.

- Neutral showcase built entirely in glass and stainless steel base.
- Designed to present and expose on the bar / counter.
- Curved upper surface for a panoramic view.
- Intermediate tempered glass shelf.
- Folding rear door.
- 4 rubber feet that guarantee maximum stability.

CRISTAL INOX
Glass

Vitrina neutra

Vitrine neutre · Einfache vitrine
Clear countertop display case · Vitrina neutra

| Ref | € | Capacidad | h(cm) | Medidas | U.Venta |
|-------|--------|-----------|-------|---------------|---------|
| 69601 | 293,10 | 45L | 37 | 56x37,6x37 cm | 1 |



Parte trasera. Puertas traseras abatibles
Back side. Hinged rear doors



Vitrinas expositoras



IPX4

- Vitrina térmica fabricada en acero inoxidable y cristal.
- Diseñada para conservar, presentar y exponer sobre la barra / mostrador.
- Puerta trasera abatible.
- Superficie superior inclinada para una visión panorámica.
- Recipiente de agua extraíble que aporta humedad en la cámara.
- Termostato de control de temperatura regulable: 30-90°C.
- Bandeja de rejilla extraíble que facilita el lujo del calor.

- Vitrine thermique fabriquée en acier inoxydable et en verre.
- Conçu pour conserver, présenter et exposer sur la barre / comptoir.
- Porte arrière pliante.
- Supérieur submergé pour une vue panoramique.
- Récipient d'eau amovible qui apporte l'humidité dans la chambre.
- Thermostat de commande de température réglable: 30-90°C.
- Plateau de grille amovible qui facilite le luxe de la chaleur.

- Thermal showcase manufactured in stainless steel and glass.
- Designed to conserve, present and expose on the bar / counter.
- Folding rear door.
- Superior overwhelmed for a panoramic view.
- Removable water container that brings moisture in the chamber.
- Adjustable temperature control thermostat: 30-90°C.
- Removable grid tray that facilitates the luxury of heat.

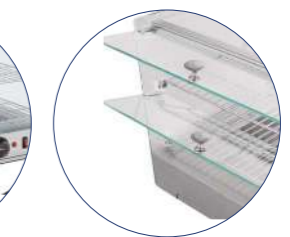

Parte trasera. Puertas traseras abatibles
Back side. Hinged rear doors

CRISTAL INOX
Glass

Vitrina térmica

Vitrine thermique · Warmhaltevitrine
Thermal display case · Vitrina térmica

| Ref | € | W | Capacidad | Temperatura | Protección | Medidas | U.Venta |
|-------|--------|-----|-----------|-------------|------------|-----------------|---------|
| 69604 | 592,80 | 800 | 45L | 30°C-90°C | IPX4 | 55,5x37,5x37 cm | 1 |



4
Cubetas
Containers

- Vitrina térmica fabricada en acero inoxidable y cristal.
- Diseñada para conservar, presentar y exponer sobre la barra / mostrador.
- Puertas correderas para una accesibilidad total.
- Superficie superior curvada para una visión panorámica.
- Cubetas gastronorm 1/3 incluidas.
- Termostato de control de temperatura regulable: 30 - 90°C.

- Vitrine thermique fabriquée en acier inoxydable et en verre.
- Conçu pour conserver, présenter et exposer sur la barre / comptoir.
- Portes coulissantes pour l'accessibilité totale.
- Superficie supérieure incurvée pour une vue panoramique.
- Cubetas Gastronorm 1/3 inclus.
- Thermostat de commande de température réglable: 30 - 90 ° C.

- Thermal showcase manufactured in stainless steel and glass.
- Designed to conserve, present and expose on the bar / counter.
- Sliding doors for total accessibility.
- Superficie Curvada superior for a panoramic view.
- Gastronorm 1/3 trays included.
- Adjustable temperature control thermostat: 30 - 90°C.



IPX4

Parte trasera.
Puertas traseras correderas.
4 / 6 cubetas gastronorm 1/3 incluidas
Back side.
Sliding rear doors.
4/6 Gastronorm 1/3 trays included

INOX CRISTAL
Glass

Vitrina térmica GN

Vitrine thermique · Warmhaltevitrine
Thermal display case · Vitrina térmica

| | Ref | € | W | Capacidad | Temperatura | Protección | Medidas | U.Venta |
|---|-------|--------|-----|-----------|-------------|------------|-----------------|---------|
| A | 69602 | 653,60 | 500 | 4x GN 1/3 | 30°C-90°C | IPX4 | 77,5x42x33,5 cm | 1 |
| B | 69603 | 751,40 | 800 | 6x GN 1/3 | 30°C-90°C | IPX4 | 113x42x33,5 cm | 1 |



Parte trasera
Back side



- Vitrina refrigerada construida íntegramente en cristal y acero inoxidable.
- Diseñada para conservar, presentar y exponer sobre la barra / mostrador.
- Puertas correderas para una accesibilidad total.
- Superficie superior inclinada para una visión panorámica.
- Sistema de enfriamiento por compresor. Función Defrost.
- Termostato de control de temperatura regulable: 2-12°C.
- Sist. de iluminación LED en la cámara interior y display de control de mandos.

- Vitrine réfrigérée construite entièrement en verre et en acier inoxydable.
- Conçu pour conserver, présenter et exposer sur la barre / comptoir.
- Portes coulissantes pour l'accessibilité totale.
- Surface supérieure inclinée pour une vue panoramique.
- Système de refroidissement du compresseur. Fonction de dégivrage.
- Thermostat de commande de température réglable: 2-12°C.
- Sist. d'éclairage LED dans la chambre intérieure et le contrôle des commandes.

- Refrigerated showcase built entirely in glass and stainless steel.
- Designed to conserve, present and expose on the bar / counter.
- Sliding doors for total accessibility.
- Inclined upper surface for a panoramic view.
- Compressor cooling system. Defrost function.
- Adjustable temperature control thermostat: 2-12°C.
- Sist. of LED lighting in the inner chamber and control of controls.

CRISTAL INOX
Glass

Vitrina refrigerada

Vitrine réfrigérée · Kühlvitrine
Refrigerated display case · Vitrina refrigerada

| | Ref | € | W | Capacidad | Temperatura | Refrigerante | Medidas | U.Venta |
|--|-------|---------|-----|-----------|-------------|--------------|-------------|---------|
| | 69607 | 1113,60 | 105 | 40L | 2-12°C | R600a | 68x58x34 cm | 1 |



4
Cubetas
Containers



6
Cubetas
Containers

- Vitrina refrigerada construida íntegramente en cristal y acero inoxidable.
- Diseñada para conservar, presentar y exponer sobre la barra / mostrador.
- Puertas correderas para una accesibilidad total.
- Superficie superior curvada para una visión panorámica.
- Sistema de enfriamiento por compresor.
- Cubetas gastronorm 1/3 incluidas.
- Termostato de control de temperatura regulable: 0-12°C.
- Sistema de iluminación LED en la cámara interior y display de control de mandos.

- Vitrine réfrigérée construite entièrement en verre et en acier inoxydable.
- Conçu pour conserver, présenter et exposer sur la barre / comptoir.
- Portes coulissantes pour l'accessibilité totale.
- Surface supérieure incurvée pour une vue panoramique.
- Système de refroidissement du compresseur.
- Cubetas Gastronorm 1/3 inclus.
- Thermostat de commande de température réglable: 0-12°C.
- Système d'éclairage LED dans l'écran de commande de la chambre intérieure et de la commande.

- Refrigerated showcase built entirely in glass and stainless steel.
- Designed to conserve, present and expose on the bar / counter.
- Sliding doors for total accessibility.
- Curved upper surface for a panoramic view.
- Compressor cooling system.
- Gastronorm 1/3 trays included.
- Adjustable temperature control thermostat: 0-12°C.
- LED lighting system in the inner chamber and control control display.



Control de temperatura
regulable
Temperature control thermostat

Puertas traseras correderas
Sliding rear doors

INOX CRISTAL
Glass

Vitrina refrigerada GN

Vitrine réfrigérée · Kühlvitrine
Refrigerated display case · Vitrina refrigerada

| | Ref | € | W | Capacidad | Temperatura | Refrigerante | Medidas | U.Venta |
|---|-------|---------|-----|-----------|-------------|--------------|----------------|---------|
| A | 69605 | 1270,50 | 160 | 4x GN 1/3 | 0°C-12°C | R600a | 112,1x45x33 cm | 1 |
| B | 69606 | 1408,60 | 160 | 6x GN 1/3 | 0°C-12°C | R600a | 148,3x45x33 cm | 1 |

69602

Combinaciones posibles
Possible combinations

| | |
|--------|--------|
| GN 2/3 | GN 2/3 |
|--------|--------|

| | | | |
|--------|--------|--------|--------|
| GN 1/3 | GN 1/3 | GN 1/3 | GN 1/3 |
|--------|--------|--------|--------|

69603

Combinaciones posibles
Possible combinations

| | | |
|--------|--------|--------|
| GN 2/3 | GN 2/3 | GN 2/3 |
|--------|--------|--------|

| | | | |
|--------|--------|--------|--------|
| GN 1/2 | GN 1/2 | GN 1/2 | GN 1/2 |
|--------|--------|--------|--------|

| | | | | | |
|--------|--------|--------|--------|--------|--------|
| GN 1/3 | GN 1/3 | GN 1/3 | GN 1/3 | GN 1/3 | GN 1/3 |
|--------|--------|--------|--------|--------|--------|

04

Repostería
Pastry

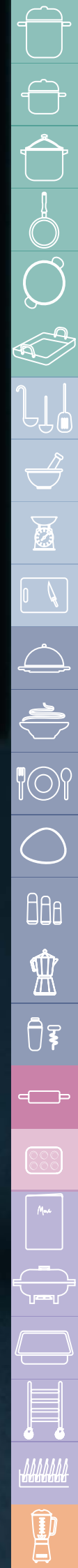

Jarras medidoras

INOX 18/10
Dishwasher



Jarra medidora Inox
Pot mesureur · Mass Behälter
Measuring jug · Jarra de medidas

| Ref | € | Ø (cm) | L | U.Venta |
|-------|--------------|---------|------|---------|
| 62750 | 77,90 | 17x22,5 | 5,00 | 1 |

Jarra medidora
Couvercle · Deckel
Lid · Tampa



| Ref | € | Ø (cm) | h(cm) | L | U.Venta |
|-------|--------------|--------|-------|-----|---------|
| 62741 | 22,40 | 11,5 | 13,0 | 1,0 | 1 |
| 62742 | 26,50 | 15,0 | 17,0 | 2,0 | 1 |

VIDRIO
Glass
Microwave



Jarra medidora Cristal
Pot mesureur · Mass Behälter
Measuring jug · Jarra de medidas

| Ref | € | L | U.Venta |
|-------|--------------|-----|---------|
| 67133 | 11,30 | 0,5 | 1 |

SAN
Plastic
BPA free



Set 3 jarras medidoras Tri
Ensemble de 3 pot mesureur · 3-tlg. Satz Messbecher
3 piece measuring jugs · Jogo 3 jarras de medidas

| Ref | € | L | U.Venta |
|-------|--------------|------|---------|
| 67131 | 15,60 | 0,25 | 1 |
| | | 0,5 | |
| | | 1,0 | |

PMMA
Plastic
BPA free



Vaso medidor Basic
Verre doseur · Messbecher
Measuring cup · Copo medidor

| Ref | € | Ø (cm) | h(cm) | L | U.Venta |
|-------|-------------|--------|-------|-----|---------|
| 67075 | 7,60 | 8,5 | 16,0 | 0,5 | 1 |
| 67071 | 9,90 | 10,5 | 19,0 | 1,0 | 1 |

PP
Polypropylene
BPA free



Set 3 jarras medidoras
Set 3 pichets doseurs · Messbecher, 3 Er-Set
Set of 3 measuring jugs · Conjunto 3 jarras medidas

| Ref | € | Ø (cm) | h(cm) | L | U.Venta |
|-------|-------------|--------|-------|------|---------|
| 67130 | 9,40 | 9,5 | 8,5 | 0,25 | 1 |
| | | 11,0 | 10,0 | 0,50 | |
| | | 13,0 | 11,5 | 1,00 | |

PP
Polypropylene
BPA free



Jarras medidoras Pro
Pot mesureur · Mass Behälter
Measuring jugs · Jarras de medidas

| Ref | € | Ø (cm) | h(cm) | L | U.Venta |
|-------|--------------|--------|-------|-----|---------|
| 67210 | 3,60 | 9,0 | 13,8 | 0,5 | 1 |
| 67211 | 4,70 | 12,0 | 17,0 | 1,0 | 1 |
| 67212 | 8,10 | 15,0 | 20,8 | 2,0 | 1 |
| 67213 | 10,60 | 17,0 | 23,5 | 3,0 | 1 |
| 67214 | 16,40 | 20,0 | 27,5 | 5,0 | 1 |

PP
Polypropylene
BPA free



Set 5 jarras medidoras Pro
Setn 5 pichets doseurs · Messbecher, 5 Er-Set
Set of 5 measuring jugs · Conjunto 5 jarras medidas

| Ref | € | cm | h(cm) | L | U.Venta |
|-------|--------------|-------|-------|-----|---------|
| 67215 | 41,00 | 15x9 | 15,3 | 0,5 | 1 |
| | | 18x11 | 18,8 | 1,0 | |
| | | 22x15 | 23,0 | 2,0 | |
| | | 24x17 | 26,0 | 3,0 | |
| | | 27x20 | 30,2 | 5,0 | |

Cazos y cucharas de medición

INOX 18/10
Dishwasher



Juego de cucharas medidoras
Ensemble de cuillères à doser · Messlöffel-Set
Measuring set · Jogo de colheres de medidas

| Ref | € | ml | U.Venta |
|---------|--------------|------------------|---------|
| A 67001 | 11,00 | 0,62/1,25/2/5/15 | 1 |
| B 67037 | 4,10 | 1,25/2,5/5/15 | 1 |

Muestra los resultados en gramos (g) y onzas (oz)
Shows the results in grams (g) and ounces (oz)



Cuchara medidora digital
Cuillère avec Balance Digitale · Digitale Löffelwaage
Digital spoon scale · Colher de pesar Digital

| Ref | € | Peso (g) | División (g) | Largo (cm) | U.Venta |
|-------|--------------|----------|--------------|------------|---------|
| 62519 | 40,60 | 300 | 0,10 | 28 | 1 |

INOX 18/10



Librador Inox
Pelle à farine · Mehlschaufel
Ice shovel · Corredor

| Ref | € | ml | Largo (cm) | Ancho (cm) | U.Venta |
|-------|--------------|-----|------------|------------|---------|
| 67012 | 17,90 | 60 | 19,0 | 5,0 | 6 |
| 67013 | 20,80 | 110 | 21,5 | 6,0 | 6 |
| 67014 | 24,60 | 200 | 24,0 | 7,0 | 6 |
| 67016 | 27,30 | 260 | 25,5 | 8,5 | 1 |
| 67017 | 30,30 | 360 | 29,0 | 10,0 | 6 |
| 67018 | 32,70 | 470 | 31,0 | 11,0 | 6 |
| 67019 | 40,70 | 640 | 35,0 | 12,5 | 6 |
| 67020 | 48,70 | 860 | 38,0 | 14,0 | 6 |

Graduadas y marcadas en ml y tsp
Marked and graduated in ml and cups



Juego de cazos medidores
Ensemble de dosettes à doser · Mass-Pfännchen-Set
Measuring cup · Jogo de caçaroles de medidas

| Ref | € | ml | U.Venta |
|---------|--------------|-------------------|---------|
| A 67007 | 11,90 | 60/80/125/250 | 4 |
| B 67036 | 6,30 | 60/80/120/180/235 | 1 |

- Cuchara báscula con pantalla digital y selección de medidas entre gramos u onzas.
- Ideal para pesar pequeñas cantidades: levadura, especias, suero, aceite, etc.
- Diseñado para recetas de poco gramaje y alta precisión.
- Apagado automático. Función congelación de pantalla. Función tara.
- Cuchara desmontable; se puede lavar en el lavavajillas.
- Medidas: Largo total con mango: 22 x 2,5 cm / Cuchara: 6 x 4,5 x 2 cm
- Pila incluida.
- Para una óptima medición se aconseja posicionar la cuchara sobre una superficie.

- Spoon scales with digital screen and selection of measures between grams or ounces.
- Ideal to weigh small amounts: yeast, spices, serum, oil, etc.
- Designed for little weight and high precision recipes.
- Auto power off. Screen freezing function. Tara function
- Detachable spoon; You can wash it in the dishwasher.
- Measures: Total length with handle: 22 x 2.5 cm / spoon: 6 x 4.5 x 2 cm
- Pila included.
- For optimal measurement it is advisable to position the spoon on a surface.

PC
Polycarbonate



Librador
Pelle à farine · Mehlschaufel
Ice shovel · Corredor

| Ref | € | ml | Mango (cm) | U.Venta |
|---------|--------------|------|------------|---------|
| A 67021 | 5,90 | 170 | 12 | 1 |
| B 67022 | 11,90 | 900 | 12 | 1 |
| C 67023 | 16,30 | 1800 | 14 | 1 |

Boles



- Set de 3 boles de acero inoxidable de máxima calidad.
- Acabado interior y exterior satinado.
- Versátiles: ideales para mezclar, batir, preparar masas y servir ensaladas o salsas.
- Perfectos para almacenar y conservar los alimentos.
- Compuesto por 3 boles perfectamente apilables entre sí.
- Base 100% antideslizante.
- Incluye 3 tapas herméticas fabricadas en polipropileno, libres de BPA.
- Marcaje de capacidad en el interior (L).
- Fácil limpieza.

- Ensemble de 3 bols en acier inoxydable de qualité maximale.
- Finition intérieure et extérieure satinée.
- Polyvyle: idéal pour mélanger, battre, préparer des masses et servir les salades ou les sauces.
- Parfait pour stocker et conserver la nourriture.
- Composé de 3 bols parfaitement empilables les uns avec les autres.
- Base 100% non glissante.
- Comprend 3 couvertures hermétiques en polypropylène, sans BPA.
- Marquage de capacité à l'intérieur (L).
- Nettoyage facile.

- Set of 3 maximum quality stainless steel bowls.
- Satinated interior and exterior finish.
- Versatile: Ideal to mix, beat, prepare masses and serve salads or sauces.
- Perfect to store and conserve food.
- Composed of 3 perfectly stackable bowls with each other.
- 100% non-slip base.
- Includes 3 hermetic covers made of polypropylene, BPA free.
- Capacity marking inside (L).
- Easy cleaning.



garinox®



Set 3 boles Inox

Ensemble de 3 récipients · Schüsseln, 3er-Set
Set of 3 bowls · Conjunto de 3 tigelas

| Ref | € | Ø (cm) | h(cm) | L | U.Venta |
|-------|-------|--------|-------|-----|---------|
| 60050 | 33,30 | 16 | 10,0 | 1,5 | 1 |
| | | 18 | 11,0 | 2,2 | |
| | | 20 | 12,5 | 3,0 | |
| 60051 | 44,90 | 20 | 12,5 | 3,0 | 1 |
| | | 22 | 13,5 | 3,8 | |
| | | 24 | 14,0 | 4,0 | |

Bol Cónico Garinox

Bol conique · Schüssel, konisch
Conical mixing bowl · Bacia cónica

| Ref | € | Ø (cm) | h(cm) | L | U.Venta |
|-------|-------|--------|-------|-------|---------|
| 14016 | 3,90 | 16 | 6,5 | 0,90 | 12 |
| 14019 | 5,30 | 20 | 7,5 | 1,40 | 12 |
| 14025 | 9,70 | 24 | 9,0 | 2,50 | 1 |
| 14029 | 13,20 | 30 | 11,0 | 4,30 | 1 |
| 14033 | 18,30 | 34 | 13,5 | 7,50 | 1 |
| 14040 | 23,30 | 40 | 15,5 | 11,50 | 1 |
| 14046 | 33,10 | 45 | 17,5 | 17,40 | 1 |
| 14049 | 38,80 | 50 | 19,0 | 22,60 | 1 |



Set 3 boles Multi

Ensemble de 6 récipients · Schüsseln, 6er-Set
Set of 6 bowls · Conjunto de 6 tigelas

| Ref | € | Ø (cm) | h(cm) | L | U.Venta |
|-------|-------|--------|-------|------|---------|
| 60055 | 20,50 | 10,0 | 5,0 | 0,25 | 1 |
| | | 14,0 | 6,8 | 0,80 | |
| | | 17,0 | 8,0 | 1,15 | |
| | | 20,3 | 9,5 | 2,00 | |
| | | 24,3 | 11,0 | 3,35 | |
| | | 28,3 | 12,5 | 5,25 | |

Jarra medidora · Measuring jug (0,5 L)



Jarra medidora · Measuring jug (1,0 L)



Escurreidor · Colander (2,0 L)



Bol mezclador · Mixing bowl (3,5 L)



Set de 4 boles Practic

Ensemble de 4 récipients · Schüsseln, 4er-Set
Set of 4 bowls · Conjunto de 4 tigelas

| Ref | € | Ø (cm) | h(cm) | L | U.Venta |
|-------|-------|--------|-------|-----|---------|
| 62633 | 36,10 | 11,5 | 9,3 | 0,5 | 1 |
| | | 14,5 | 10,6 | 1,0 | |
| | | 18,5 | 13,0 | 2,0 | |
| | | 22,0 | 15,0 | 3,5 | |



Raspador · Scraper

6 cazos medidores
6 measuring cups
(7,5 ml, 15 ml, 60 ml,
85 ml, 125 ml, 250 ml)

Embudo · Funnel

Jarra medidora
Measuring jug
(1,0 L / 4 cups)



Set de medición Exact

Set de mesure · Messbecher-Set
Measuring set · Conjunto de medição

| Ref | € | cm | h(cm) | U.Venta |
|-------|-------|-------|-------|---------|
| 62740 | 16,40 | 20x11 | 13,6 | 1 |



- Set de 6 boles de polipropileno de máxima calidad, 100% libres de BPA.
- Versátiles: ideales para mezclar, batir, preparar masas, servir ensaladas o salsas.
- Compuesto por 6 boles perfectamente apilables entre sí.
- Incluye 6 tapas fabricadas en polipropileno, libres de BPA.
- Perfectos para almacenar y conservar los alimentos.
- Fácil limpieza. Cuerpos aptos para el lavavajillas.

- Set of 6 polypropylene bowls of maximum quality, 100% free of BPA.
- Versatile: Ideal to mix, beat, prepare masses, serve salads or sauces.
- Composed of 6 bolts perfectly stackable to each other.
- Includes 6 covers manufactured in polypropylene, BPA free.
- Perfect to store and conserve food.
- Easy cleaning. Bodies suitable for dishwasher.

- Práctico y versátil.
- Fabricados en polipropileno de máxima calidad. 100% Libre de BPA.
- Jarras medidoras graduadas (mililitros/cups).
- Pequeño vertedor lateral para facilitar el vertido.
- Asas ergonómicas para facilitar el transporte.
- 100% estable gracias a los pies antideslizantes.
- Apilables; ocupan el mínimo espacio posible.
- Aptos para el lavavajillas.

- Practical and versatile.
- Manufactured in maximum quality polypropylene. 100% BPA free.
- Graduated meter jugs (milliliters/cups).
- Small lateral dump to facilitate discharge.
- Ergonomic handles to facilitate transportation.
- 100% stable thanks to non-slip feet.
- Stackable; They occupy the minimum possible space.
- Apt for the dishwasher.

- Todas las piezas fabricadas en materiales de máxima calidad, libres de BPA.
- Versátil. Ideal para ingredientes líquidos y secos.
- Jarra con sistema de lectura rápida en litros y cups. Permite comprobar el nivel del líquido mientras se está vertiendo el contenido.
- Cazos marcados en ml y bps para una rápida identificación.

- All pieces made of maximum quality materials, BPA free.
- Versatile. Ideal for liquid and dry ingredients.
- Jug with fast reading system in liters and cups. It allows to check the level of the liquid while the content is pouring.
- Saves marked in ML and BPS for rapid identification.

Calderos

INOX 18/10
Dishwasher

- Ideal para mezclar los alimentos.
- Para uso profesional o doméstico.
- Fabricado en acero inoxidable 18/10, material muy resistente a la corrosión y ácidos alimentarios.
- Fácil limpieza: apto para el lavavajillas.

- Idéal pour mélanger les aliments.
- Pour un usage professionnel ou domestique.
- Fabriqué en acier inoxydable 18/10, très résistant à la corrosion et aux acides alimentaires.
- Nettoyage facile: adapté au lave-vaisselle.

- Ideal for mixing food.
- For professional or domestic use.
- Manufactured in stainless steel 18/10, very resistant to corrosion and food acids.
- Easy cleaning: suitable for dishwasher.



Caldero semiesférico sin asas

Bassine hemispherique s/anses · Schneeschlagkessel ohne Griffe
Semi-spherical mixing bowl wout/handles · Bacia semi-esférica sem asas

| Ref | € | Ø (cm) | h(cm) | L | U.Venta |
|--------|--------|--------|-------|-------|---------|
| 50323S | 37,50 | 22 | 11,0 | 2,70 | 1 |
| 50327S | 43,80 | 26 | 13,0 | 4,00 | 1 |
| 50333S | 58,80 | 32 | 17,0 | 9,50 | 1 |
| 50337S | 66,70 | 36 | 18,0 | 12,00 | 1 |
| 50341S | 111,90 | 40 | 21,0 | 14,50 | 1 |
| 50300 | 26,40 | - | - | - | 1 |

Caldero semiesférico con asas

Bassine hemispherique a/anses · Schneeschlagkessel mit Griffe
Semi-spherical mixing bowl w/handles · Bacia semi-esférica com asas

| Ref | € | Ø (cm) | h(cm) | L | U.Venta |
|-------|--------|--------|-------|-------|---------|
| 50323 | 49,40 | 22 | 11,0 | 2,70 | 1 |
| 50327 | 56,20 | 26 | 13,0 | 4,00 | 1 |
| 50333 | 72,20 | 32 | 17,0 | 9,50 | 1 |
| 50337 | 77,70 | 36 | 18,0 | 12,00 | 1 |
| 50341 | 111,10 | 40 | 21,0 | 14,50 | 1 |
| 50300 | 26,40 | - | - | - | 1 |



Caldero cónico

Bassine conique · Wanne
Mixing bowl · Bacia cónica

| Ref | € | Ø (cm) | h(cm) | L | U.Venta |
|-------|-------|--------|-------|-------|---------|
| 60013 | 12,70 | 13 | 6,1 | 0,55 | 1 |
| 60016 | 13,80 | 16 | 9,1 | 1,00 | 1 |
| 60020 | 18,90 | 20 | 11,7 | 2,12 | 1 |
| 60024 | 22,70 | 24 | 12,6 | 3,50 | 1 |
| 60028 | 28,40 | 28 | 13,4 | 5,25 | 1 |
| 60032 | 31,90 | 32 | 15,0 | 7,65 | 1 |
| 60036 | 44,10 | 36 | 16,0 | 11,00 | 1 |
| 60040 | 51,20 | 40 | 18,0 | 15,00 | 1 |

Caldero cónico con asas

Bassine conique à anses · Wanne mit Griffe
Conical mixing bowl · Bacia cónica con asas

| Ref | € | Ø (cm) | h(cm) | L | U.Venta |
|-------|-------|--------|-------|-------|---------|
| 50828 | 44,30 | 28 | 13,2 | 5,00 | 1 |
| 50832 | 49,10 | 32 | 14,5 | 7,00 | 1 |
| 50836 | 56,20 | 36 | 16,0 | 11,00 | 1 |
| 50840 | 62,50 | 40 | 18,0 | 15,00 | 1 |
| 50845 | 74,60 | 45 | 20,0 | 22,00 | 1 |
| 50850 | 89,50 | 50 | 21,0 | 30,00 | 1 |

Cedazos

INOX 18/10
Dishwasher



Orificios/pulgada · eyes/inch = 50
Cuadrado · Square: 0,35x0,35 mm



Orificios/pulgada · eyes/inch = 35
Cuadrado · Square: 0,50x0,50 mm

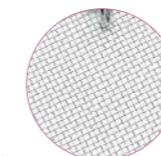

Orificios/pulgada · eyes/inch = 25
Cuadrado · Square: 0,75x0,75 mm

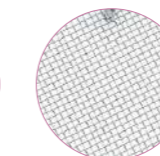

Orificios/pulgada · eyes/inch = 20
Cuadrado · Square: 1x1 mm

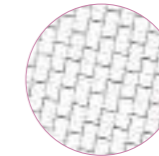

9 orificios/pulgada · 8 eyes/inch
Cuadrado · Square: 2x2 mm
Ø Varilla · Rod: 0,40 mm



20 orificios/pulgada · 20 eyes/inch
Cuadrado · Square: 1x1 mm
Ø Varilla · Rod: 0,27 mm

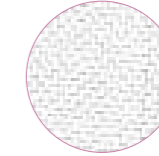

12 orificios/pulgada · 12 eyes/inch
Cuadrado · Square: 1,35x1,35 mm
Ø Varilla · Rod: 0,35 mm

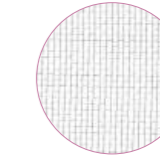

40 orificios/pulgada · 40 eyes/inch
Cuadrado · Square: 0,7x0,7 mm
Ø Varilla · Rod: 0,12 mm

Cedazo

Tamis · Mehlsieb
Sieve · Peneira

| Ref | € | Ø (cm) |
|-------|--------|--------|
| 68058 | 39,50 | 18 |
| 68050 | 43,20 | 20 |
| 68057 | 60,00 | 26 |
| 68053 | 72,30 | 30 |
| 68054 | 98,70 | 40 |
| 68350 | 39,80 | 20 |
| 68357 | 59,90 | 26 |
| 68351 | 67,80 | 30 |
| 68354 | 101,40 | 40 |
| 68250 | 39,50 | 20 |
| 68252 | 59,50 | 26 |
| 68253 | 66,20 | 30 |
| 68254 | 102,40 | 40 |
| 68026 | 62,30 | 26 |
| 68023 | 69,30 | 30 |
| 68024 | 104,60 | 40 |

50 Hilos por pulgada
Wires-inch

35 Hilos por pulgada
Wires-inch

25 Hilos por pulgada
Wires-inch

20 Hilos por pulgada
Wires-inch



Cedazo 4 mallas intercambiable

Tamis à 4 mailles interchangeables · 4 Austauschbare Masche-Sieb
Mesh sieve interchangeable · Peneira de 4 malha intercambiáveis

| Ref | € | Ø (cm) | U.Venta |
|-------|-------|--------|---------|
| 68340 | 33,90 | 20 | 1 |
| 68341 | 40,90 | 23 | 1 |
| 68342 | 50,70 | 25 | 1 |

Ideal para harina, chocolate en polvo, levaduras, etc. Mecanismo en el asa en forma de gatillo
Ideal for flour, chocolate powder, yeasts, etc. Trigger handle mechanism



INOX

Cribador de harina Inox

Tamis · Mehlsieb
Flour sifter · Crivador de farinha

| Ref | € | Ø (cm) | Peso (Kg) | U.Venta |
|-------|-------|--------|-----------|---------|
| 67011 | 10,90 | 10,0 | 0,35 | 5 |
| 67015 | 14,50 | 12,0 | 0,50 | 1 |



AS
Plastic



Cribador de harina

Tamis · Mehlsieb
Flour sifter · Crivador de farinha

| Ref | € | Ø (cm) | Peso (Kg) | U.Venta |
|-------|------|--------|-----------|---------|
| 67025 | 7,40 | 10 | 0,35 | 6 |

Rasquetas

INOX

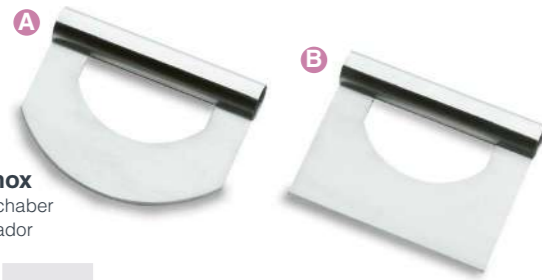

INOX 18/10

Rasqueta Inox Black
Coupe pate · Schaber
Scraper · Raspador

| Ref | € | cm | U.Venta |
|-------|------|-----------|---------|
| 67029 | 9,70 | 16,5x10,5 | 6 |

Rasqueta Inox
Coupe pate · Schaber
Scraper · Raspador

| Ref | € | cm | U.Venta |
|-------|-------|------|---------|
| 67005 | 13,20 | 15x9 | 6 |
| 67006 | 12,70 | 15x9 | 6 |



Rasqueta
Coupe pate · Schaber
Scraper · Raspador

| Ref | € | cm | U.Venta |
|-------|-------|---------|---------|
| 67041 | 25,80 | 13,8x13 | 1 |

SI

230°C Max



Rasqueta Flex
Coupe pate · Schaber
Scraper · Raspador

| Ref | € | cm | U.Venta |
|-------|------|------|---------|
| 67414 | 9,10 | 9x15 | 1 |

Decoración

PP



Rasqueta decoración
Grattoir à pate · Teigschaber
Dough scrape · Raspador de masa

| Ref | € | mm | U.Venta |
|-------|------|---------|---------|
| 68132 | 1,80 | 155x105 | 24 |

Peine decoración
Peigne du decoration · Verzierungskamm
Decorating comb · Pente de decoração

| Ref | € | mm | U.Venta |
|-------|------|-----|---------|
| 68136 | 1,50 | 110 | 24 |

Juego peines decoración
Set peigne du decoration · Verzierungskamm-Set
Decorating comb set · Jogo pente de decoração

| Ref | € | Piezas | U.Venta |
|-------|------|--------|---------|
| 68137 | 6,00 | 7 | 1 |

ABS
Plastic



Estacas decoración Fondant
Outils de modelisation · Modellierset
Modeling tools · Ferramentas demodelagen

| Ref | € | Piezas | U.Venta |
|-------|-------|--------|---------|
| 68090 | 11,50 | 12 | 1 |

Pinceles

SI

INOX 18/10

230°C Max



- Para cocina o repostería.
- Pinceles ideales para pincelar con aceites o salsas, marinar carnes o pescados, engrasar moldes, untar con aceite, huevo batido, almíbar, etc.
- No absorben olores ni sabores.

- Pour la cuisine ou la pâtisserie.
- Pinceaus parfaits pour badigeonner de l'huile ou des sauces, mariner des viandes ou des poissons, graisser des moules, étaler de l'huile, de l'œuf battu, du sirop, etc.
- N'absorbent ni les odeurs ni les goûts.

- For cooking or baking.
- Brushes ideal for brushing oils or sauces, marinating meat or fish, greasing baking tins, and basting with oil, egg, syrup, etc.
- Doesn't absorb smells or tastes.

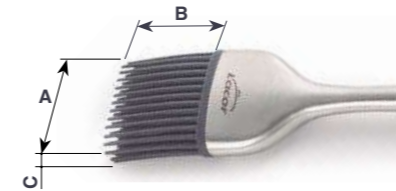

PP
Polypropylene

Pincel Virola
Pinceau · Silikonpinsel
Brush · Pincel

| Ref | € | A (cm) | B (cm) | Largo (cm) | U.Venta |
|-------|------|--------|--------|------------|---------|
| 64430 | 4,40 | 2,8 | 5,0 | 23,0 | 1 |
| 64435 | 5,10 | 3,2 | 5,5 | 24,0 | 1 |
| 64440 | 5,30 | 3,8 | 5,5 | 24,5 | 1 |
| 65044 | 6,60 | 4,2 | 6,5 | 25,0 | 1 |
| 65050 | 7,90 | 4,7 | 6,5 | 26,0 | 1 |

Dimensiones reales · Real dimensions

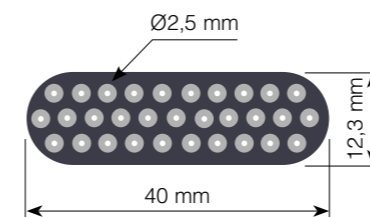

SI

INOX

Pincel de silicona Mix
Pinceau de cuisine en silicone · Silikonpinsel
Silicone brush · Pincel de silicone

| Ref | € | A (cm) | B (cm) | Largo (cm) | U.Venta |
|-------|------|--------|--------|------------|---------|
| 64431 | 7,40 | 3,8 | 4,0 | 24 | 12 |

Pincel de silicona Pro
Pinceau en silicone · Silikonpinsel
Silicon brush · Pincel silicone

| Ref | € | A (cm) | B (cm) | Largo (cm) | U.Venta |
|-------|-------|--------|--------|------------|---------|
| 64418 | 11,10 | 4,0 | 4,0 | 22 | 1 |
| 64422 | 12,40 | 4,0 | 4,0 | 23 | 1 |



Pincel de silicona
Pinceau en silicone · Silikonpinsel
Silicon brush · Pincel de silicone

| Ref | € | A (cm) | B (cm) | Largo (cm) | U.Venta |
|-------|------|--------|--------|------------|---------|
| 64441 | 6,90 | 5,8 | 3,4 | 23 | 1 |



HAYA 230°C Max



Pincel de silicona Unite
Pinceau · Silikonpinsel
Brush · Pincel

| Ref | € | A (cm) | B (cm) | Largo (cm) | U.Venta |
|-------|------|--------|--------|------------|---------|
| 68196 | 4,20 | 5,5 | 3,1 | 24,5 | 1 |



Espátula para atemperar

INOX
Dishwasher



- Espátula profesional de acero inoxidable de máxima calidad, de grado alimenticio, resistente y duradero.
- Diseñado para templar chocolate recién fundido, glasear pasteles, cortar masas de galletas, pizzas, etc.
- Hoja superafilada trapezoidal semiflexible de 16/22 cm de ancho.
- Mango ergonómico y resistente con orificio colgante.

- Spatule professionnelle en acier inoxydable de la plus grande qualité, à usage alimentaire, résistante et durable.
- Conçue pour le tempérage du chocolat fraîchement fondu, le glaçage des gâteaux, couper des pâtes à biscuits, pour les pizzas, etc.
- Feuille très aiguisée semi-flexible de 16/22 cm de largeur.
- Manche ergonomique et résistant, avec œillet de suspension.

- Professional spatula made of high quality, food-grade stainless steel, strong and durable.
- Designed for tempering freshly melted chocolate, glazing cakes, cutting dough for biscuits, pizzas, etc.
- Super-sharp, semi-flexible 16/22 cm wide trapezoidal blade.
- Sturdy, ergonomic handle with hanging hole.

Espátula para atemperar chocolate

Spatule pour tempérer le chocolat · Spatel zum Temperieren von Schokolade
Chocolate tempering spatula · Espátula para atemperar chocolate

| | Ref | € | Largo (cm) | U.Venta |
|---|-------|------|------------|---------|
| A | 60533 | 7,00 | 16 | 1 |
| B | 60534 | 7,60 | 22 | 1 |

Espátulas de silicona

SI FE LFGB 230°C Max
Silicone Iron Food Grade Silicone Dishwasher BPA free

- Fabricados en silicona de alta calidad libre de BPA.
- Núcleo reforzado para una mayor resistencia sin perder flexibilidad en los bordes. Diseñados en una sola pieza, sin costuras ni grietas.
- Resistentes a altas temperaturas.
- Mango ergonómico suave al tacto y antideslizante.
- No rayan ni dañan artículos de cocina con antiadherente.
- Fáciles de limpiar. Aptas para el lavavajillas.

- Fabriqué en silicone de haute qualité sans BPA.
- Noyau renforcé pour une résistance accrue sans perte de flexibilité des bords. Conception monobloc, sans coutures ni fissures.
- Résistant aux hautes températures.
- Poignée ergonomique, douce au toucher et antidérapante.
- Ne raye pas et n'endommage pas les ustensiles de cuisine antiadhésifs.
- Facile à nettoyer. Lavable au lave-vaisselle.

- Made of high quality BPA free silicone.
- Reinforced core improves strength without losing flexibility around the edges. Designed in a single piece without seams or cracks.
- Can withstand high temperatures.
- Soft and non-slip ergonomic handle.
- Does not scratch cooking utensils with non-stick coating.
- Easy to clean. Dishwasher safe.

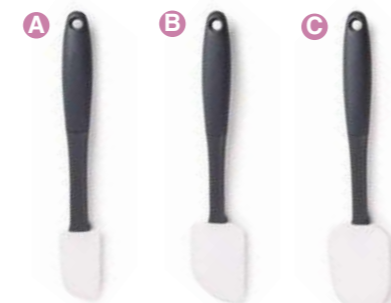

Utensilios Grey

Utensiles en silicone · Silikonutensilien
Silicone utensils · Utensílios de silicone

| | Ref | € | Largo (cm) | U.Venta |
|---|-------|------|------------|---------|
| A | 64463 | 5,60 | 27,5 | 1 |
| B | 64464 | 5,60 | 27,5 | 1 |
| C | 64465 | 5,70 | 27,5 | 1 |

Utensilios Ocean

Utensiles en silicone · Silikonutensilien
Silicone utensils · Utensílios de silicone

| | Ref | € | Largo (cm) | U.Venta |
|-----|-------|-------|------------|---------|
| Set | 64452 | 17,20 | 27,5 | 1 |
| A | 64453 | 6,00 | 27,5 | 1 |
| B | 64454 | 6,00 | 27,5 | 1 |
| C | 64455 | 6,00 | 27,5 | 1 |

Espátula Comfort

Spatule en silicone · Teigschaber
Silicone spatula · Espátula de silicone

| | Ref | € | Largo (cm) | U.Venta |
|---|-------|------|------------|---------|
| A | 64444 | 6,10 | 28 | 1 |
| B | 64445 | 6,80 | 30 | 1 |
| C | 64446 | 6,90 | 31 | 1 |

Espátula White

Spatule en silicone · Teigschaber
Silicone spatula · Espátula de silicone

| | Ref | € | Largo (cm) | U.Venta |
|--|-------|-------|------------|---------|
| | 67421 | 4,70 | 20 | 1 |
| | 67427 | 7,00 | 26 | 1 |
| | 67433 | 15,30 | 32 | 1 |

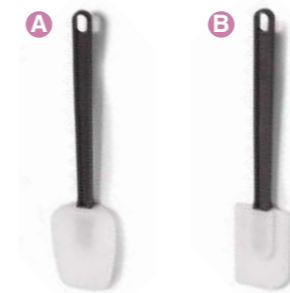

Espátula Grey

Spatule en silicone · Teigschaber
Silicone spatula · Espátula de silicone

| | Ref | € | Largo (cm) | U.Venta |
|--|-------|------|------------|---------|
| | 67434 | 4,80 | 30 | 12 |
| | 67435 | 5,60 | 29 | 12 |



Espátula silicona

Spatule en silicone · Teigschaber
Silicone spatula · Espátula de silicone

| | Ref | € | Largo (cm) | U.Venta |
|---|-------|-------|------------|---------|
| A | 64450 | 5,70 | 25 | 6 |
| | 64451 | 9,10 | 35 | 6 |
| B | 64460 | 6,00 | 25 | 6 |
| | 64461 | 10,00 | 35 | 6 |

Espátula para tarros

Spatule en silicone · Teigschaber
Silicone spatula · Espátula de silicone

| | Ref | € | cm | Largo (cm) | U.Venta |
|--|-------|------|----------|------------|---------|
| | 64490 | 2,50 | 3,8x8,4 | 25 | 1 |
| | 64491 | 4,10 | 4,8x10,8 | 35 | 1 |



- Espátula extraplana fabricada en nylon y fibra de vidrio especialmente diseñada para uso profesional.
- Sólida e indeformable. Resistente a altas temperaturas.
- No absorbe olores ni sabores.
- Apta para el lavavajillas.

- Spatule extra plate fabriquée en nylon et fibre de verre spécialement conçue pour un usage professionnel.
- Résistante aux hautes températures.
- Solide et indéformable. N'absorbe ni les odeurs ni les goûts.
- Apte pour le lave-vaisselle.

- Super thin, glass fibre nylon spatula, specially designed for professional use.
- High temperature resistant.
- Robust and non-deformable.
- Does not absorb smells or flavours.
- Dishwasher safe.

Set repostería- 20 pcs.

Exposant pâtisserie · Aufsteller Pastry
Pastry display · Expositor pastelería

| | Ref | € | Largo (cm) | Piezas | U.Venta |
|---|-------|-------|------------|--------------------------------|---------|
| A | 64424 | 80,40 | - | Caja (20 pcs.) · Set (20 pcs.) | 1 |
| B | 64426 | 4,10 | 23,0 | Pincel · Brush | 12 |
| C | 64427 | 4,10 | 23,0 | Espátula · Spatula | 12 |
| D | 64428 | 4,10 | 23,0 | Lengua gato · Spatula | 12 |
| E | 64429 | 4,10 | 23,0 | Batidor · Whisk | 12 |





Batidores

INOX 18/10
Dishwasher

INOX

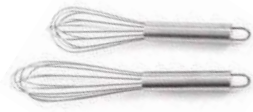

Batidor mini

Mini fouet inox · Mini-Schneebeesen
Mini whisk · Mini batedor Inóx

| Ref | € | Largo (cm) | U.Venta |
|-------|------|------------|---------|
| 61615 | 5,60 | 15 | 12 |
| 61620 | 6,20 | 20 | 12 |



SI 250°C Max
Silicone BPA free

Batidor varilla silicona

Fouet en silicone · Ruhrbesen auf Silikon
Silicone wire whisk · Batedor vareta silicone

| Ref | € | Largo (cm) | U.Venta |
|-------|-------|------------|---------|
| 61621 | 8,20 | 20 | 12 |
| 61622 | 9,10 | 25 | 6 |
| 61623 | 10,20 | 30 | 12 |

Batidor Extra 8

Fouet inox extra 8 · Schneebeesen, Extra 8
Extra 8 whisk · Batedor Extra 8

| Ref | € | Largo (cm) | U.Venta |
|-------|-------|------------|---------|
| 61625 | 8,70 | 25 | 6 |
| 61630 | 8,90 | 30 | 6 |
| 61635 | 9,30 | 35 | 6 |
| 61640 | 10,30 | 40 | 6 |
| 61645 | 11,10 | 45 | 6 |
| 61650 | 12,40 | 50 | 6 |
| 61655 | 13,20 | 55 | 6 |
| 61660 | 14,20 | 60 | 6 |

Batidor Super 12

Fouet inox super 12 · Schneebeesen, super 12
Super 12 whisk · Batedor Super 12

| Ref | € | Largo (cm) | U.Venta |
|-------|-------|------------|---------|
| 61626 | 8,00 | 25 | 6 |
| 61631 | 8,60 | 30 | 6 |
| 61636 | 9,30 | 35 | 6 |
| 61641 | 9,90 | 40 | 6 |
| 61646 | 10,20 | 45 | 6 |
| 61651 | 11,10 | 50 | 6 |



Batidor gigante

Fouet à purée · Kesselbesen
Big whisk · Batedor gigante

| Ref | € | cm | Diámetro varilla (mm) | U.Venta |
|-------|-------|-----|-----------------------|---------|
| 60610 | 64,10 | 100 | 3 | 12 |
| 60612 | 82,20 | 129 | 3 | 12 |



INOX 18/10 SI Silicone HAYA Wood LFGB Food Grade Silicone Dishwasher BPA free

Batidor varilla con espátula

Fouet avec grattoir · Schneebeesen mit Schaber
Whisk with spatula · Batedeira de varas com espátula

| Ref | € | Largo (cm) | U.Venta |
|-------|------|------------|---------|
| 68199 | 6,10 | 27,0 | 1 |
| 61627 | 6,40 | 32,0 | 12 |



Especial para preparar comidas que no contengan alérgenos.
Specially for preparing meals that do not contain allergens.

SI 250°C Max
Silicone BPA free

Batidor Fibreglass

Fouet · Schneebeesen
Whisk · Batedores

| Ref | € | Largo (cm) | U.Venta |
|-------|-------|------------|---------|
| 61624 | 12,10 | 25 | 6 |
| 61629 | 14,00 | 30 | 6 |
| 61634 | 15,80 | 35 | 6 |
| 61639 | 17,50 | 40 | 6 |
| 61644 | 21,00 | 45 | 6 |
| 61649 | 22,00 | 50 | 6 |

INOX

Batidor Manivela

Batteur-mélangeur à manivelle · Schneequiril
Egg beater · Batedor de manivela

| Ref | € | U.Venta |
|-------|-------|---------|
| 62901 | 19,60 | 6 |



- Batidor de varilla con práctico raspador de silicona incorporado.
- 2 en 1 : bate y recoge toda la mezcla del bol de forma fácil y rápida.
- Varillas fabricadas en acero inoxidable.
- Espátula de silicona inyectada en una de las varillas (certificado LFGB y libre de BPA).
- Mixeur en bâton avec raclette en silicone intégrée très pratique.
- 2 en 1 : fouette et recueille tous les mélanges dans le bol rapidement et facilement.
- Lames en acier inoxydable.
- Spatule en silicone injectée dans l'une des lames (certifiée LFGB et sans BPA).
- Blade mixer with practical built-in silicone scraper.
- 2 in 1 : Beat and scrape out the entire mixture from the bowl quickly and easily.
- Rods made of stainless steel.
- Silicone spatula injected into one of the blades (LFGB certified and BPA free).

Batidor · Whisk

Espátula · Spatula



Batidor antialérgico Fibreglass

Fouet · Schneebeesen
Whisk · Batedores

| Ref | € | Largo (cm) | U.Venta |
|-------|-------|------------|---------|
| 61590 | 11,10 | 25 | 6 |
| 61591 | 12,00 | 30 | 6 |
| 61592 | 14,00 | 35 | 6 |

Batidor silicona Fibreglass

Fouet en silicone · Schneebeesen, Silikon
Silicone whisk · Batedores silicone

| Ref | € | Largo (cm) | U.Venta |
|-------|-------|------------|---------|
| 61524 | 11,10 | 25 | 6 |
| 61529 | 12,00 | 30 | 6 |
| 61534 | 14,00 | 35 | 6 |



Batidor Capuccino

Batteur pour cappuccino · Capuccino- Mixer
Capuccino mixer · Batedor capuccino

| Ref | € | W | U.Venta |
|-------|-------|-----|---------|
| 69041 | 27,40 | 2,7 | 1 |

Rodillos

INOX
18/10



- Ideal para extender pequeñas cantidades de masa.
- Acabado uniforme para trabajar pastas, mazapán, fondant, etc.

- Idéal pour étaler de petites quantités de pâte.
- Finition uniforme pour travailler des pâtes, du massepain, des fondants, etc.

- Perfect for spreading small quantities of dough.
- Uniform nish when working with pastries, marzipan, fondant, etc.

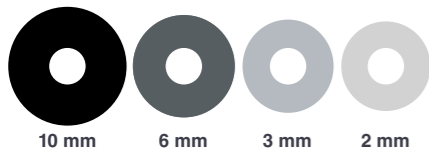
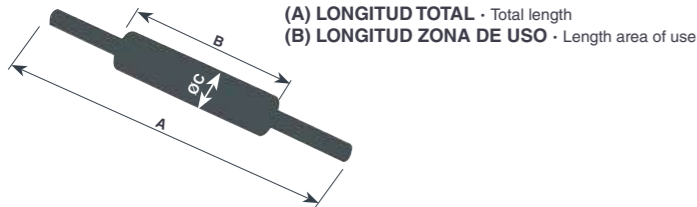

4 discos extraíbles · 4 removable discs



Anillas de polipropileno
Polypropylene rings

Guía para medir el ancho de la masa
Guide to measure the width of the dough



Rodillo amasar con anillas

Rouleau hêtre avec anneau · Teigroller mit Ringen
Rolling pin with guide rings · Rolo com anilhas

| Ref | € | Anillas | Largo (cm) | U.Venta |
|---------|-------|----------|------------|---------|
| A 67142 | 15,70 | 10/6/2 | 38 | 1 |
| B 67143 | 16,30 | 10/6/3/2 | 38 | 1 |



Rodillo cortador croissant

Rouleau pour coupe croissant · Schneidewalze für Croissantteig
Croissant dough cutter wheel · Rolo cortador de croissants

| Ref | € | Ancho (cm) | B (cm) | Ø (cm) | U.Venta |
|-------|-------|------------|--------|--------|---------|
| 68161 | 34,30 | 40,5 | 15,3 | 7,7 | 1 |

Rodillo

Rouleau patisier · Teigroller
Rolling pin · Rolo

| Ref | € | A (cm) | ØCx B (cm) | U.Venta |
|---------|-------|--------|------------|---------|
| 67140 | 43,10 | 40 | Ø5x20 | 3 |
| A 67148 | 48,10 | 48 | Ø6,3x25 | 4 |
| 67156 | 51,40 | 56 | Ø6,3x33 | 4 |
| B 67149 | 49,90 | 48 | Ø6,3x25 | 4 |
| 68153 | 11,30 | 50 | 30 | 1 |
| 68154 | 21,40 | 60 | 40 | 1 |
| D 68142 | 10,00 | 43 | Ø4,4 | 1 |
| 68150 | 10,50 | 50 | Ø4,8 | 1 |
| 68141 | 36,60 | 43 | Ø4,4 | 1 |
| E 68151 | 44,70 | 90 | Ø4,8 | 1 |

Rodillo picar pasta

Rouleau pique vite pointe metal · Teig-Gitterschneider
Roller docker metal · Rolo de picar massas

| Ref | € | Largo (cm) | U.Venta |
|-------|-------|------------|---------|
| 68213 | 37,40 | 13 | 6 |



Rodillo Roller

Rouleau patisier · Teigroller
Rolling pin · Rolo

| Ref | € | cm | Largo (cm) | U.Venta |
|---------|------|----|------------|---------|
| A 68801 | 6,30 | 14 | 19,5 | 1 |
| B 68802 | 6,30 | 14 | 19,5 | 1 |
| C 68803 | 6,30 | 14 | 19,5 | 1 |
| D 68804 | 6,30 | 12 | 19,5 | 1 |



- Cortapastas extensible con 5 ruedas rizadas. Diámetro de la rueda 5,5 cm.
- Fabricada en acero inoxidable de gran calidad.
- Ideal para cortar todo tipo de masas, hojaldres, fondant, etc.
- Cortes precisos y tiras del mismo tamaño, ajustando el ancho de corte mediante un mecanismo de extensión.
- Las ruedas se bloquean en la posición deseada apretando la tuerca de mariposa.

- Roulette découpe-pâte extensible avec 5 roues cannelées. Diamètre des roues : 5,5 cm.
- Fabriqué en acier inoxydable de haute qualité.
- Idéal pour couper tous les types de pâte, pâte feuilletée, brisée, etc.
- Coupes précises et bandes de même taille, en réglant la largeur de coupe au moyen d'un mécanisme d'extension.
- Les roues sont bloquées dans la position souhaitée en serrant les écrous à ailettes.

- Extendable cutter with 5 crimped wheels. Wheel diameter: 5.5 cm.
- Made of high quality stainless steel.
- Ideal for cutting all types of dough, puff pastry, fondant, etc.
- Gives precise cuts and strips of the same size by adjusting the extending mechanism to set the desired cutting width.
- The wheels lock into the desired position by tightening the wing nuts.

Cerrado · Closed: 5,5x24 cm
Abierto · Open: 49,5x24 cm
Cuchillas · Blades: Ø5,5 cm



Cortapastas extensible

Rouleau multicouper · Teigschneider
Dough divider expandable · Corta-massas extensível

| Ref | € | Largo (cm) | U.Venta |
|-------|-------|------------|---------|
| 68246 | 20,00 | 24 | 1 |

- 68801: Corta con rapidez y precisión tiras de masa lisas y uniformes. Gracias a sus 9 ruedas extraíbles, podrás ajustar la anchura deseada.
- 68802: Diseñado para perforar cualquier tipo de masa (pasteles, quiches, hojaldres, pizza, etc.) Evita la formación de burbujas en las bases de masa durante el horneado.
- 68803: Corta con rapidez y precisión tiras de masa onduladas y uniformes. Gracias a sus 9 ruedas extraíbles, podrás ajustar la anchura deseada.
- 68804: Diseñado para formar una rejilla uniforme de pasta. Efecto simétrico enrejado, ideal para empanadas, pasteles de manzana, hojaldres, etc.
- Mango ergonómico
- Diseñado para todo tipo de masas. Deja volar tu imaginación.
- Fácil limpieza, 100% desmontable y apto para el lavavajillas.
- Material: ABS y mango de polipropileno. Libre de BPA.

- 68801 : Coupez avec rapidité et précision des bandes de pâte lisses et uniformes. Grâce à ses 9 roulettes amovibles, vous pourrez régler la largeur souhaitée.
- 68802 : Conçu pour piquer tout type de pâte (tartes, quiches, feuilletés, pizza, etc.). Évite la formation de bulles sur la base des pâtes pendant la cuisson.
- 68803 : Coupez avec rapidité et précision des bandes de pâtes ondulées et uniformes. Grâce à ses 9 roulettes amovibles, vous pourrez régler la largeur souhaitée.
- 68804 : Conçu pour faire un dessus de treillis de pâte uniforme. Effet symétrique de losanges, idéal pour des empanadas, des tartes aux pommes, des feuilletés, etc. Conçu pour tout type de pâtes. Laissez libre cours à votre imagination.
- Manche ergonomique.
- Nettoyage facile, 100% démontable et apte pour le lave-vaisselle.
- Matériau : ABS et manche en polypropylène. Sans BPA.

- 68801 : Quickly and accurately cuts smooth, even strips of dough. 9 removable cutting wheels allow you to adjust the desired width.
- 68802 : Designed for poking holes (also referred to as 'docking') in any type of dough (cakes, quiches, puff pastry, pizza, etc.). Prevents formation of air bubbles in dough bases during baking.
- 68803 : Quickly and accurately cuts uniform strips of dough into waves. 9 removable cutting wheels allow you to adjust the desired width
- 68804 : Designed for creating a uniform lattice pattern. Symmetrical lattice effect, ideal for pastries, apple pies, puff pastry, etc. Designed for all types of dough. Let your imagination run wild!
- Ergonomic handle.
- Easy to clean, fully detachable and dishwasher safe.
- Material: ABS with polypropylene handle. BPA free



Cortapastas extensible rizado

Rouleau multicouper · Teigschneider
Dough divider expandable · Corta-massas extensível

| Ref | € | Largo (cm) | U.Venta |
|-------|-------|------------|---------|
| 68247 | 20,00 | 49,5 | 1 |

Cortadores

INOX
Dishwasher



- Fabricados en acero inoxidable 18/10 de gran calidad.
- Ideales para repostería (pasteles, muffins, galletas, fondant, pan, gelatina, pancake, etc.).
- Aseguran un corte 100% preciso y seguro.
- Versátiles: se pueden usar como moldes para hojaldres o decoración de platos.
- Aptos para el lavavajillas.

- Made of high-quality 18/10 stainless steel.
- Ideal for baking (cakes, muffins, biscuits, fondant, bread, jelly, pancake, etc.).
- They ensure 100% accurate and safe cutting.
- Versatile: can be used as moulds for puff pastry or plate decoration.
- Dishwasher safe.

Medidas · Sizes (cm): Ø2 / Ø3 / Ø4 / Ø5 / Ø6 / Ø7 / Ø8 / Ø9 / Ø10

Caja de 9 cortapastas redondos

Boîte de 9 découpoirs ronds unis · 9 Tlg. Teigausstecher, rund, glatt
Set of 9 round dough cutters · Caixa de 9 corta-massas ovais redondos

| Ref | € | Ø (cm) | U.Venta | |
|-------|-------|--------|---------|-----------------|
| 68069 | 28,50 | 4,2 | 1 | Liso · Pain |
| 68070 | 30,90 | 4,2 | 1 | Rizado · Fluted |
| 68091 | 25,80 | 3,5 | 1 | Liso · Pain |
| 68092 | 25,80 | 3,5 | 1 | Rizado · Fluted |



- Conjunto de 5 originales sellos de silicona intercambiables.
- Mango de madera para un perfecto agarre.
- Silicona de máxima calidad. Libre de BPA.
- Garantiza la completa seguridad alimentaria del producto.

- Set de 5 tampons en silicone originaux interchangeables.
- Manche en bois pour une prise en main parfaite.
- Silicone de la plus grande qualité. Sans BPA.
- Garantit une sécurité alimentaire totale du produit.

- Set of 5 original interchangeable silicon stamp.
- Wood handle for perfect grip.
- Top quality silicone. BPA free.
- Guarantees complete food safety of the end product.

El set incluye:

- * Aro ajustable con 6 ranuras que actúan de guía para cortar uniformemente tartas entre Ø 24-30 cm.
- * Cuchillo de hoja dentada diseñado para laminar fácilmente.
- * Pala para coger y servir de forma segura.

The set includes:

- * Adjustable ring with 6 grooves that work as guides for cutting cakes between Ø 24-30 cm.
- * Serrated knife designed to cut layers easily.
- * Spatula for picking up and serving the cake safely.



Sello para galletas Sweet

Tampons pour biscuits · Keksstempel
Biscuit stamp · Carimbos para bolachas

| Ref | € | U.Venta |
|-------|-------|---------|
| 68099 | 13,60 | 1 |



Set cortatartas

Jeu de découpeurs de gâteaux · Tortenausstecher-Set
Cake cutter set · Conjunto de cortador de bolos

| Ref | € | Ø (cm) | Ranuras | U.Venta |
|-------|-------|---------|---------|---------|
| 68527 | 14,30 | 24 - 30 | 6 | 1 |



Aerógrafo

INOX CE

- Ideal para la decoración de tartas, galletas, cupcakes, bombones, etc.
- Permite obtener detalles únicos en creaciones artísticas de repostería.
- El kit contiene: compresor, aerógrafo y tubo conector.
- Compresor con regulador de presión de aire. 0-2 bares y con un caudal de 0-10 L/min.
- Aerógrafo por gravedad de doble acción con aguja de salida de 0,3 mm.
- Depósito de pintura metálico con capacidad de 7 ml.
- Incluye una caja acolchada para almacenar el aerógrafo.

- Idéal pour la décoration des gâteaux, des biscuits, des cupcakes, des chocolats, etc.
- Il vous permet d'obtenir des détails uniques dans les créations de pâtisseries artistiques.
- Le kit contient: compresseur, tube de compresseur, aérographe et connecteur.
- Compresseur avec régulateur de pression d'air. 0-2 bares et avec un débit de 0-10 L / min.
- Aérographe à double action avec aiguille de sortie de 0,3 mm.
- Dépôt de peinture métallique avec une capacité de 7 ml.
- Comprend une boîte rembourrée pour stocker l'aérographe.

- Ideal for the decoration of cakes, cookies, cupcakes, chocolates, etc.
- It allows you to obtain unique details in artistic pastry creations.
- The kit contains: compressor, airbrush and connector tube.
- Compressor with air pressure regulator. 0-2 bars and with a flow of 0-10 l/min.
- Double -action gravity airbrush with 0.3 mm output Wneedle.
- Metallic paint deposit with 7 ml capacity.
- Includes a padded box to store the airbrush.



Aerógrafo con compresor

Aérographe avec compresseur · Airbrush Spritzpistole mit Kompressor
Airbrush with compressor · Aerógrafo com compressor

| Ref | € | W | Presión | Caudal | Capacidad | U.Venta |
|-------|--------|----|-----------|--------------|-----------|---------|
| 69450 | 103,20 | 20 | 0 - 2 bar | 0 - 10 L/min | 7ml | 1 |

Sopletes repostería

INOX 18/10   Dishwasher

- Autoencendido por piezoeléctrico.
- Control ajustable de llama.
- Llama antiretorno.
- Sistema seguro de bloqueo.
- Fácil rellenado de gas butano.

- Auto-childing par piézoélectrique.
- Contrôle de flamme réglable.
- Antiretorno appel.
- Système de blocage sûr.
- Easy Farged avec du gaz butane.

- Self -childing by piezoelectric.
- Adjustable flame control.
- Antiretorno call.
- Safe blockage system.
- Easy stuffed with butane gas.



Válvula recarga gas
Refill valve



Pistola gas repostería

Torche à caraméliser · Gasbrenner
Pastry gas torch · Queimadora a gás para pastelaria

| Ref | € | Capacidad | h(cm) | U.Venta | |
|----------------|--------------|-----------|-------|---------|-------------|
| A 68981 | 19,10 | 5-6 ml | 12,50 | 1 | Micro |
| B 68982 | 31,00 | 19 ml | 17,00 | 1 | Mini |
| C 68983 | 42,20 | 65 ml | 18,00 | 1 | Chef |
| D 68988 | 53,70 | 40 ml | 16,00 | 1 | Profesional |
| E 68969 | 22,30 | 21 ml | 13,00 | 1 | Burn |

Quando el orificio de entrada de oxigeno este descubierta, la llama será más intensa
When the oxygen inlet is uncovered, the flame will be more intense



- Soplete para uso doméstico y profesional.
- Diseño elegante, con cuerpo cilindro de gas butano y acabado metalizado.
- Doble llama para una mayor potencia.
- Botón de encendido automático por piezoeléctrico.
- Intensidad de llama ajustable con sistema de llama antirretorno.
- Ergonómico y de fácil agarre. Práctico, seguro y muy fácil de usar.
- Sistema de bloqueo de seguridad.
- Diseñado para caramelizar el azúcar de las cremas, gratinar, tostas, etc.
- Se suministra sin gas.

- Cabezal soplete profesional a gas butano.
- Encendido instantáneo automático por piezoeléctrico.
- Sistema 360°; permite el uso en cualquier posición y siempre con llama constante.
- Llama ajustable; elige tanto el tamaño como la intensidad.
- Diseño ergonómico y de fácil agarre. Práctico, seguro y muy fácil de usar.
- Preparado para caramelizar el azúcar de las cremas, gratinar, tostas, etc.
- Sistema de bloqueo de seguridad.
- Compatible con todos los recambios de gas butano universales.
- El soplete se ajusta fácilmente y con total seguridad al cartucho de gas.

new

- Torch for domestic and professional use.
- Elegant design, with butane gas cylinder body and metallic finish.
- Double flame for more power.
- Automatic ignition button by piezoelectric ignition.
- Adjustable flame intensity with non-return flame system.
- Ergonomic and easy to grip. Practical, safe and very easy to use.
- Safety locking system.
- Designed for caramelising the sugar in creams, gratins, toasts, etc.
- Supplied without gas.

- Professional butane gas torch head.
- Automatic instantaneous ignition by piezoelectric ignition.
- 360° system; allows use in any position and always with a constant flame.
- Adjustable flame; choose both size and intensity.
- Ergonomic design and easy grip. Practical, safe and very easy to use.
- Prepared for caramelising the sugar in creams, gratins, toasts, etc.
- Safety locking system.
- Compatible with all universal butane gas refills.
- The torch fits easily and securely to the gas cartridge.



Soplete de gas Master

Torche à caraméliser · Brullierbrennen
Blow torch · Queimadora a gás

| Ref | € | Capacidad | U.Venta |
|-------|--------------|-----------|---------|
| 68898 | 22,40 | 18,5 ml | 1 |



Cabezal soplete gas Forza

Torche à caraméliser · Gasbrenner-Aufsatz
Blow torch head · Queimadora a gás

| Ref | € | W | Consumo (g/h) | U.Venta |
|-------|--------------|--------|---------------|---------|
| 68899 | 14,40 | 1,5 Kw | 105 | 1 |



- Para poder utilizar distintos tipos de botellas de gas.
- Pour utiliser différents types de bouteilles de gaz.
- To use different types of gas bottles.



Cabezal soplete gas + adaptador Profesional

Torche à caraméliser + adaptateur · Gasbrenner-Aufsatz + Adapter
Blow torch head + adapter · Queimadora a gás + adaptador

| Ref | € | W | Consumo (g/h) | U.Venta |
|-------|--------------|------|---------------|---------|
| 68974 | 25,40 | 1,65 | 120 | 1 |

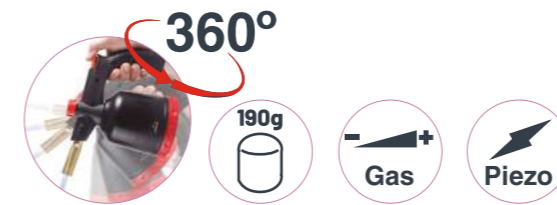

Cabezal gas Profesional

Torche à caraméliser · Brullierbrennen
Blow torch · Queimador a gás

| Ref | € | W | Consumo (g/h) | U.Venta |
|-------|--------------|-----|---------------|---------|
| 68968 | 31,30 | 1,7 | 123 | 1 |

Cabezal soplete gas Profesional

Torche à caraméliser · Gasbrenner-Aufsatz
Blow torch head · Queimadora a gás

| Ref | € | W | Consumo (g/h) | U.Venta |
|-------|--------------|------|---------------|---------|
| 68984 | 16,50 | 1,65 | 120 | 1 |



GAS No incluido
Not included



Válido para gas butano, NO gas natural
Valid for butane gas, NOT natural gas

- Este cartucho contiene gas licuado a alta presión (LPG). Gas extremadamente inflamable. Mantenga el cartucho de gas fuera del alcance de los niños. No perforar el cartucho. Emplee el cartucho en un lugar ventilador. No inhale el gas. No deje el cartucho en un lugar que no sea estable. Mantener el cartucho de gas butano alejado de las llamas y el fuego, no exponga el cartucho al contacto directo con la luz solar o a temperaturas superiores a 40°C (104°F). Este cartucho de gas no se puede recargar. Asegúrese de que el cartucho este vacío antes de deshacerse de él.

new

- The cartridge contains high pressure liquefied petroleum gas (LPG). Highly flammable gas. Keep the cartridge out of reach of children. Do not puncture the cartridge. Use the cartridge in a well-ventilated place. Do not inhale the gas. Do not leave the cartridge in a place that is unstable. Keep the butane gas cartridge away from flames and fire. Do not expose the cartridge to direct sunlight or temperatures above 40°C (104°F). The gas cartridge is not refillable. Make sure the cartridge is empty before disposing of it.



Cartucho de gas

Cartouche de gaz · Gaskartusche
Gas cartridge · Cartucho de gás

| Ref | € | ml | g | Pack | U.Venta |
|----------------|--------------|----------|----------|------|---------|
| A 68941 | 2,60 | 420 | 220 | 1 | 1 |
| B 68947 | 10,10 | 420 (x4) | 220 (x4) | 4 | 1 |

- Quemador de azúcar eléctrico redondo con soporte.
- Diseñado para aplicaciones en cocina y repostería profesional.
- Ideal para caramelizar crema.
- Se calienta muy rápido.

- Brûleur de sucre électrique rond avec soutien.
- Conçu pour les applications dans une cuisine professionnelle et des pâtisseries.
- Idéal pour caraméliser la crème.
- Il se réchauffe très vite.

- Round electric sugar burner with support.
- Designed for applications in professional kitchen and pastries.
- Ideal to caramelize cream.
- It heats up very fast.



Incluye soporte
Includes support

Quemador eléctrico redondo

Fer à caraméliser électrique rond · Karamellisierer rund
Round electric caramélizer · Queimador eléctrico redondo

| Ref | € | W | Ø (cm) | U.Venta |
|-------|---------------|------|--------|---------|
| 68651 | 117,80 | 650 | Ø10 | 1 |
| 68652 | 136,00 | 1000 | Ø12 | 1 |



Dosificadores

INOX 18/10
Dishwasher

- Ideal para rellenar o decorar platos con salsas y cremas calientes y frías.
- Sistema de palanca para un caudal ajustable; práctico y preciso.
- Sistema antigoteo y antisalpicaduras.
- Mango con diseño ergonómico que permite el manejo con una sola mano.
- Fácil desmontaje para una sencilla limpieza. Apto para el lavavajillas.

- Idéal pour remplir ou décorer les plats avec des sauces et des crèmes chaudes et froides.
- Système de levier pour un débit réglable; pratique et précis.
- Système anti-tôte et antisalpaduras.
- Mango avec conception ergonomique qui permet de manipuler d'une seule main.
- Démontage facile pour un nettoyage simple. Compatible pour le lave-vaisselle.

- Perfect for filling or decorating dishes with hot or cold sauces and cream.
- Its lever system for controlling the flow is practical and precise.
- Anti-drip and anti-splash system.
- The ergonomic handle means it can be used with just one hand.
- It's easy to disassemble for easy cleaning and it's dishwasher safe.

SI PE
Silicone Polyethylene
BPA free

Dosificador Red
Entonnoir à decor · Dosierer
Portionner · Dosificador

| Ref | € | cm | h(cm) | L | U.Venta |
|-------|-------|-------|-------|-----|---------|
| 67026 | 12,10 | 16x11 | 18 | 1,0 | 1 |



Marcas de medición (ml - cup)
Measuring marks (ml - cup)

Sistema de gatillo para un caudal ajustable
Trigger system for an adjustable flow

Dosificador Inox
Entonnoir à decor · Dosierer
Portionner · Dosificador

| Ref | € | Ø (cm) | h(cm) | L | U.Venta |
|-------|-------|--------|-------|-----|---------|
| 67150 | 63,30 | 19 | 27 | 2,0 | 1 |



Sistema de gatillo para un caudal ajustable
Trigger system for an adjustable flow

Incluye soporte y un platillo antigoteo
Includes support and a drip dish

Dosificador Ration
Entonnoir à decor · Dosierer
Portionner · Dosificador

| Ref | € | L | U.Venta |
|-------|-------|------|---------|
| 67000 | 91,00 | 2,00 | 1 |



Sistema de gatillo para un caudal ajustable
Trigger system for an adjustable flow

Incluye soporte
Includes support

Sifones



Dishwasher

- Robusto y duradero.
- Marcaje de llenado grabado en el exterior del cuerpo.
- Versátil: Diseñado para espumas frías y espumas calientes.
- Incluye 3 boquillas con formas decorativas.
- Funciona con cargas de gas (N2O).
- Cepillo limpiador para facilitar la limpieza.

- Robuste et durable.
- Marquage de remplissage gravé à l'extérieur du corps.
- Versatile : conçu pour des préparations froides et chaudes.
- Inclut 3 douilles des formes décoratives.
- Fonctionne avec des cartouches de gaz (N2O).
- Brosse pour faciliter le nettoyage.

- Robust and durable.
- Embossed filling marks on the outside.
- Versatile: designed for whipping up hot or cold foams.
- Includes 3 nozzles with decorative shapes.
- Charged with gas cartridges (N2O).
- Cleaning brush for easy cleaning.

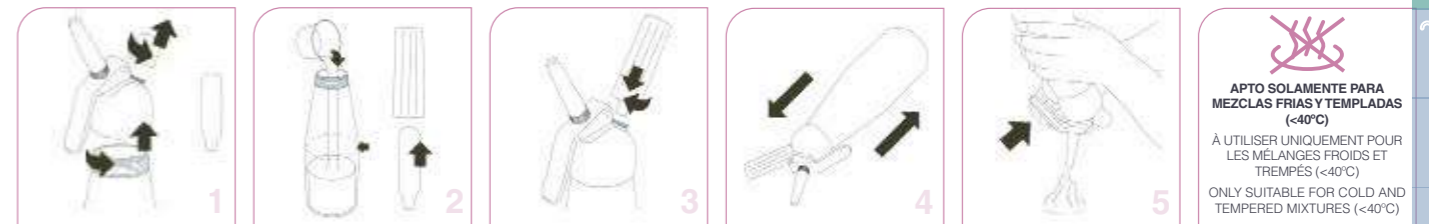

APTO SOLAMENTE PARA MEZCLAS FRÍAS Y TEMPLADAS (<40°C)
À UTILISER UNIQUEMENT POUR LES MÉLANGES FROIDS ET TREMPÉS (<40°C)
ONLY SUITABLE FOR COLD AND TEMPERED MIXTURES (<40°C)

EXCLUSIVAMENTE PARA USO ALIMENTICIO
EXCLUSIVELY FOR FOOD USE



Cargas de sifón

Cartouches N₂O pour siphon · N₂O Kapsel für Sahnebereiter
N₂O cream charger · Botijas de sifão N₂O

| Ref | € | Botellas | Peso (g) | U.Venta |
|-------|-------|----------|----------|---------|
| 68402 | 8,50 | 10 | 8 | 1 |
| 68403 | 19,90 | 24 | 8 | 1 |

Sifón Epicure

Siphon à crème · Sahnebereiter
Cream whipper · Sifão creme

| Ref | € | Ø (cm) | L | U.Venta |
|-------|--------|--------|------|---------|
| 68300 | 111,00 | 9,0 | 0,50 | 1 |
| 68301 | 126,00 | 9,0 | 1,00 | 1 |

Temperatura de uso · Use temperature
min = +5°C / max = +70°C

Sifón Mix

Siphon à crème · Sahnebereiter
Cream whipper · Sifão creme

| Ref | € | Ø (cm) | L | U.Venta |
|-------|-------|----------|------|---------|
| 68404 | 85,00 | 7,8x25 | 0,50 | 1 |
| 68405 | 97,70 | 9,3x32,5 | 1,00 | 1 |

Temperatura de uso · Use temperature
min = +5°C / max = +40°C

PBT plastci

Aluminium

Sifón White

Siphon à creme · Sahnebereiter
Cream whipper · Sifão creme

| Ref | € | Ø (cm) | L | U.Venta |
|-------|-------|--------|------|---------|
| 68502 | 41,70 | 9x27 | 0,25 | 1 |
| 68500 | 49,40 | 9x31 | 0,50 | 1 |
| 68501 | 55,10 | 11x36 | 1,00 | 1 |

Temperatura de uso · Use temperature
min = +5°C / max = +40°C

Sifón black

Siphon à creme · Sahnebereiter
Cream whipper · Sifão creme

| Ref | € | Ø (cm) | L | U.Venta |
|-------|-------|----------|------|---------|
| 68604 | 52,10 | 7,8x27,3 | 0,50 | 1 |
| 68605 | 57,40 | 9,3x32,5 | 1,00 | 1 |

Temperatura de uso · Use temperature
min = +5°C / max = +40°C



NUNCA ponga los sifones al baño maría, puede producirse una explosión con graves consecuencias.

NE JAMAIS mettez les siphons au bain marie car une explosion pourrait avoir lieu et provoquer de graves conséquences.

NEVER put siphons in a water bath, as this may cause an explosion with serious consequences.



Mangas repostería

PP Polipropylene
INOX 18/10 Dishwasher
BPA free

- Manga pastelera para decorar y personalizar tus postres preferidos.
- Manga de alta calidad. Soporta altas temperaturas.
- Resistente y reutilizable.
- Apta para el lavavajillas.
- Manga pastelera pour décorer et personnaliser vos desserts préférés.
- Manga de haute qualité. Il prend en charge des températures élevées.
- Résistant et réutilisable.
- Convient au lave-vaisselle.
- Pastelera manga to decorate and customize your favorite desserts.
- High quality manga. It supports high temperatures.
- Resistant and reusable.
- Suitable for dishwasher.

Manga repostería
Poche à décorer · Spritzbeutel
Pastry bag · Manga de pastelería

| Ref | € | cm | Ø (cm) | U.Venta |
|---------|-------|----|--------|---------|
| A 68972 | 7,50 | 20 | 20x30 | 1 |
| B 68973 | 12,70 | 30 | 25x45 | 1 |



SI Silicone
PP Polipropylene

Manga repostería + boquillas
Poche à décorer · Spritzbeutel
Pastry bag · Manga de pastelería

| Ref | € | ml | h (cm) | U.Venta |
|-------|------|-----|--------|---------|
| 68971 | 7,80 | 800 | 30 | 1 |



Boquillas · Nozzles
Ø2x3 cm

Boca · Mouth: Ø2,5 cms.

Manga repostería
Poche à décorer · Spritzbeutel
Pastry bag · Manga de pastelería

| Ref | € | h(cm) | L | U.Venta |
|-------|-------|-------|------|---------|
| 68930 | 5,20 | 30 | 0,57 | 6 |
| 68935 | 6,20 | 35 | 1,10 | 6 |
| 68940 | 6,80 | 40 | 1,45 | 6 |
| 68945 | 8,00 | 45 | 2,30 | 6 |
| 68950 | 8,80 | 50 | 2,50 | 6 |
| 68955 | 9,80 | 55 | 3,40 | 6 |
| 68960 | 11,00 | 60 | 5,50 | 6 |
| 68965 | 11,50 | 65 | 6,50 | 6 |
| 68970 | 13,90 | 70 | 7,50 | 6 |



Boquillas · Nozzles
Ø2,5x4,5 cm

LDPE
Polyethylene
Se adaptan a cualquier tipo de boquilla
No emplear con alimentos a temperaturas superiores a 60°C
Adapts to any kind of nozzle. Not for use with food at temperatures above 60°C

Manga repostería desechables
Poche à décorer jetable · Einweg Spritzbeutel
Non-returnable pastry bags · Mangas descartaveis

| Ref | € | Piezas | AxB (cm) | U.Venta |
|-------|-------|--------|----------|---------|
| 68937 | 15,00 | 100 | 35x21 | 1 |
| 68939 | 21,60 | 100 | 40x22 | 1 |
| 68954 | 32,40 | 100 | 55x30 | 1 |
| 68964 | 37,90 | 100 | 65x32 | 1 |

Galga 280 = 70 micras (µm)

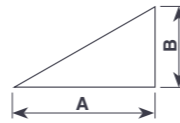

Boquillas

INOX 18/10 Dishwasher

Set de 6 boquillas redonda

Ensemble 6 douilles unies · Lochtüllensatz 6-tlg. rund
6 plain tube set · Conjunto de 6 boquillas redonda

| Ref | € | Ø (mm) | U.Venta |
|-------|-------|--------|---------|
| 68908 | 26,10 | 8 | 1 |
| 68910 | 26,10 | 10 | 1 |
| 68912 | 26,10 | 12 | 1 |
| 68915 | 26,10 | 15 | 1 |



Set de 6 boquillas redonda Size

Ensemble 6 douilles unies · Lochtüllensatz 6-tlg.rund
6 plain tube set · Conjunto de 6 boquillas redonda

| Ref | € | Forma (mm) |
|-------|-------|-----------------------|
| 68996 | 17,00 | Redonda 4/5/6/8/10/12 |

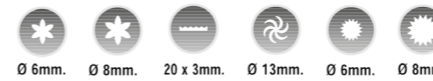

Set de 6 boquillas estrella

Ensemble 6 douilles cannelées · Lochtüllensatz 6-tlg. Stern
6 star tube set · Conjunto de 6 boquillas estrella

| Ref | € | Ø (mm) | U.Venta |
|-------|-------|--------|---------|
| 68928 | 26,10 | 8 | 1 |
| 68900 | 26,10 | 10 | 1 |
| 68932 | 26,10 | 12 | 1 |
| 68934 | 26,10 | 15 | 1 |

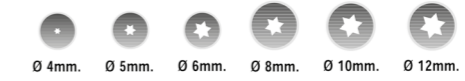

Set de 6 boquillas estrella Size

Ensemble 6 douilles cannelées · Tüllensatz 6-tlg., Stern
6 star tube set · Conjunto de 6 boquillas estrella

| Ref | € | Forma (mm) |
|-------|-------|------------------------|
| 68997 | 17,00 | Estrella 4/5/6/8/10/12 |

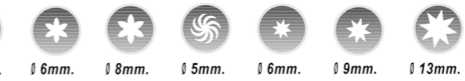

Set de 6 boquillas rosa

Ensemble 6 douilles cannelées fermes · Tüllensatz 6-tlg. Stern
6 close star tube set · Conjunto de 6 boquillas rosa

| Ref | € | Ø (mm) | U.Venta |
|-------|-------|--------|---------|
| 68948 | 26,10 | 8 | 1 |
| 68980 | 26,10 | 10 | 1 |
| 68942 | 26,10 | 12 | 1 |
| 68985 | 26,10 | 15 | 1 |

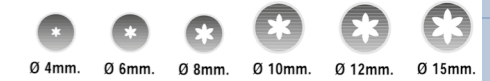

Set de 6 boquillas rosa Size

Ensemble 6 douilles cannelées fermes · Tüllensatz 6-tlg.
6 close star tube set · Conjunto de 6 boquillas rosa

| Ref | € | Forma (mm) |
|-------|-------|---------------------|
| 68993 | 17,00 | Rosa 4/6/8/10/12/15 |



Set de 6 boquillas variadas

Ensemble 6 douilles variées · Tüllensatz 6-tlg. sortiert
6 assorted tube set · Conjunto de 6 boquillas variadas

| Ref | € | Forma (mm) |
|-------|-------|--------------------------------------|
| 68998 | 17,00 | Rosa 6/8 Cinta 20x3 Cinta 20x3 |



Juego 6 boquillas rusas

Ensemble 6 douilles russes · 6-Tlg Russian Tüllensatz
Set 6 Russian decorating nozzles · Conj. 6 boquillas russo

| Ref | € | Ø (cm) | h (cm) | U.Venta |
|---------|-------|--------|--------|---------|
| A 68892 | 8,60 | 3,5 | 4,5 | 6 |
| B 68893 | 14,90 | 3,0 | 6,2 | 1 |

Set de 6 boquillas variadas Size

Ensemble 6 douilles variées · Tüllensatz 6-tlg. sortiert
6 assorted tube set · Conjunto de 6 boquillas variadas

| Ref | € | Forma (mm) |
|-------|-------|----------------------------------|
| 68999 | 17,00 | Rosa 6/8 Hélice 5 Hélice 5 |



Set de 24 boquillas

24 pcs. douilles assorties · 24 tlg. Tüllensortiment
24 pcs. anozzles set · Conjunto de 24 boquillas

| Ref | € | Piezas | U.Venta |
|-------|-------|--------|---------|
| 68994 | 15,60 | 24 | 1 |

Set de 6 boquillas relleno

Ensemble 2 douilles petit chou · Einfülltüllensatz 2-tlg.
2 Bismark tube set · Conjunto de 2 boquillas relleno

| Ref | € | Forma (mm) |
|-------|-------|-------------|
| 68992 | 11,20 | Relleno 4/8 |



INOX

Juego de boquillas decoración

Deuilles assorties décoration · Dekorations-Tüllensatz
Decorating nozzles · Jogo de boquillas decoração

| Ref | € | Piezas | U.Venta |
|-------|-------|--------|---------|
| 68991 | 17,00 | 26 | 1 |

Pistolas

INOX
18/10

- Ideal para salsas, cremas, aceites, aliños, vinagretas y todo tipo de condimentos líquidos.
- Dibuja, adorna y personaliza con estilo tus platos.

- Idéal pour les sauces, les crèmes, les huiles, les assaisonnements, les vinaigrettes et tout type de condiments liquides.
- Il dessine, décore et personnalise les plats.

- Ideal for sauces, creams, oils, dressings, vinaigrettes and all kinds of liquid condiments.
- Draw, decorate and personalize your dishes with style.



Pistola decoración repostería

Pistolet Décoration Pâtisserie · Pistole für Tüllensätze
Pastry Decoration Gun · Pistola Decoração Pastelaria

| Ref | € | L | U.Venta |
|-------|-------|------|---------|
| 61407 | 33,50 | 0,25 | 1 |



Juego pistola repostería

Pistolet pour pâtisserie · Pistole für Tüllensätze
Cookie press cum icing set · Jogo de pistola pastelaria

| Ref | € | L | U.Venta |
|-------|-------|------|---------|
| 68989 | 49,40 | 0,25 | 1 |

Botellas biberón

PP PE
Polypropylene Polyethylene
BPA free

- Ideal para salsas, cremas, aceites, aliños, vinagretas y todo tipo de condimentos líquidos.
- Dibuja, adorna y personaliza con estilo tus platos.

- Idéal pour les sauces, les crèmes, les huiles, les vinaigrettes, les vinaigrettes et toutes sortes de condiments liquides.
- Dessinez, ornez et personnalisez vos plats.

- Ideal for sauces, creams, oils, dressings, vinaigrettes and all kinds of liquid condiments.
- Draw, adorn and customize your dishes.



SI
Silicone
BPA free

Botella biberón Tri

Bouteille biberon · Dosierflasche
Squeeze bottle · Garrafa

| Ref | € | Ø (cm) | L | U.Venta |
|-------|------|--------|------|---------|
| 61974 | 4,10 | 7x20 | 0,45 | 6 |
| 61977 | 4,40 | 7x26 | 0,70 | 6 |

Botella biberon Push

Bouteille biberon · Dosierflasche
Squeeze bottle · Garrafa

| Ref | € | Ø (cm) | L | U.Venta |
|-------|------|--------|------|---------|
| 61978 | 4,60 | 6x20 | 0,50 | 1 |
| 61979 | 4,70 | 7x20 | 0,60 | 1 |
| 61980 | 4,90 | 7x26 | 0,70 | 1 |

Botella decoración

Biberon à décorer · Dekorierflasche
Decorating pen · Garrafa decoração

| Ref | € | Ø (cm) | L | U.Venta |
|-------|------|--------|------|---------|
| 64457 | 9,80 | 5,5x16 | 0,14 | 1 |

Baño maría



Abertura lateral para llenar de agua (1,0 L)

Capacidad chocolate: 1,0 L

Side opening to introduce water (1,0 L)

Chocolatecapacity: 1,0 L



INOX
18/10



Cazo baño maría

Casserole bain marie · Stielkasserolle für Wasserbad
Bain-marie saucepan · Çaçarol para banho-maria

| Ref | € | Ø (cm) | h (cm) | L | U.Venta |
|-------|-------|--------|--------|------|---------|
| 62600 | 30,70 | 16 | 10,0 | 1,00 | 1 |



INOX
18/10



Baño maría chocolate Black

Bain marie de chocolat · Bain Marie topf für Schokolade
Chocolate bain marie · Banho-maria chocolate

| Ref | € | W | L | Temperatura | Medidas | U.Venta |
|-------|-------|----|-----|-------------|-----------------|---------|
| 69317 | 42,80 | 50 | 1,0 | 40-50°C | 29 x 22 x 12 cm | 1 |



INOX
18/10



Baño maría chocolate White

Bain marie de chocolat · Bain Marie topf für Schokolade
Chocolate bain marie · Banho-maria chocolate

| Ref | € | W | L | Temperatura | Medidas | U.Venta |
|-------|-------|----|-----|-------------|-----------------|---------|
| 69617 | 77,60 | 80 | 1,5 | 60°C | 22,6x26x14,3 cm | 1 |

- Cazo de doble pared para cocinar al baño maría.
- Fabricado en acero inoxidable 18/10 de máxima calidad.
- Doble pared: evita que el agua entre en contacto con el alimento.
- Abertura en el lateral para un llenado práctico y cómodo.
- Ideal para derretir chocolate, caramelo, emulsionar salsas, fundir mantequilla, etc.
- Mango de baquelita termorresistente.
- Apto para todos los fuegos (incluido la inducción).
- Fácil de usar y limpiar. Se puede lavar en lavavajillas.

- Double wall saucepan to cook in the water bath.
- Made of stainless steel 18/10 of maximum quality.
- Double wall: prevents water from contacting food.
- Opening on the side for a practical and comfortable filling.
- Ideal for melting chocolate, caramel, emulsifying sauces, melt butter, etc.
- Thermor resistant baquelita mango.
- Suitable for all fires (including induction).
- Easy to use and clean. It can be washed in a dishwasher.



- Recipiente eléctrico con cazo desmontable de acero inoxidable de gran calidad.
- Dos funciones: fundir el chocolate (40-50°C) y mantenerlo caliente.
- Botón giratorio con 3 posiciones: apagar, fundir y calentar.
- Mantiene la temperatura constante a 40 - 50 grados.

- Récipient électrique avec acier inoxydable amovible en acier inoxydable de haute qualité.
- Deux fonctions: Faire fondre le chocolat (40-50°C) et le garder chaud.
- Bouton rotatif avec 3 positions: éteignez, faites fondre et chauffez.
- Maintenir la température constante à 40 à 50 degrés.
- Electric container with removable stainless steel of high quality stainless steel.

- Two functions: melt the chocolate (40-50°C) and keep it hot.
- Rotating button with 3 positions: turn off, melt and heat.
- Maintain the constant temperature at 40 - 50 degrees.

- Perfecta para elaborar coberturas de alta calidad y mantenerlas a la temperatura deseada durante horas.
- Ideal para la obtención de un glaseado brillante para pasteles, tartas, cake pops, muffins, etc.
- Contenedor GN1/6 (1,50L) y tapa extraíble de acero inoxidable 18/10 para garantizar una rápida y efectiva limpieza (aptos para el lavavajillas).
- Regulación de temperatura por termostato de 0°C a 60°C.
- Calentamiento 3D; el calor se distribuye de manera uniforme por toda la superficie del recipiente.
- Luz indicadora, se enciende tan pronto como se alcanza la temperatura deseada.
- Compatible con cubetas GN1/6 de Lacor

- Perfect to prepare high quality coverage and keep them at the desired temperature for hours.
- Ideal for obtaining a brilliant glaze for cakes, cakes, cake pops, muffins, etc.
- GN1/6 (1.50L) container and removable stainless steel cover 18/10 to guarantee rapid and effective cleaning (suitable for dishwasher).
- Temperature regulation by thermostat from 0°C to 60°C.
- 3D heating; The heat is distributed uniformly throughout the surface of the container.
- Indicator light, comes as soon as the desired temperature is reached.
- Compatible with Gn1/6 buckets from Lacor

Rejillas repostería



CRO
Cromado
Chrome
Dishwasher

INOX
18/10
Dishwasher

Rejilla para repostería redonda

Grille pâtisserie · Kuchengitter rund
Pastry rack · Grelha para pasteleria

Portartas Inox

Gueridon pâtisier · Kuchenplatte
Cake stand · Porta-tartes

| Ref | € | Ø (cm) | U.Venta |
|-------|------|--------|---------|
| 66916 | 6,40 | 28 | 6 |
| 66926 | 6,50 | 32 | 6 |
| 66917 | 8,50 | 36 | 6 |
| 66927 | 8,70 | 43x30 | 6 |

| Ref | € | Ø (cm) | U.Venta |
|-------|--------|--------|---------|
| 67030 | 178,10 | 30 | 1 |



MF
Melamine
Dishwasher
BPA free

INOX
18/10
Dishwasher

INOX
18/10
Dishwasher

Portartas Melamina

Gueridon pâtisier · Kuchenplatte
Cake stand · Porta-tartes

Pinza repostería

Pince à gateau · Gebäck-Tortenzange
Cake tong · Pinça pasteleria

Pinza repostería con anillas

Pince à gateau · Gebäck-Tortenzange
Cake tong · Pinça pasteleria

| Ref | € | Ø (cm) | h(cm) | U.Venta |
|-------|-------|--------|-------|---------|
| 63586 | 33,40 | 30 | 9,0 | 4 |

| Ref | € | Largo (cm) | U.Venta |
|-------|-------|------------|---------|
| 62317 | 12,00 | 20 | 1 |

| Ref | € | Largo (cm) | U.Venta |
|-------|------|------------|---------|
| 68008 | 6,10 | 16 | 6 |

Porción de tarta
Slice of cake

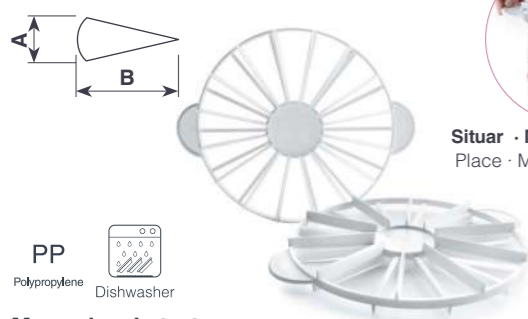

Situar · Marcar · Repartir
Place · Mark · Partitioning

Diseñada para recoger varias galletas a la vez.
Designed to scoop up several biscuits at the same time.

Nylon, no raya
Nylon, not scratch,

PP
Polypropylene
Dishwasher

Marcador de tartas

Marqueur à gateaux · Tortenteiler
Cake marker · Marcador de bolos

| Ref | € | Ø (cm) | AxB (cm) | Porciones | U.Venta |
|-------|------|--------|---------------------|-----------|---------|
| 68511 | 9,00 | 27 | 8,5x13,5 / 7,5x13,5 | 10 / 12 | 1 |
| 68513 | 9,00 | 27 | 6x13,5 / 5,5x13,5 | 14 / 16 | 1 |

Espátula para galletas Tasty

Spatule à biscuits · Spachtel für Kekse
Biscuit spatula · Espátula para biscoitos

| Ref | € | cm | Largo (cm) | U.Venta |
|-------|------|---------|------------|---------|
| 68805 | 5,10 | 16,8x11 | 32,5 | 1 |



INOX
18/10
Dishwasher

- Utensilio de repostería perfecto para formar bolas de helado sin esfuerzo.
- Mecanismo de estilo guillotina para extraer y servir fácilmente bolas de helado.
- Gran resistencia y durabilidad.
- Fácil de usar y limpiar. Apto para lavavajillas.

- Ustensile de pâtisserie parfait pour faire des boules de glace sans efforts.
- Mécanisme de style guillotine pour extraire et servir facilement les boules de glace.
- Grande résistance et durabilité.
- Facile à utiliser et à nettoyer. Apte pour le lave-vaisselle.

- A perfect confectionery utensil for making balls of ice cream effortlessly.
- Guillotine style mechanism for easily scooping and serving balls of ice cream.
- Very strong and durable.
- Easy to use and clean. Dishwasher safe.

Fundición de inoxidable
Stainless cast iron



Fundición de inoxidable
Stainless cast iron



Racionador Profesional

Cuillère à glace professionnel · Eisportionierer, Profi
Professional ice cream scoop · Racionador profesional

Racionador oval Profesional

Cuillère à glace ovale · Eisportionierer
Ice cream scoop oval · Racionador oval

Racionador Basic

Cuillère à glace · Eisportionierer
Ice cream scoop · Racionador de gelado

| Ref | € | Bolas/L | Ø (mm) | U.Venta |
|-------|-------|---------|--------|---------|
| 67038 | 34,40 | 50 | 39 | 10 |
| 67043 | 34,40 | 40 | 44 | 10 |
| 67045 | 35,30 | 36 | 46 | 10 |
| 67047 | 35,30 | 30 | 48 | 10 |
| 67049 | 35,30 | 24 | 50 | 10 |
| 67052 | 36,60 | 20 | 53 | 10 |
| 67055 | 36,60 | 16 | 56 | 10 |
| 67058 | 36,60 | 13 | 59 | 10 |
| 67062 | 36,60 | 12 | 63 | 10 |
| 67065 | 36,60 | 10 | 66 | 10 |
| 67069 | 36,70 | 8 | 70 | 10 |
| 67074 | 36,70 | 7 | 75 | 10 |
| 67084 | 36,70 | 5 | 85 | 10 |

| Ref | € | Bolas/L | Ø (mm) | U.Venta |
|-------|-------|---------|--------|---------|
| 67153 | 36,40 | 40 | 10 | |
| 67158 | 36,40 | 30 | 10 | |
| 67163 | 36,40 | 20 | 10 | |

| Ref | € | Bolas/L | Ø (mm) | U.Venta |
|-------|-------|---------|--------|---------|
| 67039 | 18,30 | 50 | 39 | 10 |
| 67044 | 18,30 | 40 | 44 | 10 |
| 67046 | 18,30 | 36 | 46 | 10 |
| 67048 | 18,30 | 30 | 48 | 10 |
| 67050 | 18,30 | 24 | 50 | 10 |
| 67053 | 18,60 | 20 | 53 | 10 |
| 67056 | 19,30 | 16 | 56 | 10 |
| 67059 | 19,30 | 13 | 59 | 10 |
| 67063 | 19,30 | 12 | 63 | 10 |
| 67066 | 19,70 | 10 | 66 | 10 |
| 67070 | 19,70 | 8 | 70 | 10 |

AL
Aluminium



Racionador de helado aluminio

Cuillère à glace aluminium · Eisportionierer, Aluminium
Aluminium ice cream scoop · Racionador de gelado aluminio

| Ref | € | Bolas/L | Ø (mm) | U.Venta |
|-------|------|---------|--------|---------|
| 67090 | 9,90 | 50 | 50 | 1 |

Copa baja

Coupe à glace basse · Eiskelch
Ice cream cup · Taça de gelado

| Ref | € | Bolas/L | cm | U.Venta |
|-------|------|---------|-------|---------|
| 67002 | 4,90 | 5,5 | Ø9x12 | 12 |

Moldes y aros

Moulds and rings



Colección Black

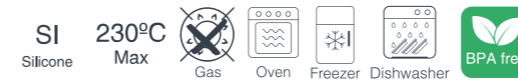

100%
Platinum
silicone

- Molde 100% de silicona platino para procesos de horneado y congelación.
 - Antiadherente, flexible, duradero, higiénico y fácil de limpiar.
 - Soporta fuertes cambios de temperatura.
 - No transmite sabores ni olores.
 - Permite desmoldar fácil y perfectamente los alimentos.
- Moule de silicone en platine 100% pour les processus de cuisson et la congélation.
 - Anticiting, flexible, durable, hygiénique et facile à nettoyer.
 - Il prend en charge de forts changements de température.
 - Il ne transmet pas les saveurs ou les odeurs.
 - Il permet des aliments facilement et parfaitement imprégnés.
- 100% platinum silicone mold for baking processes and freezing.
 - Antiating, flexible, durable, hygienic and easy to clean.
 - It supports strong temperature changes.
 - It does not transmit flavors or odors.
 - It allows to easily and perfectly unmold food.

Antiadherentes, flexibles, duraderos, higiénicos y fáciles de limpiar
Non-stick, flexible, long-lasting, hygienic and easy to clean



Briochette 24 cavidades

Briochette 24 cavités · Briocheform für 24 Madaleine
Briochette 24 moulds · Briochette 24 cavidades

| Ref | € | Ø (cm) | h(cm) | ml | U.Venta |
|-------|--------|--------|-------|----|---------|
| 66760 | 102,90 | 8 | 3,5 | 84 | 1 |



Semiésferica 28 cavidades

Hemisphere 28 cavités · Halbkugelform für 28 Madaleine
Half-spheres 28 moulds · Semi-esférica 28 cavidades

| Ref | € | Ø (cm) | h(cm) | ml | U.Venta |
|-------|--------|--------|-------|----|---------|
| 66761 | 102,90 | 7 | 3,5 | 90 | 1 |



Semiésferica 60 cavidades

Hemisphere 60 cavités · Halbkugelform für 60 Madaleine
Half-spheres 60 moulds · Semi-esférica 60 cavidades

| Ref | € | Ø (cm) | h(cm) | ml | U.Venta |
|-------|--------|--------|-------|----|---------|
| 66747 | 101,00 | 4,2 | 2 | 10 | 1 |

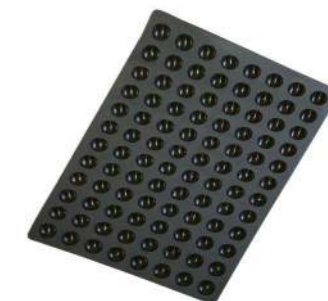

Mini semiésferica 96 cavidades

Mini Hemisphere 96 cavités · Mini Halbkugelform für 96 Madaleine
Mini Half-spheres 96 moulds · Mini semi-esférica 96 cavidades

| Ref | € | Ø (cm) | h(cm) | ml | U.Venta |
|-------|--------|--------|-------|----|---------|
| 66762 | 102,90 | 3,5 | 1,75 | 11 | 1 |





Madalena 44 cavidades

Madeleine 44 cavités · Madeleineform für 44 Madaleine
Madeleine 44 moulds · Madalena 44 cavidades

| Ref | € | cm | h(cm) | ml | U.Venta |
|-------|--------|---------|-------|----|---------|
| 66763 | 102,90 | 7,7x4,5 | 1,8 | 30 | 1 |



Florentina 15 cavidades

Florentine 15 cavités · Florentinerform für 15 Madaleine
Florentina 15 moulds · Florentina 15 cavidades

| Ref | € | Ø (cm) | h(cm) | ml | U.Venta |
|-------|--------|--------|-------|-----|---------|
| 66748 | 101,00 | 10 | 2 | 100 | 1 |



Mini Muffin 70 cavidades

Mini muffin 70 cavités · Mini Muffinform klein für 70 Madaleine
Mini muffin 70 moulds · Mini muffin 70 cavidades

| Ref | € | Ø (cm) | h(cm) | ml | U.Venta |
|-------|--------|--------|-------|----|---------|
| 66765 | 102,90 | 4,5 | 3 | 40 | 1 |



Florentina 40 cavidades

Florentine 40 cavités · Florentinerform für 40 Madaleine
Florentina 40 moulds · Florentina 40 cavidades

| Ref | € | Ø (cm) | h(cm) | ml | U.Venta |
|-------|--------|--------|-------|----|---------|
| 66764 | 102,90 | 6 | 1,1 | 25 | 1 |



Muffin 24 cavidades

Muffin 24 cavités · Muffinform für 24 Madaleine
Muffin 24 moulds · Muffin 24 cavidades

| Ref | € | Ø (cm) | h(cm) | ml | U.Venta |
|-------|--------|--------|-------|-----|---------|
| 66766 | 102,90 | 7 | 4 | 120 | 1 |



Tartaleta 60 cavidades

Tartalette 60 cavités · Torteileitform für 60 Madaleine
Tartlet 60 moulds · Tarte 60 cavidades

| Ref | € | Ø (cm) | h(cm) | ml | U.Venta |
|-------|--------|--------|-------|----|---------|
| 66767 | 102,90 | 4,5 | 1 | 10 | 1 |



Pirámide 35 cavidades

Pyramide 35 cavités · Pyramidenform für 35 Madaleine
Pyramid 35 moulds · Pirámide 35 cavidades

| Ref | € | cm | h(cm) | ml | U.Venta |
|-------|--------|---------|-------|----|---------|
| 66768 | 102,90 | 6,5x6,5 | 3,5 | 61 | 1 |



Mini cake 30 cavidades

Mini cake 30 cavités · Mini Kuchenform für 30 Madaleine
Mini cake 30 moulds · Mini cake 30 cavidades

| Ref | € | cm | h(cm) | ml | U.Venta |
|-------|--------|------|-------|-----|---------|
| 66769 | 102,90 | 10x5 | 3 | 110 | 1 |

Colección Pastryflex



BANDEJA GASTRONORM
Uso de 3 moldes

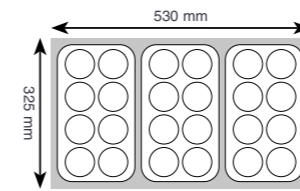

BANDEJA 60x40
Uso de 4 moldes

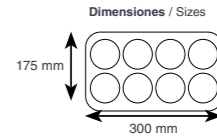
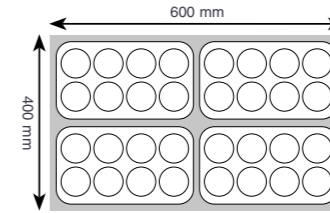

Cilindro 8 cavidades

Cylindre 8 cavités · Zylinderform für 8 Madeleine
Cylindre 8 moulds · Cilindro 8 cavidades

| Ref | € | Ø (cm) | h(cm) | ml | U.Venta |
|-------|-------|--------|-------|----|---------|
| 66807 | 16,00 | 6 | 3,5 | 90 | 1 |



Madalena pequeña 15 cavidades

Petite madeleine 15 cavités · Madeleineform, Klein, für 15 Madeleine
Small madeleine 15 moulds · Madalena pequena 15 cavidades

| Ref | € | cm | h(cm) | ml | U.Venta |
|-------|-------|-------|-------|----|---------|
| 66816 | 16,00 | 4,2x3 | 1,15 | 10 | 1 |



Madalena 9 cavidades

Madeleine 9 cavités · Madeleineform 9 Madeleine
Madeleine 9 moulds · Madalena 9 cavidades

| Ref | € | cm | h(cm) | ml | U.Venta |
|-------|-------|---------|-------|----|---------|
| 66817 | 16,00 | 7,8x4,5 | 1,7 | 30 | 1 |



Briochette cónico 6 cavidades

Briochette 6 cavités · Briocheform 6 Madeleine
Briochette 6 moulds · Briochette 6 cavidades

| Ref | € | Ø (cm) | h(cm) | ml | U.Venta |
|-------|-------|--------|-------|-----|---------|
| 66819 | 16,00 | 10,5 | 2 | 110 | 1 |



Briochette 6 cavidades

Briochette 6 cavités · Briocheform 6 Madeleine
Briochette 6 moulds · Briochette 6 cavidades

| Ref | € | Ø (cm) | h(cm) | ml | U.Venta |
|-------|-------|--------|-------|-----|---------|
| 66820 | 16,00 | 8 | 3 | 110 | 1 |



Semiésférica 24 cavidades

Hemispher 24 cavités · Halbkugelform 24 Madeleine
Half-spheres 24 moulds · Semi-esférica 24 cavidades

| Ref | € | Ø (cm) | h(cm) | ml | U.Venta |
|-------|-------|--------|-------|----|---------|
| 66800 | 16,00 | 3 | 1,7 | 10 | 1 |



Semiésférica 15 cavidades

Hemispher 15 cavités · Halbkugelform 15 Madeleine
Half-spheres 15 moulds · Semi-esférica 15 cavidades

| Ref | € | Ø (cm) | h(cm) | ml | U.Venta |
|-------|-------|--------|-------|----|---------|
| 66801 | 16,00 | 4 | 2 | 20 | 1 |



Semiésférica 6 cavidades

Hemispher 6 cavités · Halbkugelform 6 Madeleine
Half-spheres 6 moulds · Semi-esférica 6 cavidades

| Ref | € | Ø (cm) | h(cm) | ml | U.Venta |
|-------|-------|--------|-------|----|---------|
| 66802 | 16,00 | 7 | 3,5 | 80 | 1 |

Pirámide 6 cavidades

Pyramide 6 cavités · Pyramideform 6 Madeleine
Pyramid 6 moulds · Pirámide 6 cavidades

| Ref | € | cm | h(cm) | ml | U.Venta |
|-------|-------|-------|-------|----|---------|
| 66822 | 16,00 | 71x71 | 4 | 90 | 1 |



Muffin 6 cavidades

Muffin 6 cavités · Muffinform 6 Madeleine
Muffin 6 moulds · Muffin 6 cavidades

| Ref | € | Ø (cm) | h(cm) | ml | U.Venta |
|-------|-------|--------|-------|-----|---------|
| 66805 | 16,00 | 7 | 4 | 100 | 1 |



Mini muffin 11 cavidades

Mini muffin 11 cavités · Muffinform klein für 11 Madeleine
Mini muffin 11 moulds · Mini muffin 11 cavidades

| Ref | € | Ø (cm) | h(cm) | ml | U.Venta |
|-------|-------|--------|-------|----|---------|
| 66804 | 16,00 | 5 | 2,8 | 50 | 1 |



Corazón 8 cavidades

Coeur 8 cavités · Herzform 8 Madeleine
Heart 8 moulds · Coração 8 cavidades

| Ref | € | cm | h(cm) | ml | U.Venta |
|-------|-------|-------|-------|----|---------|
| 66824 | 16,00 | 6,5x6 | 3,5 | 90 | 1 |



Rectángulo pequeño 20 cavidades

Petit rectangle 20 cavités · Form rechteckig für 20 Madeleine
Petit-four 20 moulds · Rectángulo pequeno 20 cavidades

| Ref | € | cm | h(cm) | ml | U.Venta |
|-------|-------|-------|-------|----|---------|
| 66825 | 16,00 | 5x2,5 | 1,1 | 20 | 1 |



Cake 12 cavidades

Cake 12 cavités · Kuchenform 12 Madeleine
Cake 12 moulds · Cake 12 cavidades

| Ref | € | cm | h(cm) | ml | U.Venta |
|-------|-------|-----|-------|----|---------|
| 66826 | 16,00 | 8x3 | 3 | 70 | 1 |



Mini savarín 18 cavidades

Mini savarín 18 cavités · Savarinform 18 Madeleine
Mini savarín 18 moulds · Mini savarín 18 cavidades

| Ref | € | Ø (cm) | h(cm) | ml | U.Venta |
|-------|-------|--------|-------|----|---------|
| 66808 | 16,00 | 4 | 1,2 | 18 | 1 |



Molde flan 6 cavidades

Moule à flan 6 cavités · Madeleine Backform für 6 Madeleine
Creme caramel 6 moulds · Molde de flan 6 cavidades

| Ref | € | cm | h(cm) | L | U.Venta |
|-------|-------|-------|-------|------|---------|
| 66736 | 22,40 | 29x19 | 5 | 0,16 | 1 |



Molde cake

Moule à cake · Kuchenform
Cake mould · Molde cake

| Ref | € | cm | h(cm) | L | U.Venta |
|-------|-------|-------|-------|------|---------|
| 66733 | 22,20 | 24x10 | 6,5 | 1,50 | 1 |
| 66742 | 24,30 | 26x10 | 7,0 | 1,55 | 1 |



Molde savarín bajo

Moule Savarín bas · Savarinform, klein
Low Savarín mould · Molde pudín baixo

| Ref | € | Ø (cm) | h(cm) | L | U.Venta |
|-------|-------|--------|-------|------|---------|
| 66734 | 22,40 | 24 | 6 | 1,25 | 1 |



Molde savarín alto

Moule Savarín haut · Savarinform, gross
High Savarín mould · Molde pudín alto

| Ref | € | Ø (cm) | h(cm) | L | U.Venta |
|-------|-------|--------|-------|------|---------|
| 66735 | 24,40 | 22 | 11 | 2,20 | 1 |



Molde redondo

Moule à manqué · Tortenform
Round cake mould · Molde redondo

| Ref | € | Ø (cm) | h(cm) | L | U.Venta |
|-------|-------|--------|-------|------|---------|
| 66737 | 21,80 | 24 | 4,5 | 1,70 | 1 |
| 66738 | 22,40 | 26 | 4,5 | 2,20 | 1 |



Colección Platinum



Set de 2 moldes donuts

Ensemble de 2 moules à donuts · Set mit 2 Donut-Formen
Set of 2 doughnut moulds · Conjunto de 2 moldes para donuts

| Ref | € | Ø (cm) | h(cm) | L | U.Venta |
|-------|-------|--------|-------|------|---------|
| 68770 | 17,40 | 7,0 | 2 | 0,07 | 1 |

Molde donuts

Moules à donuts · Donut-Formen Zweier
Doughnut moulds · Molde para donuts

| Ref | € | Ø (cm) | h(cm) | L | U.Venta |
|-------|------|--------|-------|------|---------|
| 68760 | 8,70 | 7,0 | 2 | 0,07 | 1 |

Molde desmontable



Molde desmontable redondo

Moule demontable · Backform, zerlegbar
Dismountable mould · Molde desmontável

| Ref | € | Ø (cm) | h(cm) | L | U.Venta |
|---------|-------|--------|-------|-----|---------|
| 66775 | 23,10 | 25 | 7,5 | 2,0 | 1 |
| * 66778 | 18,00 | 20 | 7,5 | 1,6 | 1 |

* Apto para la freidora de aire (69511) · Suitable for air fryer (69511)

Molde desmontable rectangular

Moule demontable · Backform, zerlegbar
Dismountable mould · Molde desmontável

| Ref | € | cm | h(cm) | L | U.Venta |
|-------|-------|-------|-------|-----|---------|
| 66776 | 22,40 | 29x13 | 7,0 | 1,5 | 1 |

Molde desmontable cuadrado

Moule demontable · Backform, zerlegbar
Dismountable mould · Molde desmontável

| Ref | € | cm | h(cm) | L | U.Venta |
|-------|-------|-------|-------|-----|---------|
| 66777 | 26,10 | 25x25 | 7,5 | 2,5 | 1 |
| 66779 | 21,60 | 18x18 | 7,0 | 2,3 | 1 |

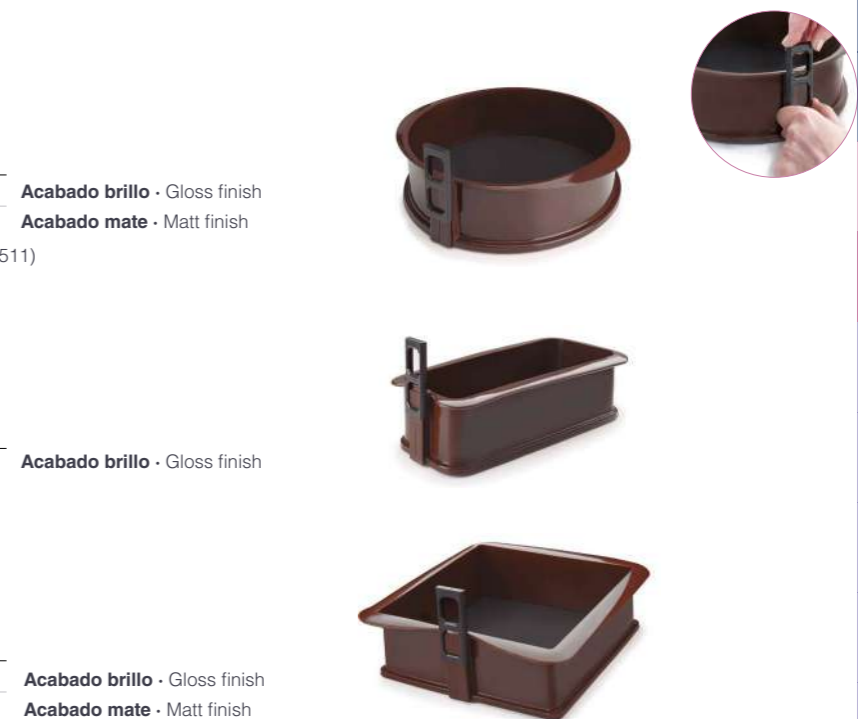

Moldes, tapetes y láminas



Apto para todas las freidoras de aire
Suitable for all air fryers



Set 12 moldes muffin silicóna

Set 12 moules muffin · Set 12 Muffin formen
12 muffin moulds set · Conj. 12 moldes muffin

| Ref | € | Ø (cm) | h(cm) | U.Venta |
|-------|------|--------|-------|---------|
| 66745 | 5,70 | 7 | 5 | 1 |



Flexible, antiadherente y reutilizable
Flexible, non-stick and reusable

30 macarons -> 5cm
48 macarons -> 4cm



Molde macarons doble

Moule macarons double · Doppel Macaronsform
Macarons dual mould · Molde macarons duplo

| Ref | € | cm | U.Venta |
|-------|-------|-------|---------|
| 66753 | 12,90 | 39x29 | 1 |

Flexible, antiadherente y reutilizable
Flexible, non-stick and reusable

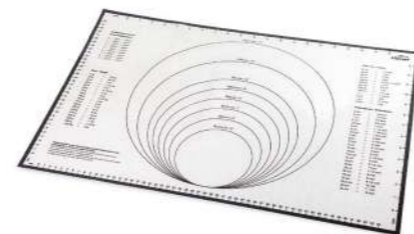

Tapete de silicóna impreso

Tapis en silicóna imprime · Bedruckte Silikonmatte
Printed silicon mat · Tapete de silicóna impreso

| Ref | € | cm | U.Venta |
|-------|-------|-------|---------|
| 66759 | 29,70 | 60x40 | 1 |

Flexible, antiadherente y reutilizable
Flexible, non-stick and reusable

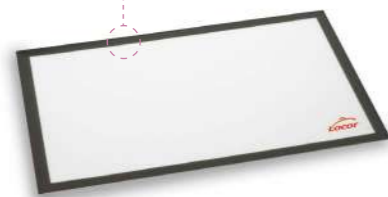

Tapete silicóna White

Tapis en silicóna · Backblech-Auflage Silikon
Silicone covering · Tapete de silicóna

| Ref | € | cm | U.Venta |
|-------|-------|-------|---------|
| 66749 | 20,80 | 30x40 | 1 |
| 66731 | 28,90 | 60x40 | 1 |
| 66732 | 21,40 | 52x32 | 1 |

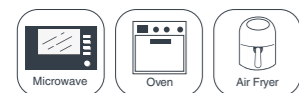

Fácil de cortar
Easy to cut



3 pcs

- Papel de horno para freidora de aire, horno, deshidratador y moldes repostería.
- Hoja de cocción fabricada en fibra de vidrio.
- Reutilizable, más de 1.000 hornados.
- 100% flexible, se adapta a todo tipo de cestillos, moldes, bandejas, etc.
- Antiadherente por ambos lados.
- Medidas: 30x40 cm. Soporta temperaturas hasta 250°C. Libre de PFOA.

- Friries à air, four, déshydrateur et papier de cuisson à cuisson.
- Fiche de cuisson fabriquée en fibre de verre.
- Réutilisable, plus de 1 000 cuits au four.
- 100% flexible, s'adapte à tous les types de paniers, moules, plateaux, etc.
- Uniabutor des deux côtés.
- Mesures: 30x40 cm. Prend en charge les températures jusqu'à 250 ° C. PFOA gratuit.

- Air frying, oven, dehydrator and baking baking paper.
- Cooking sheet manufactured in fiberglass.
- Reusable, more than 1,000 baked.
- 100% flexible, adapts to all types of baskets, molds, trays, etc.
- Uniabutor on both sides.
- Measures: 30x40 cm. Supports temperatures up to 250°C. PFOA free.

| Ref | € | cm | Unidad | U.Venta |
|-------|-------|-------|--------|---------|
| 66746 | 10,10 | 30x40 | 3 | 1 |

Parrillas, placas y pinzas



Varilla · Rod: Ø2 mm



Varilla · Rod: Ø5 mm

Parrilla Due

Grille · Gitter, Rost
Grate · Grelha

| Ref | € | cm | h(cm) | U.Venta |
|-------|-------|-------|-------|---------|
| 68741 | 30,60 | 60x40 | 0,8 | 1 |

Varilla · Rod: Ø3 mm

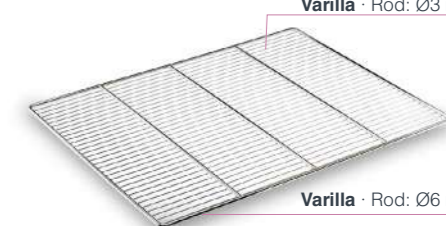

Varilla · Rod: Ø6 mm

Parrilla Tri

Grille · Gitter, Rost
Grate · Grelha

| Ref | € | cm | Medidas Cubeta | U.Venta |
|-------|-------|---------|----------------|---------|
| 66920 | 55,10 | 65x53 | 2/1 | 1 |
| 66921 | 21,20 | 53x32,5 | 1/1 | 1 |

AL
Aluminium



Placa horno antiadherente

Plaque à four aluminium anti-adhésif teflon · Backblech, Aluminium, Teflon
Teflon non-stick coated oven aluminium tray · Placa forno alumínio anti-aderente

| Ref | € | cm | h(cm) | U.Venta |
|-------|-------|--------|-------|---------|
| 68660 | 38,20 | 60x40 | 1,0 | 1 |
| 68659 | 34,70 | GN 1/1 | 1,0 | 1 |

FE
Iron



Placa horno Black

Plaque à four tôle noire · Backblech, Schwarzstahl
Baking sheet black steel · Placa de forno aço negro

| Ref | € | cm | h(cm) | U.Venta |
|-------|-------|-------|-------|---------|
| 68640 | 37,60 | 60x40 | 0,8 | 1 |

AL
Aluminium



Placa horno inox

Plaque à four · Backblech
Baking sheet · Placa de forno

| Ref | € | cm | h(cm) | U.Venta |
|-------|-------|--------|-------|---------|
| 68740 | 45,40 | 60x40 | 0,8 | 1 |
| 68739 | 35,10 | GN 1/1 | 0,8 | 1 |

Placa horno Aluminium

Plaque à four · Backblech
Baking sheet · Placa de forno

| Ref | € | cm | h(cm) | U.Venta |
|-------|-------|--------|-------|---------|
| 68641 | 35,60 | 60x40 | 0,8 | 1 |
| 68642 | 28,80 | GN 1/1 | 0,8 | 1 |

INOX 200°C
Max

Pinza para bandeja GN

Pince inox pour bac Gastronorm · Zange für GN Behälter
Tong GN tray · Pinça para forno e bandejas GN

| Ref | € | Largo (cm) | U.Venta | Con silicóna · With silicone |
|---------|-------|------------|---------|------------------------------|
| A 62989 | 17,50 | 20 | 12 | |
| B 62998 | 17,50 | 20 | 12 | |



Colección Inox

INOX 18/10 240°C Max
 Gas Microwave Oven Freezer Dishwasher



Cadena repostería

Chaîne pour pâtisserie · Kette für Konditorei
 String for pastry · Corrente para pastelería

| Ref | € | Largo (cm) | U.Venta |
|-------|-------|------------|---------|
| 68248 | 12,30 | 1,80 | 12 |



Molde 1/2 caña desmontable redondo

Gouttière à bûche · Terrinen-/Kuchenform "Dachrinne",
 Round cake mould · Molde 1/2 cana desmontável redondo

| Ref | € | cm | h(cm) | U.Venta |
|-------|-------|------|-------|---------|
| 68001 | 40,30 | 25x9 | 6,0 | 1 |
| 68002 | 50,40 | 50x9 | 6,0 | 1 |



Marco rectangular

Rectangle · Rahmen, rechteckig,
 Rectangular frame · Molde rectangular

| Ref | € | cm | h(cm) | U.Venta |
|-------|-------|-------|-------|---------|
| 68043 | 31,00 | 30x40 | 3,0 | 1 |
| 68041 | 31,20 | 30x40 | 5,0 | 1 |
| 68048 | 31,20 | 31x48 | 3,0 | 1 |
| 68049 | 32,60 | 31x48 | 5,0 | 1 |
| 68060 | 34,10 | 40x60 | 3,0 | 1 |
| 68061 | 35,30 | 40x60 | 5,0 | 1 |

Flanero

Moule à flan · Pudding-/Becherförmchen
 Pudding mould · Forma flan

| Ref | € | Ø (cm) | h(cm) | ml | U.Venta |
|-------|------|--------|-------|-----|---------|
| 60007 | 4,40 | 7 | 5,0 | 100 | 10 |
| 60008 | 5,30 | 8 | 5,3 | 200 | 10 |



Molde 1/2 caña desmontable triangular

Moule triangle "demie canne" · Terrinen-/Kuchenform "Dachrinne",
 Three-cornered cake mould · Molde 1/2 cana desmontável triangular

| Ref | € | cm | h(cm) | U.Venta |
|-------|-------|----------|-------|---------|
| 68003 | 39,20 | 25,5x9,4 | 9,4 | 1 |
| 68004 | 49,10 | 50,7x9,4 | 9,4 | 1 |



Bandeja

Plaque · Backblech
 Baking sheet · Bandeja

| Ref | € | cm | h(cm) | U.Venta |
|-------|-------|-------|-------|---------|
| 68030 | 40,10 | 30x40 | 1,0 | 1 |
| 68031 | 40,50 | 31x48 | 1,0 | 1 |
| 68040 | 71,50 | 40x60 | 1,0 | 1 |

Moldes aluminio

AL 250°C Max
 Aluminium Gas Microwave Oven Freezer Dishwasher ECO PFOA Free

- Amplia gama de moldes de aluminio con antiadherente para horno.
- Resistente a altas temperaturas, excelente conductor de calor.
- Recubrimiento antiadherente por toda la superficie de la pieza

- Large gamme de moules pour four en aluminium avec antiadhésif.
- Résistant à de hautes températures, excellent conducteur de chaleur.
- Revêtement antiadhésif sur toute la surface de la pièce.

- Wide range of non-stick aluminium moulds for the oven.
- Resistant to high temperatures, excellent heat conductor.
- The entire surface of the mould has a non-stick coating.



Set 4 flaneros

Jeu 4 Moule à flan · 4 Pudding-/Becherförmchen
 4 pcs. pudding mould · Conjunto 4 formas flan

| Ref | € | Ø (cm) | h(cm) | U.Venta |
|-------|-------|--------|-------|---------|
| 68808 | 14,80 | 8 | 5,2 | 6 |

Molde Cake

Moule à cake · Kuchenform, konisch
 Cake mould · Molde cake

| Ref | € | Largo (cm) | h(cm) | U.Venta |
|-------|-------|------------|-------|---------|
| 68825 | 12,50 | 25 | 7 | 6 |
| 68831 | 14,70 | 30 | 7 | 6 |
| 68835 | 15,80 | 35 | 7 | 6 |

Molde alto

Moule à manque · Käsekuchenform
 Pie mould · Molde alto

| Ref | € | Ø (cm) | h(cm) | U.Venta |
|-------|-------|--------|-------|---------|
| 68822 | 10,50 | 22 | 4,7 | 6 |
| 68827 | 11,40 | 26 | 5,0 | 6 |
| 68829 | 13,20 | 30 | 5,0 | 6 |
| 68833 | 14,40 | 32 | 5,2 | 6 |



Molde rizado

Moule à tarte fond fixe · Tortenbodenform, gewellter Rand.
 Tart mould · Molde frizado

| Ref | € | Ø (cm) | h(cm) | U.Venta |
|-------|-------|--------|-------|---------|
| 68723 | 11,20 | 24 | 3,7 | 6 |
| 68729 | 12,60 | 28 | 3,7 | 6 |
| 68732 | 13,40 | 32 | 3,7 | 6 |



Molde rizado movil

Moule à tarte fond mobile · Kuchenform, konisch
 Fruit tart mould · Molde frizado-fundo móvil

| Ref | € | Ø (cm) | h(cm) | U.Venta |
|-------|-------|--------|-------|---------|
| 68842 | 12,80 | 24 | 3 | 6 |
| 68882 | 17,00 | 28 | 3 | 6 |
| 68823 | 21,00 | 32 | 3 | 6 |



Flanero rizado

Moule à brioche · Briocheform
 Brioche mould · Molde flan frizado

| Ref | € | Ø (cm) | h(cm) | U.Venta |
|-------|-------|--------|-------|---------|
| 68810 | 5,70 | 10 | 4,0 | 6 |
| 68814 | 7,70 | 14 | 5,5 | 6 |
| 68818 | 8,60 | 18 | 6,5 | 6 |
| 68821 | 11,70 | 22 | 10 | 6 |

Molde savarin

Moule à Savarin · Reistrand/Savarinform
 Savarin mould · Molde pudim

| Ref | € | Ø (cm) | h(cm) | U.Venta |
|-------|-------|--------|-------|---------|
| 68724 | 17,60 | 24x6,5 | 5,7 | 6 |
| 68862 | 19,00 | 26x6,5 | 6,0 | 6 |
| 68863 | 19,30 | 28x6,5 | 6,0 | 6 |

Molde pizza

Moule à pizza · Pizzablech
 Pizza mould · Molde pizza

| Ref | € | Ø (cm) | h(cm) | U.Venta |
|-------|-------|--------|-------|---------|
| 68824 | 10,20 | 24 | 1,8 | 6 |
| 68828 | 10,90 | 28 | 1,8 | 6 |
| 68832 | 13,60 | 32 | 2,0 | 6 |
| 68836 | 15,30 | 36 | 2,0 | 6 |

Molde pizza perforado

Moule à pizza perforé · Pizzablech, gelocht
 Perforated Pizza mould · Molde pizza perforado

| Ref | € | Ø (cm) | h(cm) | U.Venta |
|-------|-------|--------|-------|---------|
| 67824 | 11,70 | 24 | 1,8 | 6 |
| 67828 | 12,40 | 28 | 1,8 | 6 |
| 67832 | 13,20 | 32 | 2,0 | 6 |
| 67836 | 14,00 | 36 | 2,0 | 6 |



Colección Delize



- Fabricado en acero al carbono.
- Antiadherente interior y exterior de máxima calidad, ecológico y libre de PFOA.
- La base desmontable y el clip lateral garantizan un mejor desmoldado y una mayor facilidad de uso.
- Resistente a altas temperaturas.
- Fondo rugoso para una distribución uniforme y retención del calor.
- Apto para el horno, nevera y congelador.

- Fabriqué en acier au carbone.
- Antiseurs intérieurs et extérieurs de la plus haute qualité, écologique et exempte de PFOA.
- La base amovible et le clip latéral garantissent une meilleure masse et une plus grande facilité d'utilisation.
- Températures élevées résistantes.
- Contexte robuste pour la distribution uniforme et la rétention de chaleur.
- Convient pour le four, le réfrigérateur et le congélateur.

- Manufactured in carbon steel.
- Interior and exterior antiating of the highest quality, ecological and free of PFOA.
- The removable base and the lateral clip guarantee a better unmolding and greater ease of use.
- High temperatures resistant.
- Rugged background for uniform distribution and heat retention.
- Suitable for the oven, fridge and freezer.



Molde desmontable

Moule demontable · Kuchenform
Dismountable mould · Molde desmontável

| Ref | € | Ø (cm) | h(cm) | L | U.Venta |
|-------|-------|--------|-------|------|---------|
| 68676 | 7,90 | 18 | 6,8 | 1,50 | 1 |
| 68680 | 8,30 | 20 | 6,8 | 1,90 | 1 |
| 68684 | 9,60 | 24 | 6,8 | 2,80 | 1 |
| 68686 | 10,20 | 26 | 6,8 | 3,30 | 1 |
| 68688 | 11,20 | 28 | 6,8 | 3,80 | 1 |
| 68696 | 12,00 | 16 | 13 | 2,00 | 1 |

Molde baguette

Moule à baguette · Baguette-Form
Baguette mould · Molde para baguetes

| Ref | € | cm | h(cm) | Compartimentos | U.Venta |
|-------|-------|---------|-------|----------------|---------|
| 68450 | 11,40 | 38x31,5 | 2,6 | 4 | 1 |

Molde cake

Moule à cake · Kuchenform, konisch
Cake mould · Molde cake

| Ref | € | cm | h(cm) | L | U.Venta |
|-------|------|-----------|-------|------|---------|
| 68451 | 6,30 | 25x11,5 | 7,0 | 1,60 | 1 |
| 68452 | 7,30 | 31x11,5 | 7,0 | 1,90 | 1 |
| 68453 | 8,80 | 35,6x11,5 | 7,0 | 2,25 | 1 |



Molde alto

Moule à manque · Käsekuchenform
Pie mould · Molde alto

| Ref | € | Ø (cm) | h(cm) | L | U.Venta |
|-------|------|--------|-------|------|---------|
| 68455 | 6,10 | 24 | 4,5 | 1,50 | 1 |
| 68456 | 7,90 | 28 | 4,5 | 2,00 | 1 |



Molde savarin

Moule à Savarin · Reisrand/Savarinform
Savarin mould · Molde pudim

| Ref | € | Ø (cm) | h(cm) | L | U.Venta |
|-------|-------|--------|-------|------|---------|
| 68454 | 11,20 | 26 | 8,6 | 2,15 | 1 |



Molde rizado

Moule à tarte fond fixe · Tortenbodenform, gewellter Rand.
Tart mould · Molde frizado

| Ref | € | Ø (cm) | h(cm) | L | U.Venta |
|-------|-------|--------|-------|------|---------|
| 68790 | 4,50 | 14 | 2,5 | 0,30 | 1 |
| 68791 | 6,60 | 20 | 2,5 | 0,60 | 1 |
| 68792 | 8,50 | 24 | 2,8 | 1,00 | 1 |
| 68793 | 9,10 | 26 | 2,8 | 1,20 | 1 |
| 68794 | 9,70 | 28 | 3,0 | 1,45 | 1 |
| 68795 | 10,70 | 30 | 3,0 | 1,50 | 1 |
| 68796 | 11,50 | 32 | 3,0 | 1,70 | 1 |
| 68780 | 4,80 | 14 | 2,5 | - | 1 |
| 68781 | 6,90 | 20 | 2,5 | - | 1 |
| 68782 | 8,80 | 24 | 3,0 | - | 1 |
| 68783 | 9,60 | 26 | 3,0 | - | 1 |
| 68784 | 10,50 | 28 | 3,0 | - | 1 |
| 68785 | 11,20 | 30 | 3,0 | - | 1 |
| 68786 | 12,10 | 32 | 3,0 | - | 1 |



Molde rizado alto

Moule à tarte fond fixe · Tortenbodenform, gewellter Rand.
Tart mould · Molde frizado

| Ref | € | Ø (cm) | h(cm) | L | U.Venta |
|-------|-------|--------|-------|------|---------|
| 68797 | 9,70 | 20 | 5,0 | 1,25 | 1 |
| 68798 | 10,30 | 24 | 5,0 | 1,90 | 1 |
| 68799 | 12,80 | 28 | 5,0 | 2,80 | 1 |
| 68787 | 10,10 | 20 | 5,0 | - | 1 |
| 68788 | 11,00 | 24 | 5,0 | - | 1 |
| 68789 | 13,20 | 28 | 5,0 | - | 1 |



COMPOSICIÓN:

- Bandeja: 38,2x26x1,5 cm
- Molde muffin: 33,5x20,5x3 cm (0,98 L)
- Molde cuadrado: 24x22x5,5 cm (2,01 L)
- Molde cake: 24x12x5,5 cm (0,90 L)
- Rustidera: 38,2x26x5 cm (3,40 L)

Set 5 moldes

Ensemble de 5 moules · Satz mit 5 Förmchen
Set of 5 moulds · Conjunto de 5 moldes

| Ref | € | Piezas | U.Venta |
|-------|-------|--------|---------|
| 68461 | 40,00 | 5 | 1 |



Molde pizza

Moule à pizza · Pizzablech
Pizza mould · Molde pizza

| Ref | € | Ø (cm) | h(cm) | U.Venta |
|-------|------|--------|-------|---------|
| 68472 | 5,40 | 29,5 | 1,5 | 1 |
| 68473 | 6,30 | 34,0 | 2,0 | 1 |
| 68470 | 6,70 | 33,5 | 1,0 | 1 |
| 68471 | 8,60 | 36,0 | 1,0 | 1 |

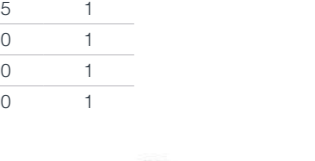

Bandeja

Plateaux · Tablett
Tray · Bandeja

| Ref | € | cm | h(cm) | U.Venta |
|-------|-------|---------|-------|---------|
| 68462 | 13,20 | 34x24 | 2,5 | 1 |
| 68463 | 14,30 | 39x26,5 | 3,0 | 1 |
| 68464 | 16,40 | 44x29 | 3,0 | 1 |



Colección Noir



- Fabricado en acero al carbono.
- Revestimiento antiadherente de gran calidad sin PFOA en el interior y el exterior.
- Distribuye el calor de manera uniforme.
- Apto para hornos hasta 240°C.
- No se recomienda lavarlo en el lavavajillas.

- Fabriqué en acier au carbone.
- Revêtement anticartier de haute qualité sans PFOA à l'intérieur et à l'extérieur.
- Distribuez la chaleur uniformément.
- Apte pour les fours jusqu'à 240 ° C.
- Il n'est pas recommandé de le laver au lave-vaisselle.

- Manufactured in carbon steel.
- High quality antiating coating without PFOA inside and outside.
- Distribute heat evenly.
- Apt for furnaces up to 240 ° C.
- It is not recommended to wash it in the dishwasher.



Molde 12 cavidades madalenas

Plaque madeleine 12 alveoles · Muffinform 12 Madeleine
12 cups madelaine pan · Molde cavidades 12 madalenas

| Ref | € | cm | h(cm) | U.Venta |
|-------|-------|-----------|-------|---------|
| 68000 | 15,70 | 39,8x19,5 | 2,0 | 1 |



Molde 12 cavidades

Plaque à biscuits 12 alveoles · Madeleine-Backform für 12 Madeleine
12 cups muffin pan · Molde 12 cavidades

| Ref | € | cm | h(cm) | U.Venta |
|-------|-------|---------|-------|---------|
| 68010 | 18,60 | 35x26,5 | 3,0 | 1 |



Molde cake chapa antiadherente

Moule à cake tôle anti-adh. · Back/Pastetenform, Antihaf
Cake mould rolled. · Molde cake chapa adherente

| Ref | € | cm | h(cm) | U.Venta |
|-------|-------|-------|-------|---------|
| 68725 | 9,00 | 25x12 | 8,5 | 6 |
| 68730 | 9,20 | 30x12 | 8,5 | 6 |
| 68735 | 10,20 | 35x12 | 8,5 | 6 |



Molde desmontable redondo

Moule rond desmontable · Tortenbodenform
Dismountable round mould · M. desmontável redondo

| Ref | € | Ø (cm) | h(cm) | U.Venta |
|-------|-------|--------|-------|---------|
| 68714 | 11,10 | 24 | 7 | 1 |
| 68716 | 11,60 | 26 | 7 | 1 |
| 68718 | 11,70 | 28 | 7 | 1 |



Juego 4 cornetes

Ensemble de 4 moule cornet · Hornförmchen 4-tlg
4 pcs. non stick cream horn set · Jogo 4 forma de cornucópia

| Ref | € | cm | U.Venta |
|-------|------|----|---------|
| 68936 | 6,90 | 12 | 6 |

Moldes Bombón



- Molde profesional para elaborar deliciosos y originales bombones.
- Fabricado en poliestireno de alta calidad.
- Obtén bombones perfectos y con un brillo único.
- Cómodo de utilizar: rellena el molde con chocolate fundido, retira el exceso de chocolate deja reposar, vuelca el molde y da un pequeño golpe para que salgan los bombones.
- Fácil de limpiar y resistente al uso diario.
- Superficie lisa para un mejor desplazamiento de la espátula a la hora de retirar el chocolate sobrante.

- Moule professionnel pour faire des chocolats délicieux et originaux.
- Fabriqué en polystyrène de haute qualité.
- Obtenez des chocolats parfaits et avec un éclat unique.
- Confortable à utiliser: Remplissez le moule de chocolat fondu, retirez l'excès de chocolat, laissez reposer, tournez le moule et prenez un petit coup pour que les chocolats sortent.
- Facile à nettoyer et résistant à l'utilisation quotidienne.
- Surface lisse pour un meilleur déplacement de spatule lors de l'élimination des restes de chocolat.

- Professional mold to make delicious and original chocolates.
- Made of high quality polystyrene.
- Get perfect chocolates and with a unique shine.
- Comfortable to use: Fill the mold with molten chocolate, remove excess chocolate, let stand, turn the mold and take a small blow for the chocolates to come out.
- Easy to clean and resistant to daily use.
- Smooth surface for a better spatula displacement when removing leftover chocolate.

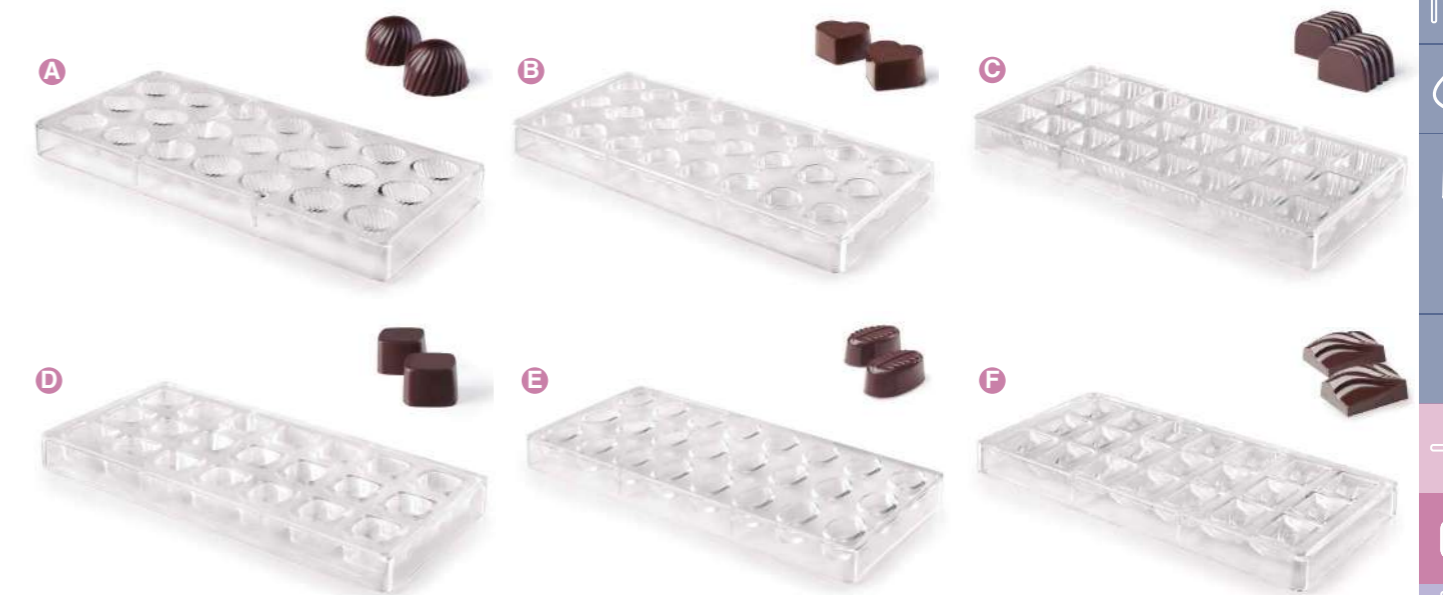
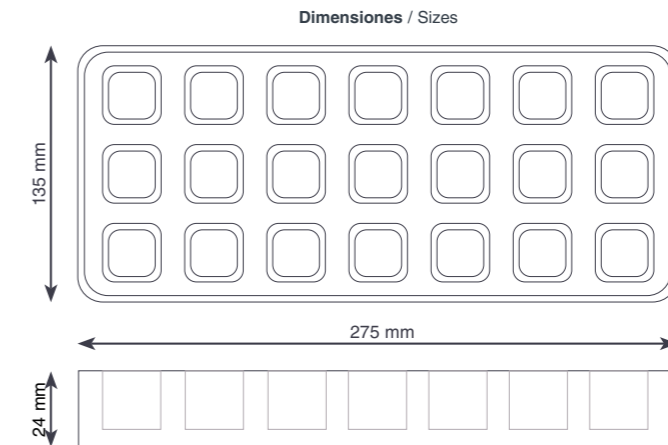

Molde bombón

Moule pour chocolats · Pralinengießform
Chocolate mould · Molde para bombons

| | Ref | € | cm | h(cm) | Capacidad | U.Venta | |
|---|-------|-------|---------|-------|-----------|---------|----------------------------|
| A | 66870 | 17,90 | Ø2,8 | 19,0 | 7 ml | 1 | Semiesférica · Half-sphere |
| B | 66871 | 17,90 | 2,5x2,0 | 11,5 | 6 ml | 1 | Corazón · Heart |
| C | 66872 | 17,90 | 2,5x2,5 | 17,0 | 10 ml | 1 | Lineal · Linear |
| D | 66874 | 17,90 | 2,5x2,5 | 17,0 | 10 ml | 1 | Cuadrado · Square |
| E | 66875 | 17,90 | 3,5x1,9 | 12,0 | 7 ml | 1 | Hoja · Leaf |
| F | 66877 | 17,90 | 3,2x2,5 | 12,5 | 7 ml | 1 | Ondulado · Ondulated |



Aros repostería

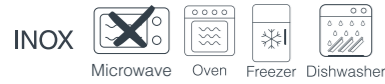

- **Fabricado en acero inoxidable 18/10.**
- **Ideal para brisa, hojaldre y choux.**
- **Consigue bordes regulares, bien denidos y con una extracción perfecta de la base. Acabado excepcional.**
- **Disponible en distintas formas y tamaños.**

- **Fabriqué en acier inoxydable 18/10.**
- **Idéal pour la brise, la pâte feuilletée et le choux.**
- **Obtenez des bords réguliers, bien appelés et avec une extraction parfaite de la base. Finition exceptionnelle.**
- **Disponible en différentes formes et tailles.**

- **Made of stainless steel 18/10.**
- **Ideal for breeze, puff pastry and choux.**
- **Get regular edges, well called and with a perfect extraction of the base. Exceptional finish.**
- **Available in different shapes and sizes.**



Aro redondo
Cercle rond · Kuchen-/Ausstechformen, rund
Round cake ring · Aro redondo



Aro redondo Mouse
Cercle rond · Kuchen-/Ausstechformen, rund
Round cake ring · Aro redondo



Aro redondo Vacherin
Cercle rond · Kuchen-/Ausstechformen, rund
Round cake ring · Aro redondo

| Ref | € | Ø (cm) | h(cm) | U.Venta |
|-------|-------|--------|-------|---------|
| 68406 | 3,10 | 6 | 4 | 12 |
| 68407 | 3,20 | 7,5 | 4 | 12 |
| 68408 | 3,30 | 8 | 4 | 12 |
| 68410 | 3,40 | 10 | 4 | 12 |
| 68412 | 5,30 | 12 | 4 | 12 |
| 68414 | 5,00 | 14 | 4 | 6 |
| 68416 | 6,90 | 16 | 4 | 6 |
| 68418 | 8,20 | 18 | 4 | 6 |
| 68420 | 10,00 | 20 | 4 | 1 |
| 68422 | 10,10 | 22 | 4 | 1 |
| 68424 | 11,40 | 24 | 4 | 1 |



Aro redondo Entremet
Cercle rond · Kuchen-/Ausstechformen, rund
Round cake ring · Aro redondo

| Ref | € | Ø (cm) | h(cm) | U.Venta |
|-------|------|--------|-------|---------|
| 68308 | 3,20 | 8 | 3,5 | 12 |
| 68310 | 3,20 | 10 | 3,5 | 12 |

INOX 18/10

Molde cuadrado
Carre pour patisserie · Kuchen-/Ausstech formen, vierecking
Square pastry mould · Molde cuadrado

| Ref | € | cm | h(cm) | U.Venta |
|-------|------|-------|-------|---------|
| 68460 | 4,80 | 6x6 | 4 | 12 |
| 68480 | 4,90 | 8x8 | 4 | 12 |
| 68411 | 5,00 | 10x10 | 4 | 12 |
| 68441 | 5,30 | 14x14 | 4 | 6 |
| 68240 | 6,80 | 20x20 | 4 | 6 |



Juego aros repostería
Ensemble de cercles à pâtisserie · Ausstechformen, Set
Pastry rings set · Jogo aros de pasteleria

| Ref | € | cm | h(cm) | Forma | U.Venta |
|-------|-------|------|-------|-----------------|---------|
| 68203 | 11,10 | Ø7,7 | null | Redondo · Round | 1 |



INOX 18/10

Aro tarta borde vuelto
Cercle "goutte" · Tortenring
Tart ring · Aro torta

| Ref | € | Ø (cm) | h(cm) | U.Venta |
|-------|------|--------|-------|---------|
| 68107 | 3,70 | 8 | 2,2 | 6 |
| 68121 | 3,90 | 10 | 2,2 | 6 |
| 68120 | 7,80 | 20 | 2,2 | 1 |



INOX 18/10

Aro repostería extensible
Cercle extensible · Kuchenform, verstellbar
Adjustable pastry ring · Aro extensivel pasteleria

| Ref | € | Ø (cm) | h(cm) | U.Venta |
|-------|-------|--------|-------|---------|
| 68200 | 18,20 | 16-30 | 7,0 | 1 |



INOX 18/10

Aro cuadrado perforado
Cercle carre perforee · Kuchen-/Ausstechformen, gelocht
Perforated square cake ring · Aro cuadrado perforada

| Ref | € | cm | h(cm) | U.Venta |
|-------|-------|-------|-------|---------|
| 68557 | 3,80 | 7x7 | 2,0 | 6 |
| 68556 | 6,30 | 16x16 | 2,0 | 6 |
| 68560 | 7,80 | 20x20 | 2,0 | 6 |
| 68567 | 5,10 | 7x7 | 3,5 | 6 |
| 68566 | 9,90 | 16x16 | 3,5 | 6 |
| 68570 | 12,00 | 20x20 | 3,5 | 6 |



INOX 18/10

Aro rectangular perforado
Cercle rectangulaire perforee · Kuchen-/Ausstechformen, gelocht
Perf. rectangular cake ring · Aro rectangular perf.

| Ref | € | cm | h(cm) | U.Venta |
|-------|-------|------|-------|---------|
| 68590 | 5,30 | 7x20 | 2,0 | 6 |
| 68591 | 8,10 | 7x20 | 3,5 | 6 |
| 68597 | 10,70 | 8x28 | 3,5 | 6 |
| 68598 | 6,60 | 8x28 | 2,0 | 6 |



INOX 18/10

Aro redondo perforado
Cercle rond perforee · Kuchen-/Ausstechformen, rund, gelocht
Perforated round cake ring · Aro redondo perforada

| Ref | € | Ø (cm) | h(cm) | U.Venta |
|-------|-------|--------|-------|---------|
| 68537 | 3,20 | 7 | 2,0 | 6 |
| 68532 | 4,00 | 12 | 2,0 | 6 |
| 68536 | 5,10 | 16 | 2,0 | 6 |
| 68538 | 5,60 | 18 | 2,0 | 6 |
| 68540 | 6,50 | 20 | 2,0 | 6 |
| 68544 | 7,80 | 24 | 2,0 | 6 |
| 68558 | 8,70 | 28 | 2,0 | 6 |
| 68547 | 4,40 | 7 | 3,5 | 6 |
| 68552 | 6,50 | 12 | 3,5 | 6 |
| 68546 | 7,90 | 16 | 3,5 | 6 |
| 68548 | 8,80 | 18 | 3,5 | 6 |
| 68550 | 9,90 | 20 | 3,5 | 6 |
| 68554 | 11,80 | 24 | 3,5 | 6 |
| 68568 | 13,90 | 28 | 3,5 | 6 |

INOX 18/10

Aro oval perforado
Cercle oval perforee · Kuchen-/Ausstechformen, oval, gelocht
Perforated oval cake ring · Aro oval perforada

| Ref | € | cm | h(cm) | U.Venta |
|-------|-------|------|-------|---------|
| 68580 | 5,10 | 7x20 | 2,0 | 6 |
| 68581 | 7,40 | 7x20 | 3,5 | 6 |
| 68588 | 6,50 | 8x28 | 2,0 | 6 |
| 68587 | 10,20 | 8x28 | 3,5 | 6 |



INOX 18/10

Aro corazón perforado
Cercle coeur perforee · Kuchen-/Ausstechformen, gelocht
Perforated heart ring · Aro coração perforada

| Ref | € | Ø (cm) | h(cm) | U.Venta |
|-------|------|--------|-------|---------|
| 68482 | 4,60 | 12 | 2,0 | 6 |
| 68488 | 3,10 | 8 | 2,0 | 6 |



INOX 18/10

INOX 18/10

Aro hoja perforado
Cercle feullere perforee · Kuchen-/Ausstechformen, gelocht
Perforated Eal ring · Aro folha perforada

| Ref | € | cm | h(cm) | U.Venta |
|-------|------|--------|-------|---------|
| 68492 | 3,50 | 12x5 | 2,0 | 6 |
| 68498 | 4,50 | 18x7,8 | 2,0 | 6 |

05

Restauración
Restauration





Pizarras Menú

Personalizable en tiza o rotuladores fluorescentes (Ref.: 39161).
Fácil de limpiar.
Can be personalised with chalk or fluorescent markers (Ref.: 39161).
Easy to clean.



RUBBER
WOOD

- Diseño tradicional. Ofrece un espacio para que los establecimientos de hostelería expongan en sus locales como en la calle sus productos y menús.
- Puede ser personalizada tanto con tizas como con rotuladores.
- Limpieza muy sencilla con un simple trapo húmedo.

- Conception traditionnelle. Il offre un espace pour les établissements hôteliers pour exposer leurs produits et menus dans la rue.
- Il peut être personnalisé avec la craie et les marqueurs.
- Nettoyage très simple avec un simple chiffon humide.

- Traditional design. It offers a space for hospitality establishments to exhibit their products and menus in the street.
- It can be customized with both chalk and markers.
- Very simple cleaning with a simple wet cloth.

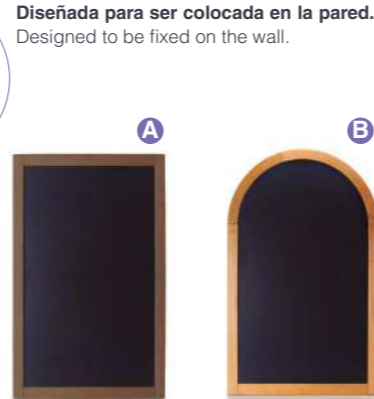
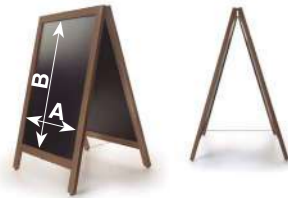

Diseñada para ser colocada en la pared.
Designed to be fixed on the wall.

Pizarra menú Doble

Menu ardoise · Schreibrtafel Menu
Menu blackboard · Quadro de menu

| Ref | € | cm | AxB (cm) | U.Venta |
|-------|--------|--------|----------|---------|
| 39166 | 94,80 | 55x85 | 47x67 | 1 |
| 39164 | 137,70 | 65x115 | 55x90 | 1 |

Pizarra menú

Menu ardoise · Schreibrtafel Menu
Menu blackboard · Quadro de menu

| Ref | € | cm | AxB (cm) | U.Venta |
|---------|-------|-------|----------|---------|
| A 39162 | 52,30 | 50x80 | 43x73 | 1 |
| B 39163 | 57,20 | 50x80 | 43x73 | 1 |

- Para usar con la pizarra eléctrica led (ref. 39140-60).
- No son tóxicos. Fáciles de limpiar.

- To use with the LED electric board (Ref. 39140-60).
- They are not toxic. Easy to clean.



8
Colores
Colours

Rotuladores fluorescentes

Marqueurs fluorescents · Fluoreszierenden marker
Fluorescent markers · Maracadores fluirescentes

| Ref | € | cm | U.Venta |
|-------|-------|----|---------|
| 39161 | 34,10 | 10 | 1 |

Pizarra eléctrica Led

Tableau lumineux à LED · LED Tafel
Blackboard LED · Ardósia LED

| Ref | € | W | Funciones | Medidas | U.Venta |
|---------|--------|---|-----------|----------|---------|
| A 39140 | 105,50 | 2 | 38 | 40x60 cm | 1 |
| B 39160 | 144,80 | 2 | 38 | 60x80 cm | 1 |

Porta menú Acrílico - Aluminio



ASA
Acrylic

Porta Menú Acrílico

Porte-menu · Menü-Ständer
Menu holder · Porta-menus

| Ref | € | cm | U.Venta |
|---------|-------|------------|---------|
| A 39403 | 74,40 | 50x38 (A3) | 1 |
| B 39404 | 57,20 | 29x38 (A4) | 1 |

Pared: gracias a los accesorios incluidos para anclar en la pared
Sobremesa: gracias a los pies de apoyo incluidos
Intercambiable de forma fácil, rápida y cómoda
Wall: thanks to the included accessories to anchor on the wall
Table: thanks to the support feet included
An easy, quick and convenient exchangeable



ASA AL
Acrylic Aluminium

Atril + portamenú acrílico

Pupitre porte-menu · Menü-Ständer
Menu holder lectern · Atril porta-menus

| Ref | € | cm | Tamaño | U.Venta |
|---------|--------|-----------|--------|---------|
| A 39402 | 148,90 | 34x30x103 | - | 1 |
| B 39423 | 223,20 | 34x30x107 | A3 | 1 |
| C 39424 | 206,00 | 34x30x107 | A4 | 1 |

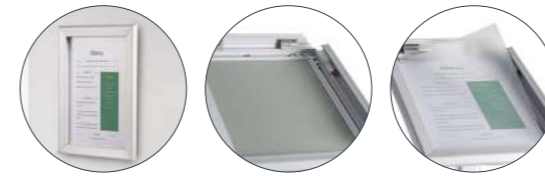

AL
Aluminium

Portamenú Aluminio

Porte-menu · Menü-Ständer
Menu holder · Porta-menus

| Ref | € | cm | U.Venta |
|---------|-------|--------------|---------|
| A 39413 | 40,20 | 46x34 (A3) | 1 |
| B 39414 | 28,70 | 25,5x34 (A4) | 1 |

Pared: gracias a los accesorios incluidos para anclar en la pared
Lámina de polipropileno para evitar el degradado de la hoja de información.
Intercambiable de forma fácil, rápida y cómoda
Wall: thanks to the included accessories to anchor on the wall
Polypropylene sheet to prevent the degradation in information sheet. One-click opening frame
An easy, quick and convenient exchangeable

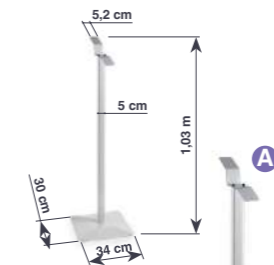

AL
Aluminium

Atril + Porta menú aluminio

Pupitre porte-menu · Menü-Ständer
Menu holder lectern · Atril porta-menus

| Ref | € | cm | Tamaño | U.Venta |
|---------|--------|-----------|--------|---------|
| A 39402 | 148,90 | 34x30x103 | - | 1 |
| B 39433 | 188,90 | 34x30x107 | A3 | 1 |
| C 39434 | 177,40 | 34x30x107 | A4 | 1 |

Porta menú sobremesa

- Ideales para resaltar todo tipo de información (menú, especialidades del día, promociones, etc.).
- Desmontables para escribir fácilmente.
- Fácil limpieza.

- Idéales pour faire ressortir tout type d'information (Menu, spécialités du jour, promotions, etc.).
- Démontables pour écrire confortablement.
- Nettoyage facile.

- Perfect for displaying all kinds of information (Fixed price menu, daily specials, promotions, etc.).
- Can be taken apart for easier writing.
- Easy to clean.

Fijación mediante imán
Magnetic fixing

Visualización a doble cara
Double-sided display

ASA
Acrylic

Base desmontable
Removable base



Apta para rotuladores fluorescentes (Ref.: 39161)
Can be used with fluorescent markers (Ref.: 39161)

Soporte de madera de pino con acabado caoba
Walnut coloured Pinewood support



Porta menú Acrylic

Porte-menu de table · Desktop-Menu
Menu cover · Porta menu de mesa

| Ref | € | cm | U.Venta |
|-------|-------|-------|---------|
| 39405 | 10,60 | 11x17 | 1 |
| 39406 | 11,60 | 13x19 | 1 |
| 39407 | 25,10 | 21x30 | 1 |

Porta menú Pizarra

Porte-menu de table · Desktop-Menu
Menu cover · Porta menu de mesa

| Ref | € | cm | U.Venta |
|-------|-------|-------|---------|
| 39415 | 15,50 | 10x15 | 1 |
| 39420 | 18,40 | 15x20 | 1 |
| 39430 | 22,70 | 20x30 | 1 |

Soporte de madera de pino con acabado caoba
Walnut coloured Pinewood support

Porta menú pinza

Porte-menu de table · Desktop-Menu
Menu cover · Porta menu de mesa

| Ref | € | cm | U.Venta |
|-------|-------|-------|---------|
| 39410 | 23,30 | 18x23 | 1 |
| 39411 | 7,20 | - | 1 |



Pinza · Clamp

Porta menú

Materiales certificados · Matériaux certifiés · Authorised materials

Cuero reciclado · Recycled leather

- Fabricado en cuero 100% reciclado (80% de cuero y un 20% de caucho natural). Espesor de 1,6 mm.
- Certificado OEKO-TEX®.
- Producidos artesanalmente en España.
- Máxima calidad; duraderos y resistentes.
- Fácil de limpiar (no utilizar jabones abrasivos).

- Fabriqué en cuir recyclé à 100 % (80 % de cuir et 20 % de caoutchouc naturel). Épaisseur de 1,6 mm.
- Certifié OEKO-TEX®.
- Fabriqué à la main en Espagne.
- Qualité maximale ; durable et résistant.
- Facile à nettoyer (ne pas utiliser de savons abrasifs).

- Made of 100% recycled leather (80% leather and 20% natural rubber). Thickness of 1.6 mm.
- OEKO-TEX® certified.
- Handcrafted in Spain.
- Maximum quality; durable and resistant.
- Easy to clean (do not use abrasive soaps).

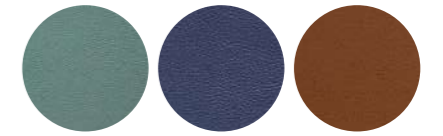

Fibra de celulosa · Cellulose fibre

- Fabricado en 100% fibra de celulosa. Material 100% vegano. Certificado OEKO-TEX®.
- Producidos artesanalmente en España.
- Tacto similar al cuero, blando y flexible. Diseño elegante y sostenible.
- Lavable con agua tibia y jabón neutro (no utilizar jabones abrasivos).

- Fabriqué en fibre de cellulose à 100 %. Matériau 100 % végétalien. Certifié OEKO-TEX®.
- Fabriqué à la main en Espagne.
- Sensation de cuir, souple et flexible. Design élégant et durable.
- Lavable à l'eau chaude et au savon neutre (ne pas utiliser de savon abrasif).

- Made of 100% cellulose fibre. 100% vegan material. OEKO-TEX® certified.
- Handmade in Spain.
- Leather-like feel, soft and flexible. Elegant and sustainable design.
- Washable with warm water and neutral soap (do not use abrasive soaps).

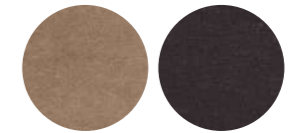

Teflex

- Fabricado por un soporte celulósico recubierto con una capa vinílica de alta resistencia.
- Producidos artesanalmente en España.
- Acabado imitación tela. Gran flexibilidad y durabilidad.
- Resistencia a la abrasión, manchado y rayado. Fácil de limpiar (no utilizar jabones abrasivos).

- Fabriqué à partir d'un support en cellulose recouvert d'un revêtement en vinyle très résistant.
- Fabriqué à la main en Espagne.
- Finition imitation tissu. Grande flexibilité et durabilité.
- Résistant à l'abrasion, aux taches et aux rayures. Facile à nettoyer (ne pas utiliser de savons abrasifs).

- Made of a cellulose backing covered with a highly resistant vinyl coating.
- Handmade in Spain.
- Imitation fabric finish. High flexibility and durability.
- Resistant to abrasion, stains and scratches. Easy to clean (do not use abrasive soaps).

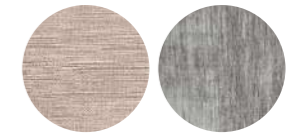
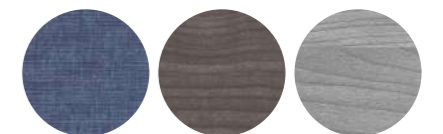

Simil-Piel

- Fabricado en poliuretano de gran calidad.
- Producidos artesanalmente en España.
- Base de tejido suave y ligeramente extensible. Aspecto de piel y tacto único.
- Material termo-irradiado; permite conseguir un atractivo efecto de estampado.
- Fácil de limpiar (no utilizar jabones abrasivos).

- Fabriqué en polyuréthane de haute qualité.
- Fabriqué à la main en Espagne. Base en tissu souple et légèrement extensible.
- Aspect et toucher cuir uniques.
- Matériau thermo-virable ; permet d'obtenir un effet de motif attrayant.
- Facile à nettoyer (ne pas utiliser de savons abrasifs).

- Made of high quality polyurethane.
- Handmade in Spain.
- Soft and slightly stretchable fabric base. Unique leather look and feel.
- Thermo-irradiable material; allows for an attractive patterned effect.
- Easy to clean (do not use abrasive soaps).

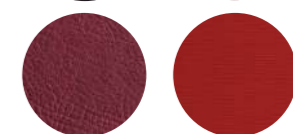



Fundas fijas

Protège-feuilles · Fixed flaps

Fundas fijas de PVC en piel de naranja. Altamente resistentes.
Protège-feuilles fixes en PVC en peau d'orange. Hautement résistantes.
Highly resistant, fixed frosted PVC covers.

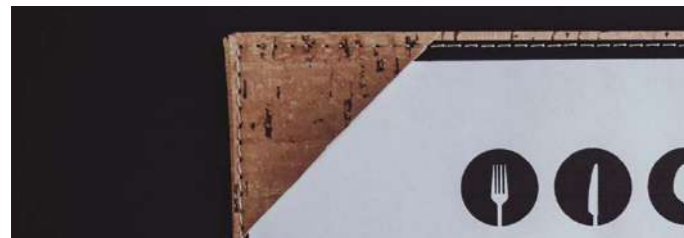

Solapas fijas

Rabats fixes · Fixed flaps

Solapas fijas a la cubierta
Rabats fixes sur la couverture
Flaps fixed to the cover

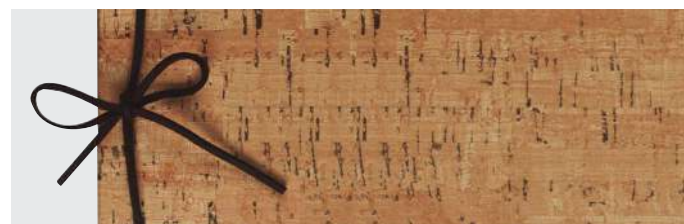

Cordón de cuero

Cordon en cuir · Leather cord

Permite añadir o cambiar fundas.
Permet d'ajouter ou de modifier des pochettes.
New covers can be added.



Goma

Élastique · Elastic band

Permite añadir o cambiar fundas.
Permet d'ajouter ou de modifier des pochettes.
New covers can be added.



Atornillado interior

Vissage intérieur · Interior screwed

Permite añadir o cambiar fundas.
Permet d'ajouter ou de modifier des pochettes.
New covers can be added.



Atornillado exterior

Vissage extérieur · Exterior screwed

Permite añadir o cambiar fundas.
Permet d'ajouter ou de modifier des pochettes.
New covers can be added.

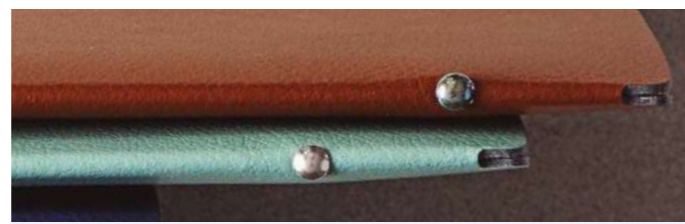

Remache lateral

Rivet latérale · Remache lateral

Permite añadir o cambiar fundas.
Permet d'ajouter ou de modifier des pochettes.
New covers can be added.



Pinza

Pince · Clip

Pinza metálica de color plata que sujeta la hoja del menú
Doté d'une pince métallique couleur argent
qui tient la feuille de menu
Silver-coloured metal clip that holds the menu in place

PVC
Plastic

Set 10 fundas interiores PVC

Jeu 10 feuilles intérieures PVC Peau d'orange · 10 Tlg. Innere Blätter, PVC, Orangenhaut
Set 10 interior frosted PVC pages · Set 10 lâminas interiores de PVC pele de Laranja

| Ref | € | cm | U.Venta | Compatible con · Compatible with |
|-------|-------|--------------|---------|---|
| 28191 | 12,00 | 21x29,7 (A4) | 10 | Ref.: 28261, 28500, 28510, 28520, 28530 |
| 28192 | 9,30 | 14x26 | 10 | Ref.: 28511, 28531, 28521, 28501, 28212, 28262 |
| 28190 | 8,30 | 16x29,7 | 10 | Ref.: 28342, 28352, 28372 |
| 28193 | 9,40 | 14,8x21 (A5) | 10 | Ref.: 28512, 28343, 28532, 28353, 28522, 28373, 28502, 28213, 28263 |
| 28194 | 12,00 | 21x29,7 (A4) | 10 | Ref.: 28550, 28540, 28371, 28351 |
| 28203 | 12,00 | 25x32 (A4) | 10 | Ref.: 28211, 28231, 28341, 28341, 28391 |
| 28451 | 12,20 | 23x31 | 10 | Ref.: 28411, 28431 (doble-doble) |
| 28452 | 10,60 | 17x32 | 10 | Ref.: 28412, 28432 (doble-doble) |
| 28453 | 7,50 | 16,5x23,5 | 10 | Ref.: 28413, 28433 (doble-doble) |
| 66890 | 12,20 | 22x31 (A4) | 10 | Ref.: 66858, 66860, 66859 (doble-doble) |
| 66891 | 10,50 | 16,5x31 | 10 | Ref.: 66861, 66863, 66862 (doble-doble) |
| 66892 | 7,50 | 16x22 (A5) | 10 | Ref.: 66864, 66866, 66865 (doble-doble) |



Set 12 cantoneras

Jeu 12 coins · 12 Tlg. Kantenschutz
Set 12 angle irons · Set 12 cantoneiras

| Ref | € | Color | U.Venta |
|-------|------|----------------|---------|
| 28195 | 5,20 | Negro · Black | 1 |
| 28197 | 5,20 | Oro · Gold | 1 |
| 28198 | 5,20 | Plata · Silver | 1 |



Set 12 tornillos rosca

Jeu 12 vis · 12 Tlg. Schrauben
Set 12 screws · Set 12 parafusos

| Ref | € | Color | U.Venta |
|-------|-------|----------------|---------|
| 28196 | 10,90 | Plata · Silver | 1 |
| 28199 | 11,20 | Negro · Black | 1 |



Set 12 cordones de cuero

Jeu 12 cordons en cuir · 12 Tlg. Lederschnur
Set 12 leather laces · Set 12 cordões de couro

| Ref | € | m | Color | U.Venta |
|-------|------|---|----------------|---------|
| 28200 | 1,50 | 1 | Marrón · Brown | 12 |

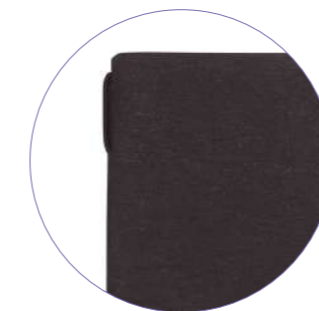

Set 10 gomas

Jeu 10 élastiques · 10 Tlg. Gummis
Set 10 elastic bands · Set 10 elásticos

| Ref | € | Color | U.Venta | Compatible |
|-------|------|---------------|---------|--------------------------|
| 28205 | 7,40 | Negro · Black | 1 | Ref: 28411, 28412, 28432 |
| 28206 | 7,40 | Negro · Black | 1 | Ref: 28413, 28433 |



Set 12 tornillos laterales

Jeu 12 cordons en cuir · 12 Tlg. Lederschnur
Set 12 leather laces · Set 12 cordões de couro

| Ref | € | Color | U.Venta |
|-------|------|--------|---------|
| 66867 | 8,20 | Gold | 1 |
| 66868 | 8,20 | Silver | 1 |



✓ **Destaca tu marca y personaliza a medida cualquiera de nuestros productos.**

Mettez votre marque en valeur et personnalisez l'un de nos produits.
Highlight your brand and customise any of our products.

✓ **Te ayudamos a diseñar y fabricar tu propio proyecto. ¡Cuéntanos tu idea!**

Nous vous aidons à concevoir et à fabriquer votre propre projet, faites-nous part de votre idée !
We help you to design and manufacture your own project, tell us your idea!

✓ **Estampación en relieve: Disponemos de una amplia variedad de colores, tamaños, etc. para diseñar un producto único.**

Estampage en relief : Nous disposons d'une grande variété de couleurs, de tailles, etc. pour concevoir un produit unique.
Embossed stamping: We have a wide variety of colours, sizes, etc. to design a unique product.

¿Cómo? Comment? How?



1

Envíanos tu archivo vectorizado (formato .ai)

Envoyez-nous votre fichier vectorisé (format .ai)
Send us your vectorised file (.ai format)

¿No dispones de ello? Vous ne l'avez pas ? Don't you have it?



Nosotros te lo diseñamos (Coste 20€)

Nous le concevons pour vous (Coût 20€)
We design it for you (Cost 20€)



2

Selecciona la posición · Sélectionner la position · Select the position



3

Selecciona el color · Sélectionner la couleur · Select colour

✓ **Cantidad mínima para personalización a partir de 15 unidades**

Quantité minimale pour la personnalisation à partir de 15 unités
Minimum quantity for personalisation from 15 units onwards

✓ **Precio por personalización del sello: 46€**

Prix pour la personnalisation du timbre : 46€
Price for stamp personalisation: 46€

✓ **El plazo de entrega para los portamenús personalizados es de 15 días naturales**

Le délai de livraison des porte-menus personnalisés est de 15 jours calendaires
The delivery period for the personal portamenús is 15 calendar days

A



B



C



D



Color · Couleur · Colour

En seco (sin color) · Dry (without colour)

Blanco · White

Negro · Black

Rojo · Red

Oro · Gold

Azul · Blue

Plata · Silver

Crema · Cream

Marrón · Brown

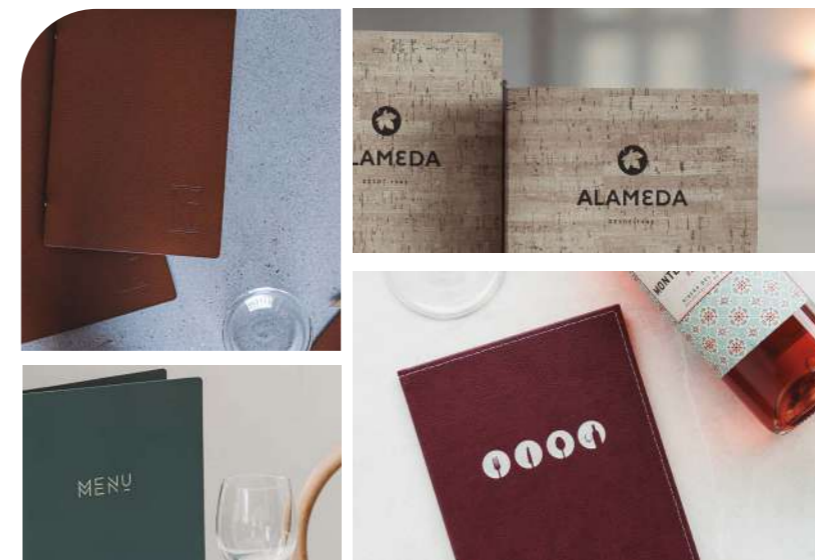

Nota · Note:

★ **No se recomienda la estampación en seco en las siguientes colecciones:**

Dry printing is not recommended in the following collections:

Lisa · Velázquez · Helen · Tomasso · André · Matisse · Charlotte · Degas · Cassat · Edgar · Sophie · Paul · Goya · Marcel · Andy · Natutal · Tex

★ **Material Simil-Piel material:**

Se recomienda personalizar en color blanco, azul, negro, rojo o marrón.

It is recommended to customize in white, blue, black, red or brown colour.

¿Otra idea?

Une autre idée ? · Another idea?



100% personalizables; forma, tamaño, etc.

100% personnalisable ; forme, taille, etc.
100% customisable; shape, size, etc.

¿Alguna duda? ¡Consúltenos!

Avez-vous des doutes ? Demandez-nous !
Do you have any doubts? Please ask us!



Comercial@lacor.es
export@lacor.es



Nacional: +34 943 76 90 30
Export: +34 943 76 91 74



Recycled leather

new

- Fabricado en cuero 100% reciclado (80% de cuero y un 20% de caucho natural).
- Certificado OEKO-TEX®.
- Producido artesanalmente en España.
- Máxima calidad; duraderos y resistentes.
- Espesor de 1,6 mm.
- Fácil de limpiar (no utilizar jabones abrasivos). Incluye
- 4 fundas dobles (8 caras).
- 100% personalizables: diseñamos y customizamos a tu gusto.

- Fabriqué en cuir recyclé à 100 % (80 % de cuir et 20 % de caoutchouc naturel).
- Certificat OEKO-TEX®.
- Fabriqué à la main en Espagne.
- Qualité supérieure ; durable et résistant.
- Épaisseur de 1,6 mm.
- Facile à nettoyer (ne pas utiliser de savons abrasifs).
- 4 intercalaires (8 vues).
- 100% personnalisable : nous concevons et personnalisons selon vos goûts.

- Made of 100% recycled leather (80% leather and 20% natural rubber).
- OEKO-TEX® certified.
- Handcrafted in Spain.
- Maximum quality; durable and resistant.
- Thickness of 1.6 mm.
- Easy to clean (do not use abrasive soaps).
- Include 4 double covers (8 sides).
- 100% customisable: we design and customise to your taste.

SAURA

MATERIAL: Cuero reciclado · Recycled leather

SELLO · SEAL: Termosellado en color crema · Heat-sealed in cream colour

FIJACIÓN · FIXINGS: Remache lateral. Color oro · Side rivet. Gold colour



Blando - Soft

Porta menú Saura

Porte-menu · Speisekartenmappe
Menu cover · Porta-menu

| | Ref | € | cm | Fundas | U.Venta |
|---|-------|-------|-------------|--------|---------|
| A | 66858 | 24,80 | 32x23(A4) | 4 | 4 |
| B | 66861 | 21,20 | 32x17,5 | 4 | 4 |
| C | 66864 | 19,10 | 23,5x17(A5) | 4 | 4 |



SIMONE

MATERIAL: Cuero reciclado · Recycled leather

SELLO · SEAL: Termosellado en seco · Dry heat-sealed

FIJACIÓN · FIXINGS: Remache lateral. Color oro · Side rivet. Gold colour



Blando - Soft

Porta menú Simone

Porte-menu · Speisekartenmappe
Menu cover · Porta-menu

| | Ref | € | cm | Fundas | U.Venta |
|---|-------|-------|--------------|--------|---------|
| A | 66860 | 24,80 | 32X23(A4) | 4 | 4 |
| B | 66863 | 21,20 | 32x17,5 | 4 | 4 |
| C | 66866 | 19,10 | 23,5x17 (A5) | 4 | 4 |



BOSCO

MATERIAL: Cuero reciclado · Recycled leather

SELLO · SEAL: Termosellado en color gris · Heat-sealed in grey colour

FIJACIÓN · FIXINGS: Remache lateral. Color plata · Side rivet. Silver colour



Blando - Soft

Porta menú Bosco

Porte-menu · Speisekartenmappe
Menu cover · Porta-menu

| | Ref | € | cm | Fundas | U.Venta |
|---|-------|-------|--------------|--------|---------|
| A | 66859 | 24,80 | 32x23 (A4) | 4 | 4 |
| B | 66862 | 21,20 | 32x17,5 | 4 | 4 |
| C | 66865 | 19,10 | 23,5x17 (A5) | 4 | 4 |



Portafacturas Bosco

Porte-factures · Halter für Rechnungen
Ticket holder · Porta facturas

| | Ref | € | cm | U.Venta |
|--|-------|-------|---------|---------|
| | 66848 | 18,10 | 11x18,5 | 4 |

NATURAL



MATERIAL: Fibra de celulosa · Celulose fibre

SELLO · SEAL: Termosellado en color negro · Heat-sealed in black colour

FIJACIÓN · FIXINGS: Sujeción con goma · Closes with elastic band



Blando - Soft

Porta menú Natural

Porte-menu · Speisekartenmappe
Menu cover · Porta menu

| | Ref | € | cm | Fundas | U.Venta |
|----------|-------|-------|----------------|--------|---------|
| A | 28411 | 21,40 | 23x32 (A4) | 4 | 4 |
| B | 28412 | 19,70 | 17x32 | 6 | 4 |
| C | 28413 | 17,50 | 16,5x23,5 (A5) | 6 | 4 |



TEX



MATERIAL: Fibra de celulosa · Celulose fibre

SELLO · SEAL: Termosellado en color negro · Heat-sealed in black colour

FIJACIÓN · FIXINGS: Sujeción con goma · Closes with elastic band



Blando - Soft

Porta menú Tex

Porte-menu · Speisekartenmappe
Menu cover · Porta menu

| | Ref | € | cm | Fundas | U.Venta |
|----------|-------|-------|----------------|--------|---------|
| A | 28431 | 21,40 | 23x32 (A4) | 4 | 4 |
| B | 28432 | 19,70 | 17x32 | 6 | 4 |
| C | 28433 | 17,50 | 16,5x23,5 (A5) | 6 | 4 |



HELEN



MATERIAL: Simil - Piel

SELLO · SEAL: Termosellado en color marrón · Heat-sealed in brown colour

FIJACIÓN · FIXINGS: Cordón de cuero · Leather cord

Porta menú Helen

Porte-menu · Speisekartenmappe
Menu cover · Porta menu

| | Ref | € | cm | Fundas | U.Venta |
|----------|-------|-------|--------------|--------|---------|
| A | 28341 | 26,20 | 25,5x32 (A4) | 3 | 4 |
| B | 28342 | 21,50 | 19,5 x 32 | 3 | 4 |
| C | 28343 | 20,20 | 19x23,5 (A5) | 3 | 4 |

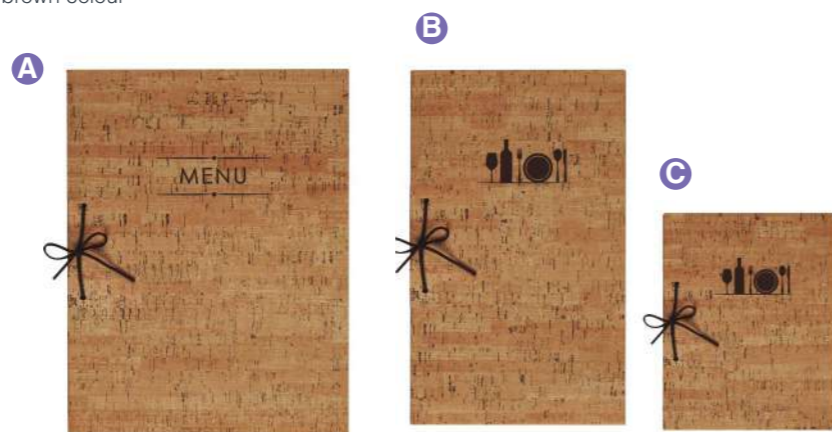

VELÁZQUEZ



MATERIAL: Simil - Piel

SELLO · SEAL: Termosellado en color marrón · Heat-sealed in brown colour

FIJACIÓN · FIXINGS: Fundas fija · Fixed covers

Porta menú Velázquez

Porte-menu · Speisekartenmappe
Menu cover · Porta menu

| | Ref | € | cm | Fundas | U.Venta |
|----------|-------|-------|--------------|--------|---------|
| A | 28331 | 25,10 | 23x32 (A4) | 4 | 4 |
| B | 28332 | 20,00 | 16x28,5 | 4 | 4 |
| C | 28333 | 19,10 | 17x23,5 (A5) | 4 | 4 |

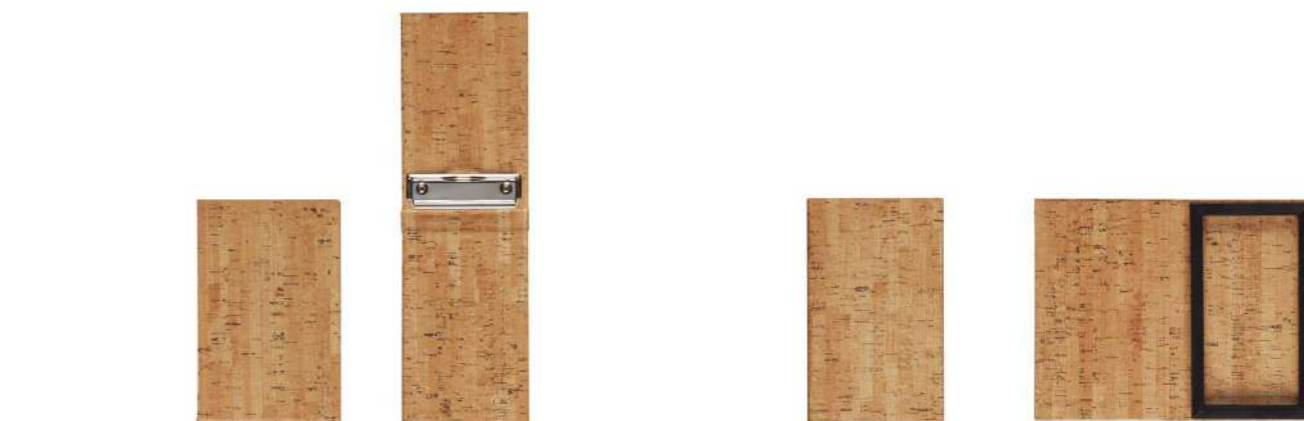
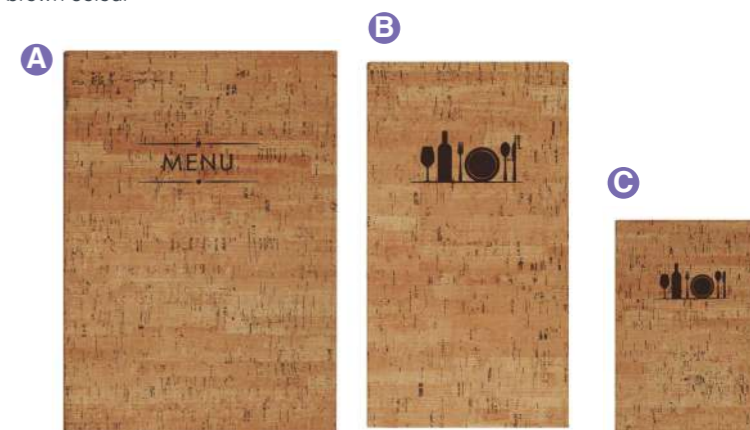

Portacomandas Velázquez

Porte-commandes · Halter für Bestellungen
Order holder · Porta comandas

| Ref | € | cm | U.Venta |
|-------|-------|---------|---------|
| 28175 | 12,30 | 11x17,5 | 4 |

Portafacturas Velázquez

Porte-factures · Halter für Rechnungen
Ticket holder · Porta faturas

| Ref | € | cm | U.Venta |
|-------|-------|---------|---------|
| 28176 | 19,70 | 11x18,5 | 4 |

LISA



MATERIAL: Simil - Piel

SELLO · SEAL: Termosellado en color marrón · Heat-sealed in brown colour

FIJACIÓN · FIXINGS: Solapas fijas · Fixed flaps

Portamenú Lisa

Porte-menu · Speisekartenmappe
Menu cover · Porta menu

| Ref | € | cm | U.Venta |
|-------|-------|--------------|---------|
| 28177 | 22,90 | 23 x 32 (A4) | 4 |



SANDRO



MATERIAL: Teflex

SELLO · SEAL: Termosellado en color azul · Heat-sealed in blue colour

FIJACIÓN · FIXINGS: Atornillado exterior · Exterior screwed

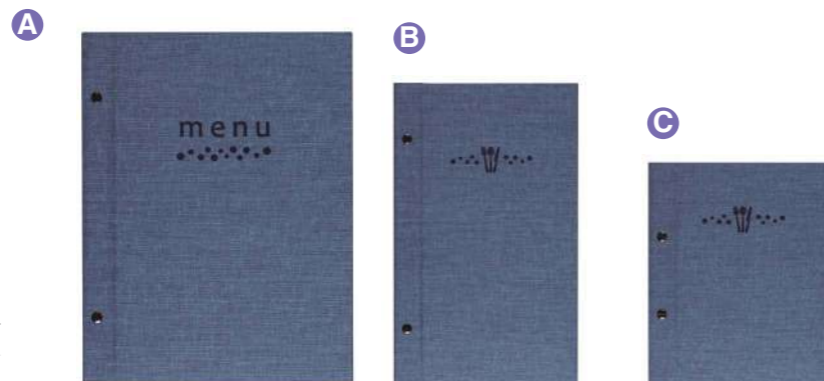

Porta menú Sandro

Porte-menu · Speisekartenmappe
Menu cover · Porta menu

| | Ref | € | cm | Fundas | U.Venta |
|---|-------|-------|--------------|--------|---------|
| A | 28371 | 25,40 | 25,5x32 (A4) | 3 | 4 |
| B | 28372 | 20,80 | 19,5x32 | 3 | 4 |
| C | 28373 | 19,40 | 19x23,5 (A5) | 3 | 4 |



Portacomandas Sandro

Porte-commandes · Halter für Bestellungen
Order holder · Porta comandas

| | Ref | € | cm | U.Venta |
|--|-------|-------|---------|---------|
| | 28375 | 11,90 | 11x17,5 | 4 |

Porta facturas Sandro

Porte-factures · Halter für Rechnungen
Ticket holder · Porta facturas

| | Ref | € | cm | U.Venta |
|--|-------|-------|---------|---------|
| | 28376 | 19,00 | 11x18,5 | 4 |

RENÉ



MATERIAL: Simil-Piel

SELLO · SEAL: Termosellado en color crema · Heat-sealed in cream colour

FIJACIÓN · FIXINGS: Fundas fijas · Fixed covers

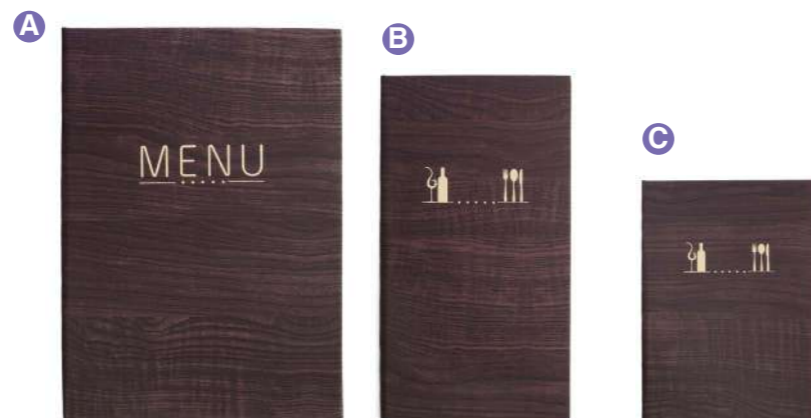

Porta menú René

Porte-menu · Speisekartenmappe
Menu cover · Porta menu

| | Ref | € | cm | Fundas | U.Venta |
|---|-------|-------|--------------|--------|---------|
| A | 28021 | 25,10 | 23x32 (A4) | 4 | 4 |
| B | 28022 | 19,10 | 16x28,5 | 4 | 4 |
| C | 28023 | 20,00 | 17x23,5 (A5) | 4 | 4 |

NICOLÁS



MATERIAL: Simil-Piel

SELLO · SEAL: Termosellado en color crema · Heat-sealed in cream colour

FIJACIÓN · FIXINGS: Atornillado interior · Interior screwed



Blando - Soft

Porta menú Nicolás

Porte-menu · Speisekartenmappe
Menu cover · Porta menu

| | Ref | € | cm | Fundas | U.Venta |
|---|-------|-------|--------------|--------|---------|
| A | 28510 | 38,70 | 25,5x32 (A4) | 3 | 4 |
| B | 28511 | 33,00 | 18x28,5 | 3 | 4 |
| C | 28512 | 33,60 | 19x23,5 (A5) | 3 | 4 |



ANDRÉ



MATERIAL: Teflex

SELLO · SEAL: Termosellado en color crema · Heat-sealed in cream colour

FIJACIÓN · FIXINGS: Sujeción fija · Fixed covers

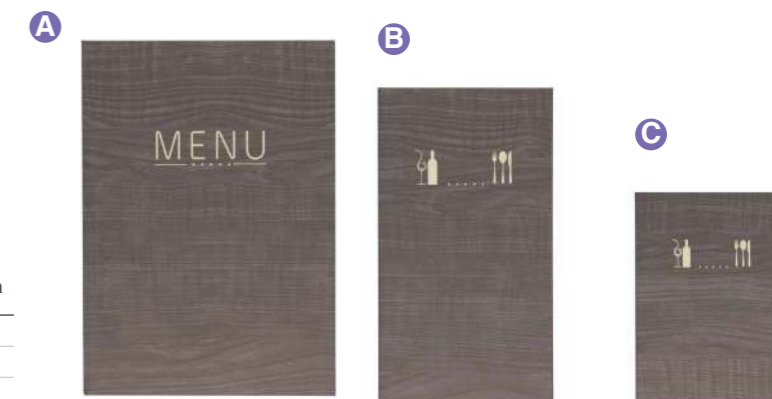

Porta menú André

Porte-menu · Speisekartenmappe
Menu cover · Porta menu

| | Ref | € | cm | Fundas | U.Venta |
|---|-------|-------|--------------|--------|---------|
| A | 28031 | 21,80 | 23x32 (A4) | 4 | 4 |
| B | 28032 | 16,30 | 16x28,5 | 4 | 4 |
| C | 28033 | 17,00 | 17x23,5 (A5) | 4 | 4 |

CÉZANNE



MATERIAL: Simil-Piel

SELLO · SEAL: Termosellado en color crema · Heat-sealed in cream colour

FIJACIÓN · FIXINGS: Solapas · Fixed flaps



Porta menú Cézanne

Porte-menu · Speisekartenmappe
Menu cover · Porta menu

| | Ref | € | cm | U.Venta |
|--|-------|-------|------------|---------|
| | 28041 | 20,80 | 23x32 (A4) | 4 |

LEO



MATERIAL: Simil-Piel
SELLO · SEAL: Termosellado en color crema · Heat-sealed in cream colour
FIJACIÓN · FIXINGS: 3 solapas fijas · 3 fixed flaps

Porta menú Leo
 Porte-menu · Speisekartenmappe
 Menu cover · Porta menu

| Ref | € | cm | Solapas | U.Venta |
|-------|-------|------------|---------|---------|
| 28151 | 30,30 | 23x32 (A4) | 3 | 4 |



TIZIANO



MATERIAL: Simil-Piel
SELLO · SEAL: Termosellado en color crema · Heat-sealed in cream colour
FIJACIÓN · FIXINGS: 3 solapas fijas · 3 fixed flaps

Porta menú Tiziano
 Porte-menu · Speisekartenmappe
 Menu cover · Porta menu

| Ref | € | cm | Solapas | U.Venta |
|-------|-------|------------|---------|---------|
| 28172 | 27,70 | 17x24 (A5) | 3 | 4 |



CLAUDIO



MATERIAL: Simil-Piel
FIJACIÓN · FIXINGS: Pinza metálica · Metal clip

Porta menú Claudio
 Porte-menu · Speisekartenmappe
 Menu cover · Porta menu

| Ref | € | cm | U.Venta |
|-------|-------|---------------|---------|
| 28321 | 17,50 | 23,5x33,5(A4) | 4 |



MATISSE



MATERIAL: Simil-Piel
SELLO · SEAL: Termosellado en color negro · Heat-sealed in black colour
FIJACIÓN · FIXINGS: Fundas fijas · Fixed covers

Porta menú Matisse
 Porte-menu · Speisekartenmappe
 Menu cover · Porta menu

| Ref | € | cm | Fundas | U.Venta |
|---------|-------|--------------|--------|---------|
| A 28051 | 25,10 | 23x32 (A4) | 4 | 4 |
| B 28052 | 19,10 | 16x28,5 | 4 | 4 |
| C 28053 | 20,00 | 17x23,5 (A5) | 4 | 4 |



CHARLOTTE



MATERIAL: Simil-Piel
SELLO · SEAL: Termosellado en color negro · Heat-sealed in black colour
FIJACIÓN · FIXINGS: Atornillado interior · Interior screwed



Blando - Soft

Porta menú Charlotte
 Porte-menu · Speisekartenmappe
 Menu cover · Porta menu

| Ref | € | cm | Fundas | U.Venta |
|---------|-------|--------------|--------|---------|
| A 28530 | 38,70 | 25,5x32 (A4) | 3 | 4 |
| B 28531 | 33,60 | 18x28,5 | 3 | 4 |
| C 28532 | 33,00 | 19x23,5 (A5) | 3 | 4 |

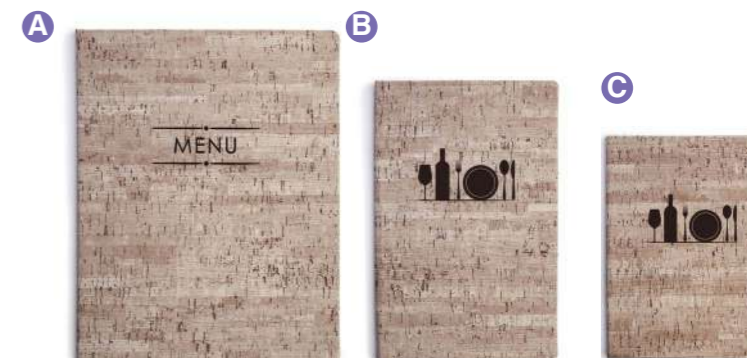

TOMASSO



MATERIAL: Simil-Piel
SELLO · SEAL: Termosellado en color negro · Heat-sealed in black colour
FIJACIÓN · FIXINGS: Atornillado exterior · Exterior screwed

Porta menú Tomasso
 Porte-menu · Speisekartenmappe
 Menu cover · Porta menu

| Ref | € | cm | Fundas | U.Venta |
|---------|-------|--------------|--------|---------|
| A 28351 | 26,50 | 25,5x32 (A4) | 3 | 4 |
| B 28352 | 21,80 | 19,5x32 | 3 | 4 |
| C 28353 | 20,50 | 19x23,5 (A5) | 3 | 4 |



DEGAS



MATERIAL: Simil-Piel
SELLO · SEAL: Termosellado en color negro · Heat-sealed in black colour
FIJACIÓN · FIXINGS: Solapas · Fixed flaps



Porta menú Degas
 Porte-menu · Speisekartenmappe
 Menu cover · Porta menu

| Ref | € | cm | U.Venta |
|-------|-------|------------|---------|
| 28141 | 22,90 | 23x32 (A4) | 4 |

GOYA



MATERIAL: Simil-Piel
SELLO · SEAL: Termosellado en color negro · Heat-sealed in black colour
FIJACIÓN · FIXINGS: 3 solapas fijas · 3 fixed flaps



Porta menú Goya
 Porte-menu · Speisekartenmappe
 Menu cover · Porta menu

| Ref | € | cm | Solapas | U.Venta |
|-------|-------|------------|---------|---------|
| 28161 | 30,30 | 23x32 (A4) | 3 | 4 |

MARCEL



MATERIAL: Simil-Piel
SELLO · SEAL: Termosellado en color negro · Heat-sealed in black colour
FIJACIÓN · FIXINGS: 3 solapas fijas · 3 fixed flaps



Porta menú Marcel
 Porte-menu · Speisekartenmappe
 Menu cover · Porta menu

| Ref | € | cm | Solapas | U.Venta |
|-------|-------|------------|---------|---------|
| 28182 | 27,70 | 17x24 (A5) | 3 | 4 |

CASSAT



MATERIAL: Teflex
SELLO · SEAL: Termosellado en color negro · Heat-sealed in black colour
FIJACIÓN · FIXINGS: Sujeción fija · Fixed covers

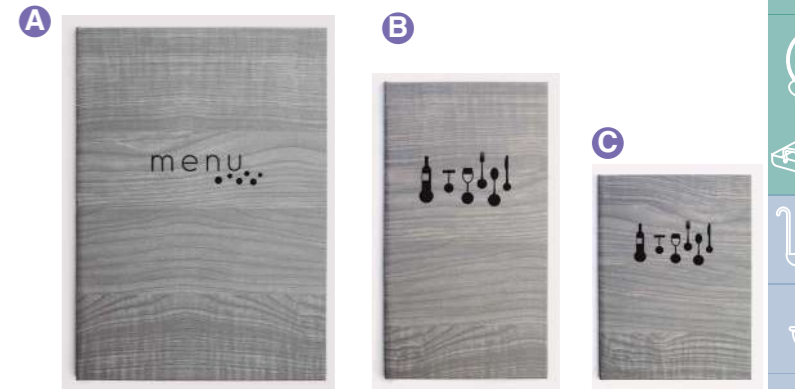

Porta menú Cassat
 Porte-menu · Speisekartenmappe
 Menu cover · Porta menu

| | Ref | € | cm | Fundas | U.Venta |
|---|-------|-------|--------------|--------|---------|
| A | 28061 | 21,80 | 23x32 (A4) | 4 | 4 |
| B | 28062 | 16,30 | 16x28,5 | 4 | 4 |
| C | 28063 | 17,00 | 17x23,5 (A5) | 4 | 4 |

EDGAR



MATERIAL: Teflex
SELLO · SEAL: Termosellado en color negro · Heat-sealed in black colour
FIJACIÓN · FIXINGS: Atornillado exterior · Interior screwed



Porta menú Edgar
 Porte-menu · Speisekartenmappe
 Menu cover · Porta menu

| Ref | € | cm | Fundas | U.Venta |
|-------|-------|--------------|--------|---------|
| 28540 | 23,00 | 25,5x32 (A4) | 3 | 4 |

MAX



MATERIAL: Teflex
FIJACIÓN · FIXINGS: Pinza metálica · Metal clip



Porta menú Max
 Porte-menu · Speisekartenmappe
 Menu cover · Porta menu

| Ref | € | cm | U.Venta |
|-------|-------|---------------|---------|
| 28311 | 14,10 | 23,5x33,5(A4) | 4 |

DALÍ



MATERIAL: Simil-Piel
SELLO · SEAL: Termosellado en color blanco · Heat-sealed in white colour
FIJACIÓN · FIXINGS: Fundas fijas · Fixed covers

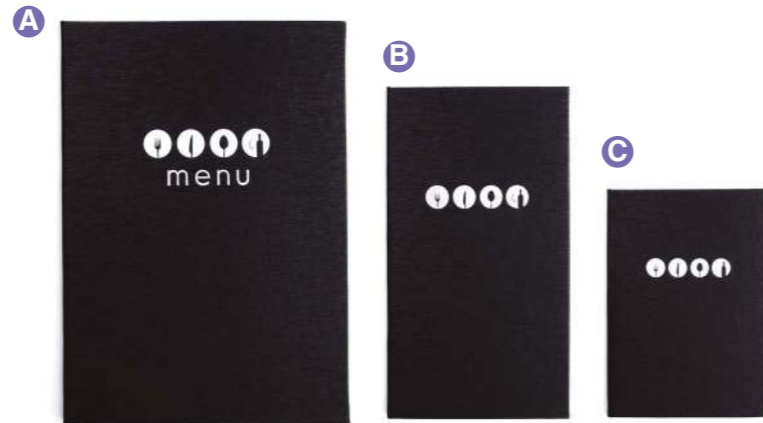

Porta menú Dalí
 Porte-menu · Speisekartenmappe
 Menu cover · Porta menu

| | Ref | € | cm | Fundas | U.Venta |
|---|-------|-------|--------------|--------|---------|
| A | 28101 | 23,30 | 23x32 (A4) | 4 | 4 |
| B | 28102 | 17,90 | 16x28,5 | 4 | 4 |
| C | 28103 | 18,80 | 17x23,5 (A5) | 4 | 4 |

MARIE



MATERIAL: Simil-Piel
SELLO · SEAL: Termosellado en color blanco · Heat-sealed in white colour
FIJACIÓN · FIXINGS: Solapas fijas · Fixed flaps



Porta menú Marie
 Porte-menu · Speisekartenmappe
 Menu cover · Porta menu

| | Ref | € | cm | U.Venta |
|--|-------|-------|------------|---------|
| | 28560 | 20,50 | 23x32 (A4) | 4 |

FRIDA



MATERIAL: Simil-Piel
SELLO · SEAL: Termosellado en color negro · Heat-sealed in black colour
FIJACIÓN · FIXINGS: Fundas fijas · Fixed covers

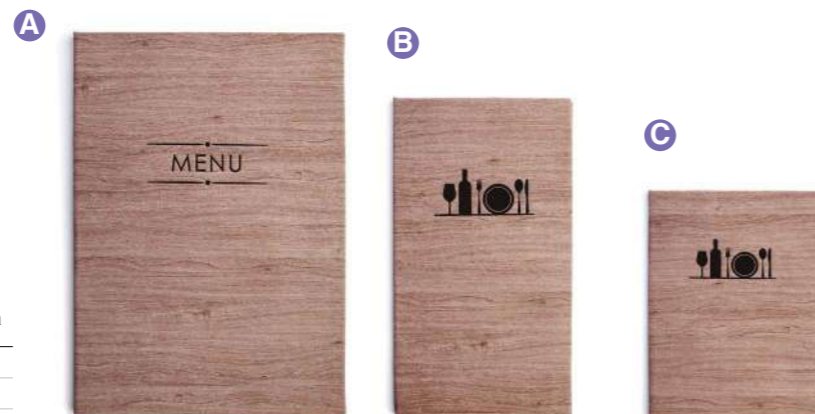

Porta menú Frida
 Porte-menu · Speisekartenmappe
 Menu cover · Porta menu

| | Ref | € | cm | Fundas | U.Venta |
|---|-------|-------|--------------|--------|---------|
| A | 28011 | 25,10 | 23x32 (A4) | 4 | 4 |
| B | 28012 | 19,10 | 16x28,5 | 4 | 4 |
| C | 28013 | 20,00 | 17x23,5 (A5) | 4 | 4 |

VERMEER



MATERIAL: Simil-Piel
SELLO · SEAL: Termosellado en color negro · Heat-sealed in black colour
FIJACIÓN · FIXINGS: Atornillado interior · Interior screwed



Blando - Soft

Porta menú Vermeer
 Porte-menu · Speisekartenmappe
 Menu cover · Porta menu

| | Ref | € | cm | Fundas | U.Venta |
|---|-------|-------|--------------|--------|---------|
| A | 28500 | 38,70 | 25,5x32 (A4) | 3 | 4 |
| B | 28501 | 33,00 | 18x28,5 | 3 | 4 |
| C | 28502 | 33,60 | 19x23,5 (A5) | 3 | 4 |

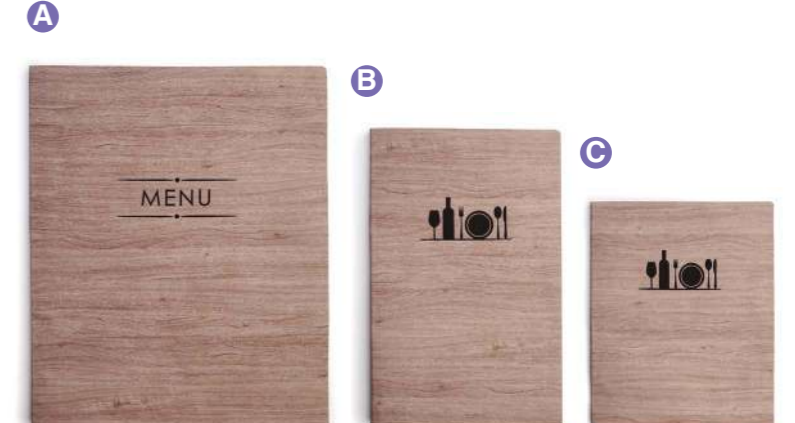

SOPHIE



MATERIAL: Teflex
SELLO · SEAL: Termosellado en color negro · Heat-sealed in black colour
FIJACIÓN · FIXINGS: Fundas fijas · Fixed covers

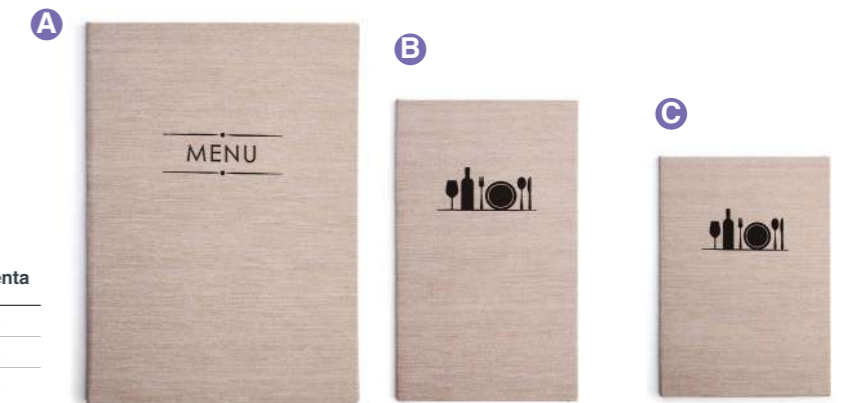

Porta menú Sophie
 Porte-menu · Speisekartenmappe
 Menu cover · Porta menu

| | Ref | € | cm | Fundas | U.Venta |
|---|-------|-------|--------------|--------|---------|
| A | 28081 | 22,40 | 23x32 (A4) | 4 | 4 |
| B | 28082 | 17,00 | 16x28,5 | 4 | 4 |
| C | 28083 | 17,50 | 17x23,5 (A5) | 4 | 4 |

PAUL



MATERIAL: Teflex
SELLO · SEAL: Termosellado en color negro · Heat-sealed in black colour
FIJACIÓN · FIXINGS: Atornillado exterior · Interior screwed



Porta menú Paul
 Porte-menu · Speisekartenmappe
 Menu cover · Porta menu

| | Ref | € | cm | Fundas | U.Venta |
|--|-------|-------|--------------|--------|---------|
| | 28550 | 24,90 | 25,5x32 (A4) | 3 | 4 |

PABLO



MATERIAL: Simil-Piel

SELLO · SEAL: Termosellado en color blanco · Heat-sealed in white colour

FIJACIÓN · FIXINGS: Atornillado interior · Interior screwed

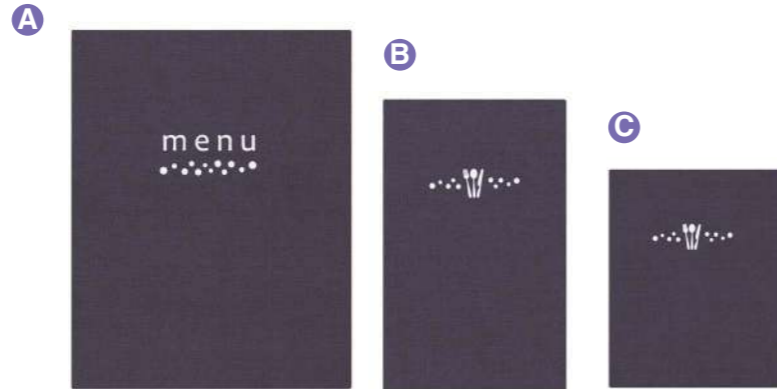

Porta menú Pablo

Porte-menu · Speisekartenmappe
Menu cover · Porta menu

| | Ref | € | cm | Fundas | U.Venta |
|----------|-------|--------------|----------------|--------|---------|
| A | 28211 | 30,80 | 25x32 (A4) | 3 | 4 |
| B | 28212 | 25,80 | 18x28 | 3 | 4 |
| C | 28213 | 24,90 | 19,5x23,5 (A5) | 3 | 4 |

ISABELLE



MATERIAL: Simil-Piel

SELLO · SEAL: Termosellado en color plata · Heat-sealed in silver colour

FIJACIÓN · FIXINGS: Fundas fijas · Fixed covers

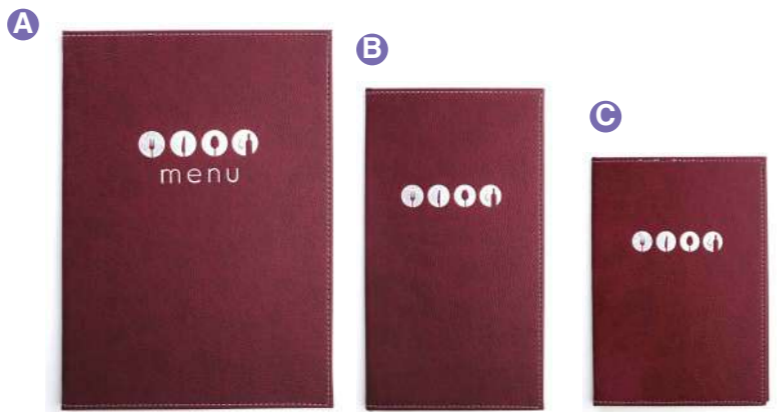

Porta menú Isabelle

Porte-menu · Speisekartenmappe
Menu cover · Porta menu

| | Ref | € | cm | Fundas | U.Venta |
|----------|-------|--------------|--------------|--------|---------|
| A | 28001 | 27,10 | 23x32 (A4) | 4 | 4 |
| B | 28002 | 20,20 | 16x28,5 | 4 | 4 |
| C | 28003 | 21,30 | 17x23,5 (A5) | 4 | 4 |

MILLET



MATERIAL: Simil-Piel

SELLO · SEAL: Termosellado en color negro · Heat-sealed in black colour

FIJACIÓN · FIXINGS: Fundas fijas · Fixed covers

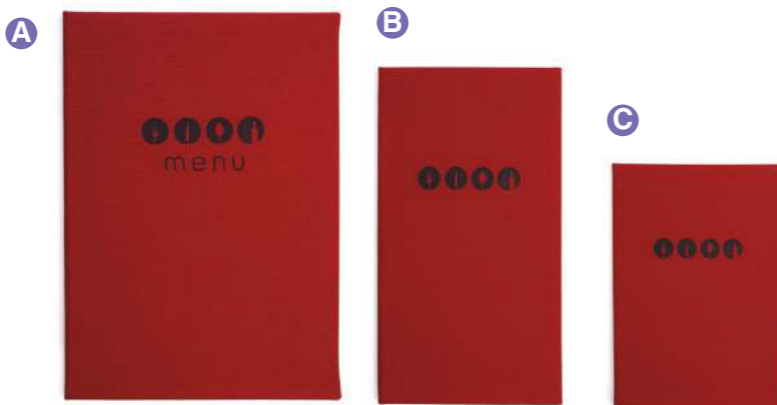

Porta menú Millet

Porte-menu · Speisekartenmappe
Menu cover · Porta menu

| | Ref | € | cm | Fundas | U.Venta |
|----------|-------|--------------|--------------|--------|---------|
| A | 28131 | 23,30 | 23x32 (A4) | 4 | 4 |
| B | 28132 | 17,90 | 16x28,5 | 4 | 4 |
| C | 28133 | 18,80 | 17x23,5 (A5) | 4 | 4 |

Buffet
Buffet





Chafing dish



Chafing dish GN 1/1 Luxe
Chafing dish GN 1/1 · Chafing Dish, GN-Einsatz 1/1
GN 1/1 chafing dish · Chafing dish GN 1/1

| Ref | € | cm | h (cm) | L | U.Venta |
|-------|---------|---------|--------|-----|---------|
| 69091 | 1038,20 | 47x59,5 | 43,0 | 9,0 | 1 |



Chafing dish GN 1/1 Luxe Cuerpo
Corps chafing dish GN 1/1 · Chafing Dish Körpe, GN-Einsatz 1/1
GN 1/1 chafing dish body · Corpo chafing dish GN 1/1

| Ref | € | cm | h (cm) | L | U.Venta |
|-------|--------|---------|--------|-----|---------|
| 69099 | 835,30 | 59,5x47 | 25,0 | 9,0 | 1 |

Placa encastrable. Necesita agujero de Ø216 mm para introducirla
Encastable plate. Need a Ø216 mm hole to insert the plate



Placa de inducción para chafing dish 1000W
Plaque à induction a/regulateur · Induktionskochfeld m/ regler
Round induction plate with power control · Placa de indução com regulador

| Ref | € | W | cm | U.Venta |
|-------|--------|------|-------|---------|
| 69131 | 117,00 | 1000 | Ø24x8 | 1 |



Chafing dish GN 1/1 Luxe Soporte
Support chafing dish GN 1/1 · Gestell für Chafing Dish1/1
GN 1/1 chafing dish stand · Suporte chafing dish GN 1/1

| Ref | € | cm | h (cm) | U.Venta |
|-------|--------|-------|--------|---------|
| 69089 | 202,80 | 41x55 | 17,0 | 1 |



Aro completo chafing dish
Support plaque induction · Zusatzring chafing-dish
Chafing-dish heater holde · Aro complemento chafing dish

| Ref | € | Ø (cm) | U.Venta |
|---------|-------|--------|---------|
| R69099B | 19,20 | 26 | 1 |



Salsera para chafing dish
Saucière chafing-dish · Sauciere Chafing Dish
Gravy spoon holder · Molheira chafing dish

| Ref | € | cm | h(cm) | L | U.Venta |
|---------|-------|-------|-------|------|---------|
| R69099C | 16,30 | 12x23 | 4,0 | 0,40 | 1 |

Chafing dish GN 2/3 Luxe
Chafing dish GN 2/3 · Chafing Dish, GN-Einsatz 2/3
GN 2/3 chafing dish · Chafing dish GN 2/3

| Ref | € | cm | h (cm) | L | U.Venta |
|-------|--------|-------|--------|-----|---------|
| 69092 | 826,70 | 43x46 | 58,5 | 5,5 | 1 |



Chafing dish GN 2/3 Luxe Cuerpo
Corps chafing dish GN 2/3 · Chafing Dish Körpe, GN-Einsatz 2/3
GN 2/3 chafing dish body · Corpo chafing dish GN 2/3

| Ref | € | cm | h(cm) | L | U.Venta |
|-------|--------|-------|-------|-----|---------|
| 69095 | 653,00 | 46x43 | 25,5 | 5,5 | 1 |

Placa encastrable. Necesita agujero de Ø216 mm para introducirla
Encastable plate. Need a Ø216 mm hole to insert the plate



Placa de inducción para chafing dish 1000W
Plaque à induction a/regulateur · Induktionskochfeld m/ regler
Round induction plate with power control · Placa de indução com regulador

| Ref | € | W | cm | U.Venta |
|-------|--------|------|-------|---------|
| 69131 | 117,00 | 1000 | Ø24x8 | 1 |



Chafing dish GN 2/3 Luxe Soporte
Support chafing dish GN 2/3 · Gestell für Chafing Dish 2/3
GN 2/3 chafing dish stand · Suporte chafing dish GN 2/3

| Ref | € | cm | h(cm) | U.Venta |
|-------|--------|-------|-------|---------|
| 69087 | 173,70 | 40x37 | 17,0 | 1 |



Aro completo chafing dish
Support plaque induction · Zusatzring chafing-dish
Chafing-dish heater holde · Aro complemento chafing dish

| Ref | € | Ø (cm) | U.Venta |
|---------|-------|--------|---------|
| R69099B | 19,20 | 26 | 1 |



Salsera para chafing dish
Saucière chafing-dish · Sauciere Chafing Dish
Gravy spoon holder · Molheira chafing dish

| Ref | € | cm | h(cm) | L | U.Venta |
|---------|-------|-------|-------|------|---------|
| R69099C | 16,30 | 12x23 | 4,0 | 0,40 | 1 |

Chafing dish GN 1/2 Luxe

Chafing dish GN 1/2 · Chafing Dish, GN-Einsatz 1/2
GN 1/2 chafing dish · Chafing dish GN 1/2 steel

| Ref | € | cm | h(cm) | L | U.Venta |
|-------|--------|---------|-------|-----|---------|
| 69093 | 745,00 | 32,5x46 | 44,5 | 4,0 | 1 |



Chafing dish GN 1/2 Luxe Cuerpo

Corps chafing dish GN 1/2 · Chafing Dish Körper, GN-Einsatz 1/2
GN 1/2 chafing dish body · Corpo chafing dish GN 1/2

| Ref | € | cm | h(cm) | L | U.Venta |
|-------|--------|---------|-------|-----|---------|
| 69094 | 601,60 | 46x32,5 | 25,5 | 4,0 | 1 |



Chafing dish GN 1/2 Luxe Soporte

Support chafing dish GN 1/2 · Gestell für Chafing Dish 1/2
GN 1/2 chafing dish stand · Suporte chafing dish GN 1/2

| Ref | € | cm | h(cm) | U.Venta |
|-------|--------|-------|-------|---------|
| 69088 | 143,30 | 40x28 | 17,0 | 1 |

Chafing dish sopa Luxe

Chafing dish soupere · Suppen Chafing Dish
Soup chafing dish · Chafing dish sopa

| Ref | € | Ø (cm) | h (cm) | L | U.Venta |
|-------|--------|--------|--------|------|---------|
| 69098 | 658,40 | 45 | 57,0 | 11,0 | 1 |



Chafing dish sopa Luxe Cuerpo

Corps chafing dish soupere · Suppen Chafing Dish Körper
Soup chafing dish body · Corpo chafing dish sopa

| Ref | € | Ø (cm) | h (cm) | L | U.Venta |
|-------|--------|--------|--------|------|---------|
| 69100 | 483,90 | 45 | 38,0 | 11,0 | 1 |

Soporte para chafing dish (sopa y redondo Luxe)

Support bain marie soupere · Gestell für Suppen Chafing Dish
Soup chafing dish stand · Suporte chafing dish sopa

| Ref | € | cm | h (cm) | U.Venta |
|-------|--------|-------|--------|---------|
| 69097 | 174,60 | 41x32 | 17,0 | 1 |

Placa encastrable. Necesita agujero de Ø216 mm para introducirla
Encastable plate. Need a Ø216 mm hole to insert the plate



Aro completo chafing dish

Support plaque induction · Zusatzring chafing-dish
Chafing-dish heater holde · Aro complemento chafing dish

| Ref | € | Ø (cm) | U.Venta |
|---------|-------|--------|---------|
| R69094A | 19,40 | 18 | 1 |



Placa encastrable. Necesita agujero de Ø216 mm para introducirla
Encastable plate. Need a Ø216 mm hole to insert the plate



Placa de inducción para chafing dish 1000W

Plaque à induction a/regulateur · Induktionskochfeld m/ regler
Round induction plate with power control · Placa de indução com regulador

| Ref | € | W | cm | U.Venta |
|-------|--------|------|-------|---------|
| 69131 | 117,00 | 1000 | Ø24x8 | 1 |



Aro complemento para chafing dish

Support plaque induction · Zusatzring chafing-dish
Chafing-dish heater holde · Aro complemento chafing dish

| Ref | € | Ø (cm) | U.Venta |
|---------|-------|--------|---------|
| R69100B | 19,80 | 27 | 1 |

Placa de inducción para chafing dish 700W

Plaque à induction a/regulateur · Induktionskochfeld m/ regler
Round induction plate with power control · Placa de indução com regulador

| Ref | € | W | cm | U.Venta |
|-------|--------|-----|-------|---------|
| 69139 | 116,30 | 700 | Ø18x8 | 1 |

Salsera para chafing dish

Saucière chafing-dish · Sauciere Chafing Dish
Gravy spoon holder · Molheira chafing dish

| Ref | € | cm | h(cm) | L | U.Venta |
|---------|-------|-------|-------|------|---------|
| R69099C | 16,30 | 12x23 | 4,0 | 0,40 | 1 |



Salsera para chafing dish

Saucière chafing-dish · Sauciere Chafing Dish
Gravy spoon holder · Molheira chafing dish

| Ref | € | cm | h(cm) | L | U.Venta |
|---------|-------|-------|-------|------|---------|
| R69099C | 16,30 | 12x23 | 4,0 | 0,40 | 1 |



Contenedor chafing dish Luxe Sopa

Réceptier pour chafing dish · Behälter für Chafing Dishes
Chafing dish container · Recipiente para travessas

| Ref | € | Ø (cm) | h(cm) | L | U.Venta |
|---------|-------|--------|-------|------|---------|
| R69100A | 25,80 | 29 | 22,0 | 11,0 | 1 |



Chafing dish redondo Luxe

Chafing dish rounde · Chafing Dish, rund
Round chafing dish · Chafing dish redondo

| Ref | € | cm | h (cm) | L | U.Venta |
|-------|---------------|---------|--------|-----|---------|
| 69101 | 818,20 | 46,5x53 | 45,0 | 6,0 | 1 |



Chafing dish redondo Luxe Cuerpo

Corps chafing dishrounde · Chafing Dish Körper, rund
Round chafing dish body · Corpo chafing dish redondo

| Ref | € | cm | h(cm) | L | U.Venta |
|-------|---------------|---------|-------|-----|---------|
| 69096 | 643,60 | 46,5x53 | 25,0 | 6,0 | 1 |

Placa encastrable. Necesita agujero de Ø216 mm para introducirla
Encastable plate. Need a Ø216 mm hole to insert the plate



Placa de inducción para chafing dish 1000W

Plaque à induction a/regulateur · Induktionskochfeld m/ regler
Round induction plate with power control · Placa de indução com regulador

| Ref | € | W | cm | U.Venta |
|-------|---------------|------|-------|---------|
| 69131 | 117,00 | 1000 | Ø24x8 | 1 |



Salsera para chafing dish

Saucière chafing-dish · Sauciere Chafing Dish
Gravy spoon holder · Molheira chafing dish

| Ref | € | cm | h(cm) | L | U.Venta |
|---------|--------------|-------|-------|------|---------|
| R69099C | 16,30 | 12x23 | 4,0 | 0,40 | 1 |

Soporte para chafing dish (sopa y redondo Luxe)

Support bain marie soupere · Gestell für Suppen Chafing Dish
Soup chafing dish stand · Suporte chafing dish sopa

| Ref | € | cm | h (cm) | U.Venta |
|-------|---------------|-------|--------|---------|
| 69097 | 174,60 | 41x32 | 17,0 | 1 |



Aro complemento para chafing dish

Support plaque induction · Zusatzring chafing-dish
Chafing-dish heater holde · Aro complemento chafing dish

| Ref | € | Ø (cm) | U.Venta |
|---------|--------------|--------|---------|
| R69100B | 19,80 | 27 | 1 |



Fuente para chafing dish redondo

Plat rond pour Bain marie rounde · Einsatz für chafing-dish, rund
Food pan for round chafing-dish · Travessa para chafing dish redondo

| Ref | € | Ø (cm) | U.Venta |
|-------|--------------|--------|---------|
| 69019 | 60,90 | 35x7 | 1 |



INOX
18/10

Chafing dish GN 1/1 roll top Latón

Bain marie GN 1/1 roll top · Chafing Dish, mit GN-Einsatz, Rolldeckel
Chafing dish GN 1/1 roll top · Chafing dish GN 1/1 roll top

| Ref | € | cm | h(cm) | L | U.Venta |
|-------|---------------|---------|-------|-----|---------|
| 69015 | 774,90 | 53x32,5 | 6,50 | 9,0 | 1 |



INOX
18/10

Chafing dish GN 1/1 con tapa Classic

Bain marie GN 1/1 avec couvercle · Chafing Dish, mitGN-Einsatz 1/1 mit Deckel
Chafing Dish GN 1/1 with lid · Chafing Dish GN 1/1 com tampa

| Ref | € | cm | h(cm) | L | U.Venta |
|-------|---------------|-------|-------|-----|---------|
| 69110 | 110,00 | 56x35 | 28,0 | 8,5 | 1 |



INOX

Contenedor de combustible

Porte-bruleur · Brennpasten-Behälter
Burner holder · Recipiente de combustivel

| Ref | € | Ø (cm) | h(cm) | U.Venta |
|-------|--------------|--------|-------|---------|
| 69006 | 10,80 | 9,0 | 6,0 | 1 |



INOX
18/10

Chafing dish GN 1/1 roll top Inox

Bain marie GN 1/1 roll top · Chafing Dish, mit GN-Einsatz, Rolldeckel
Chafing dish GN 1/1 roll top · Chafing dish GN 1/1 roll top

| Ref | € | cm | h(cm) | L | U.Venta |
|-------|---------------|---------|-------|-----|---------|
| 69034 | 695,30 | 53x32,5 | 6,50 | 9,0 | 1 |



A



Adapt. a Ref
69015 - 69001 - 69004 - 69110

INOX



B



Calentador eléctrico para chafing

Corp de chauffe pour bain marie · Heizung für chafing dish
Heating unit for chafing dish · Aquecedor para chafing dish

| Ref | € | W | Temperatura | U.Venta |
|---------|---------------|-----|-------------|---------|
| A 69002 | 190,70 | 700 | 96°C(máx) | 1 |
| B 69012 | 220,60 | 700 | 92°C(máx) | 1 |

A



B



C



D



Gel combustible Etanol

Gel chauffe ETHANOL · Brennpaste, ETHALKOHOL
Fuel gel, ETHANOL · Gel combustivel ETANOL

| Ref | € | Peso (Kg) | Horas | U.Venta | |
|---------|--------------|-----------|--------|---------|-------------------------|
| A 71780 | 4,90 | 0,08 | 80 min | 1 | Set 3 latas · 3 can set |
| B 69108 | 2,80 | 0,225 | 3 | 72 | Lata · Can |
| C 69107 | 8,80 | 0,840 | - | 1 | Botella · Bottle |
| D 69109 | 40,50 | 4,00 | - | 1 | Bidón · Barrel |

INOX  

new



- Diseño elegante, práctico y funcional.
- Fabricada en acero inoxidable de gran calidad.
- Carcasa fabricada en polipropileno.
- Panel de control digital para controlar la temperatura real y la temperatura programada (ajustable entre los 20°C y los 80°C).
- Tapa de acero inoxidable con apertura central y orificio para apoyar el cazo (Ref.: 69680).
- Tapa de vidrio templado con sistema de cierre SoftClosing incluye un tirador con aislamiento térmico (Ref.: 69681-69682).
- Recipiente y tapa fabricadas en acero inoxidable, totalmente extraíbles que garantizan que sea cómodo a la hora de llenarlo y muy fácil de limpiar.
- Ligero y fácil de transportar.
- Pies de goma antideslizantes para mayor estabilidad.

- Design élégant, pratique et fonctionnel.
- Fabriqué en acier inoxydable de haute qualité.
- Boîtier en polypropylène.
- Panneau de commande numérique permettant la température réelle et la température programmée (réglable entre 20°C et 80°C).
- Couvercle en acier inoxydable avec ouverture centrale et trou pour supporter la casserole (Ref.: 69680).
- Couvercle en verre trempé avec système SoftClosing et poignée isolée thermiquement (Ref.: 69681-69682).
- Récipient et couvercle en acier inoxydable, entièrement amovibles pour faciliter le remplissage et le nettoyage.
- Léger et facile à transporter.
- Pieds en caoutchouc antidérapants pour une meilleure stabilité.

- Elegant, practical and functional design.
- Made of high quality stainless steel.
- Housing made of polypropylene.
- Digital control panel to monitor the actual temperature and the programmed temperature (adjustable between 20°C and 80°C).
- Stainless steel lid with central opening and hole to support the saucepan (Ref.: 69680).
- Tempered glass lid with SoftClosing system including thermally insulated handle (Ref.: 69681-69682).
- Stainless steel container and lid, fully removable to ensure convenient filling and easy cleaning.
- Lightweight and easy to transport.
- Non-slip rubber feet for greater stability.

Chafing Dish SOPA NOIR

Soupe pour chafing dish · Chafing Dish Suppe
Chafing Dish Soup · Sopa de Chafing Dish

| Ref | € | W | L | h(cm) | Rango temperatura | U.Venta |
|-------|--------|-----|-----|-------|-------------------|---------|
| 69680 | 229,40 | 400 | 3,2 | 35 | 20°C - 80°C | 1 |



Chafing Dish GN 1/1 NOIR

Casserole GN 1/1 · Chafing Dish GN 1/1
Chafing Dish GN 1/1 · Sopa de Chafing Dish

| Ref | € | W | L | h(cm) | Rango temperatura | U.Venta |
|-------|--------|-----|-----|-------|-------------------|---------|
| 69681 | 292,10 | 600 | 6,0 | 20 | 20°C-80°C | 1 |



Chafing Dish GN 2/3 NOIR

Casserole GN 2/3 · Chafing Dish GN 2/3
Chafing Dish GN 2/3 · Sopa de Chafing GN 2/3

| Ref | € | W | L | h (cm) | Rango temperatura | U.Venta |
|-------|--------|-----|-----|--------|-------------------|---------|
| 69682 | 274,40 | 600 | 4,0 | 20 | 20°C - 80°C | 1 |

Combinaciones posibles de cubetas · Possible tray options



INOX  

Chafing dish eléctrico

Chafing dish électrique · Elektrische Chafing Dish
Electric chafing dish · Chafing dish eléctrico

| Ref | € | W | L | U.Venta |
|-------|--------|-----|-------|---------|
| 69336 | 183,00 | 900 | 8,5 L | 1 |

- Ideal para el sector de la hostelería, restauración y catering.
- Mantiene la temperatura de los alimentos.
- Más seguro al carecer de llama de los geles.
- Tapa y cubeta extraíble GN 1/1 h=65 mm (8,50 L) fabricados en acero inoxidable de alta calidad. Cuerpo fabricado en polipropileno.
- Termostato regulable (85°C +/-10°C).
- Interruptor de encendido y apagado. Indicador luminoso.
- Protección contra sobrecalentamiento.
- Fácil de transportar gracias a sus asas laterales.
- 6 pies antideslizantes y resistentes para mantener la estabilidad.

- Ideal for the hospitality, restoration and catering sector.
- Keep the food temperature.
- Safer lacking the flame of the gels.
- Removable lid and cubeta Gn 1/1 h = 65 mm (8.50 l) Manufactured in high quality stainless steel. Body manufactured in polypropylene.
- Adjustable thermostat (85 ° C +/- 10 ° C).
- Switch on and off. Luminous indicator.
- Overheating protection.
- Easy to transport thanks to your lateral handles.
- 6 non -slip and resistant feet to maintain the establishment.

Ollas calentadoras

INOX 18/10  

- Mantiene caliente todo tipo de sopas, salsas, consomés y líquidos.
- Ideal para cantidades grandes.

- Il maintient toutes sortes de soupes, sauces, consommées et liquides chaudes.
- Idéal pour de grandes quantités.

- It keeps all kinds of soups, sauces, consomme and liquids hot.
- Ideal for large amounts.



Olla calentadora sopa Profesional

Marmite Buffet chaud · Suppen-und Speisenwärmer
Soup kettle · Panela aquecedora de sopa

| | Ref | € | W | Temperatura | Capacidad | Medidas | U.Venta |
|----------|-------|--------|-------------|-------------|-----------|---------------|---------|
| A | 69267 | 297,80 | 800 W | 30°C-90°C | 10L | Ø33x32 cm | 1 |
| B | 69037 | 178,70 | 400 - 475 W | 30°C-90°C | 11L | Ø34,5 x 36 cm | 1 |
| C | 69038 | 251,90 | 400 - 475 W | 30°C-90°C | 10L | Ø34,5x36 cm | 1 |

Repuesto recipiente (69037-69038)

Récipient de rechange (69037-69038) · Ersatzbehälter (69037-69038)
Spare container (69037-69038) · Recipiente de reserva (69037-69038)

| Ref | € | L | U.Venta |
|-------|-------|----|---------|
| 69039 | 59,70 | 10 | 1 |



Dispensadores y servidores



CRO
Cromado
Chrome



INOX
18/10

Servidor de zumos cromado

Distributeur de jus en inox · Saftbehälter mit rostfreiem Fuss
Juice dispenser mirror stand · Distribuidor de zumos pé cromado

| Ref | € | L | U.Venta |
|--------|---------------|------|---------|
| 69027 | 340,90 | 8,70 | 1 |
| R69027 | 97,50 | 8,70 | 1 |
| R69018 | 29,60 | - | 1 |

A Contenedor · Container
B Grifo · Tap

Boca ancha para cubitos hielo
Wide mouth for ice cubes

Doble pared
Double wall



INOX

Air Pot

Air pot · Getränkespender, isoliert
Air pot · Air pot

| Ref | € | L | h (cm) | U.Venta |
|-------|---------------|------|--------|---------|
| 62472 | 71,50 | 2,50 | 32,5 | 1 |
| 62473 | 77,60 | 3,00 | 34,5 | 1 |
| 62475 | 104,00 | 4,00 | 39,0 | 1 |

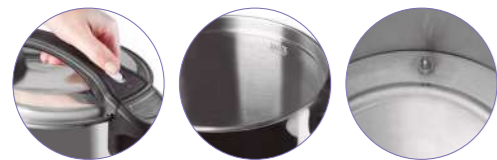

Fácil apertura. Marcas de llenado
Sensor de temperatura

Easy open system. Fill lines. Temperature sensor

INOX

Airpot eléctrico termosificador

Électrique Airpot · Elektrische Getränkenpender
Electric Airpot · Airpot eléctrico

| Ref | € | W | Capacidad | Temperatura | Medidas | U.Venta |
|-------|---------------|------|-----------|-------------|-------------|---------|
| 69472 | 134,60 | 1500 | 4L | 60°C-100°C | 28x28x35 cm | 1 |
| 69476 | 145,50 | 1500 | 6L | 60°C-100°C | 28x28x40 cm | 1 |
| 69471 | 158,80 | 1500 | 10L | 60°C-100°C | 28x28x48 cm | 1 |



Calentador de líquidos para buffet

Chauffe-café · Getränkebehälter
Coffee urn · Aquecedor de líquidos

| Ref | € | L | U.Venta |
|--------|---------------|-------|---------|
| 69028 | 382,90 | 11,00 | 1 |
| R69018 | 29,60 | - | 1 |

Grifo · Tap



NO UTILIZAR CON BEBIDAS GASEOSAS, CALDOS NI LÁCTEOS

DO NOT USE WITH FIZZY DRINKS, BROTHS OR DAIRY



- Mantiene las bebidas calientes o frías durante 24 horas.
- Doble pared que proporciona un alto rendimiento térmico.
- Ligero e irrompible.
- Boca ancha para cubos de hielo.
- Fácil de abrir y cerrar. Fácil limpieza.

- Gardez les boissons chaudes ou froides pendant 24 heures.
- Double paroi qui offre des performances thermiques élevées.
- Léger et incassable.
- Bouche large pour les glaçons.
- Facile à ouvrir et à fermer. Nettoyage facile.

- Keep hot or cold drinks for 24 hours.
- Double wall that provides high thermal performance.
- Light and unbreakable.
- Wide mouth for ice cubes.
- Easy to open and close. Easy cleaning.

NO UTILIZAR CON BEBIDAS GASEOSAS, CALDOS NI LÁCTEOS

DO NOT USE WITH FIZZY DRINKS, BROTHS OR DAIRY

- Fabricado en acero inoxidable resistente y de alta calidad.
- Calienta y mantiene el agua a una temperatura óptima.
- Dispone de un grifo dispensador con indicador de nivel de líquido.
- Temperatura controlada por termostato con un rango de 60°C a 100°C. Sensor de temperatura en el interior.
- Dispone de asas laterales aislantes del calor para un desplazamiento seguro.
- Fácil sistema de apertura y nivel de indicador de líquido. Con marcas de llenado en su interior.
- Sistema de dispensado cómodo y bandeja de goteo.
- Nota: utilizar solamente con agua.

- Heat and keep the water at an optimal temperature.
- It has a dispenser tap with liquid level indicator.
- Thermostat controlled temperature with a range of 60°C to 100°C. Temperature sensor inside.
- It has heat-insulating side handles for safe displacement.
- Easy opening system and liquid indicator level. With filling marks inside.
- Comfortable dispensing system and drip tray.
- Note: Use only with water.

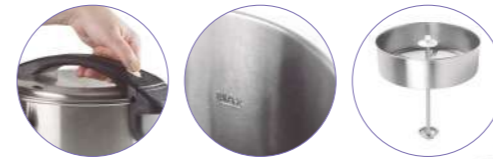

Fácil apertura. Marcas de llenado
Filtro microperforado
Easy open system · Fill lines
Micro-perforated filter

INOX



Cafetera percoladora

Percolateur à café · Kaffee-Perkolator
Coffee percolator · Máquina/Percolador de café

| Ref | € | W | Capacidad | Medidas | U.Venta |
|-------|---------------|------|-----------|-------------|---------|
| 69486 | 167,30 | 1500 | 6L | 28x28x40 cm | 1 |
| 69481 | 186,70 | 1500 | 10L | 35x35x45 cm | 1 |



INOX
18/10



Dishwasher

Dispensador de leche

Dispensateur de lait · Milchkanne mit Fuß
Milk dispenser with base · Distribuidor de leite

| Ref | € | L | Medidas | U.Venta |
|-------|---------------|-----|-------------|---------|
| 69030 | 423,60 | 5,5 | 22x33x44 cm | 1 |

Grifo dispensador
Dispensing tap



- Permite su uso para calentamiento como para refrigeración.
- Il permet son utilisation pour le chauffage comme pour la réfrigération.
- It allows its use for heating as for refrigeration.



ASA
Acrylic



Dishwasher

Organizador de café

Organisateur de café · Kaffee Veranstalter
Coffee organizer · Organizador de café

| Ref | € | cm | h(cm) | U.Venta |
|----------------|--------------|-----------|-------|---------|
| A 62280 | 10,70 | 11,5x11,5 | 20 | 1 |
| B 62281 | 38,90 | 35,5x26,5 | 18 | 1 |
| C 62283 | 71,00 | 35,5x26,5 | 31 | 1 |

- Soporte organizador para tazas de café, vasos desechables y papel, servilletas, cápsulas de café, azúcar, infusiones, cucharas, etc.
- Fabricado en plástico ABS.
- 4 compartimentos.
- Ideal para mantener todo organizado y presentado de forma atractiva.
- Ideal para cafeterías.
- La referencia 62280 encaja perfectamente sobre la base.
- Fácil limpieza. Apto para el lavavajillas.
- Base muy estable.

- Organizing support for coffee cups, disposable vessels and paper, napkins, coffee capsules, sugar, infusions, spoons, etc.
- Made of ABS plastic.
- 4 compartments.
- Ideal to maintain everything organized and presented in an attractive way.
- Ideal for coffee shops.
- Reference 62280 fits perfectly on the base.
- Easy cleaning. Apt for the dishwasher.
- Very stable base.



ABS Plastic PS Plastic Dishwasher BPA free



Sistema dispensador giratorio
Rotating dispensing system

Base ancha; ofrece una mayor estabilidad
Wide base for greater stability



Tapa hermética
Lid hermetic

Sistema dispensador giratorio
Rotating dispensing system

Base ancha; ofrece una mayor estabilidad
Wide base for greater stability

Dispensador de cereales Flor

Distributeur de céréales · Cerealienspender
Cereal dispenser · Dispensador de cereais

| Ref | € | cm | h(cm) | L | U.Venta |
|-------|-------|-------|-------|------|---------|
| 62545 | 24,70 | 16x20 | 40 | 3,50 | 1 |

Dispensador de cereales Dual

Distributeur de céréales · Frühstücksflocken Spender
Cereal dispenser · Dispensador de cereais

| Ref | € | L | U.Venta |
|-------|-------|---------|---------|
| 62596 | 29,70 | 2 x 2 | 1 |
| 62597 | 38,20 | 3,5 x 2 | 1 |



Tapa hermética
Lid hermetic

Anclaje en pared
Wall anchor

Sistema dispensador giratorio
Rotating dispensing system

Conserva la frescura y el sabor de los alimentos por más tiempo
Preserves the freshness and taste of food for longer



Dispensador de cereales de pared Flor

Distributeur de céréales mural · Wandspender für Cerealien
Wall-mounted cereal dispenser · Dispensador de cereais de parede

| Ref | € | cm | h(cm) | L | U.Venta |
|---------|-------|-----------|-------|----------|---------|
| A 62541 | 16,90 | 14,5x12,5 | 31 | 1,50 | 1 |
| B 62542 | 28,10 | 28x12,5 | 31 | 1,50 x 2 | 1 |

Simple · Simple
Doble · Double

INOX 18/10 Dishwasher

Dispensador de cereales Inox 18/10

Distributeur de Cereales sur Pied · Cerialenspender mit Fuss
Cereal Dispenser with Stand · Distribuidor de cereis com base

| Ref | € | Ø (cm) | cm | L | U.Venta |
|---------|--------|--------|----------|------|---------|
| A 69022 | 302,30 | 18,5 | 24x34x70 | 10,0 | 1 |
| B 69023 | 598,70 | 18,5 | 44x34x70 | 10,0 | 1 |

Simple · Simple
Doble · Double



Cubetas y cacerolas Inducción

new

INOX 18/10 Sandwich Induction Vitro Electric Gas Oven Dishwasher

- Fabricada en acero inoxidable 18/10 de gran calidad.
- Fondo difusor, compatible con todas las fuentes de calor (incluida la inducción y el horno).
- Distribución rápida y uniforme del calor.
- Recubrimiento interior antiadherente QuanTanium® reforzado con partículas de titanio; libre de materiales tóxicos y pesados, ecológico y libre de PFOA.

- Fabriqué en acier inoxydable 18/10 de haute qualité.
- Fond diffuseur, compatible avec toutes les sources de chaleur (y compris l'induction et le four).
- Diffusion rapide et uniforme de la chaleur.
- Revêtement intérieur antiadhésif QuanTanium® renforcé par des particules de titane; exempt de matériaux toxiques et lourds, respectueux de l'environnement et sans PFOA.

- Made of high quality 18/10 stainless steel.
- Diffuser bottom, compatible with all heat sources (including induction and oven).
- Fast and even heat distribution.
- Non-stick QuanTanium® inner coating reinforced with titanium particles; free of toxic and heavy materials, environmentally friendly and PFOA-free.

Fondo difusor - Diffuser bottom

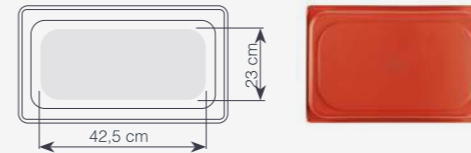

Antiadherente interior - Non-stick interior



Cubetas Inducción

Batterie de cuisine à induction · Induktionskochgeschirr
Induction Cookware · Utensílios de cozinha de indução

| Ref | € | cm | h(cm) | L | e (mm) | U.Venta |
|---------|-------|------------------|-------|-----|--------|---------|
| A 15365 | 95,90 | 53x32,5 (GN 1/1) | 6,5 | 8,3 | 0,7 | 1 |
| B 15465 | 95,90 | 53x32,5 (GN 1/1) | 6,5 | 8,3 | 0,7 | 1 |
| C 15565 | 95,90 | 53x32,5 (GN 1/1) | 6,5 | 8,3 | 0,7 | 1 |

Dishwasher



Cacerola con tapa Red

Faitout avec couvercle · Bratentopf mit Deckel
Casserole with lid · Caçarola com tampa

Cacerola con tapa White

Faitout avec couvercle · Bratentopf mit Deckel
Casserole with lid · Caçarola com tampa

Cacerola con tapa Ocean

Faitout avec couvercle · Bratentopf mit Deckel
Casserole with lid · Caçarola com tampa

| Ref | € | Ø (cm) | h(cm) | L | U. Venta | Ref | € | Ø (cm) | h(cm) | L | U. Venta | Ref | € | Ø (cm) | h(cm) | L | U. Venta |
|-------|-------|--------|-------|------|----------|-------|-------|--------|-------|------|----------|-------|-------|--------|-------|------|----------|
| 15316 | 40,90 | 16 | 8,0 | 1,50 | 1 | 15416 | 40,90 | 16 | 8,0 | 1,50 | 1 | 15516 | 40,90 | 16 | 8,0 | 1,50 | 1 |
| 15320 | 48,80 | 20 | 10,0 | 3,00 | 1 | 15420 | 48,80 | 20 | 10,0 | 3,00 | 1 | 15520 | 48,90 | 20 | 10,0 | 3,00 | 1 |
| 15324 | 59,10 | 24 | 12,0 | 5,00 | 1 | 15424 | 59,20 | 24 | 12,0 | 5,00 | 1 | 15524 | 59,10 | 24 | 12,0 | 5,00 | 1 |

Tapa

Couvercle · Deckel
Lid · Tampa

| Ref | € | Ø (cm) | U.Venta |
|-------|-------|--------|---------|
| 15306 | 9,40 | 16 | 1 |
| 15302 | 10,40 | 20 | 1 |
| 15304 | 11,10 | 24 | 1 |



Diseñada para colocar en el borde de la cacerola
Designed to fit on the rim of the pan



Bandejas y Buffet Pizarra



- Fabricada en pizarra 100% natural con amplia superficie de apoyo de Ø35 cm.
- Soporte giratorio de cristal y pie de acero inoxidable, permite una rotación fácil y suave en ambos sentidos.
- Diseñado para presentar y servir tapas, aperitivos, postres, etc.
- Fácil limpieza. No es apta para el lavavajillas.

- Made of 100% natural slate and featuring a large Ø 35 cm support surface.
- Revolving glass dish and stainless steel base for easy, smooth rotation in both directions.
- Designed to present and serve snacks, dips, appetisers, desserts, etc.
- Easy to clean. Not dishwasher safe.



Plato giratorio pizarra natural

Plateau tournant en ardoise naturelle · Drehteller aus Naturschiefer
Rotating serving dish in natural slate · Prato giratório em ardósia natural

| Ref | € | Ø (cm) | h(cm) | U.Venta |
|-------|-------|--------|-------|---------|
| 61235 | 20,40 | 35 | 2,5 | 1 |

Soporte expositor pizarra

Présentoir · Schieferständer
Display stand · Expositor

| Ref | € | Grande cm | Pequeña cm | h(cm) | U.Venta |
|-------|------|-----------|------------|-------|---------|
| 61234 | 8,00 | 20 | 15 | 34 | 1 |

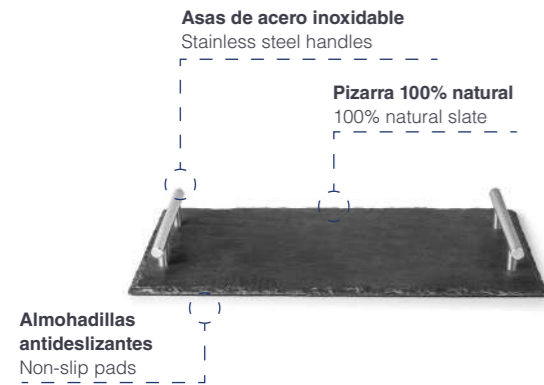

Bandeja pizarra con asas

plateau en ardoise avec poignées · Schiefertablett mit Griffen
Slate tray with handles · Bandeja de ardósia com asas

| Ref | € | cm | h(cm) | U.Venta |
|-------|-------|---------|-------|---------|
| 61230 | 11,50 | 40x20 | 5,0 | 1 |
| 61231 | 16,60 | 45,5x30 | 5,0 | 1 |
| 61232 | 18,70 | 53x5x33 | 5,0 | 1 |

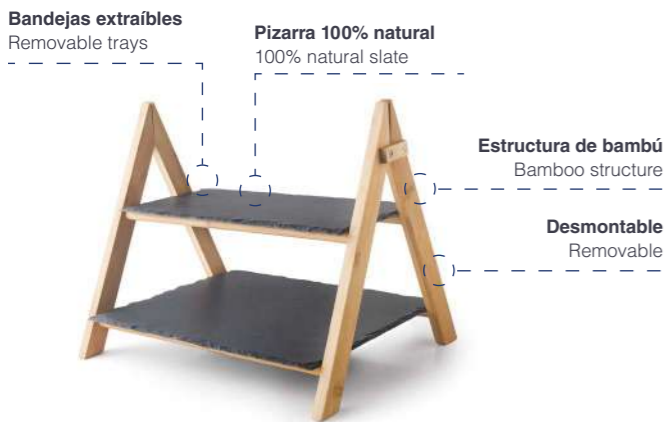

Soporte expositor pizarra

Présentoir · Schieferständer
Display stand · Expositor

| Ref | € | Grande cm | Pequeña cm | h(cm) | U.Venta |
|-------|-------|-----------|------------|-------|---------|
| 61233 | 21,10 | 35x25 | 35x15 | 22 | 1 |



Vajilla catering Degustare



- Vajilla para catering moderna, innovadora y atractiva.
- Ideal para cualquier tipo de celebración como banquetes, bodas, fiestas, etc. Realizan cualquier tipo de catering de alta gama.
- Permite múltiples combinaciones gracias a la variedad de formas.
- Reutilizables e irrompibles. Manejables y ligeros para su transporte.
- 100% apilables.

- Vaisselle pour buffets moderne, innovante et attractive.
- Idéale pour tout type de célébration comme des banquets, mariages, fêtes, etc. Elle sublime tout type de buffet haut de gamme.
- Permet de multiples combinaisons grâce à la variété des formes.
- Pièces réutilisables et incassables. Maniables et légères pour le transport.
- 100% empilable.

- Modern, innovative and attractive catering dinnerware.
- Ideal for any type of celebration, such as banquets, weddings, parties etc. Enhances any kind of high-end catering.
- Perfect for multiple combinations due to the variety of different shapes.
- Reusable and unbreakable.
- Handy and lightweight for transport.
- 100% stackable.

Bandeja Degustare

Vaisselle pour la restauration · Catering-Geschirr
Catering dinnerware · Serviço de catering

| Ref | € | cm | h(cm) | U.Venta |
|-------|-------|---------|-------|---------|
| 60750 | 11,60 | 42x28,5 | 2,5 | 1 |



Degustare White

Vaisselle pour la restauration · Catering-Geschirr
Catering dinnerware · Serviço de catering

| | Ref | € | cm | h(cm) | ml | U.Venta |
|---|-------|-------|---------|-------|-----|---------|
| A | 60751 | 7,80 | Ø8,5 | 5,5 | 115 | 1 |
| B | 60752 | 8,00 | 8,5x8,5 | 5,5 | 80 | 1 |
| C | 60753 | 8,10 | Ø8,0 | 4,0 | 100 | 1 |
| D | 60754 | 8,00 | 13x6,5 | 3,5 | 35 | 1 |
| E | 60755 | 7,50 | Ø6,0 | 7,5 | 65 | 1 |
| F | 60756 | 9,00 | 9,5x7,5 | 5,00 | 140 | 1 |
| G | 60757 | 12,60 | Ø7,5 | 7,00 | 80 | 1 |

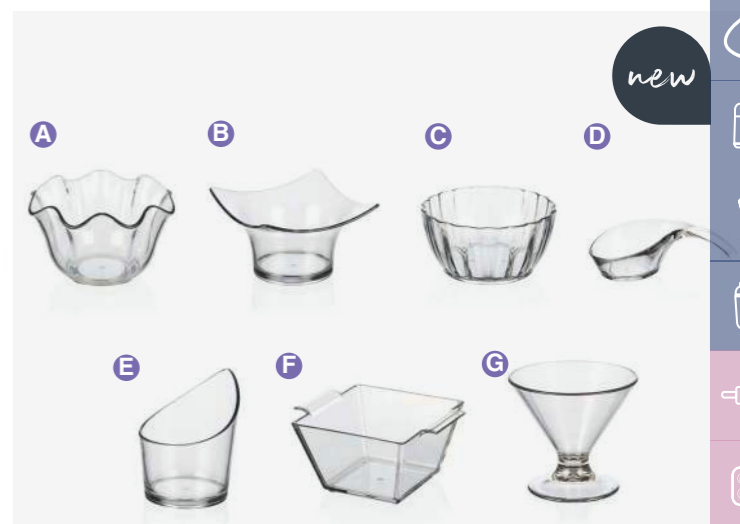

Degustare Transparent

Fleur bol · Flower bowl
Bolforn Blume · Bacia flor

| | Ref | € | cm | h (cm) | ml | U.Venta |
|---|-------|-------|---------|--------|-----|---------|
| A | 60781 | 8,50 | Ø8,5 | 5,5 | 115 | 1 |
| B | 60782 | 8,60 | 8,5x8,5 | 5,5 | 80 | 1 |
| C | 60783 | 8,90 | Ø8,0 | 4,0 | 100 | 1 |
| D | 60784 | 8,70 | 13x6,5 | 3,5 | 35 | 1 |
| E | 60785 | 8,10 | Ø6,0 | 7,5 | 65 | 1 |
| F | 60786 | 9,10 | 9,5x7,5 | 5,00 | 140 | 1 |
| G | 60787 | 12,60 | 7,5x7,5 | 7,00 | 80 | 1 |



Buffet & Display Melamina mármol



- Fabricados en melamina de alta calidad.
- Aspecto elegante efecto mármol.
- Diseñados para presentar todo tipo de alimentos tanto fríos como calientes (70°C / -20°C).
- Ideales para exponer en todo tipo de buffet, caterings, etc.
- 100% apilables.
- Prácticos y atractivos. Presentan una funcionalidad y durabilidad inmejorables.
- Fácil limpieza: aptas para el lavavajillas.
- Libres de BPA.

- Fabriqué en mélamine de haute qualité.
- Élégant aspect marbré.
- Conçu pour présenter tous types d'aliments, aussi bien chauds que froids (70°C / -20°C).
- Idéal pour la présentation dans tous les types de buffets, traiteurs, etc.
- 100 % empilables.
- Pratiques et attrayants. Fonctionnalité et durabilité imbattables.
- Facile à nettoyer : apte au lave-vaisselle.
- Sans BPA.

- Made of high quality melamine.
- Elegant marble appearance.
- Designed for presenting all kinds of food, both cold and hot (70°C / -20°C).
- Perfect for displaying in all kinds of buffets, catering, etc.
- 100% stackable.
- Practical and attractive. Unbeatable functionality and durability.
- Easy to Clean: dishwasher safe.
- BPA free.

Infinidad de combinaciones posibles · Endless possible combinations

BAJOS · LOW



ALTOS · HIGH

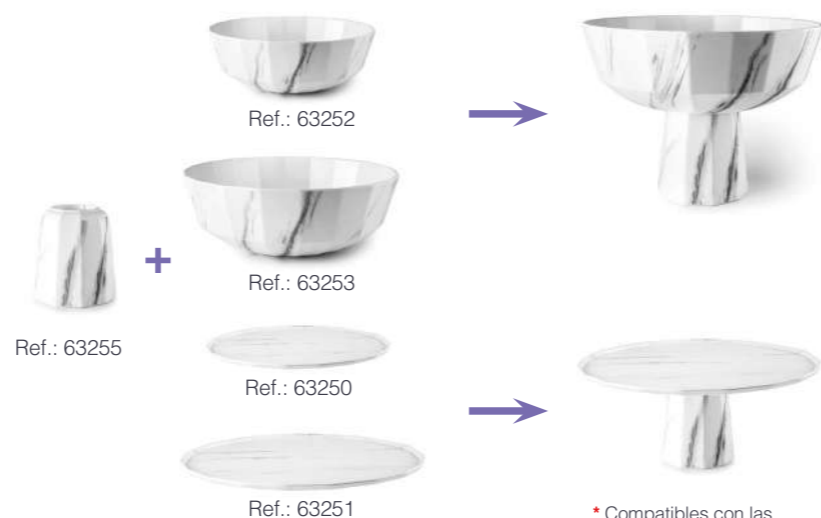

* Compatibles con las campanas PS (Ref.: 61801-61803)



Frutero

Corbeille à fruits · Obstschüssel
Fruit basket · Fruteiro

| Ref | € | Ø (cm) | h(cm) | L | U.Venta |
|-------|-------|--------|-------|------|---------|
| 63252 | 29,70 | 21,3 | 7,5 | 1,5 | 1 |
| 63253 | 50,10 | 28,5 | 10,0 | 3,80 | 1 |



Portatartas

Porte-gâteau · Tortenständer
Cake stand · Suporte de bolos

| Ref | € | Ø (cm) | h(cm) | U.Venta |
|-------|-------|--------|-------|---------|
| 63250 | 23,00 | 22,5 | 2,0 | 1 |
| 63251 | 37,20 | 33,0 | 2,0 | 1 |

Soporte

Support · Stand
Stand · Suporte

| Ref | € | Ø (cm) | h(cm) | L | U.Venta |
|-------|-------|--------|-------|------|---------|
| 63254 | 9,40 | 11,5 | 8,5 | 0,44 | 1 |
| 63255 | 11,20 | 11,5 | 12,0 | 0,71 | 1 |



Multifunción.
Soporte + vaso
para servir aperitivos
Multi-purpose.
Stand + glass for serving
aperitifs



Bandeja

Plateau · Tablett
Tray · Bandeja

| Ref | € | cm | U.Venta |
|-------|-------|--------------------|---------|
| 63242 | 28,10 | 26,5x32,5 (GN 1/2) | 1 |
| 63243 | 30,10 | 53x16,5 (GN 2/4) | 1 |
| 63244 | 55,20 | 53x65 (GN 1/1) | 1 |

- Fabricadas en melamina de alta calidad. Libres de BPA
- Aspecto elegante efecto mármol.
- Diseñadas para presentar todo tipo de alimentos tanto fríos como calientes (70 / -20°C)
- Ideales para exponer en todo tipo de buffet, caterings, etc.
- 100% apilables.
- Fácil limpieza: aptas para el lavavajillas.

- Fabriqué en mélamine de haute qualité. Sans BPA
- Élégant aspect marbré.
- Conçu pour présenter tous types d'aliments, aussi bien chauds que froids (70 / -20°C).
- Idéal pour la présentation dans tous les types de buffets, traiteurs, etc.
- 100% empilables.
- Facile à nettoyer : passe au lave-vaisselle.

- Made of high quality melamine. BPA free
- Elegant marble effect appearance.
- Designed to present all types of food, both hot and cold (70 / -20°C).
- Ideal for displaying in all types of buffets, caterings, etc.
- 100% stackable.
- Easy to clean: dishwasher safe.



VIDRIO
Glass
Microwave Oven Freezer

Campana cubreplatos

Cloche couvre plat · Tellerglocke
Plate Cover · Campânula cobre-pratos

| Ref | € | Ø (cm) | h(cm) | U.Venta |
|-------|-------|--------|-------|---------|
| 61801 | 6,70 | 22,0 | 12,0 | 1 |
| 61803 | 12,40 | 30,0 | 15,5 | 1 |

| Ref | € | Ø (cm) | h(cm) | U.Venta |
|-------|-------|--------|-------|---------|
| 61806 | 40,50 | 25 | 18,5 | 1 |
| 61809 | 46,30 | 29 | 20,3 | 1 |
| 61802 | 50,10 | 33 | 22,3 | 1 |

Colección Nord Buffet

new

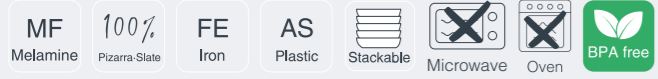

- Una colección moderna diseñada para buffet que incluye soportes, cajas y bandejas.
- Combina materiales de alta calidad como la acacia, la pizarra, la melamina y el hierro.
- Cajas y bandejas apilables fabricadas en medidas gastronorm.
- Su sistema modular permite realizar presentaciones únicas.
- Su diseño facilita la creación de diversas combinaciones, con la posibilidad de ampliarlas según lo exija cada ocasión.
- Compacta y funcional, optimiza el espacio mientras asegura una presentación atractiva y elegante.
- Todos los componentes de madera están tratados para resistir la humedad siendo aptos para el contacto con alimentos.

- Une collection moderne conçue pour les buffets, comprenant des stands, des boîtes et des plateaux.
- Elle combine des matériaux de haute qualité tels que l'acacia, l'ardoise, la mélamine et le fer.
- Boîtes et plateaux empilables en format gastronomique.
- Son système modulaire permet des présentations uniques.
- Sa conception facilite la création de diverses combinaisons, avec la possibilité de les étendre selon les besoins de chaque occasion.
- Compact et fonctionnel, il optimise l'espace tout en assurant une présentation attrayante et élégante.
- Tous les éléments en bois sont traités pour résister à l'humidité et sont adaptés au contact avec les aliments.

- A modern collection designed for buffets including stands, boxes and trays.
- It combines high quality materials such as acacia, slate, melamine and iron.
- Stackable boxes and trays made in gastronorm sizes.
- Its modular system allows for unique presentations.
- Its design facilitates the creation of various combinations, with the possibility of expanding them as required for each occasion.
- Compact and functional, it optimises space while ensuring an attractive and elegant presentation.
- All wooden components are treated to resist humidity and are suitable for contact with food.



Caja GN 1/1
Boîte · Box
Box · Caixa

| Ref | € | Medidas | h (cm) | U.Venta |
|-------|-------|--------------------|--------|---------|
| 67914 | 25,40 | 53x32,5cm (GN1/1) | 4,5 | 1 |
| 67918 | 29,20 | 53x32,5cm (GN1/1) | 8,5 | 1 |
| 67916 | 39,90 | 53x32,5cm (GN1/1) | 16,5 | 1 |



Caja GN 1/2
Boîte · Box
Box · Caixa

| Ref | € | Medidas | h (cm) | U.Venta |
|-------|-------|-----------------------|--------|---------|
| 67924 | 16,90 | 26,5x32,5cm (GN 1/2) | 4,5 | 1 |
| 67928 | 20,50 | 26,5x32,5cm (GN 1/2) | 8,5 | 1 |
| 67926 | 24,70 | 26,5x32,5cm (GN 1/2) | 16,5 | 1 |



Caja GN 1/3
Boîte · Box
Box · Caixa

| Ref | € | Medidas | h (cm) | U.Venta |
|-------|-------|----------------------|--------|---------|
| 67934 | 14,50 | 32,5x17x6cm (GN 1/3) | 4,5 | 1 |
| 67938 | 17,60 | 32,5x17x6cm (GN 1/3) | 8,5 | 1 |



Caja GN 2/4
Boîte · Box
Box · Caixa

| Ref | € | Medidas | h (cm) | U.Venta |
|-------|-------|--------------------|--------|---------|
| 67944 | 17,60 | 53x16,2cm (GN 2/4) | 4,5 | 1 |
| 67948 | 21,90 | 53x16,2cm (GN 2/4) | 8,5 | 1 |



Soporte recto
Support droit · Gerade Stütze
Straight support · Suporte reto

| Ref | € | cm | U.Venta |
|-------|-------|--------------------|---------|
| 67920 | 22,90 | 32,5x26,5 (GN 1/2) | 1 |
| 67910 | 28,00 | 53x32,5 (GN 1/1) | 1 |



Soporte Inclinado
Support incliné · Gekippte Stütze
Tilted support · Suporte inclinado

| Ref | € | cm | U.Venta |
|-------|-------|--------------------|---------|
| 67921 | 22,90 | 32,5x26,5 (GN 1/2) | 1 |
| 67911 | 28,00 | 53x32,5 (GN 1/1) | 1 |



Bandeja room service
Plateau de service en chambre · Zimmerservice-Tablett
Room Service Tray · Bandeja de serviço de quarto

| Ref | € | cm | h (cm) | U.Venta |
|-------|-------|-------|--------|---------|
| 67953 | 28,30 | 45x35 | 6 | 1 |



Caja Cubiertos GN 1/1
Couverts de table · Schachtel-Besteck
Box Cutlery · Talheres de caixa

| Ref | € | cm | U.Venta |
|-------|-------|------------------|---------|
| 67951 | 40,70 | 53x32,5 (GN 1/1) | 1 |



Cubertero
Plateau à couverts · Besteckkasten
Cutlery tray · Tabuleiro de talheres

| Ref | € | cm | h (cm) | U.Venta |
|-------|-------|-------|--------|---------|
| 67952 | 24,70 | 15x22 | 11 | 1 |

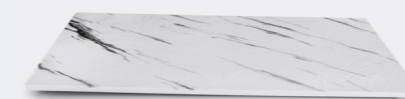

Bandeja mármol white melamina
Plateau en marbre mélaminé blanc
Marmortablett weißes Melamin
White melamine marble tray
Tabuleiro de mármore em melamina

| Ref | € | cm | U.Venta |
|-------|-------|--------------------|---------|
| 63076 | 21,20 | 32,5x17,5 (GN 1/3) | 1 |
| 63077 | 34,90 | 32,5x26,5 (GN 1/2) | 1 |
| 63079 | 31,20 | 53x16,5 (GN 2/4) | 1 |
| 63078 | 67,60 | 53x32,5 (GN 1/1) | 1 |



Bandeja mármol black melamina
Plateau en mélamine noire
Schwarzes Melamin-Marmortablett
Black melamine marble tray
Tabuleiro de mármore em melamina

| Ref | € | cm | U.Venta |
|-------|-------|--------------------|---------|
| 63096 | 21,20 | 32,5x17,6 (GN 1/3) | 1 |
| 63097 | 34,90 | 32,5x26,5 (GN 1/2) | 1 |
| 63099 | 31,20 | 53x16,5 (GN 2/4) | 1 |
| 63098 | 67,60 | 53x32,5 (GN 1/1) | 1 |



Bandeja pizarra
Plateau en ardoise
Schiefertablett
Slate tray
Bandeja de ardósia

| Ref | € | cm | U.Venta |
|-------|-------|--------------------|---------|
| 61223 | 4,60 | 32,5x17,6 (GN 1/3) | 1 |
| 61222 | 6,90 | 32,5x26,5 (GN 1/2) | 1 |
| 61224 | 7,80 | 53x16,5 (GN 2/4) | 1 |
| 61221 | 15,60 | 53x32,5 (GN 1/1) | 1 |

Cuberteros

INOX
Dishwasher



Vaso inox cubertería

Panier pour porte couvert · Besteckköcher
St. steel cutlery cylinder · Copos p/talheres inox



| Ref | € | h(cm) | U.Venta |
|-------|------|-------|---------|
| 33125 | 7,80 | 14 | 6 |

- Ideal para organizar y guardar los cubiertos y utensilios de la cocina.
- No se deforma con el peso de los cubiertos.
- Cómodo de transportar gracias a sus asas laterales.
- Apilable.

- Ideal to organize and save the cutlery and kitchen utensils.
- It does not deform with the weight of the cutlery.
- Comfortable to transport thanks to your lateral handles.
- Stackable.



PP
Polypropylene



Cubertero GN 1/2

Range-couverts · Besteckkasten
Cutlery holder · Bandeja para talheres

| Ref | € | cm | h(cm) | U.Venta |
|-------|-------|---------|-------|---------|
| 33121 | 11,50 | 52,5x32 | 9,5 | 1 |

A



B



C



- Recipiente para cubiertos en color negro de polipropileno.
- Ideal para organizar y guardar los cubiertos y utensilios de la cocina.
- Apilable.
- Récipient de couverts en polypropylène noir.
- Idéal pour organiser et sauver les couverts et les ustensiles de cuisine.
- Empilable.
- Black polypropylene cutlery container.
- Ideal to organize and save the cutlery and kitchen utensils.
- Stackable.

PP
Polypropylene



Cubertero Ratán

Range-couverts · Besteckkasten
Cutlery holder · Bandeja para talheres

| Ref | € | cm | h(cm) | Compartimentos | U.Venta | |
|-----|-------|-------|---------|----------------|---------|---|
| A | 63484 | 8,60 | 27x10 | 4,5 | 1 | 1 |
| B | 63485 | 8,60 | Ø12 | 15,0 | 1 | 1 |
| C | 63491 | 76,80 | 53x32,5 | 9,0 | 4 | 1 |

Paneras y Fruteros

INOX



Frutero - Panera inox

Paniere à fruit et à pain · Brot-/Obstschale
Fruits and bread basket · Fruteiro-Cesto

| Ref | € | Ø (cm) | U.Venta |
|-------|-------|--------|---------|
| 61821 | 7,70 | 20 | 1 |
| 61823 | 11,60 | 24 | 1 |

A

B

C

D



Panera kraft

Boîte à pain · Brotkasten
Bread basket · Caixa para guardar pão

| Ref | € | cm | h max (cm) | h min (cm) | U.Venta | |
|-----|-------|-------|------------|------------|---------|---|
| A | 63476 | 13,80 | 10x10 | 25 | 8 | 1 |
| B | 63477 | 14,70 | 12x12 | 25 | 12 | 1 |
| C | 63478 | 16,60 | 15x15 | 25 | 12 | 1 |
| D | 63479 | 19,20 | 20x20 | 33 | 12 | 1 |

A

B

C

D



Panera Tex

Boîte à pain · Brotkasten
Bread basket · Caixa para guardar pão

| Ref | € | cm | h max (cm) | h min (cm) | U.Venta | |
|-----|-------|-------|------------|------------|---------|---|
| A | 63486 | 13,80 | 10x10 | 25 | 8 | 1 |
| B | 63487 | 14,70 | 12x12 | 25 | 12 | 1 |
| C | 63488 | 16,60 | 15x15 | 25 | 12 | 1 |
| D | 63489 | 19,20 | 20x20 | 33 | 12 | 1 |



- Tapa fabricada en madera de caucho con orificios de ventilación para una óptima circulación del aire.
- 2 en 1: la tapa de madera de caucho se puede utilizar como tabla de cortar.

- Cover made of rubber wood with ventilation holes for optimal air circulation.
- Designed to conserve bread and other always fresh products.
- 2 in 1: The rubber wood lid can be used as a cutting table.

A



B



RUBBER WOOD

Panera nórdica

Boîte à pain · Brotkasten
Bread basket · Caixa para guardar pão

| Ref | € | cm | h(cm) | U.Venta | |
|-----|-------|-------|---------|---------|---|
| A | 62868 | 39,60 | 30x18 | 12,5 | 1 |
| B | 62869 | 43,00 | 42x22,5 | 12,5 | 1 |



- Fabricada en fibra virgen natural.
- Material ecológico y respetuoso con el medio ambiente.
- Lavable, resistente y duradera.
- Diseñada y fabricada en España.
- Hecha a mano.
- Tacto agradable y suave, similar a la piel. Espesor 0,55 mm.

- Fabriqué en fibre vierge naturelle.
- Matériel écologique et environnemental.
- Lavable, résistant et durable.
- Conçu et fabriqué en Espagne.
- Fait main.
- Un toucher agréable et doux, similaire à la peau. 0,55 mm d'épaisseur.

- Manufactured in natural virgin fiber.
- Ecological and environmental material.
- Washable, resistant and lasting.
- Designed and manufactured in Spain.
- Handmade.
- Nice and soft touch, similar to the skin. 0.55 mm thickness.



Estructura de refuerzo de acero inoxidable
Stainless steel reinforcement structure

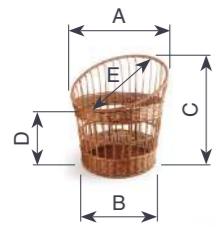

- Cesta para pan fabricada en polipropileno. Diseñada para uso intensivo.
- Estructura de refuerzo de acero inoxidable. Parte trasera más alta que proporciona suficiente apoyo para panes largos.
- Material con aspecto de mimbre muy resistente, libre de BPA.
- Elaborada a mano. Práctica e higiénica. Acabado en mate.
- Ideal para almacenar y exponer panes.
- Apilable.

- Panier à pain fabriqué en polypropylène. Conçu pour une utilisation intensive.
- Structure d'armature en acier inoxydable. L'arrière le plus élevé qui fournit un soutien suicide aux pains longs.
- Matériau très résistant en osier, sans BPA.
- Fait main. Pratique et hygiénique. Finition mate.
- Idéal pour stocker et exposer le pain.
- Empilable.

- Bread basket manufactured in polypropylene. Designed for intensive use.
- Stainless steel reinforcement structure. Highest rear that provides suicide support for long breads.
- Very resistant wicker-like material, BPA free.
- Handmade. Practice and hygienic. Matte finish.
- Ideal to store and expose bread.
- Stackable.

Cesta baguette

Corbeille · Brotkorb
Basket · Cesta

| | Ref | € | A (cm) | B (cm) | C (cm) | D (cm) | E (cm) | U.Venta |
|----------|-------|-------|--------|--------|--------|--------|--------|---------|
| A | 63492 | 64,40 | 32,0 | 28,5 | 42,0 | 25,0 | 36,5 | 1 |
| B | 63493 | 64,40 | 32,0 | 28,5 | 42,0 | 25,0 | 36,5 | 1 |



Cesta de pan redonda

Corbeille a pain ronde · Brotkorb, rund
Round bread basket · Cesta de pão redonda

| | Ref | € | Ø (cm) | h(cm) | U.Venta |
|----------|-------|-------|--------|-------|---------|
| A | 63471 | 7,90 | 19 | 8 | 1 |
| | 63472 | 8,80 | 21 | 8 | 1 |
| | 63473 | 9,40 | 23 | 8 | 1 |
| | 63474 | 10,10 | 28 | 8 | 1 |
| B | 63871 | 8,00 | 19 | 8 | 1 |
| | 63872 | 8,80 | 21 | 8 | 1 |
| | 63873 | 9,40 | 23 | 8 | 1 |
| | 63874 | 10,20 | 26 | 8 | 1 |



Cesta de pan

Corbeille a pain · Brotkorb
Bread basket · Cesta de pão

| | Ref | € | Ø (cm) | h (cm) | U.Venta |
|----------|-------|-------|--------|--------|---------|
| A | 63494 | 30,80 | 35 | 20 | 1 |
| B | 63894 | 30,30 | 35 | 20 | 1 |

Cesta de pan oval

Corbeille a pain ovale · Brotkorb, Oval
Oval bread basket · Cesta de pão oval

| | Ref | € | cm | h(cm) | U.Venta |
|----------|-------|-------|-------|-------|---------|
| A | 63480 | 7,20 | 19x14 | 8,0 | 1 |
| | 63481 | 8,50 | 24x17 | 8,0 | 1 |
| | 63482 | 10,40 | 28x16 | 8,5 | 1 |
| B | 63880 | 7,20 | 19x14 | 8,0 | 1 |
| | 63881 | 8,40 | 24x17 | 8,0 | 1 |
| | 63882 | 10,40 | 28x16 | 8,5 | 1 |



Cesta de pan cuadrada

Corbeille a pain carré · Brotkorb, vierekigl
Square bread basket · Cesta de pão quadrada

| | Ref | € | cm | h (cm) | U.Venta |
|----------|-------|-------|---------|--------|---------|
| A | 63490 | 35,20 | 53x33,5 | 9 | 1 |
| B | 63890 | 34,90 | 53x33,5 | 9 | 1 |



- Diseño transpirable.
- Versátil: ideal para fruta, verdura, tarros de conservas, frutos secos, huevos, etc.

- The breathable,
- Versatile: perfect for fruit, vegetables, canning jars, etc.

Medidas · Sizes
19,5x17,5x7 cm

Medidas · Sizes
29x18x8 cm

FE
Iron

Frutero Dual SQ

Corbeille à fruits · Obstkorb
Fruit basket · Fruteira

| Ref | € | cm | h(cm) | U.Venta |
|-------|-------|---------|-------|---------|
| 61124 | 19,30 | 29x18,5 | 33,5 | 4 |

Madera contrachapada color haya
Plywood beech color

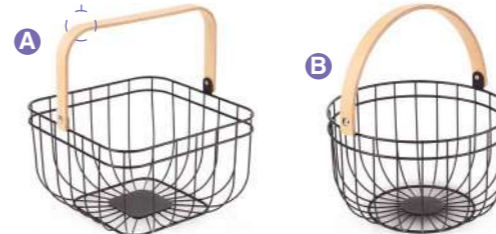

FE
Iron

Frutero varilla mango

Corbeille à fruits · Obstschale aus Gitterstäben
Square fruit bowl · Cesto de metal para fruta

| | Ref | € | h (cm) | Diámetro varilla (mm) | U.Venta |
|----------|-------|-------|--------|-----------------------|---------|
| A | 61137 | 35,30 | 28 | 4 | 1 |
| B | 61138 | 35,30 | 29 | 4 | 1 |

Ideales para almacenar fruta, pan, verduras, huevos, etc.
Can be used for storing fruit, bread, vegetables, eggs, etc.

FE
Iron

Frutero varillas

Corbeille à fruits · Obstschale aus Gitterstäben
Square fruit bowl · Cesto de metal para fruta

| | Ref | € | Ø (cm) | h (cm) | Diámetro varilla (mm) | U.Venta |
|----------|-------|-------|--------|--------|-----------------------|---------|
| A | 61126 | 23,50 | 23,5 | 25,5 | 4 | 2 |
| B | 61127 | 21,40 | 27,0 | 14,0 | 4 | 1 |
| C | 61128 | 22,60 | 34,0 | 9,5 | 4 | 1 |

Frutero varillas Dual

Corbeille à fruits · Obstschale aus Gitterstäben
Rod fruit bowl · Cesto de metal para fruta

| Ref | € | Diámetro varilla (mm) | Ø superior (cm) | Ø inferior (cm) | h(cm) | U.Venta |
|-------|-------|-----------------------|-----------------|-----------------|-------|---------|
| 61140 | 54,90 | 4 | Ø40x10 | Ø24x10 | 63 | 1 |



FE
Iron

Frutero varillas redondo bajo

Corbeille à fruits ronde basse · Obstschale aus Gitterstäben
Round low rod fruit bowl · Cesto de metal para fruta redondo baixo

| Ref | € | Diámetro varilla (mm) | Ø superior (cm) | Base (cm) | h(cm) | U.Venta |
|-------|-------|-----------------------|-----------------|-----------|-------|---------|
| 61139 | 40,80 | 4 | 39 | 31,3 | 7,6 | 1 |

Madera aglomerada
Agglomerate wood



FE
Iron

Tostadoras Buffet

INOX 18/10 CE 

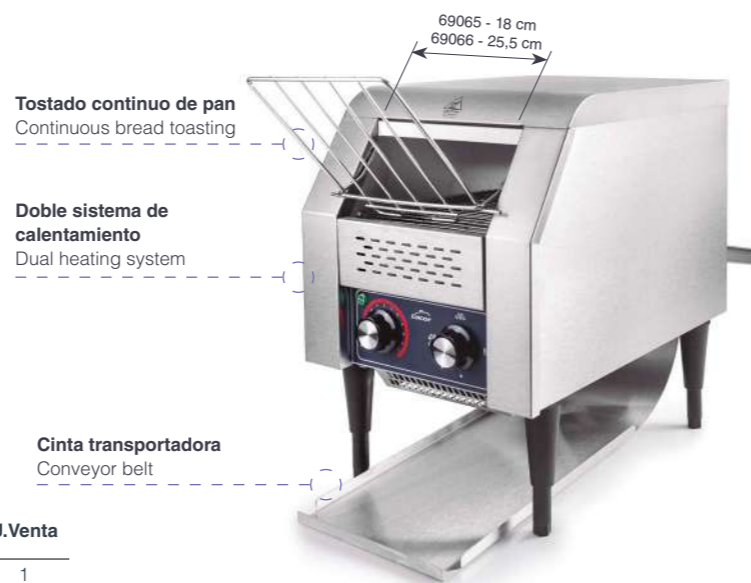

Tostador Continuo

Grille-painl · Toaster
Toaster · Torradeira

| Ref | € | W | Velocidad | Medidas | U.Venta |
|-------|--------|------|---------------|-------------------|---------|
| 69065 | 858,70 | 1340 | 0,46-0,73m/mi | 42x28,5x42 cm | 1 |
| 69066 | 990,40 | 2240 | 0,46-0,73m/mi | 41,6x36,8x29,5 cm | 1 |



Tostador Horizontal

Grille-painl · Toaster
Toaster · Torradeira

| Ref | € | W | Tiempo | Número de lámparas | Grill | Medidas | U.Venta |
|---------|--------|------|----------|--------------------|----------|--------------|---------|
| A 69172 | 364,00 | 2400 | 0-15 min | 6 | 40x24 cm | 50x29x28cm | 1 |
| B 69173 | 430,20 | 3600 | 0-15 min | 9 | 40x24 cm | 50x29x37,5cm | 1 |



Tostadora Buffet

Grille-painl · Toaster
Toaster · Torradeira

| Ref | € | W | Ranuras | Medidas | U.Venta |
|---------|--------|--------|---------|-----------------|---------|
| A 69294 | 237,00 | 1800 W | 4 | 30x24,5x21,5 cm | 1 |
| B 69296 | 314,80 | 2500 W | 6 | 43,5x26x22 cm | 1 |

Fuentes de Chocolate

INOX 18/10 CE 



Fuentes Chocolate

Fontaine chocolat · Schokoladen Fontäne
Chocolate fountain · Fonte chocolate

| Ref | € | W | Temperatura | Capacidad | U.Venta |
|---------|--------|----|-------------|-----------|---------|
| A 69318 | 61,70 | 35 | 40°C -50°C | 0,5L | 1 |
| B 69319 | 105,00 | 80 | 40°C -50°C | 1,8L | 1 |

- Fabricada en acero inoxidable 18/10 de gran calidad.
- Crea una cascada de chocolate fundido y lo mantiene caliente para bañar alimentos.
- Ideal para buffet, hoteles, restaurantes, estas y celebraciones.
- Torre de 18 cm de tres niveles.
- Interruptor de calentamiento independiente.
- Base con apoyos antideslizantes.
- Desmontable.

- Fabriqué en acier inoxydable 18/10 de haute qualité.
- Créez une cascade de chocolat coulée et gardez-la chaude pour baigner les aliments.
- Idéal pour le buffet, les hôtels, les restaurants, ceux-ci et les célébrations.
- Tour de 18 cm de trois niveaux.
- Interrupteur de chauffage indépendant.
- Base avec support non glissé.
- Amovible.

- Made of stainless steel 18/10 of high quality.
- Create a cast chocolate cascade and keep it hot to bathe food.
- Ideal for buffet, hotels, restaurants, these and celebrations.
- 18 cm tower of three levels.
- Independent heating switch.
- Base with non-slip support.
- Removable.

Placa Vitrocerámica Energy

INOX CE 

- Placa vitrocerámica rápida, eficaz, segura, fiable y de gran capacidad de calentamiento.
- Su diseño portátil y compacto resulta ideal para su uso en cualquier lugar.
- Área de cocción de 10 cm / 20 cm de diámetro.
- Botones táctiles, intuitivos y fáciles de utilizar con un toque suave.
- Indicadores luminosos.
- Dispone de función de bloqueo de seguridad para niños.
- Regulable en potencia y temperatura.
- Temporizador de 240 minutos con avisador acústico y auto desconexión.

- Plaque de capacité rapide, efficace, sûre, fiable et de chauffage.
- Sa conception portable et compacte est idéale pour une utilisation n'importe où.
- Zone de cuisson de 10 cm / 20 cm de diamètre.
- Boutons tactiles, intuitifs et faciles à utiliser avec une touche douce.
- Indicateurs lumineux.
- Il a une fonction de verrouillage de sécurité des enfants.
- Réglable en puissance et en température.
- Timer de 240 minutes avec avertissement acoustique et auto-disconnection.

- Fast, effective, safe, reliable and heating capacity plate.
- Its portable and compact design is ideal for use anywhere.
- Cooking area of 10 cm / 20 cm in diameter.
- Tactile buttons, intuitive and easy to use with a soft touch.
- Luminous indicators.
- It has children's security lock function.
- Adjustable in power and temperature.
- 240 minutes timer with acoustic warning and self-disconnection.

Superficie de calentamiento
Heating surface

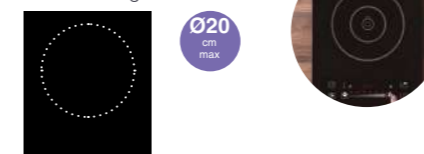

Placa Vitrocerámica Energy

Plaque vitrocéramique · Keramikkochfeld
Ceramic hob · Placa vitrocerámica

| Ref | € | W | Niveles potencia | Tiempo | Superficie placa | Medidas | U.Venta |
|-------|--------|------|------------------|-------------|------------------|--------------|---------|
| 69232 | 115,40 | 2000 | 8 | 240 minutos | Ø10-20 cm | 39x32x5,5 cm | 1 |



Placas de inducción



- Placas de inducción rápidas, eficaces, seguras, fiables y de gran capacidad de calentamiento.
- Sus diseños portátiles y compactos resultan ideales para su uso en cualquier lugar.
- Botones táctiles, intuitivos y fáciles de utilizar con un toque suave.
- Dispone de función de bloqueo de seguridad para niños.
- 40% ahorro de tiempo y energía respecto a otras placas convencionales.

- Plaque à induction rapide, efficace, sûre, fiable et d'une grande capacité de chauffe.
- Sa conception portable et compacte est idéale pour une utilisation n'importe où.
- Boutons tactiles, intuitifs et faciles à utiliser avec un toucher doux.
- Dispose d'une fonction de blocage de sécurité pour les enfants.
- 40% de gain de temps et d'économies d'énergies par rapport à d'autres plaques conventionnelles

- Fast, efficient, safe, reliable induction hob with high heating capacity.
- Its portable and compact design is ideal for use anywhere.
- Intuitive and easy to use soft touch buttons.
- Includes a child safety lock function.
- 40% saving in time and energy compared to other conventional hobs.

Superficie de calentamiento Heating surface



Placa de inducción Profesional Chef

Plaque induction professionnelle · Profi-Induktionsplatte
Professional induction cooktop · Placa de indução profissional

| Ref | € | W | Niveles potencia | Tiempo | Medidas | U.Venta |
|-------|--------|------|------------------|---------|-------------|---------|
| 69132 | 443,20 | 3500 | 17 | 180 min | 34x43x12 cm | 1 |

Superficie de calentamiento Heating surface



Placa de inducción profesional Easy

Plaque induction professionnelle · Profi-Induktionsplatte
Professional induction cooktop · Placa de indução profissional

| Ref | € | W | Niveles potencia | Medidas | U.Venta |
|-------|--------|------|------------------|-----------------|---------|
| 69362 | 380,20 | 3500 | 10 | 34x44,5x12,5 cm | 1 |

Superficie de calentamiento Heating surface



Placa de inducción profesional Roca

Plaque induction professionnelle · Profi-Induktionsplatte
Professional induction cooktop · Placa de indução profissional

| Ref | € | W | Niveles potencia | Tiempo | Medidas | U.Venta |
|-------|--------|------|------------------|---------|-------------|---------|
| 69337 | 374,70 | 2700 | 10 | 180 min | 30x39x10 cm | 1 |

Superficie de calentamiento Heating surface

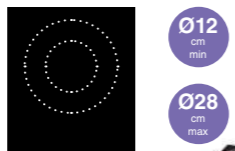

Placa de inducción Pro

Table de cuisine à induction · Induktionskochfeld
Induction cooker · Placa de indução

| Ref | € | W | Niveles potencia | Medidas | U.Venta |
|-------|--------|------|------------------|---------------|---------|
| 69371 | 343,00 | 3500 | 10 | 36x38x12,5 cm | 1 |

Superficie de calentamiento Heating surface



Placa de inducción Slim

Table de cuisine à Induktion · Induktionskochfeld
Induction cooker · Placa de indução

| Ref | € | W | Niveles potencia | Tiempo | Medidas | U.Venta |
|-------|--------|------|------------------|---------|--------------|---------|
| 69332 | 162,70 | 2000 | 8 | 180 min | 30x37x4,5 cm | 1 |

Superficie de calentamiento Heating surface



Posibilidad de encastrar Encastrable option

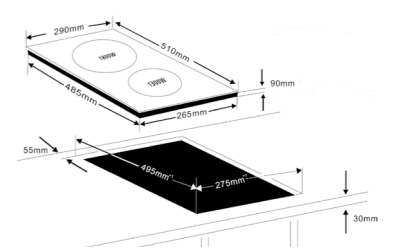

Placa de inducción Dual Vertical

Plaque induction double · Induktionskochfeld doppelt
Double induction cooktop · Placa de indução dupla

| Ref | € | W | Niveles potencia | Tiempo | Medidas | U.Venta |
|-------|--------|-----------|------------------|----------|------------|---------|
| 69033 | 469,70 | 1800+1300 | 8 | 0-99 min | 29x51x9 cm | 1 |

Superficie de calentamiento Heating surface



Posibilidad de encastrar Encastrable option

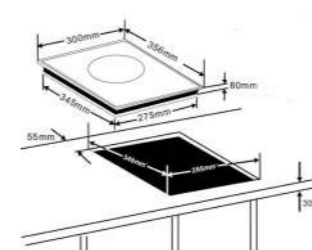

Placa de inducción Expert

Table de cuisine à induction · Induktionskochfeld
Induction cooker · Placa de indução

| Ref | € | W | Niveles potencia | Tiempo | Medidas | U.Venta |
|-------|--------|------|------------------|-----------|--------------|---------|
| 69032 | 286,90 | 2000 | 6 | 0-180 min | 31x36x7,5 cm | 1 |

Superficie de calentamiento Heating surface



Posibilidad de encastrar Encastrable option

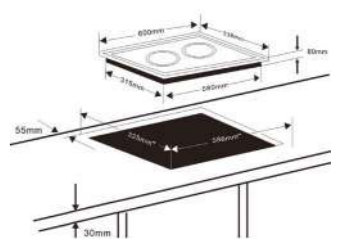

Placa de inducción Dual Horizontal

Plaque induction · Induktionskochfeld doppelt
Induction cooktop · Placa de indução

| Ref | € | W | Niveles potencia | Tiempo | Medidas | U.Venta |
|-------|--------|-----------|------------------|-------------|------------------|---------|
| 69333 | 277,60 | 2000+1500 | 7 | 0 - 180 min | 60 x 34 x 7,5 cm | 1 |

Inox Placa cerámica: Ø26 cm
Ceramic plate: Ø26 cm



INOX

Placa de inducción Wok Profesional

Plaqué à induction wok professionnelle · Induktionskochplatte wok profesional
Induction cooktop wok professional · Placa indução wok profissional

| Ref | € | W | Tiempo | Medidas | U.Venta |
|-------|---------------|--------|---------|-----------------|---------|
| 69138 | 460,20 | 3500 W | 180 min | 34x44,5x12,5 cm | 1 |

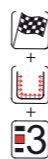

Wok Trimetal

Wok Trimetal · Wok, Trimetal
Trimetal wok · Wok Trimetal

| Ref | € | Ø (cm) | h(cm) | e (mm) | L |
|-------|---------------|--------|---------|--------|------|
| 53836 | 179,20 | 36 | 10,5 cm | 2,7 mm | 5,50 |

Placas calentamiento

INOX 18/10  

- Una solución perfecta para profesionales de la hostelería, buffet, eventos, catering, ferias, etc.
- Ideal para mantener los alimentos calientes antes de servirlos en la mesa a la temperatura perfecta.
- Termostato regulable en temperatura.
- Atención: NO cocinar sobre la misma placa.

- Une solution parfaite pour l'hospitalité, les professionnels du buffet, les événements, la restauration, les foires, etc.
- Idéal pour garder les aliments chauds avant de les servir à la table à la température parfaite.
- Thermostat réglable à température.
- ATTENTION: Ne cuisinez pas dans la même assiette.

- A perfect solution for hospitality, buffet professionals, events, catering, fairs, etc.
- Ideal to keep hot food before serving them at the table at the perfect temperature.
- Adjustable thermostat in temperature.
- Attention: Do not cook on the same plate.



Calentador Buffet 3xGN 1/3

Chauffe · Warmer
Warmer · Aquecedor

| Ref | € | W | Superficie placa | Contenedor | Medidas | U.Venta |
|-------|---------------|-----|------------------|-------------|---------------|---------|
| 69445 | 102,40 | 300 | 53x36 cm | GN 1/3 (x3) | 65x38x15,5 cm | 1 |



Placa calentamiento

Plaqué pour Chauffante · Warmhalteplatte
Warming Plate · Placa aquecimiento

| Ref | € | W | Superficie placa | Medidas | U.Venta |
|-------|--------------|-----|------------------|--------------|---------|
| 69045 | 95,00 | 300 | 53x36 cm | 65x38x6,2 cm | 1 |



Placa calentamiento Vitrocerámica

Plaqué vitrocéramique chaleur · Glaskeramikerheizplatte
Hob heating plate · Placa aquecimiento vitrocerámica

| Ref | € | W | Superficie placa | Temperatura | U.Venta |
|-------|---------------|-----|------------------|-------------|---------|
| 69145 | 210,30 | 230 | 55x36,5 cm | 60-105°C | 1 |



Placa calentamiento Vitro Slim

Plaqué vitrocéramique chaleur · Glaskeramikerheizplatte
Hob heating plate · Placa aquecimiento vitrocerámica

| Ref | € | W | Superficie placa | Temperatura | U.Venta |
|-------|---------------|-----|------------------|-------------|---------|
| 69446 | 104,10 | 230 | 38x45 cm | 60-105°C | 1 |

Calentador Buffet

INOX  

- Ideal para grandes cocinas, buffet, catering o comedores.
- Mantiene los platos a temperatura perfecta durante un tiempo prolongado.
- Estructura de acero inoxidable de alta calidad y resistente.
- Placa calentadora de acero inoxidable con regulación de temperatura entre 40°C - 90°C.
- Lámparas halógenas para garantizar una temperatura homogénea con regulación independiente para cada una de ellas.
- Pantalla protectora de plexiglas altamente resistente.

- Idéal pour les grandes cuisines, buffet, restauration ou salle à manger.
- Gardez la vaisselle à température parfaite pendant longtemps.
- Structure en acier inoxydable de haute qualité et résistante.
- Réfonce en acier inoxydable avec régulation de la température entre 40 ° C à 90 ° C.
- Lampes halogènes pour garantir une température homogène avec une régulation indépendante pour chacun d'eux.
- Écran de protection en plexiglas très résistant.

- Ideal for large kitchens, buffet, catering or dining rooms.
- Keep the dishes at perfect temperature for a long time.
- High quality and resistant stainless steel structure.
- Stainless steel heater with temperature regulation between 40°C - 90°C.
- Halogen lamps to guarantee a homogeneous temperature with independent regulation for each of them.
- Highly resistant plexiglass protective screen.



Incluye bombillas infrarrojos (Ref.: R69061A)
Includes infrared heating bulbs

A Dual

B Triple



Calentador Buffet

Plaqué électrique · Warmhalteplatte
Electric warming plate · Placa aquecimiento eléctrico

| | Ref | € | W (placa) | W (lámpara) | Superficie placa | Medidas | U.Venta |
|----------|-------|---------------|-----------|-------------|------------------|--------------|---------|
| A | 69562 | 533,40 | 500 | 2x250W | 71x50 cm | 78x53x70 cm | 1 |
| B | 69563 | 702,80 | 650 | 3x250W | 99x50 cm | 107x53x70 cm | 1 |

Lámparas de calentamiento

AL Aluminium

- Lámpara calentamiento infrarrojos doble para mantener calientes los platos, las cubetas, etc.
- Diseñada para uso profesional en restauración, buffet, etc.
- Calentamiento por infrarrojos.
- Mantiene calientes los platos, cubetas, chafing dish, etc.
- Altura regulable.
- Incluye dos bombillas.
- Vida útil de la bombilla (2000 horas para uso continuo y 5000 horas para uso intermitente).
- Se aconseja mantener la lámpara a 50 - 60 cm de distancia de los platos.

- Lampe à réchauffement à double infrarouge pour garder la vaisselle, les seaux, etc. chauds, etc.
- Conçu pour une utilisation professionnelle dans la restauration, le buffet, etc.
- Réchauffement infrarouge.
- Gardez la vaisselle, les cuvetas, le frottement, etc.
- Hauteur réglable.
- Comprend deux ampoules.
- Durée de vie de l'ampoule (2000 heures pour une utilisation continue et 5000 heures pour une utilisation intermittent).
- Il est conseillé de garder la lampe à 50 à 60 cm des plats.

- Double infrared warming lamp to keep the dishes, buckets, etc. hot, etc.
- Designed for professional use in restoration, buffet, etc.
- Infrared warming.
- Keep the dishes, cuvetas, chafing dish, etc.
- Adjustable height.
- Includes two bulbs.
- Life of the bulb (2000 hours for continuous use and 5000 hours for intermittent use).
- It is advisable to keep the lamp 50 - 60 cm away from the dishes.

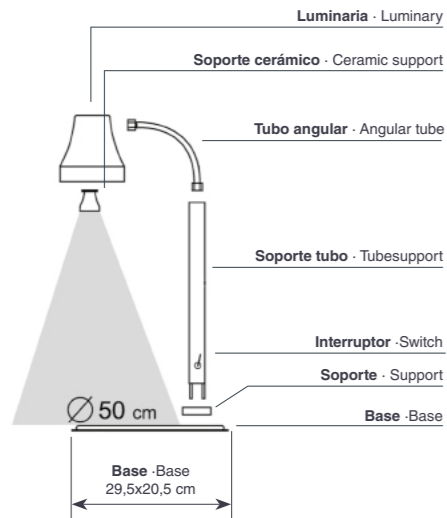

Bombilla infrarrojos
Ampoule infrarouge · Infrarot Glühbirne
Infrared heating bulb · Lampada infravermelho

| Ref | € | W | U. Venta |
|---------|-------|-----|----------|
| R69061A | 10,10 | 275 | 1 |



Lámpara calentamiento infrarrojos
Lampe de chauffage infrarouge · Infrarot Wärmelampe
Infrared heating lamp · Lampara calor infravermelho

| | Ref | € | W | Medidas | h(cm) | U.Venta |
|---|-------|--------|-----|---------|-------|---------|
| A | 69361 | 108,00 | 275 | 34x33cm | 71 | 1 |
| B | 69061 | 149,40 | 550 | 36x45cm | 75 | 1 |



INOX 18/10

Lámpara calentamiento infrarrojos Inox
Lampe de chauffage infrarouge · Infrarot Wärmelampe
Infrared heating lamp · Lampara calor infravermelho

| | Ref | € | W | Medidas | h(cm) | U.Venta |
|---|-------|--------|-----|---------|-------|---------|
| A | 69263 | 486,40 | 275 | 31x23cm | 79 | 1 |
| B | 69264 | 632,30 | 550 | 36x36cm | 76 | 1 |

Lámparas de calentamiento extensibles

AL Aluminium

- Para uso profesional en hostelería.
- Mantiene calientes los platos.
- Calentamiento por infrarrojos.
- Se aconseja mantener la lámpara a 50 - 60 cm de distancia de los platos.
- Incluye bombilla para todas nuestras lámparas de calentamiento.

- Pour un usage professionnel dans la restauration.
- Maintient les plats au chaud.
- Chauffage infrarouge.
- Il est conseillé d'éloigner la lampe de 50 à 60 cm de distance de la vaisselle.
- Comprend une ampoule pour toutes nos lampes chauffantes.

- For professional catering use.
- Keeps the dishes warm.
- Infrared heating.
- It is recommended that the lamp is kept at a distance of 50-60cm from the plates.
- Bulb for all our heating lamps.



Incluye bombillas infrarrojos (Ref.: R69061A)
Includes infrared heating bulbs



Lámparas de calentamiento extensibles

Lampe de chauffage câble extensible · Infrarot Wärmelampe Kabel ausziehbar
Infrared heating lamp extensible · Lampara calor infravermelho cabo extensível

| | Ref | € | W | U.Venta | |
|---|-------|--------|-----|---------|------------------|
| A | 69266 | 130,20 | 275 | 1 | Lijado · Sanding |
| B | 69365 | 149,60 | 275 | 1 | Cromado · Chrome |
| C | 69367 | 149,60 | 275 | 1 | Cobre · Copper |
| D | 69359 | 141,20 | 275 | 1 | Negra · Black |

Lámparas de calentamiento extensibles cónica

Lampe chauffante extensible conique · Wärmelampe Kabel ausziehbar, konisch
Conical heating lamp extensible · Lampada de aquecimento ext. cônica

| | Ref | € | W | U.Venta | |
|---|-------|--------|-----|---------|------------------|
| E | 69564 | 134,80 | 275 | 1 | Lijado · Sanding |
| F | 69566 | 161,80 | 275 | 1 | Cromado · Chrome |
| G | 69565 | 164,60 | 275 | 1 | Cobre · Copper |
| H | 69576 | 151,00 | 275 | 1 | Negra · Black |

Vitrinas



CRISTAL INOX
Glass

Vitrina neutra

Vitrine neutre · Einfache vitrine
Clear countertop display case · Vitrina neutra

| Ref | € | Capacidad | h(cm) | Medidas | U.Venta |
|-------|--------|-----------|-------|---------------|---------|
| 69601 | 293,10 | 45L | 37 | 56x37,6x37 cm | 1 |

- Vitrina neutra construida íntegramente en cristal y base de acero inoxidable.
- Diseñada para presentar y exponer sobre la barra / mostrador.
- Superficie superior curvada para una visión panorámica.
- Estante intermedio de cristal templado.
- Puerta trasera abatible.
- 4 pies de goma que garantizan máxima estabilidad.

- Vitrine neutre construite entièrement dans une base en verre et en acier inoxydable.
- Conçu pour présenter et exposer sur la barre / comptoir.
- Surface supérieure incurvée pour une vue panoramique.
- Étagère en verre trempé intermédiaire.
- Porte arrière pliante.
- 4 pieds en caoutchouc qui garantissent une stabilité maximale.

- Neutral showcase built entirely in glass and stainless steel base.
- Designed to present and expose on the bar / counter.
- Curved upper surface for a panoramic view.
- Intermediate tempered glass shelf.
- Folding rear door.
- 4 rubber feet that guarantee maximum stability.

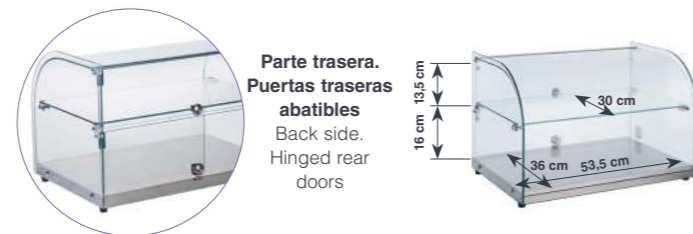

Parte trasera.
Puertas traseras
abatibles
Back side.
Hinged rear
doors



IPX4

CRISTAL INOX
Glass

Vitrina térmica

Vitrine thermique · Warmhaltevitrine
Thermal display case · Vitrina tèrmica

| Ref | € | W | Capacidad | Temperatura | Protección | Medidas | U.Venta |
|-------|--------|-----|-----------|-------------|------------|-----------------|---------|
| 69604 | 592,80 | 800 | 45L | 30°C-90°C | IPX4 | 55,5x37,5x37 cm | 1 |

- Vitrina térmica fabricada en acero inoxidable y cristal.
- Diseñada para conservar, presentar y exponer sobre la barra / mostrador.
- Puerta trasera abatible.
- Superficie superior inclinada para una visión panorámica.
- Recipiente de agua extraíble que aporta humedad en la cámara.
- Termostato de control de temperatura regulable: 30-90°C.
- Bandeja de rejilla extraíble que facilita el lujo del calor.

- Vitrine thermique fabriquée en acier inoxydable et en verre.
- Conçu pour conserver, présenter et exposer sur la barre / comptoir.
- Porte arrière pliante.
- Supérieur submergé pour une vue panoramique.
- Récipient d'eau amovible qui apporte l'humidité dans la chambre.
- Thermostat de commande de température réglable: 30-90°C.
- Plateau de grille amovible qui facilite le luxe de la chaleur.

- Thermal showcase manufactured in stainless steel and glass.
- Designed to conserve, present and expose on the bar / counter.
- Folding rear door.
- Superior overwhelmed for a panoramic view.
- Removable water container that brings moisture in the chamber.
- Adjustable temperature control thermostat: 30-90°C.
- Removable grid tray that facilitates the luxury of heat.



Parte trasera.
Puertas traseras
abatibles
Back side.
Hinged rear
doors



4
Cubetas
Containers



6
Cubetas
Containers

CRISTAL INOX
Glass

Vitrina térmica con cubetas

Vitrine thermique · Warmhaltevitrine
Thermal display case · Vitrina tèrmica

| | Ref | € | W | Capacidad | Temperatura | Protección | Medidas | U.Venta |
|---|-------|--------|-----|-----------|-------------|------------|-----------------|---------|
| A | 69602 | 653,60 | 500 | 4x GN 1/3 | 30°C-90°C | IPX4 | 77,5x42x33,5 cm | 1 |
| B | 69603 | 751,40 | 800 | 6x GN 1/3 | 30°C-90°C | IPX4 | 113x42x33,5 cm | 1 |

- Vitrina térmica fabricada en acero inoxidable y cristal.
- Diseñada para conservar, presentar y exponer sobre la barra / mostrador.
- Puertas correderas para una accesibilidad total.
- Superficie superior curvada para una visión panorámica.
- Cubetas gastronorm 1/3 incluidas.
- Termostato de control de temperatura regulable: 30 - 90°C.

- Vitrine thermique fabriquée en acier inoxydable et en verre.
- Conçu pour conserver, présenter et exposer sur la barre / comptoir.
- Portes coulissantes pour l'accessibilité totale.
- Superficie Curvada Superior pour une vue panoramique.
- Cubetas Gastronorm 1/3 inclus.
- Thermostat de commande de température réglable: 30 - 90 ° C.

- Thermal showcase manufactured in stainless steel and glass.
- Designed to conserve, present and expose on the bar / counter.
- Sliding doors for total accessibility.
- Superficie Curvada superior for a panoramic view.
- Gastronorm 1/3 trays included.
- Adjustable temperature control thermostat: 30 - 90°C.



Parte trasera.
Puertas traseras
correderas.
4 / 6 cubetas gastro-
norm 1/3 incluidas
Back side.
Sliding rear doors.
4/6 Gastronorm 1/3
trays included

IPX4



CRISTAL INOX
Glass

Vitrina refrigerada

Vitrine réfrigérée · Kühlvitrine
Refrigerated display case · Vitrina refrigerada

| Ref | € | W | Capacidad | Temperatura | Refrigerante | Medidas | U.Venta |
|-------|---------|-----|-----------|-------------|--------------|-------------|---------|
| 69607 | 1113,60 | 105 | 40L | 2-12°C | R600a | 68x58x34 cm | 1 |

- Vitrina refrigerada construida íntegramente en cristal y acero inoxidable.
- Diseñada para conservar, presentar y exponer sobre la barra / mostrador.
- Puertas correderas para una accesibilidad total.
- Superficie superior inclinada para una visión panorámica.
- Sistema de enfriamiento por compresor. Función Defrost.
- Termostato de control de temperatura regulable: 2-12°C.
- Sist. de iluminación LED en la cámara interior y display de control de mandos.

- Vitrine réfrigérée construite entièrement en verre et en acier inoxydable.
- Conçu pour conserver, présenter et exposer sur la barre / comptoir.
- Portes coulissantes pour l'accessibilité totale.
- Surface supérieure inclinée pour une vue panoramique.
- Système de refroidissement du compresseur. Fonction de dégivrage.
- Thermostat de commande de température réglable: 2-12°C.
- Syst. d'éclairage LED dans la chambre intérieure et le contrôle des commandes.

- Refrigerated showcase built entirely in glass and stainless steel.
- Designed to conserve, present and expose on the bar / counter.
- Sliding doors for total accessibility.
- Inclined upper surface for a panoramic view.
- Compressor cooling system. Defrost function.
- Adjustable temperature control thermostat: 2-12°C.
- Syst. of LED lighting in the inner chamber and control of controls.



Parte trasera
Back side

A

4
Cubetas
Containers

B

6
Cubetas
Containers

- Vitrina refrigerada construida íntegramente en cristal y acero inoxidable.
- Diseñada para conservar, presentar y exponer sobre la barra / mostrador.
- Puertas correderas para una accesibilidad total.
- Superficie superior curvada para una visión panorámica.
- Sistema de enfriamiento por compresor.
- Cubetas gastronorm 1/3 incluidas.
- Termostato de control de temperatura regulable: 0-12°C.
- Sistema de iluminación LED en la cámara interior y display de control de mandos.

- Vitrine réfrigérée construite entièrement en verre et en acier inoxydable.
- Conçu pour conserver, présenter et exposer sur la barre / comptoir.
- Portes coulissantes pour l'accessibilité totale.
- Surface supérieure incurvée pour une vue panoramique.
- Système de refroidissement du compresseur.
- Cubetas Gastronorm 1/3 inclus.
- Thermostat de commande de température réglable: 0-12°C.
- Système d'éclairage LED dans l'écran de commande de la chambre intérieure et de la commande.

- Refrigerated showcase built entirely in glass and stainless steel.
- Designed to conserve, present and expose on the bar / counter.
- Sliding doors for total accessibility.
- Curved upper surface for a panoramic view.
- Compressor cooling system.
- Gastronorm 1/3 trays included.
- Adjustable temperature control thermostat: 0-12°C.
- LED lighting system in the inner chamber and control control display.



Control de temperatura regulable

Temperature control thermostat

Puertas traseras correderas
Sliding rear doors

INOX

CRISTAL
Glass

Vitrina refrigerada con cubetas

Vitrine réfrigérée · Kühlvitrine

Refrigerated display case · Vitrina refrigerada

| | Ref | € | W | Capacidad | Temperatura | Refrigerante | Medidas | U.Venta |
|---|-------|---------|-----|-----------|-------------|--------------|----------------|---------|
| A | 69605 | 1270,50 | 160 | 4x GN 1/3 | 0°C-12°C | R600a | 112,1x45x33 cm | 1 |
| B | 69606 | 1408,60 | 160 | 6x GN 1/3 | 0°C-12°C | R600a | 148,3x45x33 cm | 1 |

69602

Combinaciones posibles
Possible combinations

| | |
|--------|--------|
| GN 2/3 | GN 2/3 |
|--------|--------|

| | | | |
|--------|--------|--------|--------|
| GN 1/3 | GN 1/3 | GN 1/3 | GN 1/3 |
|--------|--------|--------|--------|

69603

Combinaciones posibles
Possible combinations

| | | |
|--------|--------|--------|
| GN 2/3 | GN 2/3 | GN 2/3 |
|--------|--------|--------|

| | | | |
|--------|--------|--------|--------|
| GN 1/2 | GN 1/2 | GN 1/2 | GN 1/2 |
|--------|--------|--------|--------|

| | | | | | |
|--------|--------|--------|--------|--------|--------|
| GN 1/3 | GN 1/3 | GN 1/3 | GN 1/3 | GN 1/3 | GN 1/3 |
|--------|--------|--------|--------|--------|--------|

Gastronorm

Gastronorm

Soporte para cubetas

INOX 18/10

COMPATIBILIDAD DE CUBETAS CON LOS SOPORTES CONTAINERS COMPATIBILITY WITH SUPPORTS

| | INOX 18/10 | INOX | PC | PP | MELAMINA |
|--|------------|------|----|----|----------|
| | X | X | | | |
| | ✓ | ✓ | ✓ | X | ✓ |
| | ✓ | ✓ | ✓ | | ✓ |
| | X | X | | | X |
| | ✓ | ✓ | ✓ | X | ✓ |
| | ✓ | ✓ | ✓ | ✓ | ✓ |
| | X | X | ✓ | X | X |
| | ✓ | ✓ | ✓ | ✓ | ✓ |
| | ✓ | ✓ | ✓ | ✓ | ✓ |

- Fabricado en acero inoxidable 18/10.
- Organiza los alimentos y ahorra tiempo en la preparación de platos.
- Ideal para cocinas profesionales, restaurantes, buffet, autoservicios, etc.
- Travesaños verticales amovibles diseñados para combinar cubetas de distintos tamaños de hasta 200 mm de profundidad.
- Pies de goma antideslizantes que garantizan una óptima estabilidad.

- Fabriqué en acier inoxydable 18/10.
- Organisez les aliments et gagnez du temps lors de la préparation de vos plats.
- Idéal pour les cuisines professionnelles, les restaurants, les buffets, les self-services, etc.
- Barres transversales verticales amovibles conçues pour combiner des bacs de différentes tailles de 200 mm de profondeur.
- Pieds en caoutchouc antidérapants qui garantissent une stabilité optimale.

- Made of 18/10 stainless steel.
- Organize food and save time while making dishes.
- Perfect for professional chefs, restaurants, buffets, self-service, etc.
- It has removable vertical cross pieces designed to combine trays of different sizes to 200 mm deep.
- The non-slip rubber feet ensure optimum stability.

Diversas combinaciones posibles Several possible combinations

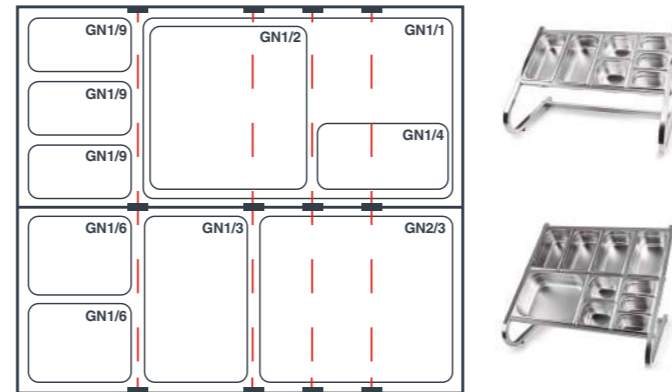

INOX 18/10

Soporte para cubetas

Support de bacs Gastronom · Unterstützung für Gastronom-Küvetten
Gastronom cuvette support · Suporte de cubeta Gastronom

| | Ref | € | cm | U.Venta |
|---|-------|--------|----------|---------|
| A | 66245 | 84,10 | 78x49x46 | 1 |
| B | 66246 | 108,30 | 78x78x63 | 1 |

Soporte simple · Simple support
Soporte doble · Double support

Cubetas Inox 18/10 - Inox

INOX 18/10



- Fabricadas en acero inoxidable y acero inoxidable 18/10.
- Aptas para procesos de refrigeración, congelación, hornos microondas o distribución de alimentos.
- Higiénicos y fácilmente lavables, aptas para el lavavajillas.

- Fabriquées en acier inoxydable et en acier inoxydable 18/10.
- Compatibles pour des processus de réfrigération, congélation, fours à micro-ondes ou distribution d'aliments.
- Hygiéniques et facilement lavables, compatible lave-vaisselle.

- Manufactured in stainless steel and stainless steel 18/10.
- Suitable for refrigeration and freezing processes, microwave ovens or food distribution.
- Hygienic and easily washable, dishwasher safe.

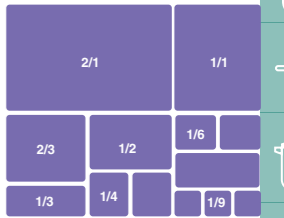

2/1
530 x 650 mm



Cubeta 2/1

Bac 2/1 · GN-Behälter 2/1
Container 2/1 · Caixa 2/1

| Inox 18/10 | Inox | Ref | € | L | h (cm) | U.Venta | | |
|------------|------|-------|--------|--------|--------|---------|------|---|
| | | 66002 | 44,70 | 66002Z | 39,70 | 6,50 | 2,0 | 1 |
| | | 66040 | 49,40 | 66040Z | 44,80 | 11,00 | 4,0 | 1 |
| | | 66065 | 56,30 | 66065Z | 47,10 | 18,90 | 6,5 | 1 |
| | | 66010 | 68,80 | 66010Z | 57,60 | 31,50 | 10,0 | 1 |
| | | 66015 | 83,10 | 66015Z | 72,50 | 44,90 | 15,0 | 1 |
| | | 66020 | 108,10 | 66020Z | 96,70 | 60,00 | 20,0 | 1 |

Cubeta perforada 2/1

Bac perfore 2/1 · GN-Behälter, perforiert, 2/1
Perforated container 2/1 · Caixa perforada 2/1

| Inox 18/10 | Inox | Ref | € | h (cm) | U.Venta | | | |
|------------|------|-------|--------|--------|---------|------|---|------------------|
| | | - | - | - | - | | | |
| | | 66042 | 60,60 | - | - | | | |
| | | 66067 | 76,20 | 66067Z | 53,50 | 6,5 | 1 | NO perf. lateral |
| | | 66012 | 93,90 | 66012Z | 65,80 | 10,0 | 1 | NO perf. lateral |
| | | 66017 | 140,60 | - | - | 15,0 | 1 | NO perf. lateral |

1/1
530 x 325 mm



Cubeta 1/1

Bac 1/1 · GN-Behälter 1/1
Container 1/1 · Caixa 1/1

| Inox 18/10 | Inox | Ref | € | h (cm) | L | U.Venta | | |
|------------|------|-------|-------|--------|-------|---------|-------|---|
| | | 66102 | 22,10 | 66102Z | 18,70 | 2,0 | 3,00 | 1 |
| | | 66140 | 23,20 | 66140Z | 20,00 | 4,0 | 5,50 | 1 |
| | | 66155 | 26,00 | 66155Z | 21,20 | 5,5 | 7,20 | 1 |
| | | 66165 | 28,00 | 66165Z | 21,90 | 6,5 | 8,50 | 1 |
| | | 66110 | 39,80 | 66110Z | 29,80 | 10,0 | 13,30 | 1 |
| | | 66115 | 47,20 | 66115Z | 40,90 | 15,0 | 20,60 | 1 |
| | | 66120 | 55,70 | 66120Z | 49,60 | 20,0 | 30,00 | 1 |

Cubeta perforada 1/1

Bac perfore 1/1 · GN-Behälter, perforiert, 1/1
Perforated container 1/1 · Caixa perforada 1/1

| Inox 18/10 | Inox | Ref | € | h (cm) | U.Venta | | |
|------------|------|-------|-------|--------|---------|------|---|
| | | 66104 | 33,30 | - | - | | |
| | | 66142 | 39,60 | 66142Z | 22,30 | 4,0 | 1 |
| | | - | - | - | - | | |
| | | 66167 | 43,70 | 66167Z | 24,10 | 6,5 | 1 |
| | | 66112 | 56,30 | 66112Z | 33,70 | 10,0 | 1 |
| | | 66117 | 83,50 | 66117Z | 54,40 | 15,0 | 1 |
| | | 66122 | 95,80 | 66122Z | 66,00 | 20,0 | 1 |

2/3
354 x 325 mm



Cubeta 2/3

Bac 2/3 · GN-Behälter 2/3
Container 2/3 · Caixa 2/3

| Inox 18/10 | Inox | Ref | € | h (cm) | L | U.Venta | | |
|------------|------|-------|-------|--------|-------|---------|-------|---|
| | | 66502 | 19,20 | 66502Z | 15,80 | 2,0 | 1,70 | 1 |
| | | 66540 | 24,20 | 66540Z | 20,50 | 4,0 | 3,50 | 1 |
| | | 66565 | 27,70 | 66565Z | 23,20 | 6,5 | 5,50 | 1 |
| | | 66510 | 34,40 | 66510Z | 28,80 | 10,0 | 8,90 | 1 |
| | | 66515 | 48,10 | 66515Z | 40,10 | 15,0 | 13,60 | 1 |
| | | 66520 | 64,00 | 66520Z | 53,60 | 20,0 | 19,30 | 1 |

Cubeta perforada 2/3

Bac perfore 2/3 · GN-Behälter, perforiert, 2/3
Perforated container 2/3 · Caixa perforada 2/3

| Inox 18/10 | Inox | Ref | € | h (cm) | U.Venta | | |
|------------|------|-----|---|--------|---------|------|---|
| | | - | - | - | - | | |
| | | - | - | - | - | | |
| | | - | - | 66567Z | 20,70 | 6,5 | 1 |
| | | - | - | 66512Z | 29,60 | 10,0 | 1 |
| | | - | - | 66517Z | 40,10 | 15,0 | 1 |

Cubeta 1/2

Bac 1/2 · GN-Behälter 1/2
Container 1/2 · Caixa 1/2



1/2
265 x 325 mm

| Inox 18/10 | | Inox | | h (cm) | L | U.Venta |
|------------|-------|--------|-------|--------|-------|---------|
| Ref | € | Ref | € | | | |
| 66202 | 14,90 | 66202Z | 10,50 | 2,0 | 1,20 | 1 |
| 66240 | 15,70 | 66240Z | 10,90 | 4,0 | 2,50 | 1 |
| - | - | 66255Z | 12,20 | 5,5 | 3,20 | 1 |
| 66265 | 17,90 | 66265Z | 12,70 | 6,5 | 4,20 | 1 |
| 66210 | 26,00 | 66210Z | 17,90 | 10,0 | 8,00 | 1 |
| 66215 | 33,30 | 66215Z | 25,70 | 15,0 | 9,90 | 1 |
| 66220 | 42,60 | 66220Z | 31,70 | 20,0 | 11,60 | 1 |

Cubeta perforada 1/2

Bac perfore 1/2 · GN-Behälter, perforiert, 1/2
Perforated container 1/2 · Caixa perforada 1/2



| Inox 18/10 | | Inox | | h(cm) | U.Venta |
|------------|-------|------|---|-------|---------|
| Ref | € | Ref | € | | |
| - | - | - | - | - | - |
| 66242 | 28,10 | - | - | 4,0 | 1 |
| - | - | - | - | - | - |
| 66267 | 32,20 | - | - | 6,5 | 1 |
| 66212 | 39,50 | - | - | 10,0 | 1 |
| 66217 | 53,50 | - | - | 15,0 | 1 |
| 66222 | 74,30 | - | - | 20,0 | 1 |

Cubeta 2/4

Bac 2/4 · GN-Behälter 2/4
Container 2/4 · Caixa 2/4



2/4
530 x 165 mm

| Inox 18/10 | | Inox | | h (cm) | L | U.Venta |
|------------|-------|--------|-------|--------|------|---------|
| Ref | € | Ref | € | | | |
| 67604 | 20,90 | 67604Z | 17,40 | 4,0 | 1,80 | 1 |
| 67665 | 23,70 | 67665Z | 19,50 | 6,5 | 4,50 | 1 |
| 67610 | 29,40 | 67610Z | 24,20 | 10,0 | 5,50 | 1 |
| 67615 | 44,40 | 67615Z | 36,40 | 15,0 | 8,50 | 1 |

Cubeta 1/3

Bac 1/3 · GN-Behälter 1/3
Container 1/3 · Caixa 1/3



1/3
176 x 325 mm

| Inox 18/10 | | Inox | | h (cm) | L | U.Venta |
|------------|-------|--------|-------|--------|------|---------|
| Ref | € | Ref | € | | | |
| 66302 | 14,00 | 66302Z | 7,90 | 2,0 | 0,80 | 6 |
| 66340 | 14,10 | 66340Z | 8,70 | 4,0 | 1,60 | 6 |
| 66355 | 14,50 | 66355Z | 9,00 | 5,5 | 2,00 | 6 |
| 66365 | 14,70 | 66365Z | 9,20 | 6,5 | 2,50 | 6 |
| 66310 | 21,10 | 66310Z | 14,50 | 10,0 | 3,80 | 1 |
| 66315 | 30,80 | 66315Z | 19,50 | 15,0 | 5,90 | 1 |
| 66320 | 35,30 | 66320Z | 23,00 | 20,0 | 8,10 | 1 |

Cubeta 1/4

Bac 1/4 · GN-Behälter 1/4
Container 1/4 · Caixa 1/4



1/4
265 x 162 mm

| Inox 18/10 | | Inox | | h (cm) | L | U.Venta |
|------------|-------|--------|-------|--------|------|---------|
| Ref | € | Ref | € | | | |
| 66402 | 10,50 | 66402Z | 7,20 | 2,0 | 0,60 | 6 |
| 66465 | 11,70 | 66465Z | 7,90 | 6,5 | 1,90 | 6 |
| 66410 | 17,50 | 66410Z | 12,30 | 10,0 | 2,50 | 1 |
| 66415 | 24,00 | 66415Z | 16,40 | 15,0 | 4,10 | 1 |
| 66420 | 32,70 | 66420Z | 19,80 | 20,0 | 4,90 | 1 |

Cubeta 1/6

Bac 1/6 · GN-Behälter 1/6
Container 1/6 · Caixa 1/6



1/6
176 x 162 mm

| Inox 18/10 | | Inox | | h (cm) | L | U.Venta |
|------------|-------|--------|-------|--------|------|---------|
| Ref | € | Ref | € | | | |
| 66665 | 9,50 | 66665Z | 6,40 | 6,5 | 1,10 | 6 |
| 66610 | 15,20 | 66610Z | 9,80 | 10,0 | 1,60 | 6 |
| 66615 | 23,80 | 66615Z | 13,60 | 15,0 | 2,50 | 1 |
| 66620 | 29,90 | 66620Z | 16,10 | 20,0 | 3,30 | 1 |

Cubeta 1/9

Bac 1/9 · GN-Behälter 1/9
Container 1/9 · Caixa 1/9



1/9
176 x 108 mm

| Inox 18/10 | | Inox | | h (cm) | L | U.Venta |
|------------|-------|--------|------|--------|------|---------|
| Ref | € | Ref | € | | | |
| 66965 | 8,20 | 66965Z | 4,70 | 10,0 | 0,70 | 6 |
| 66910 | 14,30 | 66910Z | 7,50 | 6,5 | 0,85 | 6 |

Guia divisora

Guide de division · GN Zwischensteg
Splitting guides · Guia divisória



| Inox 18/10 | | Inox | | Largo (cm) | U.Venta |
|------------|-------|--------|------|------------|---------|
| Ref | € | Ref | € | | |
| 66923 | 13,60 | 66923Z | 5,70 | 53,0 | 1 |
| 66925 | 10,10 | 66925Z | 3,70 | 32,5 | 1 |

Doble fondo perforado

Double fond perforé · Doppel-Boden gelocht
Punched double bottom perf. · Duplo fundo perforado



| Inox 18/10 | | Inox | | Cubeta |
|------------|--------|--------|-------|--------|
| Ref | € | Ref | € | |
| 66909 | 103,50 | - | - | 2/1 |
| 66911 | 33,00 | 66911Z | 21,90 | 1/1 |
| 66912 | 22,50 | 66912Z | 14,80 | 1/2 |

Tapa para cubeta

Couvercle pour bac · GN Deckel
Container lid · Tampa para caixa



| Inox 18/10 | | Inox | | Cubeta | U.Venta |
|------------|-------|--------|-------|--------|---------|
| Ref | € | Ref | € | | |
| 67901 | 24,70 | 67901Z | 17,30 | 1/1 | 1 |
| 67905 | 15,10 | 67905Z | 10,50 | 2/3 | 1 |
| 67902 | 13,50 | 67902Z | 9,30 | 1/2 | 6 |
| 67903 | 9,80 | 67903Z | 6,70 | 1/3 | 6 |
| 67904 | 8,20 | 67904Z | 5,70 | 1/4 | 6 |
| 67906 | 6,70 | 67906Z | 4,70 | 1/6 | 6 |
| 67909 | 5,70 | 67909Z | 4,00 | 1/9 | 6 |

Tapa para cubeta con pomo

Couvercle pour bac · GN Deckel
Container lid · Tampa para caixa



| Inox 18/10 | | Inox | | Cubeta | U.Venta |
|------------|-------|---------|-------|--------|---------|
| Ref | € | Ref | € | | |
| - | - | 66908DZ | 36,10 | 2/1 | 1 |
| 66901D | 24,90 | 66901DZ | 17,20 | 1/1 | 1 |
| 66905D | 19,70 | 66905DZ | 11,80 | 2/3 | 1 |
| 66907 | 15,90 | - | - | 2/4 | 1 |
| 66902D | 13,10 | 66902DZ | 8,40 | 1/2 | 6 |
| 66903D | 10,50 | 66903DZ | 6,50 | 1/3 | 6 |
| 66904D | 8,90 | 66904DZ | 6,00 | 1/4 | 6 |
| 66906D | 6,70 | 66906DZ | 3,50 | 1/6 | 6 |
| 66909D | 6,20 | 66909DZ | 2,60 | 1/9 | 6 |

SI

Silicone



Tapa para cubeta Red

Couvercle pour bac · GN Deckel
Container lid · Tampa para caixa

| Inox 18/10 | | Inox | | Cubeta | U.Venta |
|------------|-------|--------|-------|--------|---------|
| Ref | € | Ref | € | | |
| 66901 | 73,20 | 66901Z | 43,70 | 1/1 | 1 |
| 66903 | 59,10 | 66903Z | 30,90 | 2/3 | 1 |
| 66902 | 53,60 | 66902Z | 34,40 | 1/2 | 1 |
| 66904 | 43,40 | 66904Z | 24,00 | 1/3 | 1 |
| 66905 | 40,10 | 66905Z | 22,30 | 1/4 | 1 |

Varilla · Rod: Ø6 mm

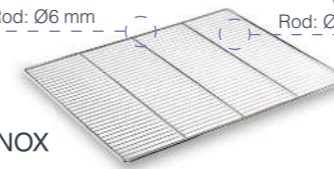

Varilla
Rod: Ø3 mm

Parrilla

Grille · Gitter, Rost
Grate · Grelha

| Ref | € | cm | Medidas Cubeta | U.Venta |
|-------|-------|---------|----------------|---------|
| 66920 | 55,10 | 65x53 | 2/1 | 1 |
| 66921 | 21,20 | 53x32,5 | 1/1 | 1 |

INOX

Pinza para bandeja GN

Pince inox pour bac Gastronorm · Zange für GN Behälter
Tong GN tray · Pinça para forno e bandejas GN

| Ref | € | Largo (cm) | U.Venta |
|-------|-------|------------|---------|
| 62989 | 17,50 | 20 | 12 |

INOX 200°C
Max



Pinza para bandeja GN con silicona

Pince inox pour bac Gastronorm · Zange für GN Behälter
Tong GN tray · Pinça para forno e bandejas GN

| Ref | € | Largo (cm) | U.Venta |
|-------|-------|------------|---------|
| 62998 | 17,50 | 20 | 12 |

Especial para helado



Cubeta para helado Inox 18/10

Bac à glace · Eiskübel
Ice cream container · Caixa de sorvete

| Ref | € | cm | h(cm) | L | U.Venta |
|----------|-------|---------|-------|-----|---------|
| 66178 | 27,80 | 36x16,5 | 8 | 3,8 | 1 |
| 66172 | 27,90 | 36x16,5 | 12 | 5,0 | 1 |
| 66175 | 35,20 | 36x16,5 | 15 | 6,5 | 1 |
| A 66900P | 9,90 | 36x16,5 | 7,6 | - | 1 |



PC
Policarbonato

Cubeta para helado Policarbonato

Bac à glace · Eiskübel
Ice cream container · Caixa de sorvete

| Ref | € | cm | h(cm) | L | U.Venta |
|----------|------|---------|-------|-----|---------|
| A 66172P | 9,90 | 36x16,5 | 12,0 | 5,0 | 6 |
| B 66908P | 6,80 | 36x16,5 | 2 | - | 6 |

A- Compatible con tapas (66900P/66908P)

Compatible with lids (66900P/66908P)

B- Compatible con cubetas (66175/66172P)

Compatible with containers (669175/66172P)

Cubetas Policarbonato



- Fabricada en policarbonato. Ligera, indeformable y apilable.
- Apta para procesos de refrigeración, congelación, hornos microondas o distribución de alimentos (-100°C/100°C).
- Higiénica y fácilmente lavable. Apta para el lavavajillas.

- Fabriqué en polycarbonate. Léger, indéformable et empilable.
- Convient pour le refroidissement, le congélation, les fours à micro-ondes ou la distribution des aliments (-100 ° C / 100 ° C).
- Hygiénique et facilement lavable. Convient au lave-vaisselle.

- Manufactured in polycarbonate. Light, undeformable and stackable.
- Suitable for cooling, freezing, microwave ovens or food distribution (-100°C/100°C).
- Hygienic and easily washable. Suitable for dishwasher.

1/1
530 x 325 mm



1/2
265 x 325 mm



1/3
176 x 325 mm



Cubeta 1/1

Bac 1/1 · GN-Behälter 1/1
Container 1/1 · Caixa 1/1

| Ref | € | h (cm) | L | U.Venta |
|--------|-------|--------|-------|---------|
| 66165P | 24,00 | 6,5 | 8,50 | 1 |
| 66110P | 29,60 | 10,0 | 13,30 | 1 |
| 66115P | 36,30 | 15,0 | 20,60 | 1 |
| 66120P | 44,70 | 20,0 | 30,00 | 1 |

Cubeta 1/2

Bac 1/2 · GN-Behälter 1/2
Container 1/2 · Caixa 1/2

| Ref | € | h (cm) | L | U.Venta |
|--------|-------|--------|-------|---------|
| 66265P | 12,70 | 6,5 | 4,20 | 1 |
| 66210P | 16,90 | 10,0 | 8,00 | 1 |
| 66215P | 21,80 | 15,0 | 9,90 | 1 |
| 66220P | 26,60 | 20,0 | 11,60 | 1 |

Cubeta 1/3

Bac GN 1/3 · GN-Behälter 1/3
GN container 1/3 · Caixa GN 1/3

| Ref | € | h (cm) | L | U.Venta |
|--------|-------|--------|------|---------|
| 66365P | 10,40 | 6,5 | 2,50 | 1 |
| 66310P | 13,50 | 10,0 | 3,80 | 1 |
| 66315P | 16,80 | 15,0 | 5,90 | 1 |
| 66320P | 20,40 | 20,0 | 8,10 | 1 |

1/4
265 x 162 mm



1/6
176 x 162 mm



1/9
176 x 108 mm



Cubeta 1/4

Bac 1/4 · GN-Behälter 1/4
Container 1/4 · Caixa 1/4

| Ref | € | h (cm) | L | U.Venta |
|--------|-------|--------|------|---------|
| 66465P | 9,20 | 6,5 | 1,90 | 1 |
| 66410P | 11,00 | 10,0 | 2,50 | 1 |
| 66415P | 13,90 | 15,0 | 4,10 | 1 |

Cubeta 1/6

Bac 1/6 · GN-Behälter 1/6
Container 1/6 · Caixa 1/6

| Ref | € | h (cm) | L | U.Venta |
|--------|-------|--------|------|---------|
| 66665P | 7,80 | 6,5 | 1,10 | 1 |
| 66610P | 8,30 | 10,0 | 1,60 | 1 |
| 66615P | 10,00 | 15,0 | 2,50 | 1 |

Cubeta 1/9

Bac 1/9 · GN-Behälter 1/9
Container 1/9 · Caixa 1/9

| Ref | € | h (cm) | L | U.Venta |
|--------|------|--------|------|---------|
| 66910P | 7,80 | 10,0 | 0,70 | 1 |

Tapa

Couvercle · Deckel
Lid · Tampa

| Ref | € | Cubeta | U.Venta |
|--------|-------|--------|---------|
| 66901P | 18,30 | 1/1 | 1 |
| 66902P | 11,30 | 1/2 | 1 |
| 66903P | 8,00 | 1/3 | 1 |
| 66904P | 6,60 | 1/4 | 1 |
| 66906P | 4,90 | 1/6 | 1 |
| 66909P | 3,90 | 1/9 | 1 |

Doble fondo perforado

Double fond perce · GN Einlege-Böden, gelocht
Punched double bottom · Duplo fundo perforado

| Ref | € | Cubeta | U.Venta |
|--------|-------|--------|---------|
| 66911P | 13,70 | 1/1 | 1 |
| 66912P | 7,50 | 1/2 | 1 |
| 66913P | 4,80 | 1/3 | 1 |
| 66914P | 3,80 | 1/4 | 1 |
| 66916P | 3,40 | 1/6 | 1 |

Cubetas Polipropileno



- Fabricada en policarbonato. Ligera, indeformable y apilable.
- Apta para procesos de refrigeración, congelación, hornos microondas o distribución de alimentos (-100°C/100°C).
- Higiénica y fácilmente lavable. Apta para el lavavajillas.

- Fabriqué en polycarbonate. Léger, indéformable et empilable.
- Convient pour le refroidissement, le congélation, les fours à micro-ondes ou la distribution des aliments (-100 ° C / 100 ° C).
- Hygiénique et facilement lavable. Convient au lave-vaisselle.

- Manufactured in polycarbonate. Light, undeformable and stackable.
- Suitable for cooling, freezing, microwave ovens or food distribution (-100°C/100°C).
- Hygienic and easily washable. Suitable for dishwasher.

1/1
530 x 325 mm



1/2
265 x 325 mm



1/3
176 x 325 mm



Cubeta 1/1

Bac 1/1 · GN-Behälter 1/1
Container 1/1 · Caixa 1/1

| Ref | € | h (cm) | L | U.Venta |
|--------|-------|--------|-------|---------|
| 66165H | 11,30 | 6,5 | 8,50 | 1 |
| 66110H | 13,50 | 10,0 | 12,90 | 1 |
| 66115H | 16,90 | 15,0 | 19,50 | 1 |
| 66120H | 21,60 | 20,0 | 25,90 | 1 |

Cubeta 1/2

Bac 1/2 · GN-Behälter 1/2
Container 1/2 · Caixa 1/2

| Ref | € | h (cm) | L | U.Venta |
|--------|-------|--------|-------|---------|
| 66265H | 5,90 | 6,5 | 3,90 | 6 |
| 66210H | 8,30 | 10,0 | 5,90 | 6 |
| 66215H | 9,70 | 15,0 | 8,80 | 6 |
| 66220H | 11,40 | 20,0 | 10,80 | 1 |

Cubeta 1/3

Bac 1/3 · GN-Behälter 1/3
Container 1/3 · Caixa 1/3

| Ref | € | h (cm) | L | U.Venta |
|--------|------|--------|------|---------|
| 66365H | 4,70 | 6,5 | 2,40 | 6 |
| 66310H | 5,60 | 10,0 | 3,80 | 6 |
| 66315H | 6,90 | 15,0 | 5,10 | 6 |
| 66320H | 8,40 | 20,0 | 6,90 | 6 |

1/4
265 x 162 mm



1/6
176 x 162 mm



1/9
176 x 108 mm



Cubeta 1/4

Bac 1/4 · GN-Behälter 1/4
Container 1/4 · Caixa 1/4

| Ref | € | h (cm) | L | U.Venta |
|--------|------|--------|------|---------|
| 66465H | 3,90 | 6,5 | 1,70 | 6 |
| 66410H | 5,20 | 10,0 | 2,40 | 6 |
| 66415H | 5,60 | 15,0 | 3,70 | 6 |

Cubeta 1/6

Bac 1/6 · GN-Behälter 1/6
Container 1/6 · Caixa 1/6

| Ref | € | h (cm) | L | U.Venta |
|--------|------|--------|------|---------|
| 66665H | 3,60 | 6,5 | 1,00 | 6 |
| 66610H | 3,80 | 10,0 | 1,60 | 6 |
| 66615H | 5,30 | 15,0 | 2,20 | 6 |

Cubeta 1/9

Bac 1/9 · GN-Behälter 1/9
Container 1/9 · Caixa 1/9

| Ref | € | h (cm) | L | U.Venta |
|--------|------|--------|------|---------|
| 66965H | 2,60 | 6,5 | 0,60 | 6 |
| 66910H | 3,60 | 10,0 | 0,90 | 6 |

Tapa

Couvercle · Deckel
Lid · Tampa

| Ref | € | Cubeta | U.Venta |
|---------|------|--------|---------|
| 66901DH | 8,50 | 1/1 | 6 |
| 66902DH | 5,00 | 1/2 | 6 |
| 66903DH | 3,70 | 1/3 | 6 |
| 66904DH | 3,10 | 1/4 | 6 |
| 66906DH | 2,20 | 1/6 | 6 |
| 66909DH | 2,00 | 1/9 | 6 |

Doble fondo perforado

Double fond perce · GN Einlege-Böden, gelocht
Punched double bottom · Duplo fundo perforado

| Ref | € | Cubeta | U.Venta |
|--------|------|--------|---------|
| 66911H | 9,80 | 1/1 | 10 |
| 66912H | 5,00 | 1/2 | 12 |
| 66913H | 2,90 | 1/3 | 12 |
| 66914H | 2,20 | 1/4 | 12 |
| 66916H | 1,60 | 1/6 | 12 |

Cubetas Melamina Black



- Fabricadas en melamina de alta calidad.
- Libres de BPA.
- Ligeras, indeformables y apilables.
- Higiénicas y fácilmente lavables.
- Aptas para procesos de refrigeración, congelación o distribución de alimentos.

- Fabriqué en mélamine de haute qualité.
- Sans BPA.
- Légères, indéformables et empilables.
- Hygiéniques et facilement lavables.
- Compatibles pour des processus de réfrigération, congélation ou distribution d'aliments.

- Made of high quality melamine.
- BPA free.
- Light, non-deformable and stackable.
- Hygienic and easily washable.
- Suitable for refrigeration and freezing processes and food distribution.

1/1
530 x 325 mm



Cubeta 1/1

Bac 1/1 · GN-Behälter 1/1
Container 1/1 · Caixa 1/1

| Ref | € | h(cm) | L | U.Venta |
|--------|-------|-------|-------|---------|
| 66165J | 48,30 | 6,5 | 8,50 | 1 |
| 66110J | 54,30 | 10 | 13,30 | 1 |

1/2
265 x 325 mm



Cubeta 1/2

Bac 1/2 · GN-Behälter 1/2
Container 1/2 · Caixa 1/2

| Ref | € | h(cm) | L | U.Venta |
|--------|-------|-------|------|---------|
| 66265J | 24,80 | 6,5 | 4,50 | 1 |
| 66210J | 27,90 | 10 | 8,00 | 1 |

1/3
176 x 325 mm



Cubeta 1/3

Bac 1/3 · GN-Behälter 1/3
Container 1/3 · Caixa 1/3

| Ref | € | h(cm) | L | U.Venta |
|--------|-------|-------|------|---------|
| 66365J | 19,80 | 6,5 | 2,50 | 1 |
| 66310J | 22,00 | 10 | 3,80 | 1 |

1/4
265 x 162 mm



Cubeta 1/4

Bac 1/4 · GN-Behälter 1/4
Container 1/4 · Caixa 1/4

| Ref | € | h(cm) | L | U.Venta |
|--------|-------|-------|------|---------|
| 66465J | 17,00 | 6,5 | 1,90 | 1 |
| 66410J | 19,10 | 10 | 2,50 | 1 |

2/3
350 x 325 mm



Cubeta 2/3

Bac 2/3 · GN-Behälter 2/3
Container 2/3 · Caixa 2/3

| Ref | € | h(cm) | L | U.Venta |
|--------|-------|-------|------|---------|
| 66565J | 35,70 | 6,5 | 5,50 | 1 |

1/6
176 x 162 mm



Cubeta 1/6

Bac 1/6 · GN-Behälter 1/6
Container 1/6 · Caixa 1/6

| Ref | € | h(cm) | L | U.Venta |
|--------|-------|-------|------|---------|
| 66665J | 12,10 | 6,5 | 1,10 | 1 |
| 66610J | 13,70 | 10 | 1,60 | 1 |

2/4
530 x 165 mm



Cubeta 2/4

Bac 2/4 · GN-Behälter 2/4
Container 2/4 · Caixa 2/4

| Ref | € | h(cm) | L | U.Venta |
|--------|-------|-------|------|---------|
| 66765J | 24,70 | 6,5 | 4,50 | 1 |

Cubetas Melamina White



- Fabricadas en melamina de alta calidad.
- Libres de BPA.
- Ligeras, indeformables y apilables.
- Higiénicas y fácilmente lavables.
- Aptas para procesos de refrigeración, congelación o distribución de alimentos.

- Fabriqué en mélamine de haute qualité.
- Sans BPA.
- Légères, indéformables et empilables.
- Hygiéniques et facilement lavables.
- Compatibles pour des processus de réfrigération, congélation ou distribution d'aliments.

- Made of high quality melamine.
- BPA free.
- Light, non-deformable and stackable.
- Hygienic and easily washable.
- Suitable for refrigeration and freezing processes and food distribution.

1/1
530 x 325 mm



Cubeta 1/1

Bac 1/1 · GN-Behälter 1/1
Container 1/1 · Caixa 1/1

| Ref | € | h(cm) | L | U.Venta |
|--------|-------|-------|-------|---------|
| 66165E | 45,40 | 6,5 | 8,50 | 1 |
| 66110E | 51,70 | 10,0 | 13,30 | 1 |

1/2
265 x 325 mm



Cubeta 1/2

Bac 1/2 · GN-Behälter 1/2
Container 1/2 · Caixa 1/2

| Ref | € | h(cm) | L | U.Venta |
|--------|-------|-------|------|---------|
| 66265E | 23,70 | 6,5 | 4,50 | 1 |
| 66210E | 26,30 | 10 | 8,00 | 1 |

1/3
176 x 325 mm



Cubeta 1/3

Bac 1/3 · GN-Behälter 1/3
Container 1/3 · Caixa 1/3

| Ref | € | h(cm) | L | U.Venta |
|--------|-------|-------|------|---------|
| 66365E | 18,50 | 6,5 | 2,50 | 1 |
| 66310E | 20,50 | 10 | 3,80 | 1 |

1/4
265 x 162 mm



Cubeta 1/4

Bac 1/4 · GN-Behälter 1/4
Container 1/4 · Caixa 1/4

| Ref | € | h(cm) | L | U.Venta |
|--------|-------|-------|------|---------|
| 66465E | 15,90 | 6,5 | 1,90 | 1 |
| 66410E | 17,90 | 10 | 2,50 | 1 |

2/3
350 x 325 mm



Cubeta 2/3

Bac 2/3 · GN-Behälter 2/3
Container 2/3 · Caixa 2/3

| Ref | € | h(cm) | L | U.Venta |
|--------|-------|-------|------|---------|
| 66565E | 34,20 | 6,5 | 5,50 | 1 |

1/6
176 x 162 mm



Cubeta 1/6

Bac 1/6 · GN-Behälter 1/6
Container 1/6 · Caixa 1/6

| Ref | € | h(cm) | L | U.Venta |
|--------|-------|-------|------|---------|
| 66665E | 11,40 | 6,5 | 1,10 | 1 |
| 66610E | 12,70 | 10 | 1,60 | 1 |

2/4
530 x 165 mm



Cubeta 2/4

Bac 2/4 · GN-Behälter 2/4
Container 2/4 · Caixa 2/4

| Ref | € | h(cm) | L | U.Venta |
|--------|-------|-------|------|---------|
| 66765E | 23,80 | 6,5 | 4,50 | 1 |

Transporte y almacenamiento

Transport and storage

Caja isotérmica y carros

EPP
Expanded Polypropylene



INOX

PP
Polypropylene



Totalmente plegables para ahorrar espacio.
Totally foldable to save space

Caja isotérmica Temple

PBoîte isotherme · Isothermische Box
Isothermal box · Caixa isotérmica

| | Ref | € | cm | h(cm) | L | U.Venta |
|---|-------|-------|-------|-------|------|---------|
| A | 66064 | 22,30 | 38x38 | 22 | 18,0 | 1 |
| B | 66066 | 38,20 | 60x40 | 25 | 38,5 | 1 |

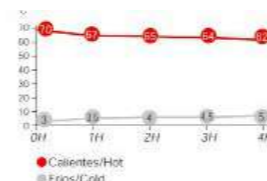

Termotrans

Thermotrans · Thermotrans
Thermotrans · Thermotrans

| | Ref | € | cm | L | U. Venta |
|---|-------|--------|--------------|----|----------|
| A | 66099 | 622,70 | 41x62x24 | 17 | 1 |
| B | 66299 | 666,70 | 41x62x37 | 34 | 1 |
| C | 66599 | 823,70 | 45x62,5x57,5 | 72 | 1 |



Entrega desmontado

Dismantled delivery



Carro servicio Basic
Chariot de service · Servierwagen
Service trolley · Carro serviço

| Ref | € | cm | U.Venta |
|-------|--------|--------------|---------|
| 66249 | 190,80 | 82x64,5x94,5 | 1 |

Entrega desmontado

Dismantled delivery



Carro servicio Desmontable
Chariot de service · Servierwagen
Service trolley · Carro serviço

| Ref | € | cm | U.Venta |
|-------|--------|--------------|---------|
| 66349 | 247,10 | 82x64,5x94,5 | 1 |

Entrega montado

Mounted delivery



Carro servicio soldado
Chariot de service · Servierwagen
Service trolley · Carro serviço soldado

| Ref | € | cm | U.Venta |
|-------|--------|--------------|---------|
| 66350 | 726,00 | 82x64,5x94,5 | 1 |

PE
Polyethylene

Carro servicio Black
Chariot de service · Servierwagen
Service trolley · Carro serviço

| Ref | € | cm | U.Venta |
|-------|--------|-----------|---------|
| 66353 | 271,40 | 103x49x95 | 1 |



Contenedor cubiertos

Bac plastique pour couverts · Besteckebehälter aus Plastik
Cutlery plastic bin · Recipiente de talheres plástico

| Ref | € | cm | L | U.Venta |
|-------|-------|----------|-----|---------|
| 66351 | 40,10 | 33x23x18 | 9 L | 1 |

Contenedor desperdicio

Bac à déchets plastique · Müllbehälter aus Plastik
Rubbish plastic bin · Recipiente de desperdícios em plástico

| Ref | € | cm | L | U.Venta |
|-------|-------|-----------|------|---------|
| 66352 | 66,90 | 33x284x56 | 30 L | 1 |



Pestillo de bloqueo
Locking tab



Fácil de plegar
Easy to fold



Carro servicio plegable

Chariot de servie pliable · Faltbarer servierwagen
Folding service cart · Carro de serviço dobrável

| Ref | € | cm | U.Venta |
|-------|--------|------------|---------|
| 66247 | 445,60 | 93x51x93,5 | 1 |



MAX: Ø30,5 cm
MIN: Ø19 cm
CAP: 360 units



PP

Polypropylene



190 Kg

Carro cortaplatos

Chariot porte-plateau · Tellerwagen
Dish cart · Carro porta-pratos

| Ref | € | cm | h(cm) | Capacidad | U.Venta |
|-------|---------|-------|-------|------------|---------|
| 66555 | 1376,70 | 96x71 | 81,0 | 360 platos | 1 |



Funda carro portaplatos

Housse chariot porte-plateau · Abdeckung für tellerwagen
Dish cart cover · Capa protectora carro porta-pratos

| Ref | € | cm | U.Venta |
|-------|-------|----------|---------|
| 62964 | 49,10 | 96x71x60 | 1 |

Ø tubo · tube: 1,7 cm

Separación entre tubos · Separation between tubes: 5 cm

INOX
18/10



Estante tubular inox

Étagère tubulaire en Inox · Rohrgestell-Regal, Rostfrei
St. steel tubular shelf · Prateleira tubular Inóx

| Ref | € | Medidas | U.Venta |
|-------|--------|------------------|---------|
| 56212 | 129,60 | 120 x 25 x 15 cm | 1 |
| 56216 | 141,20 | 160 x 25 x 15 cm | 1 |
| 56412 | 188,20 | 120 x 40 x 15 cm | 1 |
| 56416 | 201,50 | 160 x 40 x 15 cm | 1 |

Entrega desmontado

Dismantled delivery



INOX

Carro portabandejas

Chariot à glissières · Gestellwagen
Rack trolley · Carro porta-bandejas

| Ref | € | cm | Ancho (cm) | Medidas Cubeta | U.Venta |
|-------|---------|-----------|------------|----------------|---------|
| 66116 | 908,10 | 38x55x172 | 7,5 | GN 1/1 | 1 |
| 66118 | 1008,20 | 58x69x172 | 7,5 | GN 2/1 | 1 |
| 66642 | 849,60 | 45x62x172 | 6,0 | 60x40 | 1 |

Entrega montado

Mounted delivery

MAX: Ø28 cm
MIN: Ø8 cm
CAP: 100 units

INOX



Carro portaplatos con ruedas

Hors devoirs chariot · Tellertransportwagen
Stack trolley assembled · Carro porta-pratos com rodas

| Ref | € | cm | Capacidad | U.Venta |
|-------|---------|-----------|------------|---------|
| 66550 | 1739,80 | 70x70x195 | 100 platos | 1 |

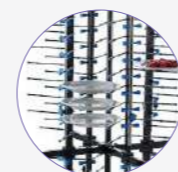
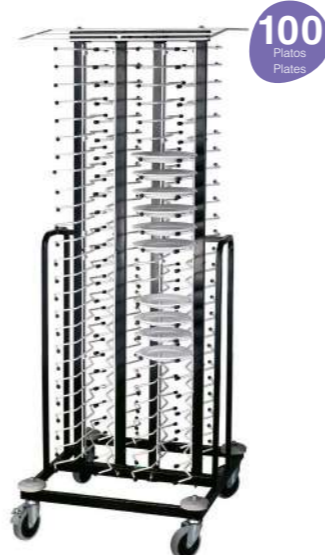

FE AL INOX
Iron Aluminium 18/10

Carro portaplatos

Chariot à plaques · Tellerwagen
Plate trolley · Carro de pratos

| Ref | € | cm | Capacidad | U.Venta |
|-------|--------|-------------|-----------|---------|
| 66551 | 865,70 | 58x58x174,5 | 80 platos | 1 |
| 66552 | 934,10 | 73x73x191 | 84 platos | 1 |

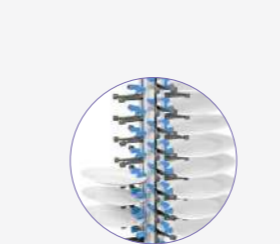

Detalle colocación platos

Detail of plate placement

AL
Aluminium

Soporte portaplatos

Support de plaque · Plattenhalter
Plate holder · Suporte de placas

| Ref | € | cm | Capacidad | U.Venta |
|-------|--------|-----------|-----------|---------|
| 66553 | 342,70 | 55x55x113 | 48 platos | 1 |



Detalle colocación platos

Detail of plate placement

Soporte platos pared

Support de plaque murale · Wandplattenhalter
Wall plate holder · Suporte de placa de parede

| Ref | € | cm | Capacidad | U.Venta |
|-------|--------|-------------|-----------|---------|
| 66556 | 167,90 | 12x10x81 | 9 platos | 1 |
| 66557 | 191,80 | 12x10x101,5 | 12 platos | 1 |



48
Platos
Plates



9-12
Platos
Plates



- Ideal para hostelería, restaurantes, bares, cocinas, catering, hoteles, etc.
- Solución eficiente y práctica para el proceso de emplatado.
- Versátil; su sistema de sujeción permite adecuar diferentes tamaños y formas.
- Platos compatibles de Ø15-Ø32cm. Bandejas de hasta 32 cm de longitud.
- La sujeción es extremadamente firme evitando deslizamientos y roturas.
- Apila de forma cómoda y sencilla gran cantidad de platos. Capacidad para 80-84 platos.
- Estructura de hierro con un acabado pintado en negro.
- Soporte intermedio para un mejor manejo y transporte.
- Fácil de transportar. 4 ruedas giratorias, 2 de ellas con freno.
- Se suministra desmontado.

- Ideal for the catering, restaurants, bars, kitchens, catering, hotels, etc.
- Efficient and practical solution for the plating process.
- Versatile; its fastening system allows to adapt different sizes and shapes.
- Compatible plates from Ø15-Ø32cm. Trays up to 32 cm in length.
- Extremely firm clamping system prevents slipping and breakage.
- Stacks easily and comfortably a large number of plates. Capacity for 80-84 plates.
- Iron structure with black painted finish.
- Intermediate support for better handling and transport.
- Easy to transport. 4 swivel wheels, 2 of them with brakes.
- Supplied disassembled.

- Ideal para hostelería, restaurantes, bares, cocinas, catering, hoteles, etc.
- Solución eficiente y práctica para el proceso de emplatado.
- Base sólida que asegura la estabilidad del soporte, evitando caídas y asegurando un manejo seguro de los platos.
- Regulable en cada columna independientemente, para ajustarse a la altura del plato consiguiendo una perfecta sujeción.
- Fácil de transportar.
- Platos compatibles de Ø10 - Ø32 cm. Bandejas de hasta 32 cm de longitud.
- Permite apilar de forma cómoda y sencilla gran cantidad de platos.
- Capacidad para 48 platos.
- Se suministra desmontado.

- Ideal for catering, restaurants, bars, kitchens, catering, hotels, etc.
- Efficient and practical solution for the plating process.
- Solid base that ensures the stability of the support, avoiding falls and ensuring safe handling of the plates.
- Independently adjustable on each column, to adjust to the height of the plate, achieving a perfect hold.
- Easy to transport.
- Compatible plates from Ø10 - Ø32 cm. Trays up to 32 cm in length.
- Allows a large number of plates to be stacked easily and conveniently.
- Capacity for 48 plates.
- Supplied disassembled.

- Ideal para hostelería, restaurantes, bares, cocinas, catering, hoteles, etc.
- Solución eficiente y práctica para el proceso de emplatado.
- Estable y seguro. Ahorra espacio.
- Ajuste de altura de platos mediante regulador superior de rosca.
- La sujeción es extremadamente firme evitando deslizamientos y roturas.
- Fijación en pared mediante tornillería (incluida), permite un aprovechamiento óptimo del espacio
- Platos compatibles de Ø10 - Ø32 cm. Bandejas de hasta 32 cm de longitud.
- Capacidad para 9 platos.

- Idéal pour la restauration, les restaurants, les bars, les cuisines, la restauration, les hôtels, etc.
- Solution efficace et pratique pour le processus de placage.
- Stable et sûr. Peu encombrant.
- Réglage de la hauteur des assiettes à l'aide d'une vis de réglage.
- Fixation extrêmement solide pour éviter les glissements et les cassures.
- Fixation murale à l'aide de vis (incluses), permettant une utilisation optimale de l'espace.
- Plaques compatibles de Ø10 à Ø32 cm. Plateaux jusqu'à 32 cm de long.
- Capacité de 9 assiettes.

- Ideal for catering, restaurants, bars, kitchens, catering, hotels, etc.
- Efficient and practical solution for the plating process.
- Stable and safe. Space saving.
- Height adjustment of plates by means of screw top adjuster.
- Extremely firm fixing to prevent slipping and breakage.
- Wall mounting by means of screws (included), allowing optimum use of space.
- Compatible plates from Ø10 - Ø32 cm. Trays up to 32 cm long.
- Capacity for 9 plates.

Bandejas autoservicios



- Ideal para diferentes colectivos como buffets, self-service, hospitales, colegios, guarderías, campamentos, etc.
- Compartimentos para alimentos y para cubiertos.
- Higiénicas, fáciles de recoger, limpiar y guardar; ocupan poco espacio.
- Apilables.

- Idéal pour différents groupes tels que buffets, self-service, hôpitaux, écoles, crèches, camps, etc.
- Compartiments pour les aliments et pour les couverts.
- Hygiénique, faciles à collecter, nettoyer et ranger; il prend peu de place.
- Empilable.

- Ideal for different groups such as buffets, self-service, hospitals, schools, nurseries, camps, etc.
- Compartments for food and for cutlery.
- Hygienic, easy to collect, clean and store; it takes up little space.
- Stackable.



Asas de silicona
Silicone handles

5 compartimentos
5 compartments

INOX 18/10 INOX SI
Silicone

Bandeja autoservicio Inox

Plateau libre-service · Selbstbedienungstablett
Self-service tray · Bandeja self-service

| Ref | € | Material | cm | h(cm) | U.Venta |
|---------|-------|------------|-----------|-------|---------|
| 66957 | 26,40 | Inox 18/10 | 32,5x37,5 | 3,6 | 1 |
| 66957Z | 22,10 | Inox | 32,5x37,5 | 3,6 | 1 |
| R66957A | 0,80 | Silicona | - | - | 1 |

Tapa apta para bandejas polipropileno

Lid suitable for polypropylene trays



Tapa apta para bandejas policarbonato

Lid suitable for polycarbonate trays



Tapa para bandeja autoservicio

Couvercle pour plateau self-service · Deckel für Selbstbedienung Tablett
Lid for self-service tray · Tampa para bandeja auto-serviço

| Ref | € | Material | cm | U.Venta |
|---------|-------|---------------|-------|---------|
| A 66960 | 14,70 | Polypropylene | 53x37 | 1 |
| B 66962 | 19,30 | Polycarbonate | 53x37 | 1 |

La misma bandeja sirve como tapa

The same tray serves as a lid

PP PC
Polypropylene Polycarbonate

Bandeja autoservicio

Plateau self-service · Selbstbedienung Tablett
Self-service tray · Bandeja auto-serviço

| Ref | € | Material | cm | U.Venta |
|---------|-------|---------------|-------|---------|
| A 66952 | 20,00 | Polycarbonate | 33x33 | 1 |
| B 66951 | 12,20 | Polypropylene | 33x33 | 1 |
| C 66961 | 20,30 | Polycarbonate | 33x33 | 1 |

PP
Polypropylene

Bandeja servicio Basic

Plateau rectangulaire · Tablet, rechtecking
Rectangular tray · Bandeja de servir

| Ref | € | cm | U.Venta |
|-------|-------|-------|---------|
| 66953 | 17,90 | 53x37 | 1 |



Bandeja Servicio Red

Plateau de service · Serviertablett
Serving tray · Bandeja de servir

| Ref | € | cm | U.Venta |
|-------|------|-----------|---------|
| 66990 | 5,10 | 35x27 | 1 |
| 66991 | 6,10 | 41,5x30,5 | 1 |
| 66992 | 7,00 | 45x35 | 1 |



Bandeja Servicio Blue

Plateau de service · Serviertablett
Serving tray · Bandeja de servir

| Ref | € | cm | U.Venta |
|-------|------|-----------|---------|
| 66993 | 5,10 | 35x27 | 1 |
| 66994 | 6,10 | 41,5x30,5 | 1 |
| 66995 | 7,00 | 45x35 | 1 |



Bandeja Servicio Cream

Plateau de service · Serviertablett
Serving tray · Bandeja de servir

| Ref | € | cm | U.Venta |
|-------|------|-----------|---------|
| 66996 | 5,10 | 35x27 | 1 |
| 66997 | 6,10 | 41,5x30,5 | 1 |
| 66998 | 7,00 | 45x35 | 1 |



Superficie anti-deslizante y anti-rayado
Anti-slip and anti-scratch surface



100% libres de BPA



Propiedades anti-bacterianas

- Bandejas diseñadas para el sector profesional, especialmente Catering y FastFood.
- Fabricadas en polipropileno, 100% libres de BPA.
- Ligeras, resistentes, apilables y reciclables.
- Superficie anti-deslizante y anti-rayado, diseñadas para uso intensivo.
- Propiedades anti-bacterianas.
- Aptas para lavavajillas.
- 3 colores disponibles: rojo/azul/cream.
- 3 tamaños disponibles.

- Plateaux conçus pour le secteur professionnel, en particulier pour la restauration collective et la restauration rapide.
- Fabriqués en polypropylène, 100% sans BPA.
- Légers, résistants, empilables et recyclables.
- Surface antidérapante et anti-rayures, conçue pour un usage intensif.
- Propriétés antibactériennes.
- Passe au lave-vaisselle.
- 3 couleurs disponibles : rouge/bleu/ crème.
- 3 tailles disponibles.

- Trays designed for the professional sector, especially Catering and FastFood.
- Made of polypropylene, 100% BPA free.
- Lightweight, resistant, stackable and recyclable.
- Anti-slip and anti-scratch surface, designed for intensive use.
- Anti-bacterial properties.
- Dishwasher safe.
- 3 colours available: red/blue/cream.
- 3 sizes available.

Bandejas Isotérmicas

PC Polycarbonate
100°C Max
Microwave Oven Dishwasher
BPA free

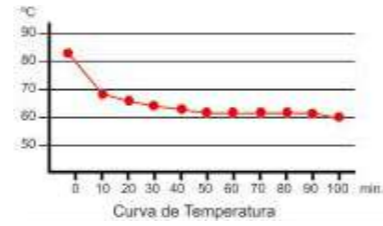

COMPOSICIÓN:
66930 - Bandeja isotérmica B-1
66933 - Plato llano con tapa
66934 - Plato hondo con tapa
66937 - Bol con tapa
66959 - Bol rectangular con tapa
66956 - Cierre portafichas hermético



Bandeja isotérmica B1

Plateau Isotherme B-1 · Isothermal Schale/Tablett B-1
Isothermal B-1, Tray · Bandeja isotérmica B-1

| Ref | € | cm | U.Venta |
|-------|--------|------------|---------|
| 66930 | 211,90 | 53x36,5x11 | 1 |



Set completo bandeja isotérmica B1

Set complet B-1 · Komplet-Set B-1
Complete set B-1 · Conjunto completo bandeja isotérmica B-1

| Ref | € | cm | U.Venta |
|-------|--------|---------|---------|
| 66942 | 246,10 | 53x36,5 | 1 |



Plato llano con tapa

Assiette plate polycarbonate avec couvercle · Grosser Teller, Polycarbonat mit deckel
Polycarbonate dinner plate with lid · Prato raso polycarbonato com tampa

| Ref | € | cm | U.Venta |
|--------|-------|-------|---------|
| 66933 | 15,80 | Ø22x3 | 1 |
| 66933C | 11,20 | - | 1 |
| 66940 | 4,70 | - | 1 |

Conjunto · Set

Plato · Platte

Tapa · Lid



Plato hondo con tapa

Assiette creuse polycarbonate a/couvercle · Suppenteller, Polycarbonat mit deckel
Polycarbonate sopper plate with lid · Prato fundo polycarbonato com tampa

| Ref | € | cm | ml | U.Venta |
|--------|-------|-------|-----|---------|
| 66934 | 10,40 | Ø19x5 | 450 | 1 |
| 66934C | 5,90 | - | 450 | 1 |
| 66939 | 4,50 | - | - | 1 |

Conjunto · Set

Plato · Platte

Tapa · Lid



Bol con tapa

Bol polycarbonate avec couvercle · Schüssel, Polycarbonat mit deckel
Polycarbonate bowl with lid · Tijela polycarbonato com tampa

| Ref | € | cm | ml | U.Venta |
|--------|------|---------|-----|---------|
| 66937 | 6,80 | Ø13x6,5 | 450 | 1 |
| 66937C | 5,20 | - | 450 | 1 |
| 66938 | 1,50 | - | - | 1 |

Conjunto · Set

Taza · Cup

Tapa · Lid

Bol doble pared con tapa

Bol isotherme polycarb. a/couvercle · Polycarbonat Schüssel, Isothermal mit Deckel
Double wall polycarbonate bowl w/lid · Tijela parede dupla polycarbonato c/ tampa

| Ref | € | Ø (cm) | ml | U.Venta |
|--------|-------|--------|-----|---------|
| 66948 | 14,30 | 12,5x7 | 500 | 1 |
| 66948S | 12,80 | 12,5x7 | 500 | 1 |
| 66938 | 1,50 | 12,5 | - | 1 |

Conjunto · Set

Taza · Cup

Tapa · Lid



Taza desayuno con tapa

Coupelle dessert polycarbonate a/couvercle · Frühstückstasse Polycarbonat m/Deckel
Polycarbonate breakfast cup w/lid · Chávena pequeno-almoço com tampa

| Ref | € | Ø (cm) | ml | U.Venta |
|--------|------|--------|-----|---------|
| 66936 | 5,30 | 9x7 | 300 | 1 |
| 66936C | 4,10 | 9x7 | 300 | 1 |
| 66936T | 1,20 | 9 | - | 1 |

Conjunto · Set

Taza · Cup

Tapa · Lid



Vaso

Verre polycarbonate · Glas, Polycarbonat
Polycarbonate glass · Copo polycarbonato

| Ref | € | Ø (cm) | ml | U.Venta |
|-------|------|---------|-----|---------|
| 66947 | 2,40 | 7x10 | 250 | 1 |
| 66932 | 3,30 | 8,3x9,5 | 300 | 12 |



Tapa cubreplatos redondo

Couvercle pour assiettes Polycarbonate · Polycarbonat Teller-Abdeckung
Polycarbonate round plat cover · Tampa cobre-pratos redonda polycarbonato

| Ref | € | Ø (cm) | U.Venta |
|-------|-------|--------|---------|
| 66950 | 12,30 | 25x7 | 1 |



Plato desayuno

Assiette dessert polycarbonate · Frühstücksteller, Polycarbonat
Polycarbonate breakfast plate · Prato de pequeno-almoço polycarbonato

| Ref | € | cm | U.Venta |
|-------|------|---------|---------|
| 66935 | 5,00 | Ø18x2,5 | 1 |



Jarra

Pot verser polycarbonate · Krug, Polycarbonat
Polycarbonate jug · Jarra polycarbonato

| Ref | € | L | U.Venta |
|--------|-------|------|---------|
| 66945 | 12,40 | 1,00 | 1 |
| 66945S | 9,40 | 1,00 | 1 |
| 66945T | 2,90 | - | 1 |

Conjunto · Set

Jarra · Jug

Tapa · Lid



Carro portabandejas

Chariot plateaux · Wagen für Schale/Tablett
Isothermal tray trolley · Carro porta-bandejas

| Ref | € | cm | Capacidad | U.Venta |
|-------|---------|-----------|-------------|---------|
| 66931 | 3267,30 | 90x62x148 | 20 bandejas | 1 |

Estanterías

AL
Aluminium

- Las estanterías modulares LACOR no precisan para su montaje/desmontaje de herramienta alguna, son fáciles de montar, robustas y ligeras.
- Construidas en materiales de alta calidad garantizan una larga duración, además de adecuarse al uso alimenticio en cámaras refrigeradas. La construcción modular permite al cliente adecuarse a la longitud y espacios disponibles, pudiendo ampliar y modificar la distribución en cualquier momento.
- Diseñadas para poder emplear cubetas GASTRONORM 2/1, 1/1 y 2/3, con dos anchuras de fondo disponibles, 560 mm y 385 mm.
- La distribución de los estantes permite el máximo aprovechamiento de la altura disponible, con un máximo de 11 estantes en altura 1750 mm y 12 estantes en altura de 2000 mm, con un peso máximo aproximado por estantería de 1.200 Kg. Con una altura útil mínima de 100 mm es especialmente recomendada para el almacenaje de medicamentos, artículos de ferretería o alimentos en conserva.
- Las distintas alturas de los estantes y su fácil montaje/desmontaje, permite que las distancias entre estantes puedan variarse a razón de 150 mm adicionales a los 100 mm iniciales (100mm/250mm/400mm/550mm)

- Les étagères modulaires LACOR ne nécessitent aucun outil pour leur montage/démontage. Elles sont faciles à monter, robustes et légères.
- Elles sont construites dans des matériaux d'une grande qualité qui garantissent une longue durée de vie, et s'adaptent à une utilisation alimentaire dans les chambres froides.
- La construction modulaire permet au client de les adapter à la longueur et aux espaces disponibles, avec la possibilité d'agrandir ou de modifier la distribution à tout moment.
- Conçues pour l'emploi de bacs GASTRONORM 2/1, 1/1 et 2/3, avec deux largeurs de fond disponibles, 560 mm et 385 mm L'agencement des étagères permet de profiter au maximum de la hauteur disponible, avec un nombre limite de 11 étagères en hauteur de 1750 mm et de 12 étagères en hauteur de 2000 mm, pour un poids maximum d'environ 1.200 Kg par étagère. Avec une hauteur utile minimale de 100 mm, elle est spécialement conseillée pour stocker des médicaments, des articles de quincaillerie ou des aliments en conserve.
- Les différentes hauteurs des étagères et leur facilité de montage/démontage permettent de varier la distance entre étagères de 150 mm supplémentaires par rapport aux 100 mm d'origine (100mm/250mm/400mm/550mm).

- No tools are required in the assembly/disassembly of LACOR modular shelving; they are easy to assemble, robust and light.
- Built in top-quality material, they are guaranteed to be long-lasting, and also apt for storing food in refrigerators.
- Their modular construction allows the client to fit them lengthwise into the available space, being able to expand and modify their distribution at anytime.
- Designed for use with GASTRONORM 2/1, 1/1 and 2/3 trays, with two available depths, 560mm and 385mm The shelves' distribution allows for maximum use of available height, with a maximum height of 11 shelves at 1750mm and 12 shelves 2000mm, with an approximate maximum weight of 1,200kg per shelf.
- With a minimum height of 100mm, it's especially recommended for storing medicine, tools or canned foods.
- The different shelf heights and easy assembly / disassembly make it so the distances between shelves can vary by 150mm from the initial 100mm (100mm/250mm/400mm/550mm).

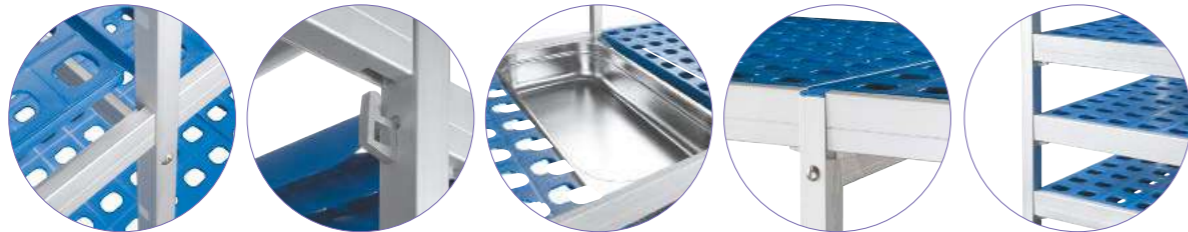

Capacidad por estante
Capacity per shelf
Distribuir el peso uniformemente
Distributing the weight evenly

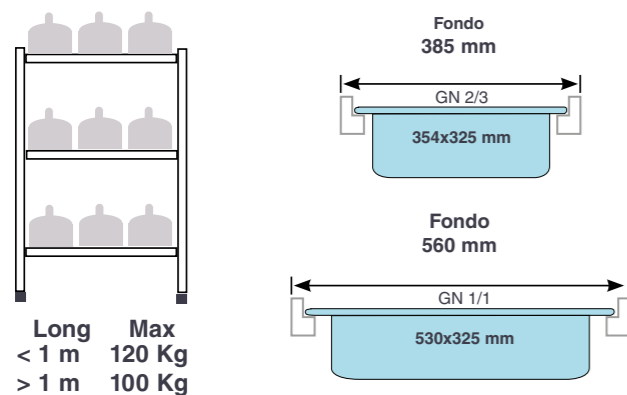

Instrucciones montaje

Las estanterías LACOR no precisan de herramienta alguna para su montaje o desmontaje; siga estas instrucciones para poder realizar el montaje de una estantería simple. En caso de precisar cualquier aclaración o información adicional, no dude en ponerse en contacto con su suministrador o visite nuestra página web.

- Extraiga todos los componentes de su embalaje original, no se deshaga de este hasta comprobar que el artículo se encuentra completo. Coloque todos los componentes en el suelo.
- Disponga de un espacio libre, ampliamente superior a las dimensiones de la estantería a montar.
- Tome un soporte lateral extendido en el suelo, introduzca 2 ganchos en los orificios más bajos que vaya a emplear, tal y como muestra la figura 1. Apoye este soporte lateral contra la pared.
- Tome el otro soporte lateral e introduzca los ganchos en los mismos orificios. Coloque ahora los 2 largueros de la parte inferior (figura 2).
- Coloque de pie este soporte lateral y aproxímese al soporte lateral apoyado contra la pared, introduzca los largueros en los ganchos de éste, la estantería quedará estabilizada (figura 3). Asegúrese de que los largueros han sido correctamente colocados.
- Ahora puede seleccionar las diferentes alturas a las cuales colocará los ganchos y largueros de los estantes (figura 4).
- Antes de colocar las parrillas plásticas, asegúrese de que todos los largueros se encuentran correctamente colocados.
- Montaje guía ángulo:
 - Retire todas las parrillas plásticas y extraiga uno de los largueros de la estantería.
 - Introduzca 2 ganchos de ángulo en la barra ángulo tal y como muestra la figura (figura 6 y 7).
NOTA: deberá emplear tantas barras ángulo como estantes disponga (figura 5).
 - Introduzca el larguero por la barra ángulo con los ganchos laterales (figura 8).
 - Ahora coloque el larguero con las barras ángulo en su anterior ubicación. Realice el mismo proceso con todos los largueros de uno de los laterales.
 - Una vez terminado, asegúrese de colocar todas las barras ángulo contra el mismo extremo, ahora realice el montaje de los 2 largueros de la parte inferior (figura 9).
 - Coloque en el nuevo soporte lateral 2 ganchos a la misma altura que la estantería ya montada.
 - Monte el nuevo soporte lateral a los largueros que forman el ángulo (figura 9); asegúrese de introducirlos correctamente.
 - Ahora ya puede montar el resto de largueros hasta finalizar el montaje.
 - Antes de colocar las parrillas plásticas, asegúrese de que todos los largueros se encuentran correctamente colocados
NOTA: las patas pueden regularse en altura 1 cm para absorber irregularidades del suelo, emplee una llave inglesa o fija de 17 mm

Mounting instructions

The LACOR shelves do not need any tool whatsoever to be assembled or dismantled. Follow these instructions to be able to assemble one single shelf. If you need any further explanation or information, do not hesitate to contact your supplier or visit our website.

- Take all the components out of their original wrapping. Do not throw the wrapping away until you have checked that the article is complete. Place all the components on the floor.
- Make a space available that is much larger than the shelf to be assembled.
- Take a side support lying on the floor and put two hooks into the lowest holes you are going to use, as shown in figure 1. Lean this support against the wall.
- Take the other side support and put the hooks into the same holes. Now place the 2 lower rods (figure 2).
- Stand this side support up and bring it next to the side support leaning against the wall. Put the rod lengths into its hooks. The shelf will remain stabilized (figure 3). Make sure the rod lengths have been properly placed.
- Now you can select the different heights at which you will place the hooks and the shelf rod lengths (figure 4).
- Before placing the plastic racks, make sure that all the rods are properly in place.
- Assembly of angle guide rail:
 - Remove all the plastic racks and take out one of the shelf rod lengths.
 - Put 2 angle hooks into the angle bar as shown (figure 6 and Figure 7).
NOTE: you must use as many angle bars as the number of shelves you have (figure 5).
 - Put the rod length through the angle bar with the side hooks (figure 8).
 - Now place the rod length with the angle bars in its previous place. Follow the same process with all the rod lengths of one of the sides.
 - Once finished, make sure you place all the angle bars against the same end. Now assemble the 2 lower rod lengths (figure 9).
 - Place 2 hooks on the new side support at the same height as the shelf assembled.
 - Mount the new side support onto the rod lengths that form the angle (figure 9). Make sure you introduce them properly.
 - Now you can assemble the rest of the rod lengths until you finish the assembly.
 - Before placing the plastic racks, make sure that all the rod lengths are properly placed.
NOTE: the legs can be adjusted by 1 cm in height to absorb unevenness in the floor. Use an adjustable or 17 mm fixed spanner.

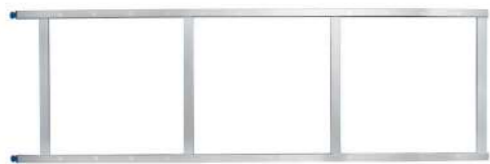

AL
Aluminium

Soporte lateral

Support latérale · Seitenständer
Lateral support · Suporte lateral

| 385 mm (GN 2/3) | 560 mm (GN 1/1) |
|-----------------|-----------------|
| Fondo / Width | Fondo / Width |

| Ref | € | Ref | € | h (cm) |
|-------|--------|-------|--------|--------|
| 56302 | 33,30 | 57302 | 37,40 | 25 |
| 56317 | 91,10 | 57317 | 98,60 | 175 |
| 56320 | 106,50 | 57320 | 113,80 | 200 |



AL
Aluminium

Set ángulo 90°

Jeu angle 90° · Eckesatz 90°
90° corner set · Conjunto ângulo 90°

| Ref | € | L (mm) | U.Venta |
|-------|-------|--------|---------|
| 56330 | 15,70 | 385 | 1 |
| 57330 | 20,10 | 560 | 1 |



AL PP
Aluminium Polypropylene BPA free

Rueda para estantería

Rove pour étagère · Rad für Regal
Shelf wheel · Roda para prateleira

| Ref | € | U.Venta |
|---------|-------|---------|
| A 56522 | 46,50 | 1 |
| B 56523 | 63,20 | 1 |

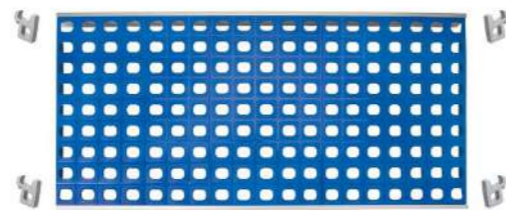

AL PP
Aluminium Polypropylene BPA free

Estantería completa

Rayonnage complet · Regale, komplett
Full shelving · Estantes completa

| 385 mm (GN 2/3) | 560 mm (GN 1/1) |
|-----------------|-----------------|
| Fondo / Width | Fondo / Width |

| Ref | € | Ref | € | L (mm) | U.Venta |
|-------|-------|-------|--------|--------|---------|
| 56007 | 47,80 | 57007 | 56,30 | 710 | 1 |
| 56008 | 50,70 | 57008 | 59,40 | 820 | 1 |
| 56009 | 56,30 | 57009 | 64,50 | 930 | 1 |
| 56010 | 64,50 | 57010 | 76,60 | 1035 | 1 |
| 56011 | 69,80 | 57011 | 81,70 | 1145 | 1 |
| 56012 | 74,00 | 57012 | 87,00 | 1255 | 1 |
| 56013 | 76,60 | 57013 | 91,90 | 1365 | 1 |
| 56014 | 87,00 | 57014 | 101,50 | 1470 | 1 |
| 56015 | 89,50 | 57015 | 107,30 | 1580 | 1 |



AL
Aluminium

Barra soporte lateral

Barre support latérale · Seitenständer stange
Lateral support bar · Barra soporte lateral

| Ref | € | h (mm) | U.Venta |
|-------|-------|--------|---------|
| 56502 | 9,30 | 250 | 1 |
| 56517 | 33,10 | 1750 | 1 |
| 56520 | 36,40 | 2000 | 1 |

AL
Aluminium

Travesaño soporte lateral

Longeron support latérale · Seitenständer traverse
Lateral support crossbar · Travesaño soporte lateral

| Ref | € | L (mm) | U.Venta |
|-------|------|--------|---------|
| 56321 | 5,60 | 385 | 1 |
| 57321 | 8,20 | 560 | 1 |



AL
Aluminium BPA free

Travesaño

Longeron · Traverse
Crossbar · Travesano

| Ref | € | L (mm) | U.Venta |
|-------|-------|--------|---------|
| 56507 | 14,50 | 654 | 1 |
| 56508 | 15,40 | 766 | 1 |
| 56509 | 17,70 | 876 | 1 |
| 56510 | 19,30 | 981 | 1 |
| 56511 | 20,80 | 1091 | 1 |
| 56512 | 22,40 | 1201 | 1 |
| 56513 | 23,80 | 1311 | 1 |
| 56514 | 25,40 | 1416 | 1 |
| 56515 | 26,30 | 1526 | 1 |

AL
Aluminium

Juego 4 ganchos

Jeu 4 crochet pour l'angle · 4 Satz Haken für ecke
4 pcs. set corner hooks · Jogo 4 ganchos ângulo

| Ref | € | U.Venta |
|-------|------|---------|
| 56527 | 2,50 | 1 |

Travesaño · Crossbar



Barra · Bar

PP
Polypropylene

Parrilla

Clayete en polyéthilène · Polyethylen Boden/Raster
Polyethylene rack · Grelha polietileno

| Ref | € | mm | U.Venta |
|-------|-------|---------|---------|
| 56325 | 7,40 | 353x325 | 1 |
| 56435 | 8,50 | 353x425 | 3 |
| 57325 | 11,40 | 530x325 | 1 |
| 57435 | 14,00 | 530x435 | 1 |

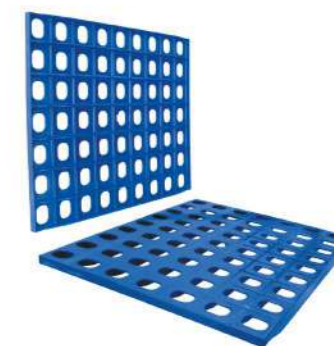

AL
Aluminium

Set ángulo 90° Rep.

Jeu angle 90° · Eckesatz 90°
90° corner set · Conjunto ângulo 90°

| Ref | € | L (mm) | U.Venta |
|-------|-------|--------|---------|
| 56322 | 14,70 | 385 | 1 |
| 57322 | 19,00 | 560 | 1 |

AL
Aluminium

Jgo. 4 ganchos travesaño

Jeu 4 crochet pour longeron · 4 Satz Haken für traverse
4 pcs. crossbar hooks · Jogo 4 ganchos travesano

| Ref | € | U.Venta |
|-------|------|---------|
| 56524 | 3,10 | 1 |



INOX
18/10

Juego 6 tornillos

Jeu 6 vis en Inox · 6 Satz schrauben
6 pcs. set screws · Jogo 6 parafusos

| Ref | € | U.Venta |
|-------|------|---------|
| 56526 | 2,30 | 1 |



PP
Polypropylene

Jgo. 2 pie nivelación

Jeu 2 pied nivellement · 2 Satz niveau füsse
26 pcs. set level foot · Jogo pé nivelamento

| Ref | € | U.Venta |
|-------|------|---------|
| 56525 | 4,90 | 1 |



385x250 mm

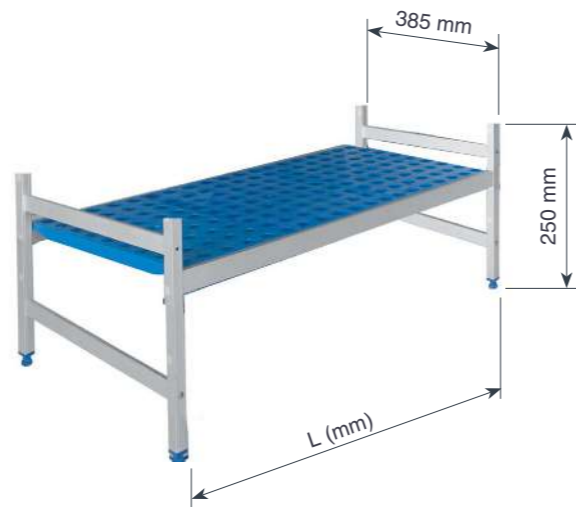

Bancada completa

Banc complet · Bank, komplett
Complete bench · Banco completo

1 Estante · Shelf

| Ref | € | L (mm) | Desglose |
|-------|--------|--------|-----------------------|
| 55400 | 115,60 | 710 | 56302 x 2 / 56007 x 1 |
| 55401 | 118,10 | 822 | 56302 x 2 / 56008 x 1 |
| 55402 | 123,30 | 932 | 56302 x 2 / 56009 x 1 |
| 55403 | 131,00 | 1037 | 56302 x 2 / 56010 x 1 |
| 55404 | 136,20 | 1147 | 56302 x 2 / 56011 x 1 |
| 55405 | 140,50 | 1257 | 56302 x 2 / 56012 x 1 |
| 55406 | 143,00 | 1367 | 56302 x 2 / 56013 x 1 |
| 55407 | 153,40 | 1472 | 56302 x 2 / 56014 x 1 |
| 55408 | 155,80 | 1582 | 56302 x 2 / 56015 x 1 |

560x250 mm

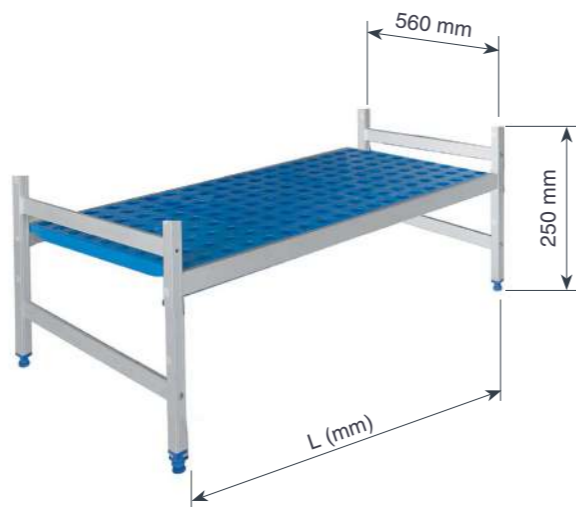

Bancada completa

Banc complet · Bank, komplett
Complete bench · Banco completo

1 Estante · Shelf

| Ref | € | L (mm) | Desglose |
|-------|--------|--------|-----------------------|
| 55700 | 131,40 | 710 | 57302 x 2 / 57007 x 1 |
| 55701 | 134,10 | 822 | 57302 x 2 / 57008 x 1 |
| 55702 | 139,20 | 932 | 57302 x 2 / 57009 x 1 |
| 55703 | 151,30 | 1037 | 57302 x 2 / 57010 x 1 |
| 55704 | 156,50 | 1147 | 57302 x 2 / 57011 x 1 |
| 55705 | 161,70 | 1257 | 57302 x 2 / 57012 x 1 |
| 55706 | 166,40 | 1367 | 57302 x 2 / 57013 x 1 |
| 55707 | 176,80 | 1472 | 57302 x 2 / 57014 x 1 |
| 55708 | 181,70 | 1582 | 57302 x 2 / 57015 x 1 |

385x1750 mm



Estantería completa

Rayonnage complet · Regale, komplett
Full shelving · Estantes completa

3 Estantes · Shelf

4 Estantes · Shelf

5 Estantes · Shelf

| SIMPLE | Ref | € | L (mm) | Desglose | Ref | € | Desglose | Ref | € | Desglose |
|--------|--------|--------|-----------------------|-----------------------|--------|-----------------------|-----------------------|--------|-----------------------|-----------------------|
| | 55409 | 329,30 | 710 | 56317 x 2 + 56007 x 3 | 55446 | 377,40 | 56317 x 2 + 56007 x 4 | 55483 | 426,90 | 56317 x 2 + 56007 x 5 |
| 55410 | 337,30 | 822 | 56317 x 2 + 56008 x 3 | 55447 | 389,10 | 56317 x 2 + 56008 x 4 | 55484 | 439,60 | 56317 x 2 + 56008 x 5 | |
| 55411 | 352,80 | 932 | 56317 x 2 + 56009 x 3 | 55448 | 408,40 | 56317 x 2 + 56009 x 4 | 55485 | 466,10 | 56317 x 2 + 56009 x 5 | |
| 55412 | 375,80 | 1037 | 56317 x 2 + 56010 x 3 | 55449 | 439,60 | 56317 x 2 + 56010 x 4 | 55486 | 504,80 | 56317 x 2 + 56010 x 5 | |
| 55413 | 390,20 | 1147 | 56317 x 2 + 56011 x 3 | 55450 | 460,50 | 56317 x 2 + 56011 x 4 | 55487 | 530,90 | 56317 x 2 + 56011 x 5 | |
| 55414 | 404,70 | 1257 | 56317 x 2 + 56012 x 3 | 55451 | 478,60 | 56317 x 2 + 56012 x 4 | 55488 | 552,80 | 56317 x 2 + 56012 x 5 | |
| 55415 | 411,40 | 1367 | 56317 x 2 + 56013 x 3 | 55452 | 488,80 | 56317 x 2 + 56013 x 4 | 55489 | 554,30 | 56317 x 2 + 56013 x 5 | |
| 55416 | 443,00 | 1472 | 56317 x 2 + 56014 x 3 | 55453 | 529,90 | 56317 x 2 + 56014 x 4 | 55490 | 604,80 | 56317 x 2 + 56014 x 5 | |
| 55417 | 449,40 | 1582 | 56317 x 2 + 56015 x 3 | 55454 | 540,20 | 56317 x 2 + 56015 x 4 | 55491 | 617,30 | 56317 x 2 + 56015 x 5 | |

| DOBLE · DOUBLE | Ref | € | L (mm) | Desglose | Ref | € | Desglose | Ref | € | Desglose |
|----------------|--------|--------|-------------------------------|-------------------------------|--------|---------------------------------|-------------------------------|---------|---------------------------------|-------------------------------|
| | 55418 | 614,10 | 1719 | 56317 x 3 + 56007 x 3 + 56010 | 55455 | 727,70 | 56317 x 3 + 56007 x 4 + 56010 | 55492 | 841,20 | 56317 x 3 + 56007 x 5 + 56010 |
| 55419 | 629,80 | 1829 | 56317 x 3 + 56007 x 3 + 56011 | 55456 | 747,90 | 56317 x 3 + 56007 x 4 + 56011 | 55493 | 867,30 | 56317 x 3 + 56007 x 5 + 56011 | |
| 55420 | 642,90 | 1939 | 56317 x 3 + 56007 x 3 + 56012 | 55457 | 765,00 | 56317 x 3 + 56007 x 4 + 56012 | 55494 | 888,90 | 56317 x 3 + 56007 x 5 + 56012 | |
| 55421 | 660,90 | 2046 | 56317 x 2 + 56010 x 6 | 55458 | 789,60 | 56317 x 3 + 56010 x 8 | 55495 | 918,70 | 56317 x 3 + 56010 x 10 | |
| 55422 | 681,40 | 2154 | 56317 x 3 + 56007 x 3 + 56014 | 55459 | 817,20 | 56317 x 3 + 56007 x 4 + 56014 | 55496 | 953,00 | 56317 x 3 + 56007 x 5 + 56014 | |
| 55423 | 689,10 | 2264 | 56317 x 3 + 56007 x 3 + 56015 | 55460 | 826,80 | 56317 x 3 + 56007 x 4 + 56015 | 55497 | 965,80 | 56317 x 3 + 56007 x 5 + 56015 | |
| 55424 | 696,80 | 2376 | 56317 x 3 + 56010 x 3 + 56013 | 55461 | 837,90 | 56317 x 3 + 56010 x 4 + 56013 | 55498 | 979,10 | 56317 x 3 + 56010 x 5 + 56013 | |
| 55425 | 727,90 | 2481 | 56317 x 3 + 56010 x 3 + 56014 | 55462 | 879,30 | 56317 x 3 + 56010 x 4 + 56014 | 55499 | 1030,70 | 56317 x 3 + 56010 x 5 + 56014 | |
| 55426 | 735,50 | 2591 | 56317 x 3 + 56010 x 3 + 56015 | 55463 | 888,80 | 56317 x 3 + 56010 x 4 + 56015 | 55500 | 1043,50 | 56317 x 3 + 56010 x 5 + 56015 | |
| 55427 | 751,00 | 2701 | 56317 x 3 + 56011 x 3 + 56015 | 55464 | 910,20 | 56317 x 3 + 56011 x 4 + 56015 | 55501 | 1069,30 | 56317 x 3 + 56011 x 5 + 56015 | |
| 55428 | 764,10 | 2811 | 56317 x 3 + 56013 x 3 + 56014 | 55465 | 927,70 | 56317 x 3 + 56013 x 4 + 56014 | 55502 | 1091,10 | 56317 x 3 + 56013 x 5 + 56014 | |
| 55429 | 794,40 | 2916 | 56317 x 2 + 56014 x 6 | 55466 | 968,80 | 56317 x 3 + 56014 x 8 | 55503 | 1142,40 | 56317 x 3 + 56014 x 10 | |
| 55430 | 801,50 | 3026 | 56317 x 3 + 56014 x 3 + 56015 | 55467 | 978,80 | 56317 x 3 + 56014 x 4 + 56015 x | 55504 | 1155,20 | 56317 x 3 + 56014 x 5 + 56015 x | |
| 55431 | 810,10 | 3136 | 56317 x 3 + 56015 x 6 | 55468 | 989,30 | 56317 x 3 + 56015 x 8 | 55505 | 1168,00 | 56317 x 3 + 56015 x 10 | |

| TRIPLE | Ref | € | L (mm) | Desglose | Ref | € | Desglose | Ref | € | Desglose |
|--------|---------|--------|-------------------------------|-------------------------------|---------|-------------------------------|-------------------------------|---------|--------------------------------|--------------------------------|
| | 55432 | 973,80 | 3275 | 56317 x 4 + 56010 x 6 + 56012 | 55469 | 1177,20 | 56317 x 4 + 56010 x 8 + 56012 | 55506 | 1380,20 | 56317 x 4 + 56010 x 10 + 56012 |
| 55433 | 981,50 | 3385 | 56317 x 4 + 56010 x 6 + 56013 | 55470 | 1187,40 | 56317 x 4 + 56010 x 8 + 56013 | 55507 | 1393,00 | 56317 x 4 + 56010 x 10 + 56013 | |
| 55434 | 1012,40 | 3490 | 56317 x 4 + 56010 x 6 + 56014 | 55471 | 1228,50 | 56317 x 4 + 56010 x 8 + 56014 | 55508 | 1444,30 | 56317 x 4 + 56010 x 10 + 56014 | |
| 55435 | 1033,10 | 3598 | 56317 x 4 + 56007 x 3 + 56014 | 55472 | 1255,90 | 56317 x 4 + 56007 x 4 + 56014 | 55509 | 1479,00 | 56317 x 4 + 56007 x 5 + 56014 | |
| 55436 | 1043,80 | 3710 | 56317 x 4 + 56011 x 6 + 56014 | 55473 | 1270,00 | 56317 x 4 + 56011 x 8 + 56014 | 55510 | 1496,40 | 56317 x 4 + 56011 x 10 + 56014 | |
| 55437 | 1048,30 | 3818 | 56317 x 4 + 56007 x 3 + 56015 | 55474 | 1276,20 | 56317 x 4 + 56007 x 4 + 56015 | 55511 | 1504,10 | 56317 x 4 + 56007 x 5 + 56015 | |
| 55438 | 1079,60 | 3925 | 56317 x 4 + 56010 x 3 + 56014 | 55475 | 1318,30 | 56317 x 4 + 56010 x 4 + 56014 | 55512 | 1556,40 | 56317 x 4 + 56010 x 5 + 56014 | |
| 55439 | 1095,30 | 4035 | 56317 x 4 + 56011 x 3 + 56014 | 55476 | 1345,40 | 56317 x 4 + 56011 x 4 + 56014 | 55513 | 1582,40 | 56317 x 4 + 56011 x 5 + 56014 | |
| 55440 | 1099,10 | 4145 | 56317 x 4 + 56010 x 3 + 56015 | 55477 | 1352,20 | 56317 x 4 + 56010 x 4 + 56015 | 55514 | 1591,70 | 56317 x 4 + 56010 x 5 + 56015 | |
| 55441 | 1110,40 | 4255 | 56317 x 4 + 56011 x 3 + 56015 | 55478 | 1359,20 | 56317 x 4 + 56011 x 4 + 56015 | 55515 | 1607,80 | 56317 x 4 + 56011 x 5 + 56015 | |
| 55442 | 1146,90 | 4360 | 56317 x 4 + 56014 x 9 | 55479 | 1407,50 | 56317 x 4 + 56014 x 12 | 55516 | 1668,40 | 56317 x 4 + 56014 x 15 | |
| 55443 | 1154,50 | 4470 | 56317 x 4 + 56014 x 6 + 56015 | 55480 | 1417,70 | 56317 x 4 + 56014 x 8 + 56015 | 55517 | 1681,10 | 56317 x 4 + 56014 x 10 + 56015 | |
| 55444 | 1161,90 | 4580 | 56317 x 4 + 56014 x 3 + 56015 | 55481 | 1427,90 | 56317 x 4 + 56014 x 4 + 56015 | 55518 | 1693,90 | 56317 x 4 + 56014 x 5 + 56015 | |
| 55445 | 1169,70 | 4690 | 56317 x 4 + 56015 x 9 | 55482 | 1437,90 | 56317 x 4 + 56015 x 12 | 55519 | 1706,60 | 56317 x 4 + 56015 x 15 | |

385x2000 mm

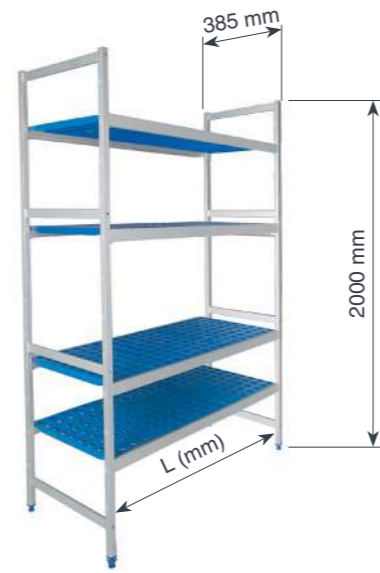

Estantería completa

Rayonnage complet · Regale, komplett
Full shelving · Estantes completa

3 Estantes · Shelf

| Ref | € | L (mm) | Desglose |
|-------|--------|--------|-----------------------|
| 55520 | 360,00 | 710 | 56320 x 2 + 56007 x 3 |
| 55521 | 367,70 | 822 | 56320 x 2 + 56008 x 3 |
| 55522 | 381,70 | 932 | 56320 x 2 + 56009 x 3 |
| 55523 | 405,60 | 1037 | 56320 x 2 + 56010 x 3 |
| 55524 | 421,80 | 1147 | 56320 x 2 + 56011 x 3 |
| 55525 | 435,10 | 1257 | 56320 x 2 + 56012 x 3 |
| 55526 | 442,60 | 1367 | 56320 x 2 + 56013 x 3 |
| 55527 | 473,40 | 1472 | 56320 x 2 + 56014 x 3 |
| 55528 | 481,00 | 1582 | 56320 x 2 + 56015 x 3 |

4 Estantes · Shelf

| Ref | € | Desglose |
|-------|--------|-----------------------|
| 55557 | 408,80 | 56320 x 2 + 56007 x 4 |
| 55558 | 419,50 | 56320 x 2 + 56008 x 4 |
| 55559 | 439,90 | 56320 x 2 + 56009 x 4 |
| 55560 | 470,70 | 56320 x 2 + 56010 x 4 |
| 55561 | 491,70 | 56320 x 2 + 56011 x 4 |
| 55562 | 508,90 | 56320 x 2 + 56012 x 4 |
| 55563 | 519,30 | 56320 x 2 + 56013 x 4 |
| 55564 | 560,40 | 56320 x 2 + 56014 x 4 |
| 55565 | 570,40 | 56320 x 2 + 56015 x 4 |

5 Estantes · Shelf

| Ref | € | Desglose |
|-------|--------|-----------------------|
| 55594 | 457,80 | 56320 x 2 + 56007 x 5 |
| 55595 | 471,10 | 56320 x 2 + 56008 x 5 |
| 55596 | 496,60 | 56320 x 2 + 56009 x 5 |
| 55597 | 535,10 | 56320 x 2 + 56010 x 5 |
| 55598 | 561,40 | 56320 x 2 + 56011 x 5 |
| 55599 | 583,10 | 56320 x 2 + 56012 x 5 |
| 55600 | 595,90 | 56320 x 2 + 56013 x 5 |
| 55601 | 647,20 | 56320 x 2 + 56014 x 5 |
| 55602 | 659,90 | 56320 x 2 + 56015 x 5 |

SIMPLE

DOBLE · DOUBLE

TRIPLE

| Ref | € | L (mm) | Desglose |
|-------|--------|--------|-------------------------------|
| 55529 | 659,40 | 1719 | 56320 x 3 + 56007 x 3 + 56010 |
| 55530 | 675,50 | 1829 | 56320 x 3 + 56007 x 3 + 56011 |
| 55531 | 688,60 | 1939 | 56320 x 3 + 56007 x 3 + 56012 |
| 55532 | 706,10 | 2046 | 56320 x 3 + 56010 x 6 |
| 55533 | 726,90 | 2154 | 56320 x 3 + 56007 x 3 + 56014 |
| 55534 | 734,40 | 2264 | 56320 x 3 + 56007 x 3 + 56015 |
| 55535 | 742,50 | 2376 | 56320 x 3 + 56010 x 3 + 56013 |
| 55536 | 773,40 | 2481 | 56320 x 3 + 56010 x 3 + 56014 |
| 55537 | 780,90 | 2591 | 56320 x 3 + 56010 x 3 + 56015 |
| 55538 | 796,70 | 2701 | 56320 x 3 + 56011 x 3 + 56015 |
| 55539 | 808,60 | 2811 | 56320 x 3 + 56013 x 3 + 56014 |
| 55540 | 839,60 | 2916 | 56320 x 2 + 56014 x 6 |
| 55541 | 848,30 | 3026 | 56320 x 3 + 56014 x 3 + 56015 |
| 55542 | 855,80 | 3136 | 56320 x 3 + 56015 x 6 |

| Ref | € | Desglose |
|-------|---------|---------------------------------|
| 55566 | 773,30 | 56320 x 3 + 56007 x 4 + 56010 |
| 55567 | 793,20 | 56320 x 3 + 56007 x 4 + 56011 |
| 55568 | 811,60 | 56320 x 3 + 56007 x 4 + 56012 |
| 55569 | 835,30 | 56320 x 3 + 56010 x 8 |
| 55570 | 862,80 | 56320 x 3 + 56007 x 4 + 56014 |
| 55571 | 872,10 | 56320 x 3 + 56007 x 4 + 56015 |
| 55572 | 883,30 | 56320 x 3 + 56010 x 4 + 56013 |
| 55573 | 924,90 | 56320 x 3 + 56010 x 4 + 56014 |
| 55574 | 934,90 | 56320 x 3 + 56010 x 4 + 56015 |
| 55575 | 955,90 | 56320 x 3 + 56011 x 4 + 56015 |
| 55576 | 973,20 | 56320 x 3 + 56013 x 4 + 56014 |
| 55577 | 1014,30 | 56320 x 3 + 56014 x 8 |
| 55578 | 1024,70 | 56320 x 3 + 56014 x 4 + 56015 x |
| 55579 | 1034,60 | 56320 x 3 + 56015 x 8 |

| Ref | € | Desglose |
|-------|---------|---------------------------------|
| 55603 | 886,80 | 56320 x 3 + 56007 x 5 + 56010 |
| 55604 | 912,80 | 56320 x 3 + 56007 x 5 + 56011 |
| 55605 | 934,70 | 56320 x 3 + 56007 x 5 + 56012 |
| 55606 | 964,30 | 56320 x 3 + 56010 x 10 |
| 55607 | 998,80 | 56320 x 3 + 56007 x 5 + 56014 |
| 55608 | 1011,40 | 56320 x 3 + 56007 x 5 + 56015 |
| 55609 | 1024,80 | 56320 x 3 + 56010 x 5 + 56013 |
| 55610 | 1076,30 | 56320 x 3 + 56010 x 5 + 56014 |
| 55611 | 1089,00 | 56320 x 3 + 56010 x 5 + 56015 |
| 55612 | 1115,00 | 56320 x 3 + 56011 x 5 + 56015 |
| 55613 | 1136,80 | 56320 x 3 + 56013 x 5 + 56014 |
| 55614 | 1188,30 | 56320 x 3 + 56014 x 10 |
| 55615 | 1201,00 | 56320 x 3 + 56014 x 5 + 56015 x |
| 55616 | 1213,50 | 56320 x 3 + 56015 x 10 |

| Ref | € | L (mm) | Desglose |
|-------|---------|--------|-------------------------------|
| 55543 | 1034,70 | 3275 | 56320 x 4 + 56010 x 6 + 56012 |
| 55544 | 1042,40 | 3385 | 56320 x 4 + 56010 x 6 + 56013 |
| 55545 | 1073,30 | 3490 | 56320 x 4 + 56010 x 6 + 56014 |
| 55546 | 1094,10 | 3598 | 56320 x 4 + 56007 x 3 + 56014 |
| 55547 | 1104,60 | 3710 | 56320 x 4 + 56011 x 6 + 56014 |
| 55548 | 1109,10 | 3818 | 56320 x 4 + 56007 x 3 + 56015 |
| 55549 | 1140,60 | 3925 | 56320 x 4 + 56010 x 3 + 56014 |
| 55550 | 1155,90 | 4035 | 56320 x 4 + 56011 x 3 + 56014 |
| 55551 | 1155,50 | 4145 | 56320 x 4 + 56010 x 3 + 56015 |
| 55552 | 1171,30 | 4255 | 56320 x 4 + 56011 x 3 + 56015 |
| 55553 | 1207,70 | 4360 | 56320 x 4 + 56014 x 9 |
| 55554 | 1215,40 | 4470 | 56320 x 4 + 56014 x 6 + 56015 |
| 55555 | 1222,90 | 4580 | 56320 x 4 + 56014 x 3 + 56015 |
| 55556 | 1230,50 | 4690 | 56320 x 4 + 56015 x 9 |

| Ref | € | Desglose |
|-------|---------|-------------------------------|
| 55580 | 1238,00 | 56320 x 4 + 56010 x 8 + 56012 |
| 55581 | 1248,20 | 56320 x 4 + 56010 x 8 + 56013 |
| 55582 | 1289,30 | 56320 x 4 + 56010 x 8 + 56014 |
| 55583 | 1316,70 | 56320 x 4 + 56007 x 4 + 56014 |
| 55584 | 1331,00 | 56320 x 4 + 56011 x 8 + 56014 |
| 55585 | 1337,20 | 56320 x 4 + 56007 x 4 + 56015 |
| 55586 | 1379,00 | 56320 x 4 + 56010 x 4 + 56014 |
| 55587 | 1399,70 | 56320 x 4 + 56011 x 4 + 56014 |
| 55588 | 1399,30 | 56320 x 4 + 56010 x 4 + 56015 |
| 55589 | 1420,00 | 56320 x 4 + 56011 x 4 + 56015 |
| 55590 | 1467,90 | 56320 x 4 + 56014 x 12 |
| 55591 | 1477,70 | 56320 x 4 + 56014 x 8 + 56015 |
| 55592 | 1488,80 | 56320 x 4 + 56014 x 4 + 56015 |
| 55593 | 1499,00 | 56320 x 4 + 56015 x 12 |

| Ref | € | Desglose |
|-------|---------|--------------------------------|
| 55617 | 1441,10 | 56320 x 4 + 56010 x 10 + 56012 |
| 55618 | 1453,90 | 56320 x 4 + 56010 x 10 + 56013 |
| 55619 | 1505,30 | 56320 x 4 + 56010 x 10 + 56014 |
| 55620 | 1539,70 | 56320 x 4 + 56007 x 5 + 56014 |
| 55621 | 1557,40 | 56320 x 4 + 56011 x 10 + 56014 |
| 55622 | 1565,00 | 56320 x 4 + 56007 x 5 + 56015 |
| 55623 | 1617,10 | 56320 x 4 + 56010 x 5 + 56014 |
| 55624 | 1643,20 | 56320 x 4 + 56011 x 5 + 56014 |
| 55625 | 1642,60 | 56320 x 4 + 56010 x 5 + 56015 |
| 55626 | 1668,60 | 56320 x 4 + 56011 x 5 + 56015 |
| 55627 | 1729,20 | 56320 x 4 + 56014 x 15 |
| 55628 | 1741,90 | 56320 x 4 + 56014 x 10 + 56015 |
| 55629 | 1754,70 | 56320 x 4 + 56014 x 5 + 56015 |
| 55630 | 1767,20 | 56320 x 4 + 56015 x 15 |

560x1750 mm

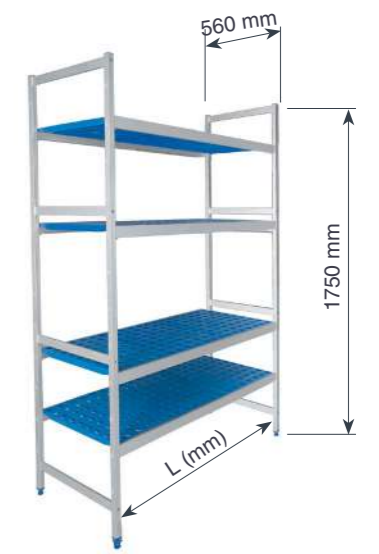

Estantería completa

Rayonnage complet · Regale, komplet
Full shelving · Estantes completa

3 Estantes · Shelf

| Ref | € | L (mm) | Desglose |
|-------|--------|--------|-----------------------|
| 55709 | 367,70 | 710 | 57317 x 2 + 57007 x 3 |
| 55710 | 375,50 | 822 | 57317 x 2 + 57008 x 3 |
| 55711 | 390,20 | 932 | 57317 x 2 + 57009 x 3 |
| 55712 | 426,90 | 1037 | 57317 x 2 + 57010 x 3 |
| 55713 | 443,00 | 1147 | 57317 x 2 + 57011 x 3 |
| 55714 | 458,20 | 1257 | 57317 x 2 + 57012 x 3 |
| 55715 | 473,40 | 1367 | 57317 x 2 + 57013 x 3 |
| 55716 | 504,30 | 1472 | 57317 x 2 + 57014 x 3 |
| 55717 | 519,50 | 1582 | 57317 x 2 + 57015 x 3 |

4 Estantes · Shelf

| Ref | € | Desglose |
|-------|--------|-----------------------|
| 55746 | 424,00 | 57317 x 2 + 57007 x 4 |
| 55747 | 433,70 | 57317 x 2 + 57008 x 4 |
| 55748 | 455,10 | 57317 x 2 + 57009 x 4 |
| 55749 | 504,10 | 57317 x 2 + 57010 x 4 |
| 55750 | 525,00 | 57317 x 2 + 57011 x 4 |
| 55751 | 545,20 | 57317 x 2 + 57012 x 4 |
| 55752 | 565,50 | 57317 x 2 + 57013 x 4 |
| 55753 | 606,40 | 57317 x 2 + 57014 x 4 |
| 55754 | 626,80 | 57317 x 2 + 57015 x 4 |

5 Estantes · Shelf

| Ref | € | Desglose |
|-------|--------|-----------------------|
| 55783 | 481,40 | 57317 x 2 + 57007 x 5 |
| 55784 | 494,00 | 57317 x 2 + 57008 x 5 |
| 55785 | 520,10 | 57317 x 2 + 57009 x 5 |
| 55786 | 580,60 | 57317 x 2 + 57010 x 5 |
| 55787 | 606,60 | 57317 x 2 + 57011 x 5 |
| 55788 | 632,00 | 57317 x 2 + 57012 x 5 |
| 55789 | 657,40 | 57317 x 2 + 57013 x 5 |
| 55790 | 709,00 | 57317 x 2 + 57014 x 5 |
| 55791 | 733,90 | 57317 x 2 + 57015 x 5 |

SIMPLE

DOBLE · DOUBLE

TRIPLE

| Ref | € | L (mm) | Desglose |
|-------|--------|--------|-------------------------------|
| 55718 | 696,40 | 1719 | 57317 x 3 + 57007 x 3 + 57010 |
| 55719 | 712,00 | 1829 | 57317 x 3 + 57007 x 3 + 57011 |
| 55720 | 726,90 | 1939 | 57317 x 3 + 57007 x 3 + 57012 |
| 55721 | 755,10 | 2046 | 57317 x 3 + 57010 x 6 |
| 55722 | 773,40 | 2154 | 57317 x 3 + 57007 x 3 + 57014 |
| 55723 | 787,30 | 2264 | 57317 x 3 + 57007 x 3 + 57015 |
| 55724 | 802,10 | 2376 | 57317 x 3 + 57010 x 3 + 57013 |
| 55725 | 832,50 | 2481 | 57317 x 3 + 57010 x 3 + 57014 |
| 55726 | 848,30 | 2591 | 57317 x 3 + 57010 x 3 + 57015 |
| 55727 | 863,50 | 2701 | 57317 x 3 + 57011 x 3 + 57015 |
| 55728 | 879,10 | 2811 | 57317 x 3 + 57013 x 3 + 57014 |
| 55729 | 909,80 | 2916 | 57317 x 3 + 57014 x 6 |
| 55730 | 925,10 | 3026 | 57317 x 3 + 57014 x 3 + 57015 |
| 55731 | 940,30 | 3136 | 57317 x 3 + 57015 x 6 |

| Ref | € | Desglose |
|-------|---------|---------------------------------|
| 55755 | 829,90 | 57317 x 3 + 57007 x 4 + 57010 |
| 55756 | 850,50 | 57317 x 3 + 57007 x 4 + 57011 |
| 55757 | 870,50 | 57317 x 3 + 57007 x 4 + 57012 |
| 55758 | 909,40 | 57317 x 3 + 57010 x 8 |
| 55759 | 932,50 | 57317 x 3 + 57007 x 4 + 57014 |
| 55760 | 952,70 | 57317 x 3 + 57007 x 4 + 57015 |
| 55761 | 970,90 | 57317 x 3 + 57010 x 4 + 57013 |
| 55762 | 1011,90 | 57317 x 3 + 57010 x 4 + 57014 |
| 55763 | 1032,20 | 57317 x 3 + 57010 x 4 + 57015 |
| 55764 | 1052,90 | 57317 x 3 + 57011 x 4 + 57015 |
| 55765 | 1073,30 | 57317 x 3 + 57013 x 4 + 57014 |
| 55766 | 1114,30 | 57317 x 3 + 57014 x 8 |
| 55767 | 1134,80 | 57317 x 3 + 57014 x 4 + 57015 x |
| 55768 | 1154,90 | 57317 x 3 + 57015 x 8 |

| Ref | € | Desglose |
|-------|---------|-------------------------------|
| 55792 | 963,40 | 57317 x 3 + 57007 x 5 + 57010 |
| 55793 | 989,50 | 57317 x 3 + 57007 x 5 + 57011 |
| 55794 | 1014,50 | 57317 x 3 + 57007 x 5 + 57012 |
| 55795 | 1062,50 | 57317 x 3 + 57010 x 10 |
| 55796 | 1091,30 | 57317 x 3 + 57007 x 5 + 57014 |
| 55797 | 1116,80 | 57317 x 3 + 57007 x 5 + 57015 |
| 55798 | 1139,50 | 57317 x 3 + 57010 x 5 + 57013 |
| 55799 | 1190,90 | 57317 x 3 + 57010 x 5 + 57014 |
| 55800 | 1216,00 | 57317 x 3 + 57010 x 5 + 57015 |
| 55801 | 1242,30 | 57317 x 3 + 57011 x 5 + 57015 |
| 55802 | 1267,50 | 57317 x |

560x2000 mm



Estantería completa

Rayonnage complet · Regale, komplett
Full shelving · Estantes completa

3 Estantes · Shelf

4 Estantes · Shelf

5 Estantes · Shelf

SIMPLE

| Ref | € | L (mm) | Desglose |
|-------|--------|--------|-----------------------|
| 55820 | 398,40 | 710 | 57320 x 2 + 57007 x 3 |
| 55821 | 405,60 | 822 | 57320 x 2 + 57008 x 3 |
| 55822 | 421,50 | 932 | 57320 x 2 + 57009 x 3 |
| 55823 | 457,80 | 1037 | 57320 x 2 + 57010 x 3 |
| 55824 | 473,40 | 1147 | 57320 x 2 + 57011 x 3 |
| 55825 | 488,70 | 1257 | 57320 x 2 + 57012 x 3 |
| 55826 | 503,90 | 1367 | 57320 x 2 + 57013 x 3 |
| 55827 | 534,70 | 1472 | 57320 x 2 + 57014 x 3 |
| 55828 | 550,00 | 1582 | 57320 x 2 + 57015 x 3 |

| Ref | € | Desglose |
|-------|--------|-----------------------|
| 55857 | 455,10 | 57320 x 2 + 57007 x 4 |
| 55858 | 465,20 | 57320 x 2 + 57008 x 4 |
| 55859 | 485,80 | 57320 x 2 + 57009 x 4 |
| 55860 | 534,40 | 57320 x 2 + 57010 x 4 |
| 55861 | 555,30 | 57320 x 2 + 57011 x 4 |
| 55862 | 575,80 | 57320 x 2 + 57012 x 4 |
| 55863 | 595,90 | 57320 x 2 + 57013 x 4 |
| 55864 | 637,00 | 57320 x 2 + 57014 x 4 |
| 55865 | 657,30 | 57320 x 2 + 57015 x 4 |

| Ref | € | Desglose |
|-------|--------|-----------------------|
| 55894 | 511,70 | 57320 x 2 + 57007 x 5 |
| 55895 | 524,50 | 57320 x 2 + 57008 x 5 |
| 55896 | 550,40 | 57320 x 2 + 57009 x 5 |
| 55897 | 611,00 | 57320 x 2 + 57010 x 5 |
| 55898 | 637,10 | 57320 x 2 + 57011 x 5 |
| 55899 | 662,50 | 57320 x 2 + 57012 x 5 |
| 55900 | 688,00 | 57320 x 2 + 57013 x 5 |
| 55901 | 738,10 | 57320 x 2 + 57014 x 5 |
| 55902 | 763,40 | 57320 x 2 + 57015 x 5 |

| Ref | € | L (mm) | Desglose |
|-------|--------|--------|-------------------------------|
| 55829 | 741,10 | 1719 | 57320 x 3 + 57007 x 3 + 57010 |
| 55830 | 757,80 | 1829 | 57320 x 3 + 57007 x 3 + 57011 |
| 55831 | 771,90 | 1939 | 57320 x 3 + 57007 x 3 + 57012 |
| 55832 | 801,60 | 2046 | 57320 x 3 + 57010 x 6 |
| 55833 | 819,10 | 2154 | 57320 x 3 + 57007 x 3 + 57014 |
| 55834 | 833,90 | 2264 | 57320 x 3 + 57007 x 3 + 57015 |
| 55835 | 846,50 | 2376 | 57320 x 3 + 57010 x 3 + 57013 |
| 55836 | 877,50 | 2481 | 57320 x 3 + 57010 x 3 + 57014 |
| 55837 | 893,90 | 2591 | 57320 x 3 + 57010 x 3 + 57015 |
| 55838 | 909,50 | 2701 | 57320 x 3 + 57011 x 3 + 57015 |
| 55839 | 924,70 | 2811 | 57320 x 3 + 57013 x 3 + 57014 |
| 55840 | 955,50 | 2916 | 57320 x 3 + 57014 x 6 |
| 55841 | 970,90 | 3026 | 57320 x 3 + 57014 x 3 + 57015 |
| 55842 | 985,90 | 3136 | 57320 x 3 + 57015 x 6 |

| Ref | € | Desglose |
|-------|---------|---------------------------------|
| 55866 | 875,50 | 57320 x 3 + 57007 x 4 + 57010 |
| 55867 | 895,90 | 57320 x 3 + 57007 x 4 + 57011 |
| 55868 | 915,60 | 57320 x 3 + 57007 x 4 + 57012 |
| 55869 | 954,90 | 57320 x 3 + 57010 x 8 |
| 55870 | 978,00 | 57320 x 3 + 57007 x 4 + 57014 |
| 55871 | 998,50 | 57320 x 3 + 57007 x 4 + 57015 |
| 55872 | 1016,40 | 57320 x 3 + 57010 x 4 + 57013 |
| 55873 | 1057,60 | 57320 x 3 + 57010 x 4 + 57014 |
| 55874 | 1077,90 | 57320 x 3 + 57010 x 4 + 57015 |
| 55875 | 1098,60 | 57320 x 3 + 57011 x 4 + 57015 |
| 55876 | 1119,10 | 57320 x 3 + 57013 x 4 + 57014 |
| 55877 | 1160,00 | 57320 x 3 + 57014 x 8 |
| 55878 | 1180,40 | 57320 x 3 + 57014 x 4 + 57015 x |
| 55879 | 1200,80 | 57320 x 3 + 57015 x 8 |

| Ref | € | Desglose |
|-------|---------|---------------------------------|
| 55903 | 1009,20 | 57320 x 3 + 57007 x 5 + 57010 |
| 55904 | 1034,80 | 57320 x 3 + 57007 x 5 + 57011 |
| 55905 | 1060,30 | 57320 x 3 + 57007 x 5 + 57012 |
| 55906 | 1108,30 | 57320 x 3 + 57010 x 10 |
| 55907 | 1137,00 | 57320 x 3 + 57007 x 5 + 57014 |
| 55908 | 1162,50 | 57320 x 3 + 57007 x 5 + 57015 |
| 55909 | 1184,90 | 57320 x 3 + 57010 x 5 + 57013 |
| 55910 | 1236,40 | 57320 x 3 + 57010 x 5 + 57014 |
| 55911 | 1262,00 | 57320 x 3 + 57010 x 5 + 57015 |
| 55912 | 1287,70 | 57320 x 3 + 57011 x 5 + 57015 |
| 55913 | 1313,30 | 57320 x 3 + 57013 x 5 + 57014 |
| 55914 | 1364,90 | 57320 x 3 + 57014 x 10 |
| 55915 | 1390,00 | 57320 x 3 + 57014 x 5 + 57015 x |
| 55916 | 1415,20 | 57320 x 3 + 57015 x 10 |

| Ref | € | L (mm) | Desglose |
|-------|---------|--------|-------------------------------|
| 55843 | 1176,50 | 3275 | 57320 x 4 + 57010 x 6 + 57012 |
| 55844 | 1191,60 | 3385 | 57320 x 4 + 57010 x 6 + 57013 |
| 55845 | 1222,50 | 3490 | 57320 x 4 + 57010 x 6 + 57014 |
| 55846 | 1239,80 | 3598 | 57320 x 4 + 57007 x 3 + 57014 |
| 55847 | 1253,80 | 3710 | 57320 x 4 + 57011 x 6 + 57014 |
| 55848 | 1270,40 | 3818 | 57320 x 4 + 57007 x 3 + 57015 |
| 55849 | 1299,60 | 3925 | 57320 x 4 + 57010 x 3 + 57014 |
| 55850 | 1315,00 | 4035 | 57320 x 4 + 57011 x 3 + 57014 |
| 55851 | 1329,70 | 4145 | 57320 x 4 + 57010 x 3 + 57015 |
| 55852 | 1345,70 | 4255 | 57320 x 4 + 57011 x 3 + 57015 |
| 55853 | 1376,30 | 4360 | 57320 x 4 + 57014 x 9 |
| 55854 | 1391,50 | 4470 | 57320 x 4 + 57014 x 6 + 57015 |
| 55855 | 1406,80 | 4580 | 57320 x 4 + 57014 x 3 + 57015 |
| 55856 | 1422,10 | 4690 | 57320 x 4 + 57015 x 9 |

| Ref | € | Desglose |
|-------|---------|-------------------------------|
| 55880 | 1416,70 | 57320 x 4 + 57010 x 8 + 57012 |
| 55881 | 1436,90 | 57320 x 4 + 57010 x 8 + 57013 |
| 55882 | 1478,00 | 57320 x 4 + 57010 x 8 + 57014 |
| 55883 | 1500,30 | 57320 x 4 + 57007 x 4 + 57014 |
| 55884 | 1519,80 | 57320 x 4 + 57011 x 8 + 57014 |
| 55885 | 1541,00 | 57320 x 4 + 57007 x 4 + 57015 |
| 55886 | 1580,50 | 57320 x 4 + 57010 x 4 + 57014 |
| 55887 | 1601,60 | 57320 x 4 + 57011 x 4 + 57014 |
| 55888 | 1621,20 | 57320 x 4 + 57010 x 4 + 57015 |
| 55889 | 1641,20 | 57320 x 4 + 57011 x 4 + 57015 |
| 55890 | 1683,00 | 57320 x 4 + 57014 x 12 |
| 55891 | 1703,40 | 57320 x 4 + 57014 x 8 + 57015 |
| 55892 | 1722,70 | 57320 x 4 + 57014 x 4 + 57015 |
| 55893 | 1744,00 | 57320 x 4 + 57015 x 12 |

| Ref | € | Desglose |
|-------|---------|--------------------------------|
| 55917 | 1656,70 | 57320 x 4 + 57010 x 10 + 57012 |
| 55918 | 1682,00 | 57320 x 4 + 57010 x 10 + 57013 |
| 55919 | 1732,70 | 57320 x 4 + 57010 x 10 + 57014 |
| 55920 | 1762,20 | 57320 x 4 + 57007 x 5 + 57014 |
| 55921 | 1784,90 | 57320 x 4 + 57011 x 10 + 57014 |
| 55922 | 1812,80 | 57320 x 4 + 57007 x 5 + 57015 |
| 55923 | 1861,60 | 57320 x 4 + 57010 x 5 + 57014 |
| 55924 | 1887,80 | 57320 x 4 + 57011 x 5 + 57014 |
| 55925 | 1912,50 | 57320 x 4 + 57010 x 5 + 57015 |
| 55926 | 1938,40 | 57320 x 4 + 57011 x 5 + 57015 |
| 55927 | 1990,10 | 57320 x 4 + 57014 x 15 |
| 55928 | 2015,50 | 57320 x 4 + 57014 x 10 + 57015 |
| 55929 | 2040,60 | 57320 x 4 + 57014 x 5 + 57015 |
| 55930 | 2066,00 | 57320 x 4 + 57015 x 15 |

385x1750 mm

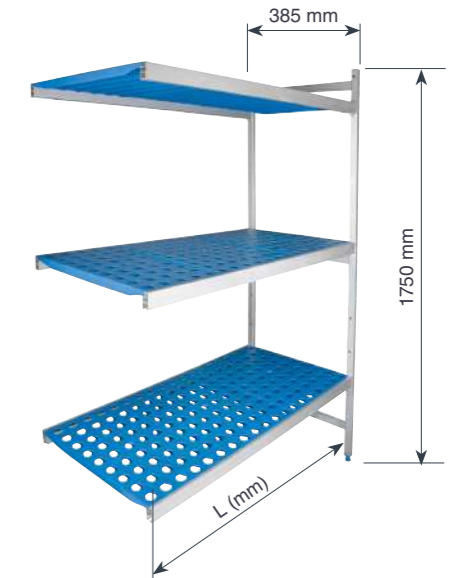

Estantería abierta

Rayonnage ouvertes · Offenes Regale
Open shelving · Estantes abiertas

3 Estantes · Shelf

4 Estantes · Shelf

5 Estantes · Shelf

SIMPLE

| Ref | € | L (mm) | Desglose |
|-------|--------|--------|-----------------------|
| 55631 | 238,30 | 682 | 56317 x 1 + 56007 x 3 |
| 55632 | 246,00 | 794 | 56317 x 1 + 56008 x 3 |
| 55633 | 261,60 | 904 | 56317 x 1 + 56009 x 3 |
| 55634 | 284,70 | 1009 | 56317 x 1 + 56010 x 3 |
| 55635 | 300,50 | 1119 | 56317 x 1 + 56011 x 3 |
| 55636 | 313,60 | 1229 | 56317 x 1 + 56012 x 3 |
| 55637 | 321,00 | 1339 | 56317 x 1 + 56013 x 3 |
| 55638 | 352,00 | 1444 | 56317 x 1 + 56014 x 3 |
| 55639 | 359,70 | 1554 | 56317 x 1 + 56015 x 3 |

| Ref | € | L (mm) |
|-------|--------|-----------------------|
| 55640 | 287,30 | 56317 x 1 + 56007 x 4 |
| 55641 | 297,90 | 56317 x 1 + 56008 x 4 |
| 55642 | 318,10 | 56317 x 1 + 56009 x 4 |
| 55643 | 349,10 | 56317 x 1 + 56010 x 4 |
| 55644 | 369,90 | 56317 x 1 + 56011 x 4 |
| 55645 | 387,40 | 56317 x 1 + 56012 x 4 |
| 55646 | 397,60 | 56317 x 1 + 56013 x 4 |
| 55647 | 438,80 | 56317 x 1 + 56014 x 4 |
| 55648 | 449,10 | 56317 x 1 + 56015 x 4 |

| Ref | € | Desglose |
|-------|--------|-----------------------|
| 55649 | 336,20 | 56317 x 1 + 56007 x 5 |
| 55650 | 349,60 | 56317 x 1 + 56008 x 5 |
| 55651 | 375,10 | 56317 x 1 + 56009 x 5 |
| 55652 | 413,70 | 56317 x 1 + 56010 x 5 |
| 55653 | 439,90 | 56317 x 1 + 56011 x 5 |
| 55654 | 461,70 | 56317 x 1 + 56012 x 5 |
| 55655 | 474,40 | 56317 x 1 + 56013 x 5 |
| 55656 | 525,80 | 56317 x 1 + 56014 x 5 |
| 55657 | 538,60 | 56317 x 1 + 56015 x 5 |

385x2000 mm



Estantería abierta

Rayonnage ouvertes · Offenes Regale
Open shelving · Estantes abiertas

3 Estantes · Shelf

4 Estantes · Shelf

5 Estantes · Shelf

SIMPLE

| Ref | € | L (mm) | Desglose |
|-------|--------|--------|-----------------------|
| 55658 | 253,40 | 682 | 56320 x 1 + 56007 x 3 |
| 55659 | 261,60 | 794 | 56320 x 1 + 56008 x 3 |
| 55660 | 276,60 | 904 | 56320 x 1 + 56009 x 3 |
| 55661 | 300,10 | 1009 | 56320 x 1 + 56010 x 3 |
| 55662 | 315,50 | 1119 | 56320 x 1 + 56011 x 3 |
| 55663 | 328,70 | 1229 | 56320 x 1 + 56012 x 3 |
| 55664 | 336,20 | 1339 | 56320 x 1 + 56013 x 3 |
| 55665 | 366,50 | 1444 | 56320 x 1 + 56014 x 3 |
| 55666 | 374,80 | 1554 | 56320 x 1 + 56015 x 3 |

| Ref | € | L (mm) |
|-------|--------|-----------------------|
| 55667 | 302,30 | 56320 x 1 + 56007 x 4 |
| 55668 | 313,40 | 56320 x 1 + 56008 x 4 |
| 55669 | 333,50 | 56320 x 1 + 56009 x 4 |
| 55670 | 364,40 | 56320 x 1 + 56010 x 4 |
| 55671 | 385,10 | 56320 x 1 + 56011 x 4 |
| 55672 | 401,60 | 56320 x 1 + 56012 x 4 |
| 55673 | 412,90 | 56320 x 1 + 56013 x 4 |
| 55674 | 454,00 | 56320 x 1 + 56014 x 4 |
| 55675 | 464,20 | 56320 x 1 + 56015 x 4 |

| Ref | € | Desglose |
|-------|--------|-----------------------|
| 55676 | 351,30 | 56320 x 1 + 56007 x 5 |
| 55677 | 364,80 | 56320 x 1 + 56008 x 5 |
| 55678 | 390,20 | 56320 x 1 + 56009 x 5 |
| 55679 | 428,90 | 56320 x 1 + 56010 x 5 |
| 55680 | 455,10 | 56320 x 1 + 56011 x 5 |
| 55681 | 477,00 | 56320 x 1 + 56012 x 5 |
| 55682 | 489,50 | 56320 x 1 + 56013 x 5 |
| 55683 | 540,90 | 56320 x 1 + 56014 x 5 |
| 55684 | 553,70 | 56320 x 1 + 56015 x 5 |

560x1750 mm



Estantería abierta

Rayonnage ouvertes · Offenes Regale
Open shelving · Estantes abiertas

3 Estantes · Shelf

| Ref | € | L (mm) | Desglose |
|-------|--------|--------|-----------------------|
| 55931 | 269,00 | 682 | 57317 x 1 + 57007 x 3 |
| 55932 | 276,60 | 794 | 57317 x 1 + 57008 x 3 |
| 55933 | 292,20 | 904 | 57317 x 1 + 57009 x 3 |
| 55934 | 328,70 | 1009 | 57317 x 1 + 57010 x 3 |
| 55935 | 343,90 | 1119 | 57317 x 1 + 57011 x 3 |
| 55936 | 359,70 | 1229 | 57317 x 1 + 57012 x 3 |
| 55937 | 374,80 | 1339 | 57317 x 1 + 57013 x 3 |
| 55938 | 404,10 | 1444 | 57317 x 1 + 57014 x 3 |
| 55939 | 420,80 | 1554 | 57317 x 1 + 57015 x 3 |

4 Estantes · Shelf

| Ref | € | Desglose |
|-------|--------|-----------------------|
| 55940 | 326,10 | 57317 x 1 + 57007 x 4 |
| 55941 | 336,00 | 57317 x 1 + 57008 x 4 |
| 55942 | 356,70 | 57317 x 1 + 57009 x 4 |
| 55943 | 405,20 | 57317 x 1 + 57010 x 4 |
| 55944 | 426,20 | 57317 x 1 + 57011 x 4 |
| 55945 | 445,10 | 57317 x 1 + 57012 x 4 |
| 55946 | 466,60 | 57317 x 1 + 57013 x 4 |
| 55947 | 507,80 | 57317 x 1 + 57014 x 4 |
| 55948 | 528,20 | 57317 x 1 + 57015 x 4 |

5 Estantes · Shelf

| Ref | € | Desglose |
|-------|--------|-----------------------|
| 55949 | 381,70 | 57317 x 1 + 57007 x 5 |
| 55950 | 394,50 | 57317 x 1 + 57008 x 5 |
| 55951 | 421,20 | 57317 x 1 + 57009 x 5 |
| 55952 | 481,90 | 57317 x 1 + 57010 x 5 |
| 55953 | 507,90 | 57317 x 1 + 57011 x 5 |
| 55954 | 533,50 | 57317 x 1 + 57012 x 5 |
| 55955 | 558,70 | 57317 x 1 + 57013 x 5 |
| 55956 | 610,10 | 57317 x 1 + 57014 x 5 |
| 55957 | 635,50 | 57317 x 1 + 57015 x 5 |



560x2000 mm

Estantería abierta

Rayonnage ouvertes · Offenes Regale
Open shelving · Estantes abiertas

3 Estantes · Shelf

| Ref | € | L (mm) | Desglose |
|-------|--------|--------|-----------------------|
| 55958 | 284,30 | 682 | 57320 x 1 + 57007 x 3 |
| 55959 | 291,90 | 794 | 57320 x 1 + 57008 x 3 |
| 55960 | 307,50 | 904 | 57320 x 1 + 57009 x 3 |
| 55961 | 343,60 | 1009 | 57320 x 1 + 57010 x 3 |
| 55962 | 359,70 | 1119 | 57320 x 1 + 57011 x 3 |
| 55963 | 374,80 | 1229 | 57320 x 1 + 57012 x 3 |
| 55964 | 389,90 | 1339 | 57320 x 1 + 57013 x 3 |
| 55965 | 420,80 | 1444 | 57320 x 1 + 57014 x 3 |
| 55966 | 436,10 | 1554 | 57320 x 1 + 57015 x 3 |

4 Estantes · Shelf

| Ref | € | Desglose |
|-------|--------|-----------------------|
| 55967 | 341,20 | 57320 x 1 + 57007 x 4 |
| 55968 | 351,00 | 57320 x 1 + 57008 x 4 |
| 55969 | 371,80 | 57320 x 1 + 57009 x 4 |
| 55970 | 420,50 | 57320 x 1 + 57010 x 4 |
| 55971 | 441,30 | 57320 x 1 + 57011 x 4 |
| 55972 | 461,70 | 57320 x 1 + 57012 x 4 |
| 55973 | 481,90 | 57320 x 1 + 57013 x 4 |
| 55974 | 523,00 | 57320 x 1 + 57014 x 4 |
| 55975 | 543,30 | 57320 x 1 + 57015 x 4 |

5 Estantes · Shelf

| Ref | € | Desglose |
|-------|--------|-----------------------|
| 55976 | 397,30 | 57320 x 1 + 57007 x 5 |
| 55977 | 409,90 | 57320 x 1 + 57008 x 5 |
| 55978 | 435,40 | 57320 x 1 + 57009 x 5 |
| 55979 | 497,20 | 57320 x 1 + 57010 x 5 |
| 55980 | 523,10 | 57320 x 1 + 57011 x 5 |
| 55981 | 548,40 | 57320 x 1 + 57012 x 5 |
| 55982 | 573,90 | 57320 x 1 + 57013 x 5 |
| 55983 | 625,10 | 57320 x 1 + 57014 x 5 |
| 55984 | 650,70 | 57320 x 1 + 57015 x 5 |

Organización y limpieza

Organization and cleaning



Cestas

PP
Polypropylene

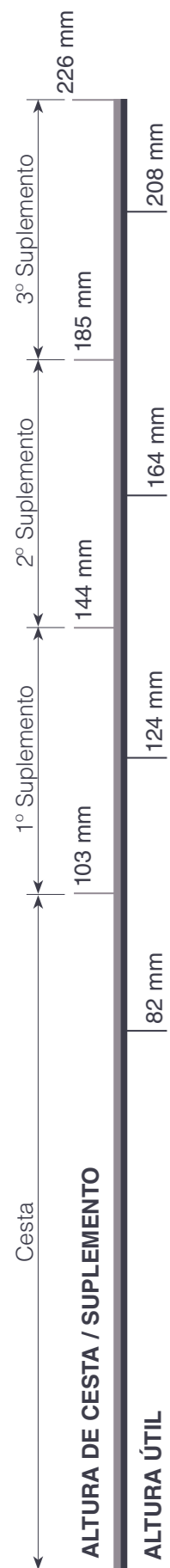

Verificador de diámetros

Vérifiez le diamètre · Chek the diameter · Diameter prufungen · Medidor de diámetros

| | | |
|-----------|------------------|------------|
| 49 | Compart. Teillen | 64x64 mm |
| 36 | Compart. Teillen | 75x75mm |
| 25 | Compart. Teillen | 90x90 mm |
| 16 | Compart. Teillen | 113x113 mm |

- La alta calidad de sus materiales hacen que la resistencia al calor y a los impactos sea óptima, por lo que su durabilidad está garantizada.
- Su sistema único de apilación permite un fácil montaje, y lo que es más novedoso, el desmontaje del mismo siempre que usted lo desee.
- Su estructura abierta permite una mayor rapidez en el lavado y secado debido a una mejor circulación de agua y del aire.
- El diseño de las asas hacen que su manejo y carga sean cómodos y sin riesgos. Además, para facilitar su manejo, está disponible un carro porta cestas útil para evitar esfuerzos en los desplazamientos.
- Adaptable a la mayoría de las cestas existentes en el mercado.

- La haute qualité de ses matériaux rend la résistance à la chaleur et les impacts optimaux, donc sa durabilité est garantie.
- Son système de pile unique permet un assemblage facile, et ce qui est plus nouveau, son démontage tant que vous le souhaitez.
- Sa structure ouverte permet plus rapidement de se laver et de sécher en raison d'une meilleure circulation d'eau et d'air.
- La conception des poignées rend leur manipulation et leur charge confortable et sans risques. De plus, pour faciliter sa gestion, une voiture de panier utile est disponible pour éviter les efforts des déplacements.
- Adaptable à la plupart des paniers existants sur le marché.

- The high quality of its materials makes heat resistance and impacts optimal, so its durability is guaranteed.
- Its unique stack system allows easy assembly, and what is more new, its disassembly as long as you want.
- Its open structure allows faster to wash and dry due to a better circulation of water and air.
- The design of the handles make their handling and load comfortable and without risks. In addition, to facilitate its management, a useful basket car is available to avoid efforts in the displacements.
- Adaptable to most of the existing baskets in the market.

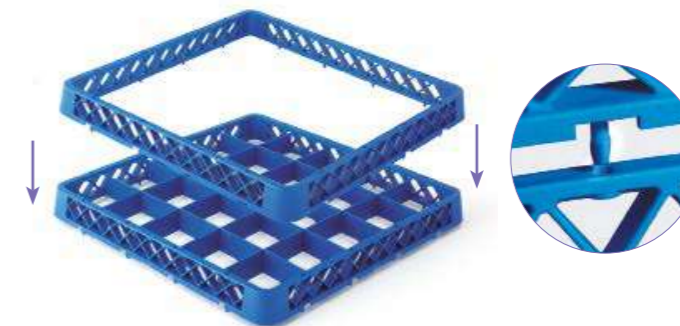

Sistema único de apilación, permite un fácil montaje
Unique folding system enables racks to be constructed

Cesta base

Casier universel · Spülkorb
Universal open rack · Cesta base

| Ref | € | cm | U.Venta |
|-------|--------------|----------|---------|
| 69235 | 33,70 | 35x35x12 | 1 |
| 69240 | 34,50 | 40x40x11 | 1 |



Cesta base universal

Casier universel · Universalspülkorb
Universal open rack · Cesta base universal

| Ref | € | cm | U.Venta |
|-------|--------------|------------|---------|
| 69250 | 25,60 | 50x50x10,3 | 1 |



Suplemento altura abierta

Réhausse sans compart. · Ergänzung
Universal open extender · Suplem. altura aberto

| Ref | € | cm | U.Venta |
|-------|--------------|-----------|---------|
| 69251 | 10,70 | 50x50x4,5 | 1 |



Cesta base 16 compartimentos

Casier 16 compartiments · Spülkorb 16-tlg.
Rack with 16 compartments · Cesta base 16 compart.

| Ref | € | cm | U.Venta |
|-------|--------------|------------|---------|
| 69214 | 30,70 | 50x50x10,3 | 1 |



Suplemento altura 16 compartimentos

Réhausse, 16 comp. · Ergänzung 16-tlg. Spülkorb
Extender for rack with 16 comp.. · Suplem. altura 16 compart.

| Ref | € | cm | U.Venta |
|-------|--------------|-----------|---------|
| 69217 | 13,10 | 50x50x4,5 | 1 |



Cesta base 25 compartimentos

Casier 25 compartiments · Spülkorb 25-tlg.
Rack with 25 compartments · Cesta base 25 compart.

| Ref | € | cm | U.Venta |
|-------|--------------|------------|---------|
| 69225 | 32,30 | 50x50x10,3 | 1 |



Suplemento altura 25 compartimentos

Réhausse, 25 comp. · Ergänzung 25-tlg. Spülkorb
Rack with 25 compart. · Suplem. altura 25 compart.

| Ref | € | cm | U.Venta |
|-------|--------------|-----------|---------|
| 69226 | 14,00 | 50x50x4,5 | 1 |



Cesta base 36 compartimentos

Casier 36 compartiments · Spülkorb 36-tlg.
Rack with 36 compartments · Cesta base 36 compart.

| Ref | € | cm | U.Venta |
|-------|--------------|------------|---------|
| 69236 | 34,00 | 50x50x10,3 | 1 |



Suplemento altura 36 compartimentos

Réhausse, 36 comp. · Ergänzung 36-tlg. Spülkorb
Extender for rack with 36 compart. · Suplem. altura 36 compart.

| Ref | € | cm | U.Venta |
|-------|--------------|-----------|---------|
| 69237 | 14,00 | 50x50x4,5 | 1 |





Cesta base 49 compartimentos

Casier 49 compartiments · Spülkorb 49-tlg.
Rack with 49 compartments · Cesta base 49 compart.

| Ref | € | cm | U.Venta |
|-------|-------|------------|---------|
| 69249 | 34,90 | 50x50x10,3 | 1 |



Suplemento altura 49 compartimentos

Réhausse, 49 comp. · Ergänzung 49-tlg. Spülkorb
Extender for rack w/49 compart. · Suplem. altura 49 compart.

| Ref | € | cm | U.Venta |
|-------|-------|-----------|---------|
| 69248 | 14,80 | 50x50x4,5 | 1 |



Cesta para platos

Casier pour assiettes · Tellerspülkorb
Small trays and dishes rack · Cesta para pratos

| Ref | € | cm | U.Venta |
|-------|-------|------------|---------|
| 69202 | 25,70 | 50x50x10,3 | 1 |



Cesta para platos Blue

Casier pour assiettes · Tellerspülkorb
Small trays and dishes rack · Cesta para pratos

| Ref | € | cm | U.Venta |
|-------|-------|----------|---------|
| 69234 | 34,20 | 35x35x12 | 1 |
| 69241 | 40,30 | 40x40x11 | 1 |



Cesta para platos/bandejas

Casier pour grands platex · Plattenspülkorb
Universal open side trays rack · Cesta pratos/bandejas

| Ref | € | cm | U.Venta |
|-------|-------|------------|---------|
| 69203 | 31,80 | 50x50x10,3 | 1 |

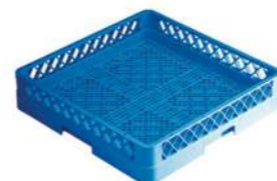

Cesta para cubiertos

Casier à couverts · Besteckspülkorb
Flatware/utensil rack · Cesta para talheres

| Ref | € | cm | U.Venta |
|-------|-------|------------|---------|
| 69204 | 25,30 | 50x50x10,3 | 1 |



Tapa cesta universal

Couvercle pour casier universel · Deckel für Universals Spülkorb
Standard rack's lid · Tapa cesta universal

| Ref | € | cm | U.Venta |
|-------|-------|-----------|---------|
| 69205 | 20,20 | 50x50x2,5 | 1 |

Soporte para platos

Support pour les plats · Tellerhalter
Plate holder · Suporte para pratos

| Ref | € | cm | Capacidad | U.Venta |
|-------|-------|------------|-----------|---------|
| 69207 | 10,00 | 31,0x9,5x7 | 15 platos | 1 |
| 69213 | 11,50 | 34,5x9,5x7 | 17 platos | 1 |



Cesta 8 compart. Cubiertos

Panier à couverts, 8 compart. · Besteckspülkorb 8 tlg.
Cutlery rack with 8 compart. · Cesta 8 compart. talheres

| Ref | € | cm | U.Venta |
|-------|-------|------------|---------|
| 69208 | 16,00 | 20,5x43x13 | 1 |



Cubilete cubiertos

Petit panier à couverts · Besteckbehälter
Cutlery cube · Cesta talheres

| Ref | € | cm | U.Venta |
|-------|------|----------------|---------|
| 69215 | 4,80 | 12,5x12,5x13,5 | 6 |



2 ruedas con freno incorporado
2 wheels with built-in brakes

Carro porta-cestas

Socle à roulettes pour casier · Transportwagen für Spuelkoerbe
Trolley for racks · Carro porta-cestas

| Ref | € | cm | L | U.Venta |
|-------|--------|----------|----------|---------|
| 69211 | 200,40 | 55x57x80 | 4 cestas | 1 |
| 69212 | 122,10 | 55x57x20 | 4 cestas | 1 |



Sin asa
Without handle



Dispensadores de jabón

PE

Polyethylene

- Perfecto para almacenar y dispensar geles desinfectantes, jabones, champús u otros materiales líquidos.
- Tamaño compacto; ideal para oficinas, hogares, restaurantes, etc.
- Ventana transparente que permite controlar la cantidad de líquido disponible.
- Diseñado para colocar en la pared y ahorrar espacio.
- Depósito extraíble para rellenar fácilmente.

- Parfait pour stocker et distribuer des gels désinfectants, des savons, des shampoings ou d'autres matériaux liquides.
- Format compact; idéal pour les bureaux, les maisons, les restaurants, etc.
- Fenêtre transparente qui vous permet de contrôler la quantité de liquide disponible.
- Conçu pour placer sur le mur et économiser de l'espace.
- Dépôt amovible à remplir facilement.

- Perfect to store and dispense disinfectant gels, soaps, shampoos or other liquid materials.
- Compact size; Ideal for offices, homes, restaurants, etc.
- Transparent window that allows you to control the amount of liquid available.
- Designed to place on the wall and save space.
- Removable deposit to fill easily.



Fácil de rellenar
Easy to fill



Fácil de rellenar
Easy to fill



SAN
Plastic

Dispensador de jabón/gel White

Distributeur de savon et gel · Seifen- und Gelspender
Soap and gel dispenser · Dispensador de sabão e gel

| Ref | € | L | U.Venta |
|-------|-------|------|---------|
| 91525 | 24,70 | 1,00 | 1 |

Dispensadores de jabón/gel

Distributeur de savon et gel · Seifen- und Gelspender
Soap and gel dispenser · Dispensador de sabão e gel

| Ref | € | ml | U.Venta |
|---------|-------|-----|---------|
| A 91520 | 12,20 | 350 | 1 |
| B 91521 | 11,10 | 350 | 1 |

A

B

C



Altura regulable
Máx: 150 cm / Min: 105 cm
Adjustable height
Max: 150 cm / Min: 105 cm

- Permite ubicar el dispensador de gel en cualquier lugar, sin necesidad de depender de ninguna pared o superficie vertical.
- Altura regulable. Máx: 150 cm / Min: 105 cm.
- Apto para gel hidroalcohólico y jabón líquido.
- Funcionamiento con sensor, detección entre 5-9 cm de altura.
- Opción de ajustar el caudal entre 0,5 y 2,5 ml.
- Ideal para zonas de gran movimiento de gente.

- Il permet de localiser le distributeur de gel n'importe où, sans avoir besoin de dépendre d'une surface murale ou verticale.
- Hauteur réglable. Max: 150 cm / min: 105 cm.
- Convient pour le gel hydroalcoolique et le savon liquide.
- Fonctionnement du capteur, détection entre 5 à 9 cm de haut.
- Option pour ajuster le débit entre 0,5 et 2,5 ml.
- Idéal pour les zones de grand mouvement de personnes.

- It allows to locate the gel dispenser anywhere, without the need to depend on any wall or vertical surface.
- Adjustable height. Max: 150 cm / min: 105 cm.
- Suitable for hydroalcoholic gel and liquid soap.
- Sensor operation, detection between 5-9 cm high.
- Option to adjust the flow between 0.5 and 2.5 ml.
- Ideal for areas of great movement of people.

Soporte dispensador de gel

Support distributeur de gel · Gelspenderhalter
Gel dispenser holder · Suporte dispensador de gel

| Ref | € | h(cm) | U.Venta |
|---------|--------|-------|---------|
| A 91540 | 73,00 | 160 | 1 |
| B 91541 | 153,30 | 160 | 1 |
| C 91542 | 153,30 | 160 | 1 |

Fácil de rellenar - Easy to fill

Soporte · Support

Plata · Silver

Blanco · White



Papeleras

INOX
18/10

Papelera sobremesa
Poubelle de table · Tisch-Abfallbehälter
Table bin · Papeleira de mesa

| Ref | € | Ø (cm) | h(cm) | L | U.Venta |
|-------|-------|--------|-------|------|---------|
| 63302 | 24,80 | 12 | 16 | 1,20 | 1 |



Sistema de cierre SoftClosing
Cubeta interior extraíble de polipropileno con asa
Closing system SoftClosing
It has a removable polypropylene inner liner with a handle

INOX

Papelera con pedal
Poubelle à pédale · Tret-Abfallbehälter
Pedal bin · Papeleira com pedal

| Ref | € | Ø (cm) | h(cm) | L | U.Venta |
|-------|-------|--------|-------|-----|---------|
| 63307 | 23,90 | 16,8 | 25 | 3,0 | 1 |

INOX

Papalera con pedal Inox
Poubelle à pédale · Tret-Abfallbehälter
Pedal bin · Papeleira com pedal

| Ref | € | Ø (cm) | h(cm) | L | U.Venta |
|-------|-------|--------|-------|------|---------|
| 63303 | 22,70 | 17,0 | 25,5 | 3,0 | 1 |
| 63305 | 29,70 | 20,5 | 28,0 | 5,0 | 1 |
| 63312 | 43,90 | 25,0 | 40,0 | 12,0 | 1 |
| 63319 | 62,90 | 29,0 | 45,0 | 20,0 | 1 |



Sistema de cierre SoftClosing
Cubeta interior extraíble de polipropileno con asa
Closing system SoftClosing
It has a removable polypropylene inner liner with a handle

FE
Iron

Papelera con pedal Nature
Poubelle à pédale · Tret-Abfallbehälter
Pedal bin · Papeleira com pedal

| Ref | € | Ø (cm) | h(cm) | L | U.Venta |
|---------|-------|--------|-------|-----|---------|
| A 63335 | 56,30 | 20,5 | 27,6 | 5,0 | 1 |
| B 63355 | 56,30 | 20,5 | 27,6 | 5,0 | 1 |

Recogemigas

INOX



Cepillo recogemigas
Ramasse-miettes à rouleaux · Krümelbürste
Crumbs cleaner · Escova apanha-migalhas

| Ref | € | cm | h(cm) | U.Venta |
|-------|-------|----------|-------|---------|
| 64407 | 15,10 | 9,5x16,5 | 4,0 | 1 |

INOX
18/10



Cepillo recogedor Hiperluxe
Ramasse-miettes à rouleaux · Krümelbürste
Crumbs cleaner · Escova apanha-migalhas

| Ref | € | cm | U.Venta |
|-------|-------|---------|---------|
| 64408 | 51,10 | 14,5x17 | 1 |

INOX
18/10



Cepillo recogedor Luxe
Ramasse-miettes · Krümelbürste
Crumbs cleaner · Espátula apanha-migalhas

| Ref | € | cm | U.Venta |
|-------|-------|------|---------|
| 64409 | 31,70 | 22x7 | 1 |

Portarollos de cocina

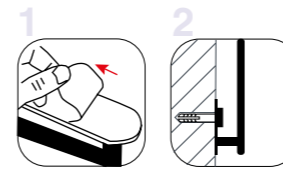

2 opciones para instalar
2 options to install

INOX

Portarollos de cocina Black
Derouleur de cuisine · Küchenrollenspender
Dispenser for kitchen · Porta-rolos cozinha

| Ref | € | cm | h(cm) | U.Venta |
|-------|-------|----------|-------|---------|
| 62289 | 14,90 | 33,5x4,5 | 8 | 1 |

INOX
18/10

Pie portarollos
Dérouteur pour papier essuie-tout · Spänder für Küchenrolle
Kitchen roll dispenser stand · Pé porta-rolos

| Ref | € | Ø (cm) | h(cm) | U.Venta |
|-------|-------|--------|-------|---------|
| 50301 | 20,40 | 15 | 32,5 | 6 |



- Fabricado en acero inoxidable de alta calidad, acabado negro mate.
- Duradero y resistente, a prueba de óxido.
- Diseño moderno y elegante. Capacidad: 1 rollo de cocina (longitud de rollos: 30 cm y 6 cm de grosor).
- Perfecto para colocar el papel de cocina y mantener la encimera despejada.
- Fácil de instalar. Opción de colocar mediante papel adhesivo o perforado con tornillos (ambos incluidos).
- Se puede instalar vertical u horizontalmente según las necesidades.

- Made of high quality stainless steel, matt black finish.
- Durable and resistant, oxide proof.
- Modern and elegant design. Capacity: 1 kitchen roll (roll length: 30 cm and 6 cm thick).
- Perfect to place the kitchen and keep the countertop clear.
- Easy to install. Option to place by adhesive or perforated paper with screws (both included).
- It can be installed vertically or horizontally depending on the needs.



Perfecto para colocar el papel de cocina y mantener la encimera despejada.
Perfect to place the kitchen and keep the countertop clear.

Base contrapeso
Counterbalance base
1 Kg



Bobina aluminio
Rouleau aluminium · Aluminiumfolie
Aluminium foil · Bobina aluminio

| Ref | € | Film (m) | Micras | U.Venta |
|-------|--------------|----------|--------|---------|
| 10330 | 56,70 | 0,30x300 | 11 | 1 |
| 10430 | 69,70 | 0,40x300 | 11 | 1 |

Rollos aptos para los portarrollos · Rolls suitable for multiroll dispenser

| Ref. | Film transparente · Transparent film | Rollo aluminio · Aluminium foil | Rollo papel · Paper roll |
|-------|--------------------------------------|---------------------------------|--------------------------|
| 60701 | Ø50x320 mm | Ø50x320 mm | Ø180x330 mm |
| 60702 | Ø48x340 mm | Ø60x340 mm | Ø170x330 mm |

INOX
18/10

Portarrollos de cocina pared

Derouleur de cuisine · Küchenrollenspender
Multiroll dispenser for kitchen · Porta-rolos cozinha de parede

| Ref | € | Medidas | U.Venta |
|----------------|--------------|--------------------|---------|
| A 60701 | 60,40 | 37,7 x 30 x 8,95 | 6 |
| B 60702 | 56,90 | 37,5 x 23,9 x 9,72 | 8 |



INOX

Servilletero bar

Distributeur de serviettes bar · Serviettenspender bar
Bar napkin holder · Guardanapo bar

| Ref | € | cm | Medidas Servilleta | U.Venta |
|-------|-------------|----------|--------------------|---------|
| 61002 | 9,70 | 9,5x13,5 | 90x125 | 4 |

- Cuchillas de acero inoxidable intercambiables.
- Se utiliza para raspar los residuos de los alimentos y el carbón de las planchas.
- Interchangeable stainless steel blades.
- Used to scrape food and charcoal residue from grills.
- Ergonomic design with two hand-holds.



AL FUNDIDO INOX
Aluminium Cast

Rasqueta profesional para grill

Racloir professionnel pour grill · Professioneller grillschaber
Professional grill scraper · Raspador profesional para grill

| Ref | € | Cuchilla (cm) | Medidas | U.Venta |
|-------|--------------|---------------|-------------|---------|
| 67034 | 72,60 | 15 | 42x15x12 cm | 1 |

Bobina film transparente

Rouleau film transparent · Frischhaltefolie
Transparent cling film · Bobina filme transparente

| Ref | € | Film (m) | Micras | U.Venta |
|-------|--------------|----------|--------|---------|
| 11330 | 14,50 | 0,30x300 | 10 | 1 |
| 11430 | 22,40 | 0,45x300 | 10 | 1 |

- Alfombrilla escurreplatos fabricada en silicona de máxima calidad. Libre de BPA.
- Diseñada para posar la vajilla, vasos, copas, tazas, etc.
- Maximiza el drenaje y la ventilación gracias a su diseño en relieves.
- Antideslizante y antibacteriana. Fácil de limpiar y apto para el lavavajillas.
- Flexible y enrollable. Incluye un orificio para colgar.
- Resistente a altas temperaturas.

- Dish drainer mat made of top quality silicone. BPA free.
- Designed to hold crockery, glasses, cups, etc.
- Maximises drainage and ventilation thanks to its relief design.
- Anti-slip and anti-bacterial. Easy to clean and dishwasher safe.
- Flexible and rollable. Includes a hole for hanging.
- High temperature resistant.



Escurreplatos de silicona

Tapis égouttoir en silicone · Abtropfmatte aus Silikon
Silicone dish mat · Escorredor para pratos de silicona

| Ref | € | cm | U.Venta |
|-------|--------------|---------|---------|
| 66774 | 18,20 | 42,5x32 | 1 |

Ceniceros

INOX
18/10

- Cenicero para pared exterior. Cerradura con llave.
- Incluye material para fijación y una llave triangular.
- Cajetín interior de acero galvanizado extraíble para facilitar su limpieza.

- Cendrier du mur extérieur. Verrouiller avec la clé.
- Comprend la fixation du matériau et une clé triangulaire.
- Acier intérieur galvanisé en acier amovible pour faciliter le nettoyage.

- Outdoor wall ashtray. Lock with key.
- Includes fixing material and a triangular key.
- Steel inner galvanized steel removable to facilitate cleaning.



Colocación en pared
Wall mounting

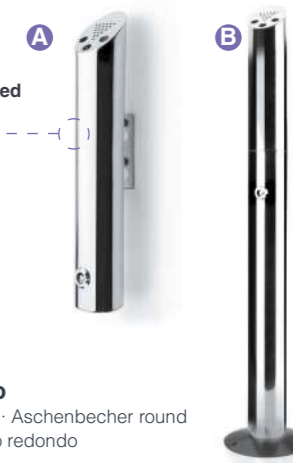

Cenicero redondo

Cendrier extérieur rond · Aschenbecher round
Round ash try · Cinzeiro redondo

| Ref | € | Ø (cm) | L | U.Venta |
|----------------|---------------|--------|------|---------|
| A 63331 | 93,50 | 8x46 | 1,70 | 1 |
| R63331A | 4,00 | - | - | 1 |
| B 63332 | 149,50 | 8x92 | 1,50 | 1 |
| R63332A | 4,00 | - | - | 1 |

Llave
Key

Cenicero pared

Mural cendrier · Wand aschenbecher
Wall ash try · Cinzeiro de parede

| Ref | € | cm | h(cm) | U.Venta |
|----------------|--------------|---------|-------|---------|
| A 63341 | 89,40 | 24,5x35 | 14 | 1 |
| B 63342 | 83,70 | 25x35 | 8,5 | 1 |

Postes separadores Black

FE INOX
Iron

- Ideal para la gestión de colas o separación de espacios.
- Estructura fabricada en hierro con recubrimiento de color negro.
- Cinta extensible retráctil de 2 m de longitud.
- Fácil de fijar y soltar las conexiones.

- Idéal pour la gestion des files d'attente ou la séparation des espaces.
- Structure en fer avec revêtement noir.
- Bande extensible rétractable de 2 m de long.
- Connexions faciles à fixer et à détacher.

- Ideal for queue management or space separation.
- Structure made of iron with black coating.
- Retractable extensible tape 2 m long.
- Easy to fix and release connections.

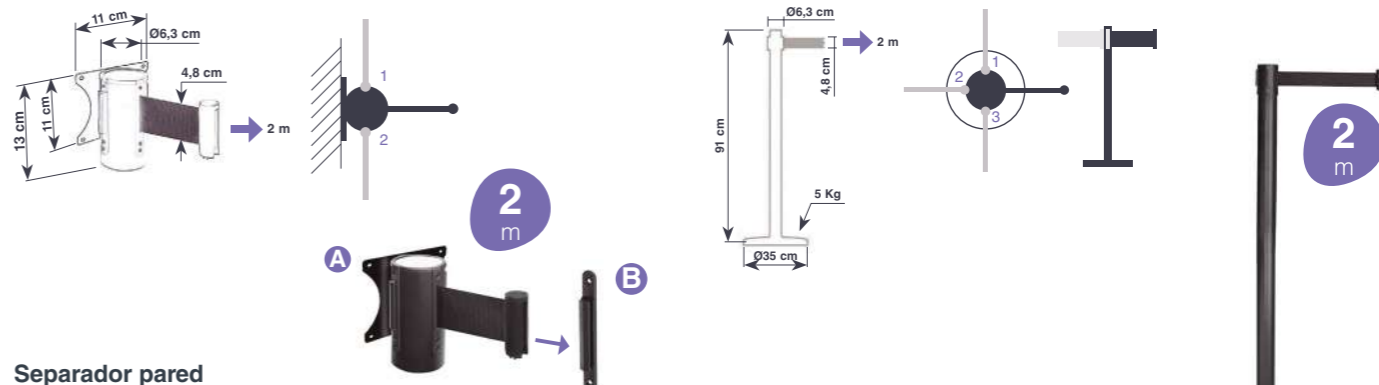

Separador pared

Séparateur mural · Wandtrennpfosten
Wall separator · Separador de parede

| Ref | € | Metros | U.Venta |
|------------------|--------------|--------|---------|
| A 91530 | 37,60 | 2 | 1 |
| B R91533A | 1,80 | - | 1 |

Incluye R91533A · Included)
Apta para la ref.91533
Suitable for ref.91533

Poste separador

Poteau séparateur · Trennpfosten
Separator post · Poste separador

| Ref | € | Metros | Medidas | U.Venta |
|-------|--------------|--------|-----------|---------|
| 91533 | 58,40 | 2 | Ø35x91 cm | 1 |

06

Eléctrico
Electric





Arroceras



Household use

- **Cubeta interna extraíble con recubrimiento antiadherente 100% ECO y libre de PFOA.**
- **Cestillo de vapor removible para cocer verduras, patatas, pescado, etc.**
- **Incluye cuchara y vaso medidor.**
- **Tapa fabricada en vidrio con salida de vapor para evitar la cocción excesiva de los alimentos.**
- **Función de conservación del calor y protección contra la ebullición en seco.**
- **Luces indicadoras para cocinar y mantener caliente.**
- **100% estable gracias a sus pies antideslizantes.**
- **Muy fácil de limpiar.**

- Bodet interne amovible avec écho 100% et revêtement anti-tinétaire gratuit.
- Panier à vapeur amovible pour la cuisson des légumes, des pommes de terre, du poisson, etc.
- Comprend du verre à la cuillère et au compteur.
- Couvrir en verre avec une puissance à la vapeur pour éviter une cuisson alimentaire excessive.
- Fonction de conservation de la chaleur et protection contre l'ébullition à sec.
- Les voyants pour la cuisson et le respect.
- 100% stable grâce à leurs pieds non glissants.
- Très facile à nettoyer.

- Removable internal bucket with 100% echo and free antiating coating.
- Removable steam basket for cooking vegetables, potatoes, fish, etc.
- Includes spoon and meter glass.
- Cover made of glass with steam output to avoid excessive food cooking.
- Heat conservation function and protection against dry boiling.
- Indicator lights for cooking and keeping hot.
- 100% stable thanks to their non-slip feet.
- Very easy to clean.

Professional use



Arroceras

Cuiseur à riz · Reiskocher
Rice cooker · Arrozeira/vaporeira

| | Ref | € | W | Capacidad | Raciones | U.Venta |
|---|---------|--------|------|-----------|----------|---------|
| A | 69441 | 47,00 | 400 | 1,0 L | 5 | 1 |
| | 69233 | 53,90 | 700 | 1,8 L | 10 | 1 |
| B | 69346 | 192,20 | 1300 | 3,6 L | 20 | 1 |
| | R69346F | 15,30 | - | - | - | 1 |

Vaporera · Steam



Cocedor de huevos Tri & Six Ovum



Household use

- **Fabricado con base de acero inoxidable 18/10 y tapa transparente libre de BPA.**
- **Diseñado para cocinar huevos de diferentes tamaños y en 3 formas diferentes: huevo duro, huevo mollet o huevo pasado por agua.**
- **Capacidad para cocer hasta 3 huevos a la vez.**
- **Apagado automático y señal acústica automática al terminar el proceso de cocción.**
- **Incluyen un vaso medidor (70 ml) con perforador que indica la cantidad de agua que hay que introducir.**
- **Totalmente desmontable y muy fácil de limpiar.**

- Fabriqué avec un couvercle transparent en acier inoxydable 18/10 et sans BPA.
- Conçu pour la cuisson des œufs de différentes tailles et de 3 manières différentes: œuf dur, œuf mollet ou œuf passé par l'eau.
- Capacité à cuire jusqu'à 3 œufs en même temps.
- Signal acoustique automatique et automatique à la fin du processus de cuisson.
- Ils comprennent un récipient de mesure (70 ml) avec perforateur qui indique la quantité d'eau à introduire.
- Entièrement amovible et très facile à nettoyer.

- Manufactured with 18/10 stainless steel and BPA-free transparent lid.
- Designed for cooking eggs of different sizes and in 3 different ways: hard egg, mollet egg or egg past by water.
- Capacity to cook up to 3 eggs at the same time.
- Automatic off and automatic acoustic signal at the end of the cooking process.
- They include a meter vessel (70 ml) with perforator that indicates the amount of water to be introduced.
- Fully removable and very easy to clean.



Click here



Cocedor de huevos Tri Ovum

Cuiseur à oeufs · Eierkocher
Egg cooker · Máquina de cozer ovos

| Ref | € | W | Capacidad | Medidas | U.Venta |
|-------|-------|-----|-----------|----------------|---------|
| 69343 | 24,60 | 210 | 3 huevos | 20x8,5x13,5 cm | 1 |

Cocedor de huevos Six Ovum

Cuiseur à oeufs · Eierkocher
Egg cooker · Máquina de cozer ovos

| Ref | € | W | Capacidad | Medidas | U.Venta |
|-------|-------|-----|-----------|---------------|---------|
| 69344 | 35,30 | 210 | 6 huevos | 23,5x13x14 cm | 1 |

Cocedor y asador de Salchichas

INOX   Professional use

- Fabricada en acero inoxidable de alta calidad.
- Ideal para cocinar al vapor salchichas, mazorcas de maíz, etc.
- Amplia cubeta de cristal y 3 pinchos para calentar los panecillos o bollos.
- Termostato regulable. Calentamiento rápido y efectivo.
- Dos interruptores independientes para cocinar simultáneamente o por separado las salchichas y los panes.
- NO necesita aceite ni grasa.
- Pies de goma antideslizantes para una mayor estabilidad.

- Fabriqué en acier inoxydable de haute qualité.
- Idéal pour les saucisses à la vapeur, les épis de maïs, etc.
- Grand seau en verre et 3 brochettes pour chauffer les rouleaux ou les petits pains.
- Thermostat réglable. Réchauffement rapide et efficace.
- Deux commutateurs indépendants pour cuisiner simultanément ou séparément des saucisses et des pains.
- Il n'a pas besoin d'huile ou de graisse.
- Pieds en caoutchouc non glissants pour une plus grande stabilité.

- Made of high quality stainless steel.
- Ideal for steamed sausages, corn cobs, etc.
- Large glass bucket and 3 skewers to heat the rolls or buns.
- Adjustable thermostat. Fast and effective warming.
- Two independent switches to cook simultaneously or separately sausages and breads.
- It does not need oil or fat.
- Non-slip rubber feet for greater stability.



Cocedor de salchichas

Machine à hot-dogs · Hot dog Wärmer
Sausage cooker · Máquina de cozer salsichas

| Ref | € | W | Capacidad | Altura tubos pan | Cestillo | Medidas | U.Venta |
|-------|--------|-----|-----------|------------------|-----------|---------------|---------|
| 69543 | 476,70 | 540 | 1,0 L | 18 cm | Ø17x21 cm | 24x50x38,5 cm | 1 |



Asador de Salchichas

Grill à hot-dogs · Würstchengrill
Sausage roaster · Assador de salsichas

| Ref | € | W | Tubos | Distancia entre tubos | Medidas | U.Venta |
|-------|--------|-----|-----------|-----------------------|---------------|---------|
| 69547 | 535,00 | 590 | 7 (50 cm) | 1cm | 65x35,5x28 cm | 1 |



Panificadora White

     Household use

- 12 programas y 3 niveles de tostado.
- Totalmente automática: mezcla, amasa, fermenta y hornea.
- Molde con revestimiento antiadherente extraíble de máxima calidad, ecológica y libre de PFOA.
- Programas especiales para preparar pan sin gluten, masa de pasta o pizza, etc.
- Función de mantenimiento en caliente durante 1 hora tras cada programa.
- Capacidad: 700 g o 1 KG.
- Panel de control LCD.
- Temporizador de 13 horas.
- Ventana transparente para controlar el proceso de horneado.
- Accesorios: varilla amasadora, vaso, cuchara medidora y gancho.
- Incluye libro de recetas elaborado en exclusiva para nuestra panificadora.

- 12 programmes et 3 niveaux grillés.
- Entièrement automatique: mélanger, pétrir, fermenter et cuire.
- Moule avec revêtement anti-amovible de la plus haute qualité, écologique et exempt de PFOA.
- Programmes spéciaux pour préparer du pain sans gluten, des pâtes ou de la pâte à pizza, etc.
- Fonction d'entretien à chaud pendant 1 heure après chaque programme.
- Capacité: 700 g ou 1 kg.
- Panneau de commande LCD.
- 13 -Hour temporisateur.
- Fenêtre transparente pour contrôler le processus cuit au four.
- Accessoires: pie de pie, verre, supposition de mesuration et crochement.
- Comprend un livre de recettes exclusivement préparé pour notre boulangerie.

- 12 programs and 3 toasted levels.
- Fully automatic: mix, knead, fermenta and bake.
- Mold with removable antiating coating of highest quality, ecological and free of PFOA.
- Special programs for preparing gluten-free bread, pasta or pizza dough, etc.
- Hot maintenance function for 1 hour after each program.
- Capacity: 700 g or 1 kg.
- LCD control panel.
- 13-hour timer.
- Transparent window to control the baked process.
- Accessories: kneading rod, glass, measuring spoon and hook.
- Includes recipe book exclusively prepared for our bakery.



Panificador White

Machine à pain · Brotbackmaschine
Bread-making machine · Máquina de fazer pão

| Ref | € | W | Capacidad | Tiempo | Funciones | Medidas | U.Venta |
|-------|--------|-----|-----------|----------|-----------|---------------|---------|
| 69334 | 146,60 | 550 | 1,0 L | 13 horas | 12 | 36x24,5x28 cm | 1 |



Yogurteras

VIDRIO Glass PP Polypropylene Healthy BPA free Cooking CE ROHS Household use

- Diseñada para elaborar yogur casero de la textura y sabor que desees.
- Práctica y muy fácil de usar. Supersilenciosa.
- Tiempo de preparación de 8-14 h.
- Apagado automático con señal acústica al finalizar el proceso.
- Incluye un práctico recetario para elaborar todo tipo de yogures.

- Conçu pour faire de la texture maison et du yaourt à la saveur que vous voulez.
- Pratique et très facile à utiliser. Supersilenciosa.
- Temps de préparation de 8 à 14 h.
- Automatique avec un signal acoustique à la fin du processus.
- Il comprend un livre de recettes pratiques pour élaborer tous les types de yaourts.

- Designed to make homemade texture and flavor yogurt you want.
- Practice and very easy to use. Supersilenciosa.
- Preparation time of 8-14 h.
- Automatic off with acoustic signal at the end of the process.
- It includes a practical recipe book to elaborate all types of yogurts.



Yogurtera de vasos Multi

Yaourtière à pots · Joghurt-Maker mit Glasbehältern
Yoghurt maker with jars · logurteira de frascos

| Ref | € | W | Capacidad | Tiempo | Medidas | U.Venta |
|-------|-------|----|------------|--------------|-----------|---------|
| 69245 | 46,60 | 20 | 7 x 190 ml | 1 - 14 horas | Ø25x12 cm | 1 |



VIDRIO Glass PP Polypropylene

Set 7 tarros Multi

Set 7 bocaux · 7-Tlg. Gläser ein
Set 7 jars · Conjunto de 7 potes

| Ref | € | Capacidad | U.Venta |
|-------|-------|-----------|---------|
| 69244 | 11,20 | 7x190ml | 7 |



PP Polypropylene



Yogurtera White

Yaourtière · Joghurt-Maker
Yoghurt maker · logurteira

| Ref | € | W | Capacidad cestillo | Capacidad jarra grande | Capacidad jarra pequeña | Medidas | U.Venta |
|-------|-------|----|--------------------|------------------------|-------------------------|-------------|---------|
| 69246 | 40,70 | 20 | 1 L (filtro) | 1,8 L | 1,6 L | 18x16x24 cm | 1 |



PP Polypropylene



Yogurtera Maxi

Yaourtière · Joghurt-Maker
Yoghurt maker · logurteira

| Ref | € | W | Capacidad | Medidas | U.Venta |
|-------|-------|----|-----------|-----------|---------|
| 69243 | 41,60 | 20 | 2,0 L | Ø20x23 cm | 1 |

PP Polypropylene



Yogurtera Hera

Yaourtière · Joghurt-Maker
Yoghurt maker · logurteira

| Ref | € | W | Capacidad | Medidas | U.Venta |
|-------|-------|----|-----------|---------------|---------|
| 69345 | 39,90 | 20 | 1,0 L | Ø16,8x18,8 cm | 1 |



Yogurtera de vasos Deva

Yaourtière à pots · Joghurt-Maker mit Glasbehältern
Yoghurt maker with jars · logurteira de frascos

| Ref | € | W | Capacidad | Rango temperatura | Medidas | U.Venta |
|-------|-------|----|-----------|-------------------|--------------|---------|
| 69439 | 61,80 | 40 | 170ml x 9 | 1-99h | 26x24,6x13,5 | 1 |



VIDRIO Glass PP Polypropylene

Set 9 tarros Deva

Set 9 bocaux · 9-Tlg. Gläser ein
Set 9 jars · Conjunto de 9 potes

| Ref | € | Capacidad | U.Venta |
|-------|-------|-----------|---------|
| 69438 | 15,80 | 9x170 ml | 9 |



Máquinas de helado

INOX
18/10



Household use

- Una nueva forma de hacer helados cremosos y saludables.
- Puedes realizar infinidad de helados; fresa, plátano, kiwi, mango, piña, melón, etc.
- Ideal para dietas especiales: sin leche, sin azúcar, sin gluten.

- Une nouvelle façon de faire de la crème glacée crémeuse et saine.
- Vous pouvez effectuer d'innombrables glaces; Fraise, banane, kiwi, mangue, ananas, melon, etc.
- Idéal pour les régimes spéciaux: sans lait, sans sucre, sans gluten.

- A new way of doing creamy and healthy ice cream.
- You can perform countless ice cream; Strawberry, banana, kiwi, mango, pineapple, melon, etc.
- Ideal for special diets: without milk, without sugar, gluten without.



Corta vegetales + Máquina de helado Cosmo

Hachoir légumes + machine à fruitcreme glacée · Gemüseschneider + Obst-Eis machine
Vegetables cutter + ice fruit machine · Corta vegetales + máq. de helado de fruta

| Ref | € | W | Cuchillas | Medidas | U.Venta |
|-------|-------|-----|-----------|-------------------|---------|
| 69115 | 82,50 | 150 | 6 | 24,5x22,5x19,5 cm | 1 |



Accesorio para helado de frutas
Fruit ice cream accessory

2 en 1

5 cuchillas de colores
5 colored blades



new



- Fabricada en acero inoxidable de gran calidad.
- Equipado con un potente compresor profesional de 150 W que permite preparar helado sin pre-congelar previamente el recipiente o los ingredientes.
- Versátil: Diseñado para elaborar helado, sorbete, yogur helado, etc. Personaliza tus recetas al 100%.
- Contenedor térmico extraíble fabricado en aluminio y capacidad de 1,5L.
- Función COOL: mantiene el helado frío durante una hora después de terminar el proceso.
- Intuitivo y sencillo de usar. Regula el tiempo de preparación de 5 a 90 minutos.
- Tapa transparente con un orificio para controlar el proceso o añadir ingredientes sin necesidad de abrir la heladera.
- Incorpora 2 paletas de mezcla especializadas para conseguir la textura idónea.
- Fácil limpieza: Todos los componentes de fabricación son desmontables, lo que permite una limpieza individual. Los accesorios son extraíbles y la tapa y las palas se pueden lavar en el lavavajillas.

- Equipped with a powerful 150 W professional compressor which allows you to prepare ice cream without pre-freezing the container or ingredients beforehand.
- Versatile: Designed to make ice cream, sorbet, frozen yoghurt, etc. Customise your recipes 100%.
- Removable thermal container made of aluminium with a capacity of 1.5L.
- COOL function: keeps the ice cream cold for one hour after the process is finished.
- Intuitive and easy to use. Regulates the preparation time from 5 to 90 minutes.
- Transparent lid with a hole to control the process or add ingredients without opening the ice cream maker.
- Incorporates 2 specialised mixing paddles to achieve the ideal texture.
- Easy cleaning: All manufacturing components are removable, allowing individual cleaning. The accessories are removable and the lid and blades are dishwasher safe.

Máquina de helados Artic

Machine de crème glacée · Eis Maschine
Ice cream machine · Máquina degelado

| Ref | € | W | Capacidad | Rango temperatura | Medidas | U.Venta |
|-------|--------|-----|-----------|-------------------|-------------|---------|
| 69306 | 390,60 | 150 | 1,50 L | Hasta -25°C | 43x29x24 cm | 1 |



Incluye
cuchara medidora
Measuring spoon
included

Sistema de
cocción por aire
caliente
Hot air cooking
system

Sin aceite
Without Oil

Palomitera

PC
Polycarbonate



Household use

- Prepara palomitas saludables sin necesidad de utilizar aceite, gracias a su sistema de cocción por aire caliente.
- Palomitas recién hechas en tan solo 3 minutos.
- Capaz de cocinar hasta 80 g de maíz por cada ciclo de trabajo.
- Incluye cuchara medidora para el maíz que te ayudará a calcular las raciones.
- Interruptor de encendido / apagado. Pies antideslizantes.

- Préparez du pop-corn sain sans utiliser d'huile, grâce à son système de cuisson à l'air chaud.
- Je viens de faire du pop-corn en seulement 3 minutes.
- Capable de cuisiner jusqu'à 80 g de maïs pour chaque cycle de travail.
- Comprend une cuillère de mesure pour le maïs qui vous aidera à calculer les parties.
- Interrupteur d'allumage / désactivé. Pieds non glissants.

- Prepare healthy popcorn without using oil, thanks to its hot air cooking system.
- Just made popcorn in just 3 minutes.
- Capable of cooking up to 80 g of corn for each work cycle.
- Includes a measurement spoon for corn that will help you calculate the portions.
- Ignition / off switch. Non -slip feet.



Palomitera

Machine à pop-corn · Popcorn-Maschine
Popcorn maker · Máquina de fazer pipocas

| Ref | € | W | Capacidad | Medidas | U.Venta |
|-------|-------|------|-----------|-----------------|---------|
| 69299 | 39,50 | 1000 | 80g | 14,5x21,5x30 cm | 1 |

Batidoras amasadoras



- Batir, mezclar y amasar productos para la preparación de alimentos.
- Velocidad regulable, doble movimiento de giro, rotativo y orbital.
- Brazo basculante para acoplar los distintos accesorios.

- Battre, mélanger et pétrir les produits pour la préparation des aliments.
- Vitesse réglable, double virage, mouvement rotatif et orbital.
- Slipping ARM pour fixer les différents accessoires.

- Beat, mix and knead products for food preparation.
- Adjustable speed, double turn, rotating and orbital movement.
- Slipping arm to attach the different accessories.



Batidora amasadora Profesional

Batteur pétrisseur · Mix- und Knetmaschine
Mixer-kneader · Batedeira amassadora

| Ref | € | W | Capacidad | Velocidad | Niveles potencia | Medidas | U.Venta |
|-------|--------|-----|-----------|-------------|------------------|-----------------|---------|
| 69084 | 888,10 | 300 | 5,0 L | 130-850 rpm | 3 | 24x36,5x41,5 cm | 1 |

- Regulador de velocidad para 6 velocidades y función PULSE (Turbo).
- Amasado con movimientos planetarios. Doble movimiento de giro, rotatorio y orbital.
- Brazo basculante de 35° para acoplar los distintos accesorios.
- Tapa transparente anti-salpicaduras con ventana para añadir ingredientes durante el uso

- Régulateur de vitesse pour 6 vitesses et fonction d'impulsion (Turbo).
- Pétrifié avec des mouvements planétaires. Double virage, mouvement rotatif et orbital.
- 35° Bran incliné pour fixer les différents accessoires.
- Couvercle anti-apphine transparent avec fenêtre pour ajouter des ingrédients pendant l'utilisation

- Speed regulator for 6 speeds and Pulse function (turbo).
- Kneaded with planetary movements. Double turn, rotary and orbital movement.
- 35° tilting arm to attach the different accessories.
- Transparent anti-sapphire cover with window to add ingredients during use



Batidora amasadora Gourmet

Batteur pétrisseur · Mix- und Knetmaschine
Mixer-kneader · Batedeira amassadora

| Ref | € | W | Capacidad | Velocidad | Niveles de velocidad | Medidas | U.Venta |
|-------|--------|-----|-----------|------------|----------------------|-------------|---------|
| 69388 | 217,30 | 600 | 4,0 L | 60-180 rpm | 6 | 22x35x30 cm | 1 |

Professional use



- 5 velocidades ajustables con función turbo y sistema de rotación planetaria.
- Mecanismo de engranajes metálicos.
- Bol de acero inoxidable de 5 L de máxima calidad.
- Tapa transparente anti salpicaduras con ventana.
- 5 adjustable speeds with turbo function and planetary rotation system.
- Metal gear mechanism.
- 5 L's stainless steel bowl.
- Transparent anti splashes with window.



Batidora amasadora Delicy

Batteur pétrisseur · Mix- und Knetmaschine
Mixer-kneader · Batedeira amassadora

| Ref | € | W | Capacidad | Velocidad | Velocidad amasadora | Medidas | U.Venta |
|-------|--------|------|-----------|-----------|---------------------|-----------------|---------|
| 69583 | 364,50 | 1000 | 5,0 L | 5 niveles | 130-540 rpm | 25x32,5x36,5 cm | 1 |

- Ruleta de velocidad integrada: 6 velocidades ajustables con función turbo y sistema de rotación planetaria.
- Mecanismo de engranajes metálicos.
- Bol de acero inoxidable de 6 L de máxima calidad.
- Tapa transparente anti salpicaduras con ventana.

- Integrated speed roulette: 6 adjustable speeds with turbo function and planetary rotation system.
- Metal gear mechanism.
- 6 L stainless steel bowl.
- Transparent anti splashes with window.



Batidora amasadora Complet

Batteur pétrisseur · Mix- und Knetmaschine
Mixer-kneader · Batedeira amassadora

| Ref | € | W | Capacidad | Velocidad | Velocidad amasadora | Medidas | U.Venta |
|-------|--------|------|-----------|-----------|---------------------|-----------------|---------|
| 69683 | 392,50 | 1500 | 6,0 L | 6 niveles | 117-606 rpm | 25,5x40x33,5 cm | 1 |

Household use



Semiprofessional use



Accesorios . Accessories

VIDRIO INOX
Glass

Accesorio jarra

Accessoire cruche · Krugzubehör
Jug accessory · Acessório de jarro



| Ref | € | U.Venta |
|-------|-------|---------|
| 69584 | 27,90 | 1 |
| 69684 | 27,90 | 1 |

INOX

Accesorio Picadora/embudidora/kibbe

Accessoire hachoir/stuffer/kibbe · Fleischwolf/Wurstfüller/Kibbe Zubehör
Chopper/stuffer/kibbe accessory · Acessório picador/stuffer /kibbe



| Ref | € | Cuchillas | U.Venta |
|-------|-------|-----------|---------|
| 69685 | 59,20 | 4 | 1 |

Batidos y cócteles

INOX    Professional use



- Batidora profesional.
 - Ideal para elaborar batidos y cócteles.
 - Con interruptor de velocidad y enganche para vaso batidor.
- Blender professionnel.
 - Idéal pour faire des milkshakes et des cocktails.
 - Avec un interrupteur de vitesse et un attelage pour fouetter du verre.
- Professional blender.
 - Ideal to make milkshakes and cocktails.
 - With speed switch and hitch for whipping glass.

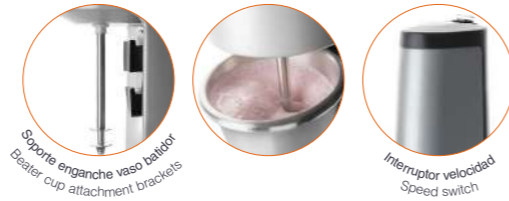

Batidora cóctel
Batteur · Mixer
Blender · Batedeira

| Ref | € | W | Capacidad | Velocidad | Medidas | U.Venta |
|-------|--------|-------|-----------|-------------------|-------------|---------|
| 69111 | 290,00 | 400 W | 0,6 L | 10000 - 15000 rpm | 21x15x51 cm | 1 |



Batidores de varillas

INOX     Household use

- Ideal para batir, mezclar y amasar fácilmente todo tipo de preparaciones reposteras de manera fácil y eficiente.
 - Potente, silencioso y ligero para una mayor comodidad durante el uso.
 - Empuñadura ergonómica; permite realizar la mezcla de manera segura y firme.
 - Incluye 2 varillas batidoras y 2 varillas amasadoras.
 - Extrae las varillas fácilmente con el botón de expulsión.
- Idéal pour battre, mélanger et pétrir toutes sortes de préparations de manière facile et efficace.
 - Puissant, silencieux et léger pour un plus grand confort lors d'une utilisation.
 - Poignée ergonomique; Il vous permet d'effectuer le mélange en toute sécurité et de partir.
 - Comprend 2 tiges de fouet et 2 tiges de pétrissage.
 - Extraire facilement les tiges avec le bouton d'expulsion.
- Ideal to beat, easily mix and knead all kinds of preparations in an easy and efficient way.
 - Powerful, silent and light for greater comfort during use.
 - Ergonomic handle; It allows you to perform the mixture safely and go.
 - Includes 2 whipping rods and 2 kneading rods.
 - Extract the rods easily with the expulsion button.



Batidora de varillas Home
Batteur à main · Handmixer
Hand mixer · Batedor de mão

| Ref | € | W | Velocidad | Medidas | U.Venta |
|-------|-------|-----|-----------|------------|---------|
| 69384 | 48,40 | 300 | 5 + TURBO | 18x8x14 cm | 1 |

Batidora de varillas TitanPro
Batteur à main · Handmixer
Hand mixer · Hand mixer

| Ref | € | W | Velocidad | Medidas | U.Venta |
|-------|-------|-----|-----------|----------------|---------|
| 69374 | 54,30 | 350 | 5 + TURBO | 14,5X8,5X19 cm | 1 |





Batidora Profesional Brisk



Professional use

- Fabricado en materiales altamente resistentes y de máxima calidad.
- El mango ergonómico ofrece mayor seguridad y control de la batidora.
- Indicado para trabajar en ollas de hasta 10 litros de capacidad.
- Los brazos trituradores, batidores y cuchillas, fabricados en acero inoxidable.
- Colocación y desmontaje sencillo e instantáneo, sin necesidad de utilizar herramientas.
- Prepara purés, cremas y todo tipo de salsas.

- Fabriqué dans des matériaux de qualité très résistants et maximaux.
- La mangue ergonomique offre une plus grande sécurité et contrôle du mélangeur.
- Indiqué pour fonctionner dans des pots pouvant atteindre 10 litres de capacité.
- Bras, baigneurs et lames écrasants, en acier inoxydable.
- Placement et démontage simple et instantané, sans utiliser d'outils.
- Préparez les purées, les crèmes et toutes sortes de sauces.

- Manufactured in highly resistant and maximum quality materials.
- The ergonomic mango offers greater security and control of the blender.
- Indicated to work in pots of up to 10 liters of capacity.
- Crushing arms, bathers and blades, made of stainless steel.
- Placement and simple and instant disassembly, without using tools.
- Prepare purees, creams and all kinds of sauces.

Botón de uso continuo
Continuous use button



Regulador de velocidad variable
Variable speed controller



Brazo de fácil desmontaje en acero inoxidable
Easy to remove arm made of stainless steel



Cuchilla de gran calidad para un óptimo trabajo
High-quality blade for optimum work

Serie 270



Batidor velocidad fija

Mixer vitesse fixe · Profi-mixer, Festréhzahl
Immersion blender fixed speed · Batedeira velocidade fixa

| Ref | € | W | Velocidad | Capacidad | U.Venta |
|-------|--------|-----|-----------|-----------|---------|
| 69722 | 237,10 | 270 | 20000 rpm | 10 L | 1 |



Batidor velocidad variable

Mixer vitesse variable · Profi-mixer, variable Geschwindigkeit
Immersion blender variable speed · Batedeira velocidade variável

| Ref | € | W | Velocidad | L | U.Venta |
|-------|--------|-----|------------------|------|---------|
| 69723 | 253,50 | 270 | 4000 - 20000 rpm | 10 L | 1 |



Brazo triturador

Pied mixeur · Rohr
Shaft tube · Pé triturador

| Ref | € | Largo (cm) | U.Venta |
|-------|--------|------------|---------|
| 69816 | 120,60 | 16 | 1 |



Set de llaves desmontaje cuchillas

Outil demontage lame set · Schüsselsatz zum Wechseln der Messer
Blade disassembly tool set · Set ferrament desmontagem lâmina

| Ref | € | U.Venta |
|---------|-------|---------|
| R69722J | 11,20 | 1 |



Brazo batidor

Fouet mélangeur · Rührbesen
Whisk · Pé amassadora

| Ref | € | Largo (cm) | U.Venta |
|-------|--------|------------|---------|
| 69815 | 168,50 | 18,5 | 1 |



Soporte batidora Brisk

Support mélangeur · Aufhängeleiste für Mixer
Blender stand · Suporte para batedeira

| Ref | € | Diámetro varilla (mm) | h(cm) | Largo (cm) | U.Venta |
|---------|-------|-----------------------|-------|------------|--------------|
| A 69801 | 9,00 | 5,0 | 5,5 | 7 | 1 Individual |
| B 69803 | 17,00 | 5,0 | 5,5 | 28 | 1 Triple |

Serie 350

Batidor velocidad fija



Batidor velocidad fija

Mixer vitesse fixe · Profi- mixer, Festdrehzahl
Immersion blender fixed speed · Batedeira velocidade fixa

| Ref | € | W | Velocidad (r.p.m.) | Capacidad | Medidas Brazo (cm) | Composición | U.Venta |
|----------------|---------------|-------|--------------------|-----------|--------------------|---------------|---------|
| A 69761 | 309,70 | 350 W | 16000 | 15 L | 20 | 69735 + 69820 | 1 |
| B 69762 | 322,80 | 350 W | 16000 | 20 L | 25 | 69735 + 69825 | 1 |
| C 69763 | 335,70 | 350 W | 16000 | 30 L | 30 | 69735 + 69830 | 1 |
| D 69764 | 355,10 | 350 W | 16000 | 80 L | 40 | 69735 + 69840 | 1 |
| E 69765 | 380,80 | 350 W | 16000 | 120 L | 50 | 69735 + 69850 | 1 |

Batidor velocidad variable

Regulador de velocidad variable
Variable speed controller



Batidor velocidad variable

Mixer vitesse fixe · Profi- mixer, Festdrehzahl
Immersion blender fixed speed · Batedeira velocidade fixa

| Ref | € | W | Velocidad (r.p.m.) | Capacidad | Medidas Brazo (cm) | Composición | U.Venta |
|----------------|---------------|-------|--------------------|-----------|--------------------|---------------|---------|
| A 69771 | 326,70 | 350 W | 4,000-16,000 | 15 L | 20 | 69736 + 69820 | 1 |
| B 69772 | 339,60 | 350 W | 4,000-16,000 | 20 L | 25 | 69736 + 69825 | 1 |
| C 69773 | 352,50 | 350 W | 4,000-16,000 | 30 L | 30 | 69736 + 69830 | 1 |
| D 69774 | 371,70 | 350 W | 4,000-16,000 | 80 L | 40 | 69736 + 69840 | 1 |
| E 69775 | 397,50 | 350 W | 4,000-16,000 | 120 L | 50 | 69736 + 69850 | 1 |

Serie 500

Batidor velocidad fija



Batidor velocidad fija

Mixer vitesse fixe · Profi- mixer, Festdrehzahl
Immersion blender fixed speed · Batedeira velocidade fixa

| Ref | € | W | Velocidad (r.p.m.) | Capacidad | Medidas Brazo (cm) | Composición | U.Venta |
|----------------|---------------|-------|--------------------|-----------|--------------------|---------------|---------|
| A 69781 | 327,40 | 500 W | 16,000 | 30 L | 20 | 69750 + 69820 | 1 |
| B 69782 | 340,40 | 500 W | 16,000 | 40 L | 25 | 69750 + 69825 | 1 |
| C 69783 | 353,30 | 500 W | 16,000 | 60 L | 30 | 69750 + 69830 | 1 |
| D 69784 | 372,50 | 500 W | 16,000 | 100 L | 40 | 69750 + 69840 | 1 |
| E 69785 | 398,30 | 500 W | 16,000 | 140 L | 50 | 69750 + 69850 | 1 |

Batidor velocidad variable

Regulador de velocidad variable
Variable speed controller



Batidor velocidad variable

Mixer vitesse fixe · Profi- mixer, Festdrehzahl
Immersion blender fixed speed · Batedeira velocidade fixa

| Ref | € | W | Velocidad (r.p.m.) | Capacidad | Medidas Brazo (cm) | Composición | U.Venta |
|----------------|---------------|-------|--------------------|-----------|--------------------|---------------|---------|
| A 69791 | 342,30 | 500 W | 4,000-16,000 | 30 L | 20 | 69751 + 69820 | 1 |
| B 69792 | 355,20 | 500 W | 4,000-16,000 | 40 L | 25 | 69751 + 69825 | 1 |
| C 69793 | 368,00 | 500 W | 4,000-16,000 | 60 L | 30 | 69751 + 69830 | 1 |
| D 69794 | 387,30 | 500 W | 4,000-16,000 | 100 L | 40 | 69751 + 69840 | 1 |
| E 69795 | 413,10 | 500 W | 4,000-16,000 | 140 L | 50 | 69751 + 69850 | 1 |

Accesorios



Motor batidor serie 350

Moteur mixer SÉRIE 350 · Mixer Motor, SERIE 350
Immersion blender motor, SERIE 350 · Motor bateadeira SÉRIE 350

| Ref | € | W | U.Venta |
|-------|--------|-----|--|
| 69735 | 174,60 | 350 | 1 Velocidad Fija · Fixed Speed |
| 69736 | 191,30 | 350 | 1 Velocidad Variable · Variable Speed |



Motor batidor serie 500

Moteur mixer SÉRIE 500 · Mixer Motor, SERIE 500
Immersion blender motor SERIE 500 · Motor bateadeira SÉRIE 500

| Ref | € | W | U.Venta |
|-------|--------|-----|--|
| 69750 | 192,00 | 500 | 1 Velocidad Fija · Fixed Speed |
| 69751 | 206,90 | 500 | 1 Velocidad Variable · Variable Speed |

Brazo triturador

Pied mixeur · Rohr
Shaft tube · Pé triturador

| Ref | € | Largo (cm) | A (cm) | U.Venta |
|----------------|--------|------------|--------|---------|
| A 69820 | 135,40 | 20 | 12,5 | 1 |
| B 69825 | 148,40 | 25 | 15,8 | 1 |
| C 69830 | 161,10 | 30 | 19,2 | 1 |
| D 69840 | 180,40 | 40 | 25,8 | 1 |
| E 69850 | 206,20 | 50 | 32,5 | 1 |
| F 69824 | 187,00 | 25 | - | 1 |

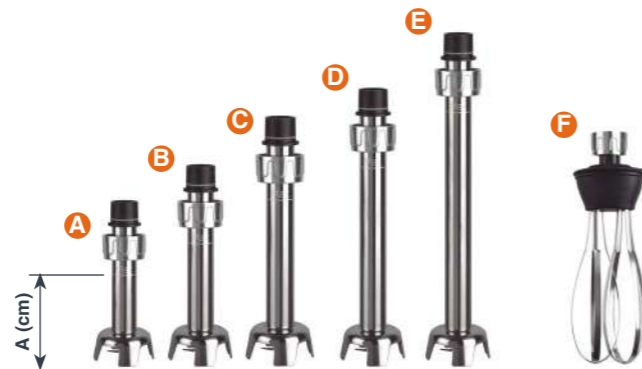

Set llaves desmontaje cuchillas

Outil démontage lame set · Schüsselsatz zum Wechseln der Messer
Blade disassembly tool set · Set ferrament desmontagem lâmina

| Ref | € | U.Venta |
|---------|-------|---------|
| R69735J | 11,20 | 1 |



Soporte batidora Brisk

Support mélangeur · Aufhängeleiste für Mixer
Blender stand · Suporte para bateadeira

| Ref | € | Diámetro varilla (mm) | h(cm) | Largo (cm) | U.Venta |
|----------------|-------|-----------------------|-------|------------|--------------|
| A 69801 | 9,00 | 5,0 | 5,5 | 7 | 1 Individual |
| B 69803 | 17,00 | 5,0 | 5,5 | 28 | 1 Triple |



Batidora profesional Rapid

new

INOX INOX 18/10 *Professional use*

- Batidora profesional con brazo triturador.
 - Fabricado en materiales altamente resistentes y de máxima calidad.
 - El mango ergonómico ofrece mayor seguridad y control de la batidora.
 - Indicado para trabajar en ollas de hasta 8 litros de capacidad.
 - El brazo triturador y cuchillas, fabricados en acero inoxidable.
 - Colocación y desmontaje del brazo sencillo e instantáneo, sin necesidad de utilizar herramientas.
 - Facilidad de limpieza.
 - Prepara purés (verduras, patatas, potajes, etc.), cremas (cebolla, pimientos, tomate, pastelería, etc.) y todo tipo de salsas.
- Mixeur professionnel avec bras de mixage.
 - Fabriqué avec des matériaux hautement résistants et d'une qualité maximale.
 - Le manche ergonomique offre une sécurité et un contrôle accru du mixeur.
 - Indiqué pour travailler dans des marmites de jusqu'à 8 litres de contenance.
 - Accessoires pour hacher e couper, fabriqués en acier inoxydable.
 - Installation et démontage des accessoires simple et instantané, sans utilisation d'outils supplémentaires.
 - Nettoyage facile.
 - Permet de préparer des purées (légumes, pommes de terre, soupes, etc.), des crèmes (oignons, poivrons, tomates, crème pâtissière, etc.) et tout type de sauces.
- Professional blender with blending arm.
 - Made from highly resistant materials of the highest quality.
 - The ergonomic handle provides greater safety and control of the blender.
 - Suitable for working in pots up to 8 litres.
 - The shredder, beater and blades are made of stainless steel.
 - Fitting and removing the arms is simple and instant, without using tools.
 - Easy to clean.
 - Prepare soups (vegetable, potato, broth, etc.), purées (onion, peppers, tomatoes, custard, etc.) and all kinds of sauces.

Serie 220



Batidor Rapid

Mixer Professional · Professionellen Stabmixer
Professional mixer · Bateadora Profissional

| Ref | € | W | Velocidad (r.p.m.) | Capacidad | U.Venta |
|-------|--------|-----|--------------------|-----------|---------|
| 69920 | 185,80 | 220 | 4000-18000 | 8 L | 1 |

Serie 228



Serie 280W

Serie 280W · 280W-Serie
280W Series · Série 280W

| Ref | € | W | Velocidad (r.p.m.) | Capacidad | Medidas Brazo (cm) | U.Venta |
|-------|--------|-----|--------------------|-----------|--------------------|---------|
| 69929 | 339,00 | 280 | 6000-20000 | 10L | 24 | 1 |

Serie 450

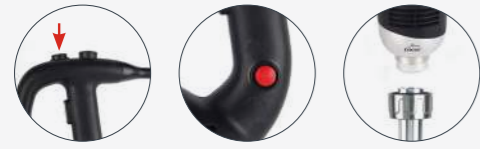

| Ref | € | W | Velocidad (r.p.m.) | Capacidad | Medidas Brazo (cm) | Composición | U.Venta |
|----------------|---------------|-----|--------------------|-----------|--------------------|---------------|---------|
| A 69905 | 438,40 | 450 | 4000-16000 | 30 L | 25 | 69946 + 69925 | 1 |
| B 69906 | 447,40 | 450 | 4000-16000 | 50 L | 30 | 69946 + 69930 | 1 |
| C 69907 | 465,60 | 450 | 4000-16000 | 100 L | 40 | 69946 + 69940 | 1 |

Serie 650

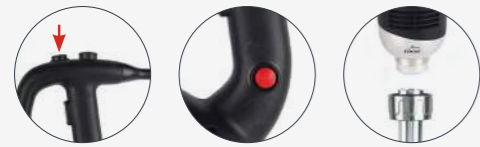

| Ref | € | W | Velocidad (r.p.m.) | Capacidad | Medidas Brazo (cm) | Composición | U.Venta |
|----------------|---------------|-----|--------------------|-----------|--------------------|---------------|---------|
| A 69932 | 478,20 | 650 | 8000-18000 | 80 L | 30 | 69966 + 66930 | 1 |
| B 69933 | 496,40 | 650 | 8000-18000 | 140 L | 40 | 69966 + 69940 | 1 |
| C 69934 | 514,60 | 650 | 8000-18000 | 180 L | 50 | 69966 + 69950 | 1 |
| D 69935 | 523,90 | 650 | 8000-18000 | 220 L | 55 | 69966 + 69955 | 1 |

Serie 850

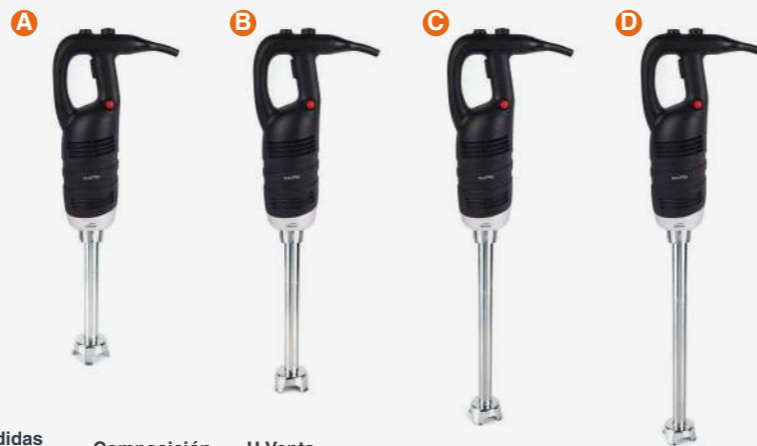

| Ref | € | W | Velocidad (r.p.m.) | Capacidad | Medidas Brazo (cm) | Composición | U.Venta |
|----------------|---------------|-----|--------------------|-----------|--------------------|---------------|---------|
| A 69976 | 509,00 | 850 | 8000-18000 | 100 L | 30 | 69986 + 69930 | 1 |
| B 69977 | 527,20 | 850 | 8000-18000 | 160 L | 40 | 69986 + 69940 | 1 |
| C 69978 | 545,40 | 850 | 8000-18000 | 200 L | 50 | 69986 + 69950 | 1 |
| D 69979 | 554,70 | 850 | 8000-18000 | 240 L | 55 | 69986 + 69955 | 1 |

Accesorios



Motor batidor Rapid

Mixer Professional - Profi-Mixer
Professional mixer - Batedora Profissional

| Ref | € | W | Velocidad (r.p.m.) | U.Venta |
|----------------|---------------|-----|--------------------|---------|
| A 69946 | 256,80 | 450 | 4000-16000 | 1 |
| B 69966 | 287,60 | 650 | 8000-18000 | 1 |
| C 69986 | 318,50 | 850 | 8000-18000 | 1 |

INOX 18/10

Brazo triturador Rapid

Pied mixeur - Rohr
Shaft tube - Pé triturador

| Ref | € | h(cm) | A (cm) | U.Venta |
|----------------|---------------|-------|--------|---------|
| A 69916 | 152,00 | 24 | 15 | 1 |
| B 69925 | 181,50 | 25 | 17 | 1 |
| C 69930 | 190,60 | 30 | 20 | 1 |
| D 69940 | 208,70 | 40 | 27 | 1 |
| E 69950 | 226,90 | 50 | 35 | 1 |
| F 69955 | 236,30 | 55 | 38 | 1 |
| F 69918 | 195,10 | 18,5 | - | 1 |
| G 69926 | 192,80 | 25 | - | 1 |



Bamix

INOX
18/10



Professional use

- Permite montar, batir, mezclar, triturar y picar todo tipo de frutas y verduras, así como picar hielo, gracias a sus cuchillas.
- Batidora de precisión y alta calidad.
- Permite trabajar con ella largo tiempo sin que se caliente.
- Mango diseñado para adaptarse a la mano.
- 2 posiciones: I : se utiliza con cantidades pequeñas, para preparados ligeros y esponjosos. II : se usa para cantidades más grandes e ingredientes viscosos y consistentes.

- Il permet d'assembler, de battre, de mélanger, d'écraser et de hacher toutes sortes de fruits et légumes, ainsi que de hacher de la glace, grâce à leurs lames.
- Blender de précision et de haute qualité.
- Vous permet de travailler avec elle pendant longtemps sans chaud.
- Mango conçu pour s'adapter à la main.
- 2 positions: I: Il est utilisé avec de petites quantités, pour des préparations légères et duveteées. II: Il est utilisé pour des quantités plus importantes et des ingrédients visqueux et cohérents.

- It allows to assemble, beat, mix, crush and chop all kinds of fruits and vegetables, as well as chop ice, thanks to their blades.
- Precision and high quality blender.
- Allows you to work with her for a long time without hot.
- Mango designed to adapt to hand.
- 2 Positions: I: It is used with small amounts, for light and fluffy preparations. II: It is used for larger amounts and viscous and consistent ingredients.



Cuchilla para carne

lame à viande · Klinge für Fleisch
Blade for meat · Lâminar para carne

| Ref | € | U.Venta |
|---------|-------|---------|
| R61672D | 20,70 | 1 |



Set pulverizador

Broyeur · Mahleinheit
Pulverizing unit · Conjunto pulverizador

| Ref | € | ml | U.Venta |
|-------|-------|-----|---------|
| 61674 | 48,60 | 250 | 1 |



Set cortador

Combiné râpeur · Schneide-/Zubereitungseinheit
Cutting/preparing unit · Conjunto cortador

| Ref | € | ml | U.Venta |
|-------|--------|-----|---------|
| 61675 | 199,50 | 500 | 1 |



Batidora Bamix

Mixer · Mixer
Mixer · Batedeira

| Ref | € | W | h (cm) | Velocidad | Inmersión | U.Venta |
|-------|--------|-------|--------|-----------------|-----------|---------|
| 61672 | 339,40 | 200 W | 39,5 | 14000-18000 rpm | 25 cm | 1 |
| 61673 | 530,20 | 350 W | 49,5 | 18000-22000 rpm | 35 cm | 1 |



Provite

new

INOX



Professional use

- Batidora de precisión y de alta calidad. Potente y eficaz.
- Resultados extraordinarios: cortar, picar, triturar, mezclar, batir, montar o emulsionar cualquier preparación.
- Mango ergonómico, permite una sujeción perfecta y garantiza un fácil manejo.
- Incluye tres cuchillas intercambiables de acero inoxidable de máxima calidad, un soporte y llave para cambiar las cuchillas.
- Sistema anti-salpicaduras.
- Pie batidor fabricado en acero inoxidable de gran calidad.

- Mixeur de précision et de grande qualité. Puissant et efficace.
- Résultats extraordinaires : couper, hacher, mixer, mélanger, battre ou émulsionner tout type de préparations.
- Manche ergonomique qui permet une prise en main parfaite et garantit une manipulation aisée.
- Inclut trois lames interchangeables en acier inoxydable de la plus grande qualité, un support et une clé pour les changer.
- Système anti-éclaboussures.
- Pied fabriqué en acier inoxydable de grande qualité.
- Nettoyage facile. Il est important que la partie supérieure où se trouve le moteur ne soit pas en contact direct avec de l'eau.

- Top-quality, high-precision hand blender. Powerful and efficient.
- Exceptional results: ideal for cutting, chopping, grinding, mixing, beating, whipping or emulsifying mixtures of any kind.
- Ergonomic handle for a perfect grip and easy handling.
- Includes three high-quality stainless steel interchangeable blades, a support and a tool to change them.
- Anti-splash system.
- High-quality stainless steel blender arm.
- Easy to clean.
- Warning: the upper part where the motor is located must not come into direct contact with water.

Provite

Mixer · Mixer
Mixer · Batedeira

| Ref | € | W | Velocidad (r.p.m.) | Ø (cm) | h (cm) | U.Venta |
|-------|--------|-----|--------------------|--------|--------|---------|
| 61664 | 150,80 | 170 | 22000 | 6,3 | 34 | 1 |



Batidora Fast

INOX 18/10 BPA free Dishwasher DC CE Household use



Cuchillas exclusivas de alto rendimiento
Exclusive high performance blades

Batidora Fast
Mixeur · Mixer
Blender · Batedeira

| Ref | € | W | Velocidad | Capacidad vaso | Medidas | U.Venta |
|---------|-------|-----|----------------|----------------|-----------------------|---------|
| A 61681 | 77,00 | 700 | 9000-16000 rpm | 500 | 14,5 x 14,5 x 40,5 cm | 1 |
| B 61671 | 87,90 | 700 | 9000-16000 rpm | 500 | 14,5 x 14,5 x 40,5 cm | 1 |

Premium

BPA free Dishwasher AC CE Household use



Botón de bloqueo
Regulador de velocidad
Lock button
Speed regulator button



Cuchillas afiladas
Antisalpicaduras
Sharp blades
Anti-splash housing

Batidora Premium
Mixer · Mixer
Mixer · Batedeira

| Ref | € | W | Velocidad | Capacidad vaso | Medidas | U.Venta |
|-------|-------|------|-----------|----------------|---------------|---------|
| 61678 | 65,40 | 1000 | 16000 rpm | 800 ml | 5,5x6,5x41 cm | 1 |



Picadora Fast
Hachoir · Fleischwolf
Mincer · Picadora

| Ref | € | ml | U.Venta |
|---------|-------|-----|---------|
| R61671A | 12,60 | 750 | 1 |



Batidor varillas Premium
Fouet multibrins · Schneebesens
Wire whisk · Batedeira varetas

| Ref | € | Largo (cm) | U.Venta |
|---------|------|------------|---------|
| R61678L | 5,70 | 23 | 1 |



Picadora Premium
Hachoir · Fleischwolf
Mincer · Picadora

| Ref | € | ml | U.Venta |
|---------|-------|-----|---------|
| R61678K | 11,10 | 500 | 1 |

Pro

INOX 18/10 BPA free Dishwasher DC CE Household use



Batidora Pro
Mixer · Mixer
Mixer · Batedeira

| Ref | € | W | Velocidad | Capacidad vaso | Medidas | U.Venta |
|---------|-------|------|-----------------|----------------|---------------|---------|
| A 61682 | 70,60 | 1000 | 13000-16000 rpm | 800 ml | 41x6,5x6,5 cm | 1 |
| B 61683 | 78,90 | 1000 | 13000-16000 rpm | 800 ml | 41x6,5x6,5 cm | 1 |



Batidor varillas Pro
Fouet multibrins · Schneebesens
Wire whisk · Batedeira varetas

| Ref | € | Largo (cm) | U.Venta |
|---------|------|------------|---------|
| R61682B | 7,50 | 20 | 1 |



Picadora
Hachoir · Fleischwolf
Mincer · Picadora

| Ref | € | ml | U.Venta |
|---------|-------|-----|---------|
| R61682A | 12,90 | 500 | 1 |

Mix

INOX 18/10 BPA free Dishwasher DC CE Household use



Regulador de velocidad
Speed regulator



Cuchillas afiladas
Sharp blades

Batidora Mix
Mixer · Mixer
Mixer · Batedeira

| Ref | € | W | Velocidad | Capacidad vaso | Medidas | U.Venta |
|-------|-------|------|-------------------|----------------|---------------|---------|
| 61679 | 62,60 | 1200 | 13000 - 15300 rpm | 800 ml | 41x6,5x6,5 cm | 1 |



Picadora Mix
Hachoir · Fleischwolf
Mincer · Picadora

| Ref | € | ml | U.Venta |
|----------|-------|-----|---------|
| R61679AA | 12,40 | 800 | 1 |



Batidor Varillas Mix
Fouet multibrins · Schneebesens
Wire whisk · Batedeira varetas

| Ref | € | Largo (cm) | U.Venta |
|----------|------|------------|---------|
| R61679AB | 7,00 | 23 | 1 |



TitanPro



Household use



Picadora incluida
Mincer included

Batidora TitanPro
Mixer · Mixer
Mixer · Batedeira

| Ref | € | W | Velocidad | Capacidad vaso | Picadora | Medidas | U.Venta |
|---------|-------|-----|-----------|----------------|----------|-----------------|---------|
| A 61668 | 47,70 | 600 | 15000 rpm | 600 ml | - | 8,5x6,3x39,5 cm | 1 |
| B 61669 | 60,80 | 600 | 15000 rpm | 600 ml | 500 ml | 8,5x6,3x39,5 cm | 1 |



Picadora TitanPro
Hachoir · Fleischwolf
Mincer · Picadora

| Ref | € | ml | U.Venta |
|---------|-------|-----|---------|
| R61668C | 17,50 | 500 | 1 |



Batidora varillas TitanPro
Fouet multibrins · Schneebesen
Wire whisk · Batedeira varetas

| Ref | € | Largo (cm) | U.Venta |
|---------|------|------------|---------|
| R61668D | 8,70 | 23,5 | 1 |

Picadora Quick



Professional use



Picadora Quick
Hachoir professionnel · Professioneller Zerkleinerer
Professional chopper · Picadora profesional

| Ref | € | W | Velocidad | L | Medidas | U.Venta |
|-------|---------|-----|-----------|---|---------------|---------|
| 69490 | 1007,60 | 735 | 1500 rpm | 3 | 28,5x32x43 cm | 1 |

- Picadora profesional que pica y tritura todo tipo de alimentos (verduras, hortalizas, carnes y frutos secos, etc.) de manera rápida y homogénea.
- Contenedor extraíble de acero inoxidable 18/10 de máxima calidad de 3 litros de capacidad.
- Tapa de trítan transparente totalmente extraíble con orificio para añadir ingredientes en marcha. Libre de BPA.
- Cuchillas extraíbles de acero inoxidable totalmente afiladas.
- 100% seguro: evita la puesta en marcha si el contenedor o la tapa no están en la posición adecuada.
- Motor de 735W de potencia y velocidad de 1500 rpm.
- Dispone de protección contra el sobrecalentamiento.
- Encendido y apagado con un solo clic mediante el botón ON / OFF.
- Cubeta inclinada para una fácil introducción y recogida de los alimentos.
- Pies antideslizantes para una máxima estabilidad.
- Fácil limpieza. Contenedor y tapa aptos para el lavavajillas.

- Professional chopper that itch and crush all kinds of food (vegetables, vegetables, meats and nuts, etc.) quickly and homogeneously.
- Removable stainless steel container 18/10 of maximum quality of 3 liters of capacity.
- Transparent Tritan Cover totally removable with hole to add in progress. BPA free.
- Removable stainless steel blades fully sharp.
- 100% Sure: Avoid implementing whether the container or lid are not in the right position.
- 735W engine of power and speed of 1500 rpm.
- It has protection against overheating.
- Light and off with a single click using the ON / OFF button.
- Inclined bucket for easy introduction and collection of food.
- Non -slip feet for maximum stability.
- Easy cleaning. Container and cover suitable for dishwasher.

Picadora Quartz



Household use



Picadora Quartz
Hachoir en verre · Fleischwolf, glas
Glass mincer · Picadora de vidro

| Ref | € | W | L | Cuchillas | Medidas | U.Venta |
|-------|-------|-----|-----|-----------|---------------|---------|
| 69077 | 46,60 | 300 | 1,2 | 4 | 19x16x25 cm | 1 |
| 69073 | 71,70 | 300 | 2,0 | 4 | 21x17,5x27 cm | 1 |

- Picadora eléctrica compacta que pica todo tipo de alimentos, como verduras, frutas, jengibre, ajo, cebolla, frutos secos y hierbas.
- Cabezal de acero inoxidable y recipiente de cristal de alta calidad.
- Cuchillas ultrarresistentes.
- Gracias a los engranajes metálicos permite un uso continuo.
- Corta con precisión y homogéneamente.
- 2 velocidades; la más veloz para un corte rápido y la más lenta para un corte más controlado.
- Base antideslizante para facilitar la tarea y evitar desplazamientos.
- Fácil de desmontar y limpiar. Contenedor y cuchillas aptos para el lavavajillas.

- Compact electric chopper that itch all kinds of food, such as vegetables, fruits, ginger, garlic, onion, nuts and herbs.
- Stainless steel head and high quality glass container.
- Ultra -resistant blades.
- Thanks to metal gears allows continuous use.
- Cut precisely and homogeneously.
- 2 speeds; The fastest for a quick and slower cut for a more controlled cut.
- Non -slip base to facilitate task and avoid displacements.
- Easy to disassemble and clean. Container and blades suitable for dishwasher.



Picadoras de carne



Semiprofessional use

- Picadoras estables y resistentes.
- Engranajes interiores y exteriores metálicos para una mayor resistencia.
- Incluyen 3 discos perforados de acero inoxidable.
- Incluyen 4 accesorios extra (Kibbe incluido).
- Totalmente desmontables para facilitar su limpieza.

- Hachoirs stables et résistants.
- Engrainages intérieurs et extérieurs métalliques pour une plus grande résistance.
- Inclut 3 disques perforés en acier inoxydable.
- Inclut 4 accessoires supplémentaires (kebbeh inclus).
- Totalemt démontable pour faciliter son nettoyage.

- Stable and resistant choppers.
- Interior and exterior metal gear teeth for improved resistance.
- Includes 3 stainless steel perforated discs.
- Includes 4 extra accessories (Kibbe included).
- Can be fully disassembled for easy cleaning

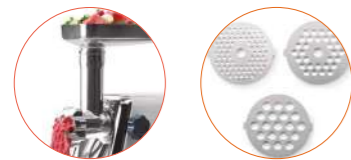

3 discos perforados
3 stainless steel perforated discs



Embutidos (salchichas, chorizo...)
Sausages (salchicha, chorizo...)



Kibbe
kibbe



Productividad
2 kg/min
Productivity



Picadora de carne Pro

Hachoir pour viande · Fleischwolf
Meat mincer · Picadora de carne

| Ref | € | W | Par motor | Velocidad | Capacidad | Medidas | U.Venta |
|-------|--------|-----|-----------|-----------|-----------|---------------|---------|
| 69368 | 612,60 | 550 | 1,27 Nm | 240 rpm | 2kg/min | 53,5x26x35 cm | 1 |



Productividad
1 kg/min
Productivity



Productividad
1 kg/min
Productivity

Picadora de carne Strong

Hachoir pour viande · Fleischwolf
Meat mincer · Picadora de carne

| Ref | € | W | Par motor | Capacidad | Medidas | U. Venta |
|-------|--------|-----|-----------|-----------|-------------|----------|
| 69068 | 240,40 | 800 | 0,25 Nm | 1 Kg/min | 35x18x36 cm | 1 |

Picadora de carne Chop

Hachoir pour viande · Fleischwolf
Meat mincer · Picadora de carne

| Ref | € | W | Par motor | Capacidad | Medidas | U.Venta |
|-------|--------|-----|-----------|-----------|-------------|---------|
| 69369 | 120,50 | 300 | 0,14 Nm | 1 Kg/min | 43x17x36 cm | 1 |

Cortadoras Fiambre



- Cortadora eléctrica de alto rendimiento.
- Corta sin esfuerzo y con una gran precisión.
- Cuchilla desmontable de acero inoxidable de gran calidad.
- Regulador de grosor de corte entre 0 y 11/13 mm.
- Estructura de aluminio, transmisión por correa, pantalla protectora y cabezal ajustable de suave deslizamiento.
- Cuenta con un alador extraíble para ayudar al mantenimiento de la cuchilla.

- Cutter électrique haute performance.
- Coupez sans effort et avec une grande précision.
- Lame amovible en acier inoxydable détachable.
- Coupez un régulateur épais entre 0 et 11/13 mm.
- Structure en aluminium, transmission de la courroie, écran de protection et tête réglable de glissement doux.
- Il a un aor amovible pour aider à la maintenance de la lame.

- High performance electric cutter.
- Cut effortlessly and with great precision.
- Detachable stainless steel removable blade.
- Cut thick regulator between 0 and 11/13 mm.
- Aluminum structure, belt transmission, protective screen and adjustable head of soft slip.
- It has a removable aor to help maintenance of the blade.

Professional use



Household use



Cortadora de fiambre Profesional
Trancheuse de charcuterie · Aufschnittmaschine
Cold meat cutter · Cortadora de fiambre

| Ref | € | W | Cuchilla (cm) | Espesor corte | Medidas | U.Venta |
|-------|---------|-----|---------------|---------------|-------------|---------|
| 69125 | 678,30 | 150 | Ø 25 | 0-11 mm | 49x39x36 cm | 1 |
| 69130 | 1158,80 | 250 | Ø 30 | 0 - 13 mm | 60x58x44 cm | 1 |



Cortadora de fiambre Home
Trancheuse de charcuterie · Aufschnittmaschine
Cold meat cutter · Cortadora de fiambre

| Ref | € | W | Cuchilla (cm) | Espesor corte | Medidas | U.Venta |
|-------|--------|-----|---------------|---------------|-----------------|---------|
| 69118 | 121,30 | 150 | Ø 19 | 0 - 15 mm | 37,5x28x27,5 cm | 1 |

Cortador de Kebab



Household use



- Potente, silencioso e higiénico.
- Cuchilla desmontable de acero inoxidable de gran calidad.
- Corta sin esfuerzo y con gran precisión.
- Regulador del grosor de corte (Ajustable de 0 a 8 mm).
- Mango ergonómico, se adapta perfectamente a la mano.
- Incluye un destornillador para desmontar la cuchilla y una práctica piedra afiladora.

- Puissant, silencieux et hygiénique.
- Lame amovible en acier inoxydable détachable.
- Coupez sans effort et avec une grande précision.
- Régulateur d'épaisseur de coupe (réglable de 0 à 8 mm).
- Mango ergonomique, s'adapte parfaitement à la main.
- Comprend un tournevis pour démonter la lame et un affûteur de pratique.

- Powerful, silent and hygienic.
- Detachable stainless steel removable blade.
- Cut effortlessly and with great precision.
- Cutting thickness regulator (adjustable from 0 to 8 mm).
- Ergonomic mango, adapts perfectly to hand.
- Includes a screwdriver to disassemble the blade and a practice sharpener.

Cortador de Kebab

Couteau à kebab · Kebab-Schneider
Kebab cutter · Cortador de kebab

| Ref | € | W | Velocidad | Cuchilla (cm) | Espesor corte | Medidas | U.Venta |
|-------|--------|----|-----------|---------------|---------------|-----------------|---------|
| 69230 | 200,10 | 80 | 2800 rpm | Ø 10 | 0 - 8 mm | 20x11,5x18,5 cm | 1 |

Cortador de vegetales Profesional

AL INOX    Professional use



- Cortador de verduras para uso profesional.
 - Construida totalmente en aluminio anodizado de alta resistencia.
 - Cuerpo superior abatible para facilitar la limpieza, el mantenimiento y la colocación de los discos de corte.
 - 2 entradas para los diferentes tipos de verduras; entrada semicircular con palanca para alimentos voluminosos (patatas, tomates, cebollas, etc.) y entrada redonda con empujador para verduras y hortalizas más pequeñas (pepinos, calabacín, zanahorias, etc.).
 - Incluye 5 cuchillas: dos discos de corte (2 y 4 mm) y tres discos para rallar (3, 5 y 7 mm).
 - Funcionamiento continuo. Transmisión por correa.
 - 2 sistemas de seguridad: tornillo de bloqueo de tapa y un sensor electromagnético (al abrir la tapa se apaga la máquina).
 - 4 patas de goma para una mejor estabilidad.
- Vegetable cutter for professional use.
 - Built completely in high -strength anodized aluminum.
 - Folding upper body to facilitate cleaning, maintenance and placement of cutting discs.
 - 2 entries for different types of vegetables; Semicircular input with bulky food lever (potatoes, tomatoes, onions, etc.) and round entrance with smaller vegetables and vegetables (cucumbers, zucchini, carrots, etc.).
 - Includes 5 blades: two cutting discs (2 and 4 mm) and three albums to grate (3, 5 and 7 mm).
 - Continuous operation. Correa transmission.
 - 2 safety systems: cover lock screw and an electromagnetic sensor (when opening the lid the machine is turned off).
 - 4 rubber legs for better stability.

Cortador de vegetales Profesional

Disque de coupe · Schneidscheibe
Cutter disc · Disco de corte

| Ref | € | W | Velocidad | Medidas | U.Venta |
|-------|---------|-----|------------|-------------|---------|
| 69500 | 1424,20 | 550 | 270 r.p.m, | 57x23x51 cm | 1 |



Accesorios



Disco rallador

Disque de coupe · Schneidscheibe
Cutter disc · Disco de corte

| Ref | € | mm | U.Venta |
|----------------|-------|----|---------|
| A 69503 | 47,50 | 3 | 1 |
| B 69505 | 47,50 | 5 | 1 |
| C 69507 | 47,50 | 7 | 1 |

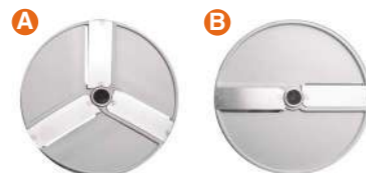

Disco cortador

Disque de coupe · Schneidscheibe
Cutter disc · Disco de corte

| Ref | € | mm | U.Venta |
|----------------|-------|----|---------|
| A 69512 | 47,50 | 2 | 1 |
| B 69514 | 47,50 | 4 | 1 |

Disco cortador (no incluido)

Disque de coupe · Schneidscheibe
Cutter disc · Disco de corte

| Ref | € | mm | U.Venta |
|----------------|--------|-------|---------|
| A 69518 | 94,70 | 8 | 1 |
| B 69510 | 94,70 | 10 | 1 |
| C 69504 | 110,00 | 10 | 1 |
| D 69506 | 128,70 | 10x10 | 1 |



Procesador de alimentos MultiGenius

INOX 18/10     Household use



- Múltiples funciones: pica, ralla, mezcla, bate, monta y tritura.
- Rendimiento óptimo y profesional: resultados rápidos, homogéneos e inmejorables.
- Gran capacidad; recipiente transparente graduado y jarra batidora transparente graduada.
- Infinidad de posibilidades: gracias a sus accesorios de alto rendimiento podrás cocinar sin esfuerzo.
- Tapa y bol con sistema de anclaje de seguridad.
- Diseño atractivo, compacto y muy cómodo para guardar: los accesorios pueden guardarse en el mismo recipiente.

- Multiple functions: Pica, Ralla, Mix, bat, riding and crushing.
- Optimal and professional performance: rapid, homogeneous and unbeatable results.
- Great capacity; Transparent graduate container and graduated transparent blender jug.
- Ifinity of possibilities: Thanks to its high performance accessories you can cook effortlessly.
- Cover and bowl with safety anchor system.
- Attractive, compact and very comfortable design to save: accessories can be stored in the same container.



- Corte con cuchilla**
Cutting with blades
- Exprimidor**
Citrus press
- Conjunto Cuchillas**
Mezclador-amasa-
dor Batidor
Set Blades
Mixer-kneader · Whisk
- Jarra batidora**
Blender jug

Procesador de alimentos MultiGenius

Robot multifonction · Küchenmaschine
Food processor · Processador de alimentos

| Ref | € | W | Velocidad | Capacidad vaso | U.Venta |
|-------|--------|-----|-----------|---------------------------------|---------|
| 69579 | 135,60 | 800 | 2+PULSE | 2L (jarra), 1,5L (jarra batido) | 1 |

Robot multifunción

INOX 18/10     Household use



- Jarra batidora**
Blender jug
- Conjunto batidor/montador**
Blending/whipping unit
- Molinillo + Tapa**
Grinder + Lid
- Discos corte**
Cutting discs



- Conj. exprimidor**
Juicer attachment
- Cortador mini**
Mini cutter
- Conj. licuadora**
Smoothie unit
- Corte con cuchilla**
Cutting with blades

Robot multifunción

Robot multifonctions · Multifunktions-Roboter
Multifunction robot · Robò multifuncionais

| Ref | € | W | Velocidad | Capacidad vaso | U.Venta |
|-------|--------|-----|-----------|----------------|---------|
| 69079 | 189,30 | 800 | 10 | 1,5 L | 1 |

Corta vegetales + Máquina de helado Cosmo

INOX 18/10 BPA free AC CE Household use



- Versátil: procesador eléctrico de verduras con accesorio para hacer helado.
- Incluye 6 cuchillas de corte (en formato cono) de acero inoxidable de máxima calidad para todo tipo de cortes; verdura, fruta, queso, frutos secos, chocolate, etc.
- Incluye un accesorio diseñado para hacer helados y sorbetes con fruta congelada.
- Rápido, intuitivo y muy fácil de usar.
- Compacto: práctico para usar y guardar; las cuchillas se almacenan en el interior.
- 100% seguro: no hay contacto directo con las manos.
- Funcionamiento silencioso.

- Versatile: Electric vegetable processor with accessory to ice cream.
- Includes 6 cutting blades (in cone format) of maximum stainless steel for all types of cuts; vegetables, fruit, cheese, nuts, chocolate, etc.
- Includes an accessory designed to make ice cream and sorbets with frozen fruit.
- Fast, intuitive and very easy to use.
- Compact: practical to use and save; The blades are stored inside.
- 100% Insurance: There is no direct contact with the hands.
- Silent functioning.

Corta vegetales + Máquina de helado Cosmo

Hachoir légumes + machine à fruitcreme glacee · Gemüseschneider + Obst-Eis machine
Vegetables cutter + ice fruit machine · Corta vegetables + máq. de gelado de fruta

| Ref | € | W | Cuchillas | Medidas | U.Venta |
|-------|-------|-----|-----------|-------------------|---------|
| 69115 | 82,50 | 150 | 6 | 24,5x22,5x19,5 cm | 1 |

Cocedor de vapor Ecco

PS Plastic BPA free CE Household use



- Vaporera multifunción para cocinar al vapor todo tipo de verduras, pescados, arroces, huevos, etc.
- Gracias a la cocción a baja temperatura, los alimentos mantienen las vitaminas, las sales minerales y la textura de los alimentos.
- 3 recipientes: Diseñado para preparar varios alimentos simultáneamente manteniendo todos los sabores, aromas y nutrientes.
- Contenedor especial para cocinar arroz.
- Capacidad: 12L.
- 100% Libre de BPA.

- Cuit-vapeur multifonction pour cuire à la vapeur toutes sortes de légumes, poissons, riz, œufs, etc.
- Grâce à la cuisson à basse température, les aliments conservent leurs vitamines, leurs sels minéraux et leur texture.
- 3 récipients : Conçus pour préparer plusieurs aliments simultanément en conservant toutes les saveurs, les arômes et les nutriments.
- Récipient spécial pour la cuisson du riz.
- Capacité : 12L.
- 100% sans BPA.

- Multifunction steamer for steaming all kinds of vegetables, fish, rice, eggs, etc.
- Thanks to low-temperature cooking, the food retains its vitamins, mineral salts and texture.
- 3 containers: Designed to prepare several foods simultaneously while maintaining all the flavours, aromas and nutrients.
- Special container for cooking rice.
- Capacity: 12L.
- 100% BPA free.

Cocedor de vapor Ecco

Cuiseur vapeur · Dampkochgerät
Steam cooker · Panela de cocção a vapor

| Ref | € | W | Rango temperatura | Capacidad | Medidas | U.Venta |
|-------|-------|------|-------------------|-----------|-------------|---------|
| 69121 | 94,50 | 1000 | Hasta 100 °C | 12L | 41x35x26 cm | 1 |

Deshidratadores

BPA free CE Household use

- Deshidratador de alimentos profesional fabricado en acero inoxidable de.
- Doble pared lateral que retiene el calor y garantiza su rendimiento térmico.
- Motor-ventilador y sistema de circulación de aire caliente de 360°.
- Puerta de vidrio transparente para controlar el proceso de deshidratación.
- Gran capacidad: Incluye 14 bandejas extraíbles fabricadas en acero inoxidable 18/10.
- Temporizador programable hasta 24h y temperatura ajustable entre 35°-75°.

- Professional food dehydrator made of high quality stainless steel.
- Double side walls retain heat and guarantee thermal performance.
- Fan-motor and 360° hot air circulation system.
- Transparent glass door for monitoring the dehydration process.
- Large capacity: Includes 14 removable trays made of 18/10 stainless steel.
- Programmable timer up to 24h and adjustable temperature between 35°-75°.

INOX 18/10

Deshidratador de alimentos Dry

Deshydrateur des aliments · Obsttrockner, elektrisch
Food dehydrator · Desidratador de alimentos

| Ref | € | W | Rango temperatura | Capacidad | Medidas | U.Venta |
|-------|--------|------|-------------------|--------------------|-------------|---------|
| 69524 | 567,90 | 1000 | 35-75°C | 14 bandejas/ trays | 47x44x59 cm | 1 |



Household use



PS Plastic

Deshidratador giratorio Terra

Déshydrateur tournant · Drehdehydrator
Rotating dehydrator · Desidratador giratório

| Ref | € | W | Rango temperatura | Capacidad | Medidas | U.Venta |
|-------|--------|-----|-------------------|-------------------|-----------|---------|
| 69223 | 133,00 | 500 | 70°C (max) | 5 bandejas/ trays | Ø33x22 cm | 1 |

Professional use



PS Plastic

Deshidratador de alimentos Pro

Deshydrateur des aliments · Obsttrockner, elektrisch
Food dehydrator · Desidratador de alimentos

| Ref | € | W | Rango temperatura | Capacidad | Medidas | U.Venta |
|-------|--------|-----|-------------------|-------------|-------------|---------|
| 69523 | 209,50 | 800 | 29°C - 73°C | 6 Bandejas/ | 47x36x26 cm | 1 |

Household use



PS Plastic

Deshidratador de alimentos White

Déshydrateur des aliments · Obsttrockner, elektrisch
Food dehydrator · Desidratador de alimentos

| Ref | € | W | Rango temperatura | Capacidad | Medidas | U.Venta |
|-------|-------|-----|-------------------|-------------------|-------------|---------|
| 69123 | 78,40 | 250 | 70°C (max) | 5 bandejas /trays | Ø33 x 27 cm | 1 |

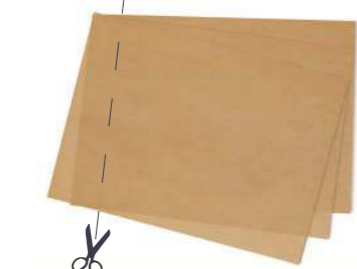

Fácil de cortar
Easy to cut

Fibra de vidrio 250°C Max Fiberglass Oven Microwave Dishwasher ECO 770A Max

Láminas antiadherentes

Feuilles antiadhésif · Antihaf-Blätter
Non-stick sheets · Lâminas antiaderentes

| Ref | € | cm | Unidad | U.Venta |
|-------|-------|-------|--------|---------|
| 66746 | 10,10 | 30x40 | 3 | 1 |

Freidora de inducción

INOX CE  Professional use

- Ideal para un uso intensivo en la hostelería y cocinas con grandes cargas de trabajo.
- Potente y eficiente. Capacidad de 8 L.
- Construida totalmente en acero inoxidable (exterior e interior) que garantiza durabilidad y resistencia.
- Gracias al sistema de calentamiento por inducción se consigue una temperatura estable en todo el área, disminuyendo el impacto térmico en el momento de introducir los alimentos.
- Control de temperatura variable de 60°C a 190°C.
- Protección contra el sobrecalentamiento.
- Equipada con grifo de vaciado y elemento de calentamiento oculto para facilitar la limpieza.
- Tapa y cesta incluidas

- Idéal pour une utilisation intensive dans l'hospitalité et les cuisines avec de grandes charges de travail.
- Puissant et efficace. 8 L's Capacité.
- Construit totalement en acier inoxydable (extérieur et intérieur) qui garantit la durabilité et la résistance.
- Grâce au système de chauffage à induction, une température stable est obtenue dans toute la zone, ce qui réduit l'impact thermique au moment de l'introduction d'aliments.
- Contrôle de la température variable de 60 ° C à 190 ° C.
- Protection contre la surchauffe.
- Équipé d'un robinet de vidange et d'un élément de chauffage caché pour faciliter le nettoyage.
- Couverture et panier inclus.

- Ideal for intensive use in hospitality and kitchens with large workloads.
- Powerful and efficient. 8 L's capacity.
- Built totally in stainless steel (exterior and interior) that guarantees durability and resistance.
- Thanks to the induction heating system, a stable temperature is achieved throughout the area, reducing the thermal impact at the time of introducing food.
- Variable temperature control from 60°C to 190°C.
- Protection against overheating.
- Equipped with emptying tap and hidden heating element to facilitate cleaning.
- Cover and basket included.



Rejilla
Rack



Grifo
Tap



Freidora de inducción

Friteuse à induction · Induktionsfriteuse
Induction fryer · Fritadeira de indução

| Ref | € | W | L | Temperatura | Medidas | U.Venta |
|-------|--------|------|---|-------------|---------------|---------|
| 69465 | 552,10 | 3500 | 8 | 60 - 190°C | 29x57x41,5 cm | 1 |

Freidora Pro

INOX CE  Professional use

- Destinada a un uso intensivo en restaurantes, bares, hoteles, etc.
- Especial para todo tipo de frituras. Permite freir gran cantidad de alimento.
- Fabricada en acero inoxidable, exterior e interior, garantiza una gran durabilidad y resistencia.
- Termostato de temperatura regulable.
- Termostato de seguridad con rearme manual.
- Mango termorresistente.
- Sistema de fijación de la cesta para escurrir el aceite.
- Indicador máximo-mínimo de nivel de aceite.
- Panel extraíble para facilitar el mantenimiento y la limpieza.

- Destiné à un usage intensif dans les restaurants, les bars, les hôtels, etc.
- Spécial pour tous les types de frites. Il permet de faire frire une grande quantité de nourriture.
- Fabriqué en acier inoxydable, extérieur et intérieur, il garantit une grande durabilité et une résistance.
- Thermostat à température réglable.
- Thermostat de sécurité avec arrière manuel.
- Mangué résistante au thermor.
- Système de fixation du panier pour vider l'huile.
- Mimmus maximum du niveau d'huile.
- Panneau amovible pour faciliter l'entretien et le nettoyage.

- Destined for intensive use in restaurants, bars, hotels, etc.
- Special for all types of friedness. It allows to fry a large amount of food.
- Made of stainless, exterior and interior steel, it guarantees great durability and resistance.
- Adjustable temperature thermostat.
- Safety thermostat with manual rear.
- Thermor resistant mango.
- Basket fixing system to drain the oil.
- Maximum-mimmus of oil level.
- Removable panel to facilitate maintenance and cleaning.



Resistencia
Resistance



Grifo
Tap



Freidora Pro

Friteuse · Friteuse
Fryer · Fritadeira

| | Ref | € | W | L | Temperatura | Medidas | U.Venta |
|---|-------|--------|--------|-------|-------------|-------------------|---------|
| A | 69169 | 279,80 | 2500 | 6,0 | 50 - 190°C | 27x41x31 cm | 1 |
| B | 69466 | 437,90 | 2500x2 | 6,0x2 | 50 - 190°C | 58 x 41,5 x 31 cm | 1 |

Simple
Double · Double



Freidora Pro con grifo

Friteuse avec robinet · Friteuse mit Wasserhahn
Fryer with tap · Fritadeira com torneira

| | Ref | € | W | L | Temperatura | Medidas | U.Venta |
|---|-------|--------|--------|-------|-------------|-----------------|-----------------|
| A | 69468 | 296,80 | 3250 | 8,0 | 50-190°C | 27x41x42 cm | Simple |
| B | 69469 | 565,80 | 3250x2 | 8,0x2 | 50-190°C | 51 x 48 x 43 cm | Double · Double |

Freidora Ergo

INOX   Professional use

- Ideal para un uso intensivo en la hostelería y cocinas con grandes cargas de trabajo.
- Potente y eficiente. Capacidad de 8 L.
- Construida totalmente en acero inoxidable (exterior e interior) que garantiza durabilidad y resistencia.
- Gracias al sistema de calentamiento por inducción se consigue una temperatura estable en todo el área, disminuyendo el impacto térmico en el momento de introducir los alimentos.
- Control de temperatura variable de 60°C a 190°C.
- Protección contra el sobrecalentamiento.
- Equipada con grifo de vaciado y elemento de calentamiento oculto para facilitar la limpieza.
- Tapa y cesta incluidas.

- Idéal pour une utilisation intensive dans l'hospitalité et les cuisines avec de grandes charges de travail.
- Puissant et efficace. 8 L's Capacité.
- Construit totalement en acier inoxydable (extérieur et intérieur) qui garantit la durabilité et la résistance.
- Grâce au système de chauffage à induction, une température stable est obtenue dans toute la zone, ce qui réduit l'impact thermique au moment de l'introduction d'aliments.
- Contrôle de la température variable de 60 ° C à 190 ° C.
- Protection contre la surchauffe.
- Équipé d'un robinet de vidange et d'un élément de chauffage caché pour faciliter le nettoyage.
- Couverture et panier inclus.

- Ideal for intensive use in hospitality and kitchens with large workloads.
- Powerful and efficient. 8 L's capacity.
- Built totally in stainless steel (exterior and interior) that guarantees durability and resistance.
- Thanks to the induction heating system, a stable temperature is achieved throughout the area, reducing the thermal impact at the time of introducing food.
- Variable temperature control from 60°C to 190°C.
- Protection against overheating.
- Equipped with emptying tap and hidden heating element to facilitate cleaning.
- Cover and basket included.



Freidora Ergo con grifo

Friteuse avec robinet · Friteuse mit Ablaufhahn
Fryer with tap · Fritadeira com torneira

| Ref | € | W | L | Temperatura | U.Venta |
|-------|--------|------|-----|-------------|---------|
| 69134 | 201,30 | 2500 | 4,0 | 190° max | 1 |



Freidora Ergo

Friteuse · Friteuse
Fryer · Fritadeira

| Ref | € | W | L | Temperatura | U.Venta |
|----------------|--------|------|---------|-------------|---------|
| A 69135 | 116,30 | 2000 | 3,5 | 190° max | 1 |
| B 69170 | 233,00 | 4000 | 3,5 x 2 | 190° max | 1 |

Simple · Simple
Doble · Double

Freidora eléctrica Vue

INOX   Household use

new

- Freidora eléctrica con diseño compacto fabricada en acero inoxidable.
- Cubeta interior de 2,50 L con marcas de capacidad y recubrimiento antiadherente 100% libre de PFOA.
- Temperatura regulable hasta 190°C.
- Temporizador: Preestablece el tiempo de fritura deseado hasta 30min.
- Máximo control: Tapa con ventana para controlar la fritura y evitar salpicaduras. Dispone de un filtro anti-olores que evita el olor a aceite una vez cocinado.
- Cestillo con mango abatible con apertura y cierre bloqueo y sistema de fijación de la cesta para escurrir el aceite.

- Friteuse électrique compacte en acier inoxydable.
- Chauffage rapide et efficace : résultats parfaits en très peu de temps grâce à sa puissance de 1600W.
- Cuve intérieure de 2,50 litres avec marquage de capacité et revêtement antiadhésif 100 % sans PFOA.
- Température réglable jusqu'à 190°C.
- Minuterie : pré-réglage de la durée de friture souhaitée jusqu'à 30 minutes.
- Contrôle maximal : Couvercle avec fenêtre pour contrôler la friture et éviter les éclaboussures. Il dispose d'un filtre anti-odeur qui empêche l'odeur de l'huile une fois la cuisson terminée.
- Panier avec poignée rabattable avec verrouillage de l'ouverture et de la fermeture et système de fixation du panier pour vidanger l'huile.

- Electric fryer with compact design made of stainless steel.
- Fast and efficient heating: Perfect results in a very short time thanks to its 1600W power.
- 2.50 L inner pan with capacity markings and 100% PFOA-free non-stick coating.
- Adjustable temperature up to 190°C.
- Timer: Pre-sets the desired frying time up to 30min.
- Maximum control: Lid with window to control frying and avoid splashing. It has an anti-odour filter that prevents the smell of oil once cooked.
- Basket with folding handle with opening and closing lock and basket fixing system to drain the oil



Freidora eléctrica Vue

Friteuse électrique · Elektrische Friteuse
Electric fryer · Fritadeira eléctrica

| Ref | € | W | L | Temperatura | U.Venta |
|-------|-------|------|-----|-------------|---------|
| 69448 | 82,40 | 1600 | 2,5 | 190° max | 1 |

Freidora eléctrica Intact

INOX   Household use

new

- Ideal para un uso intensivo en la hostelería y cocinas con grandes cargas de trabajo.
- Potente y eficiente. Capacidad de 8 L.
- Construida totalmente en acero inoxidable (exterior e interior) que garantiza durabilidad y resistencia.
- Gracias al sistema de calentamiento por inducción se consigue una temperatura estable en todo el área, disminuyendo el impacto térmico en el momento de introducir los alimentos.
- Control de temperatura variable de 60°C a 190°C.
- Protección contra el sobrecalentamiento.
- Equipada con grifo de vaciado y elemento de calentamiento oculto para facilitar la limpieza.
- Tapa y cesta incluidas.

- Idéal pour une utilisation intensive dans l'hospitalité et les cuisines avec de grandes charges de travail.
- Puissant et efficace. 8 L's Capacité.
- Construit totalement en acier inoxydable (extérieur et intérieur) qui garantit la durabilité et la résistance.
- Grâce au système de chauffage à induction, une température stable est obtenue dans toute la zone, ce qui réduit l'impact thermique au moment de l'introduction d'aliments.
- Contrôle de la température variable de 60 ° C à 190 ° C.
- Protection contre la surchauffe.
- Équipé d'un robinet de vidange et d'un élément de chauffage caché pour faciliter le nettoyage.
- Couverture et panier inclus.

- Ideal for intensive use in hospitality and kitchens with large workloads.
- Powerful and efficient. 8 L's capacity.
- Built totally in stainless steel (exterior and interior) that guarantees durability and resistance.
- Thanks to the induction heating system, a stable temperature is achieved throughout the area, reducing the thermal impact at the time of introducing food.
- Variable temperature control from 60°C to 190°C.
- Protection against overheating.
- Equipped with emptying tap and hidden heating element to facilitate cleaning.
- Cover and basket included.



Freidora eléctrica Intact

Friteuse électrique · Elektrische Friteuse
Electric fryer · Fritadeira eléctrica

| Ref | € | W | L | Temperatura | U.Venta |
|-------|-------|------|-----|-------------|---------|
| 69447 | 89,90 | 3270 | 4,2 | 190° max | 1 |



Freidora de aire dAirePro



- **RapidAir Technology:** La tecnología de ventilación de aire caliente circula a máxima velocidad y a 360° dentro de la cámara de cocción, garantizando así una distribución uniforme del calor en el interior y una cocción homogénea de todos los alimentos.
- **Máxima versatilidad "9 en 1":** Con los 9 programas automáticos preestablecidos podrás cocinar todo tipo de recetas de forma rápida y sana: patatas fritas, pollo, costilla, verduras, pescado, pizza, incluso deshidratar alimentos.
- **Pantalla Led táctil:** Intuitiva y muy fácil de usar. Control de tiempo (hasta 60 minutos y 6 horas para deshidratar) y ajuste de temperatura de cocción de forma precisa (de 40°C a 200°C).
- **7 accesorios incluidos:** 3 rejillas, bandeja, cestillo redondo, pincho mariposa y asa para cestillo redondo.

- Cuisine maison et saine : Conçue pour frire, déshydrater, cuire, rôti et maintenir au chaud.
- RapidAir Technology : La technologie de ventilation à air chaud circule à une vitesse maximum et à 360° dans la chambre de cuisson, garantissant ainsi une distribution uniforme de la chaleur à l'intérieur et une cuisson homogène de tous les aliments.
- Versatilité maximum « 9 en 1 » : Avec les 9 programmes automatiques préétablis, vous pourrez cuisiner tout type de recettes de façon saine et rapide : frites, poulet, côtes de viande, légumes, poisson, pizza, et même déshydrater des aliments.
- Écran Led tactile : Intuitif et très facile à utiliser. Contrôle de temps (jusqu'à 60 minutes et 6 heures pour déshydrater) et réglage de la température de cuisson de façon précise (de 40°C à 200°C).
- 7 accessoires inclus : 3 grilles, plateau, panier rond, tournebroche et poignée pour panier rond.

- Healthy, homemade cooking: designed to fry, dehydrate, bake, roast and keep food warm.
- RapidAir Technology: the air ventilation technology circulates hot 360°C air at maximum speed inside the cooking chamber, which distributes the heat uniformly inside the oven and guarantees that all food is cooked evenly.
- Maximum "9-in-1" versatility: 9 pre-set automatic programmes for you to cook all kinds of recipes quickly and healthily: chips, chicken, ribs, vegetables, fish, pizza and even dehydrate food.
- LED touch screen: very practical and easy to use. Time control (up to 60 minutes and 6 hours for dehydration) and precise cooking temperature settings (from 40°C to 200°C).
- 7 accessories included: 3 racks, tray, round basket, skewer with clamps and handle for round basket.



Freidora de aire dAirePro
Friteuse airfryer · Aidfryer Heißluft-Fritteuse
Air fryer · Fritedeira de aire

| Ref | € | W | L | Rango temperatura | Tiempo | Medidas | U.Venta |
|-------|--------|-------|------|-------------------|--------|-----------------|---------|
| 69513 | 192,60 | 1700W | 12 L | 40°C-200°C | 1-6h | 32,5x36x37,5 cm | 1 |



Freidora de aire DuploAir



- **11 programas automáticos preestablecidos:** diseñado para freír, hornear, asar, calentar, descongelar y deshidratar.
- **Gran capacidad:** 9 L (dos cestillos extraíbles de 4,5 L de capacidad cada uno).
- **Cestillo doble:** control de tiempo y temperatura independiente. Cocina dos platos distintos al mismo tiempo, manteniendo el aroma y el sabor de cada plato.
- **SyncFinish:** acabado sincronizado. Cocina en ambos cestillos con tiempo y temperatura diferente acabado al mismo tiempo.
- **Tecnología TotalCook:** distribuye el calor de manera uniforme a través del aire caliente.
- **100% ECO y libre de PFAS.**

- 11 Programmes automatiques fournis: Conçu pour faire frire, cuire, rôti, chaleur, dégivrer et déshydrater.
- Grande capacité: 9 L (deux paniers amovibles de 4,5 L de capacité chacun).
- Double panier: contrôle du temps et température indépendante. Cuire deux plats différents en même temps, en gardant l'arôme et le goût de chaque plat.
- Syncfinish: finition synchronisée. Cuisine dans les deux paniers avec un temps et une température différents en même temps.
- Totalcook Technology: distribue la chaleur uniformément dans l'air chaud.
- 100% ECO et exempt de PFAS.

- 11 Automatic programs provided: designed to fry, bake, roast, heat, defrost and dehydrate.
- Great capacity: 9 L (two removable baskets of 4.5 L of capacity each).
- Double basket: time control and independent temperature. Cook two different dishes at the same time, keeping the aroma and taste of each dish.
- Syncfinish: synchronized finish. Kitchen in both baskets with different time and temperature finish at the same time.
- TotalCook technology: distributes heat evenly through hot air.
- 100% ECO and free of PFAS.



Tecnología TotalCook
TotalCook Technology

Incluye rejilla
Grid included

Freidora de aire DuploAir
Friteuse airfryer · Aidfryer Heißluft-Fritteuse
Air fryer · Fritedeira de aire

| Ref | € | W | L | Rango temperatura | Tiempo | Medidas | U.Venta |
|-------|--------|------|----------|-------------------|----------|-----------------|---------|
| 69508 | 218,40 | 2400 | 4 L (x2) | 45°C - 200°C | 1-60 min | 41x33,5x31,5 cm | 1 |





Freidora de aire CrystalFry



Household use

- 8 programas automáticos preestablecidos para cocinar todo tipo de recetas de forma rápida y sana: patatas fritas, alitas de pollo, pizza etc. garantizando resultados sorprendentes.
- Todas las funciones disponen de un tiempo de precalentamiento para conseguir resultados óptimos
- Tecnología TotalCook: distribuye el calor de manera uniforme a través del aire caliente a gran velocidad.
- Gran capacidad: 7,0 litros.
- Intuitiva y muy fácil de usar: gracias a la pantalla digital se puede ajustar el tiempo (hasta 60 minutos), la temperatura (de 40°C a 200°C.) y los 8 programas preestablecidos.
- Cestillo extraíble con antiadherente 100% libre de PFAS. Libre de BPA.

- 8 programmes automatiques pré-réglés pour cuire rapidement et sainement toutes sortes de recettes: frites, ailes de poulet, pizza, etc. garantissant des résultats étonnants.
- Toutes les fonctions ont un temps de préchauffage afin d'obtenir des résultats optimaux.
- Technologie TotalCook : distribue la chaleur de manière homogène à travers l'air chaud à grande vitesse.
- Grande capacité : 7,0 litres.
- Intuitif et très facile à utiliser : grâce à l'affichage numérique, vous pouvez régler le temps (jusqu'à 60 minutes), la température (de 40°C à 200°C) et les 8 programmes prédéfinis.
- Panier amovible avec revêtement antiadhésif sans PFAS. Sans BPA.

- It has 8 pre-set automatic programmes for making all kinds of recipes in a fast and healthy way: chips, chicken wings, pizza, etc. with excellent results guaranteed.
- All the functions have a preheating time to get optimal results.
- TotalCook Technology: It distributes heat uniformly with high speed hot air.
- High capacity: 7,0 litres.
- Intuitive and very easy to use: Thanks to the digital screen, you can set the time (up to 60 minutes), temperature (from 40°C to 200°C) and use 8 pre-set programmes.
- TotalControl: controls the cooking process thanks to glass door and interior light.
- The removable non-stick basket is 100% PFAS free. BPA free.



Tecnología TotalCook
TotalCook
Technology



Incluye rejilla
Grid included



TotalControl: controla el cocinado gracias a la puerta de cristal y la luz interior

TotalControl: control the cooking process thanks to glass door and interior light



Freidora de aire CrystalFry

Friteuse airfryer · Aidfryer Heißluft-Fritteuse
Air fryer · Friteadeira de aire

| Ref | € | W | L | Rango temperatura | Tiempo | Medidas | U.Venta |
|-------|--------|------|-----|-------------------|----------|---------------|---------|
| 69515 | 130,40 | 1700 | 7,0 | 40°-200°C | 0-60 min | 41x30x34,5 cm | 1 |



Freidora de aire EcoFry



Household use

- 8 programas automáticos preestablecidos para cocinar todo tipo de recetas de forma rápida y sana: patatas fritas, alitas de pollo, pizza etc.
- Todas las funciones disponen de un tiempo de precalentamiento para conseguir resultados óptimos
- Tecnología TotalCook: distribuye el calor de manera uniforme a través del aire caliente a gran velocidad.
- Gran capacidad: 5,5 litros (cestillo).
- Intuitiva y muy fácil de usar: gracias a la pantalla digital se puede ajustar el tiempo (hasta 60 minutos), la temperatura (de 40°C a 200°C) y los 8 programas preestablecidos.
- Cestillo extraíble con antiadherente 100% libre de PFAS.

- 8 Programmes automatiques pré-établis pour cuisiner toutes sortes de recettes rapidement et saines: pommes de terre frites, ailes de poulet, pizza, etc.
- Toutes les fonctions ont un temps de préchauffage pour obtenir des résultats optimaux
- Totalcook Technology: distribue la chaleur uniformément dans l'air chaud à grande vitesse.
- Grande capacité: 5,5 litres (panier).
- Intuitif et très facile à utiliser: grâce à l'écran numérique, vous pouvez ajuster le temps (jusqu'à 60 minutes), la température (de 40 ° C à 200 ° C) et les 8 programmes pré-établi.
- Panier amovible avec 100% sans PFAS.

- 8 Pre-established automatic programs for cooking all kinds of recipes quickly and healthy: fried potatoes, chicken wings, pizza etc.
- All functions have a preheating time to achieve optimal results
- TotalCook technology: distributes heat evenly through hot air at high speed.
- Great capacity: 5.5 liters (basket).
- Intuitive and very easy to use: Thanks to the digital screen you can adjust the time (up to 60 minutes), the temperature (from 40°C to 200°C) and the 8 pre-established programs.
- Removable basket with 100% free of PFAS.
- Easy cleaning: accessories suitable for dishwasher.



Incluye rejilla
Grid included



Tecnología TotalCook
TotalCook
Technology

Freidora de aire EcoFry

Friteuse airfryer · Aidfryer Heißluft-Fritteuse
Air fryer · Friteadeira de aire

| Ref | € | W | Capacidad cestillo | Rango temperatura | Medidas | U.Venta |
|-------|--------|------|--------------------|-------------------|---------------|---------|
| 69511 | 175,70 | 1700 | 5,5L | 40°C - 200°C | 41x30x34,5 cm | 1 |





Freidora de aire VitalCook



- **Cocina casera y saludable: diseñada para freír, hornear, asar y calentar sin apenas utilizar aceite.**
- **Cocina todo tipo de recetas de forma rápida y sana: patatas fritas, alitas de pollo, etc. garantizando resultados sorprendentes.**
- **Tecnología TotalCook: distribuye el calor de manera uniforme a través del aire caliente a gran velocidad.**
- **Capacidad: 3,0 litros.**
- **Recipiente extraíble con antiadherente 100% libre de PFAS. Libre de BPA.**

- Cuisine maison et saine: conçue pour faire frire, cuire, rôtir et chauffer sans utiliser d'huile.
- Cuisine tous les types de recettes rapidement et en bonne santé: pommes de terre frites, ailes de poulet, etc. garantir des résultats surprenants.
- TotalCook Technology: distribue la chaleur uniformément dans l'air chaud à grande vitesse.
- Capacité: 3,0 litres.
- Conteneur amovible avec 100% sans PFAS.
- Il comprend un livre de recettes exclusif et conçu par Lacor en 3 langues. Sans BPA.

- Homemade and healthy kitchen: designed to fry, bake, roast and heat without using oil.
- Kitchen all types of recipes quickly and healthy: fried potatoes, chicken wings, etc. guaranteeing surprising results.
- TotalCook technology: distributes heat evenly through hot air at high speed.
- Capacity: 3.0 liters.
- Removable container with 100% free of PFAS..
- BPA free.



Incluye rejilla
Grid included

Tecnología
TotalCook
TotalCook
Technology



Freidora de aire VitalCook
Friteuse airfryer · Aidfryer Heißluft-Fritteuse
Air fryer · Fritedeira de aire

| Ref | € | W | L | Tiempo | Rango temperatura | Medidas | U.Venta |
|-------|--------|------|-----|--------------|-------------------|-------------|---------|
| 69509 | 110,50 | 1000 | 3 L | 1-60 minutos | 40°C - 200°C | 34x25x33 cm | 1 |

Hornos sobremesa



- **Horno eléctrico de sobremesa de convección con carcasa de acero en acabado negro.**
- **Alto rendimiento en un diseño compacto.**
- **Manejable y funcional.**
- **5 funciones predefinidas y temporizador de 0-120 minutos con señal sonora.**
- **Temperatura ajustable máx. de 230°C.**
- **Transfiere el calor a través de 4 resistencias.**
- **Pared de aislamiento y puerta abatible de doble cristal de alta resistencia.**
- **Luz interior que permite vigilar el proceso.**
- **Revestimiento antiadherente interior para una fácil limpieza. 100% libre de PFOA.**
- **Incluye: bandeja para hornear, parrilla, pinza para bandeja, rustidor giratorio, mango para el rustidor y bandeja recogemigas.**

- Cour de bureau de convection électrique avec boîtier en acier en finition noire.
- Haute performance dans une conception compacte.
- Gérable et fonctionnel.
- 5 fonctions prédéfinies et minuterie de 0 à 120 minutes avec un signal sonore.
- Max. de 230 ° C.
- Il transfère la chaleur à travers 4 résistances.
- Mur d'isolement et porte en verre à double résistance pliante.
- Lumière intérieure qui permet de surveiller le processus.
- Doublure anti-intérieure pour un nettoyage facile. 100% sans PFOA.
- Comprend: plateau à pâtisserie, gril, collier de plateau, rouille rotative, manguue pour le roullain et les récupérations du plateau.

- Electrical convection desk oven with steel housing in black finish.
- High performance in a compact design.
- Manageable and functional.
- 5 predefined functions and timer of 0-120 minutes with a sound signal.
- Max. of 230°C.
- It transfers heat through 4 resistances.
- Isolation wall and folding double-resistance glass door.
- Interior light that allows to monitor the process.
- Interior antiating lining for easy cleaning. 100% free from PFOA.
- Includes: baking tray, grill, tray clamp, rotating rusting, mango for the rustor and tray collects.



Horno sobremesa

Four à poser · Tischbackofen
Countertop oven · Forno de mesa

| Ref | € | W | L | Rango temperatura | Tiempo | Medidas internas | U.Venta |
|---------|--------|------|----|-------------------|-----------|------------------|---------|
| A 69327 | 223,80 | 1650 | 28 | 70°C - 230°C | 0-120 min | 34,5x28x20 cm | 1 |
| B 69347 | 251,40 | 1850 | 35 | 70°C - 230°C | 0-120 min | 36,5x28,5x23 cm | 1 |



Horno halógeno convección Glass

Four à convection halogène · Obstrockner, Elektrisc
Convection halogen glass oven · Forno de vidro

| Ref | € | W | L | Rango temperatura | Tiempo | Medidas | U.Venta |
|-------|-------|------|------|-------------------|----------|-------------|---------|
| 69312 | 97,40 | 1400 | 12 L | 125°C - 250°C | 0-60 min | 41x33x31 cm | 1 |



Mecanismo de ciclo de aire caliente
Hot air cycle mechanism

- **Funciones: asar, cocer, hervir, freír, gratinar, tostar y descongelar.**
- **Reduce el nivel de grasa de los alimentos.**
- **2 mandos: temporizador y nivel de temperatura.**
- **Capacidad: 12 L con la posibilidad de 5 L adicionales.**

- Fonctions: Rôtir, cuisiner, bouillir, frire, gratin, toast et déglacer.
- Réduit le niveau de graisse alimentaire.
- 2 Commandes: Timer et niveau de température.
- Capacité: 12 L avec la possibilité de 5 supplémentaires.

- Functions: roasting, cooking, boiling, frying, gratin, toast and defrost.
- Reduces food fat level.
- 2 controls: timer and temperature level.
- Capacity: 12 L with the possibility of additional 5.

Horno pizza Lecco

new

Cordierita INOX CE  Professional use

- Estructura fabricada en acero inoxidable de gran calidad.
- Horno eléctrico con aislamiento térmico.
- Ideal para hornear pizzas, panes, tartas, etc. en cualquier restaurante, cafetería o bar.
- Obtén pizzas con una base crujiente y dorada, gracias a la piedra de cordierita 100% natural de alta resistencia al calor de 40x40 cm
- Equipado con iluminación interior y puerta con doble cristal atermico para controlar el proceso con seguridad.
- La temperatura de la parte superior e inferior se puede ajustar por separado con termostatos independientes.
- Rango de temperatura de 0 a 300°C.

- Structure en acier inoxydable de haute qualité.
- Four électrique avec isolation thermique.
- Idéal pour la cuisson de pizzas, pains, gâteaux, etc. dans tout restaurant, cafétéria ou bar.
- Obtenez des pizzas avec une base croustillante et dorée, grâce à la pierre en cordierite 100 % naturelle à haute résistance thermique de 40x40 cm.
- Équipé d'un éclairage intérieur et d'une porte à double vitrage athermique pour contrôler le processus en toute sécurité.
- La température de la partie supérieure et de la partie inférieure peut être réglée séparément à l'aide de thermostats indépendants.
- Plage de température de 0 à 300°C.

- Structure made of high quality stainless steel.
- Thermally insulated electric oven.
- Ideal for baking pizzas, bread, cakes, etc. in any restaurant, café or bar.
- The 40 x 40 cm 100% natural, highly heat-resistant cordierite stone
- guarantees pizzas with a crispy, golden base.
- Includes interior lighting and a double-glazed athermic door to safely monitor the cooking process.
- Separate thermostats allow upper and lower temperatures to be individually adjusted.
- Temperature range: 0 to 300°C.



100% natural high strength cordierite stone
100% natural high strength cordierite stone



Horno pizza Lecco
Four à pizza · Pizaofen
Pizza oven · Forno para pizza

| Ref | € | W | Temperatura | Medidas | U.Venta |
|---------|--------|------|-------------|-------------|---------|
| A 69632 | 333,40 | 2000 | 300°C | 57x56x28 cm | 1 |
| B 69633 | 475,70 | 3000 | 300°C | 57x56x44 cm | 1 |

Microondas

INOX 18/10 CE 



Household use

Horno microondas Fast

Four micro-ondes avec plateau tournant + Grill · Mikrowelle mit Drehteller + Grill
Microwave oven with turntable + grill · Microondas com prato giratório + grill

| Ref | € | W | L | Medidas internas | Medidas | U.Venta |
|-------|--------|-------|------|------------------|---------------|---------|
| 69330 | 361,00 | 900 W | 30 L | 33x35,5x22,5 cm | 52x40x32,5 cm | 1 |



Professional use

Microondas Tempo

Micro-ondes · Mikrowelle
Microwave · Microondas

| Ref | € | W | L | Medidas internas | Medidas | U.Venta |
|-------|--------|------|----|------------------|-------------|---------|
| 69329 | 500,60 | 1550 | 25 | 32x32x19 cm | 51x43x31 cm | 1 |



Household use

Microondas White

Micro-ondes · Mikrowelle
Microwave · Microondas

| Ref | € | W | L | Medidas internas | Medidas | U.Venta |
|-------|--------|-----|----|------------------|---------------|---------|
| 69322 | 162,20 | 700 | 20 | 31,5x30x20 cm | 45x33,5x26 cm | 1 |



Professional use

Horno microondas Profesional

Four à micro ondes professionnel · Mikrowelle Professional
Professional microwave oven · Microondas profesional

| Ref | € | W | L | Medidas internas | Medidas | U.Venta |
|-------|--------|------|----|------------------|-------------|---------|
| 69325 | 645,60 | 1000 | 25 | 32x32x19 cm | 51x43x31 cm | 1 |



Household use

Horno microondas Energy

Four micro-ondes avec plateau tournant + Grill · Mikrowelle mit Drehteller + Grill
Microwave oven with turntable + grill · Microondas com prato giratório + grill

| Ref | € | W | L | Medidas internas | Medidas | U.Venta |
|-------|--------|-----|----|------------------|---------------|---------|
| 69323 | 275,50 | 800 | 23 | 33x32x20,5 cm | 48,5x41x29 cm | 1 |



Household use

Horno microondas Micro

Four micro-ondes avec plateau tournant + Grill · Mikrowelle mit Drehteller + Grill
Microwave oven with turntable + grill · Microondas com prato giratório + grill

| Ref | € | W | L | Medidas internas | Medidas | U.Venta |
|-------|--------|------------|------|------------------|-------------|---------|
| 69324 | 299,90 | 900-1450 W | 25 L | 35,5x33x21 cm | 51x43x30 cm | 1 |

Placas de inducción

INOX   *Professional use*

- Placas de inducción rápidas, eficaces, seguras, fiables y de gran capacidad de calentamiento.
- Sus diseños portátiles y compactos resultan ideales para su uso en cualquier lugar.
- Botones táctiles, intuitivos y fáciles de utilizar con un toque suave.
- Dispone de función de bloqueo de seguridad para niños.
- 40% ahorro de tiempo y energía respecto a otras placas convencionales.

- Plaque à induction rapide, efficace, sûre, fiable et d'une grande capacité de chauffe.
- Sa conception portable et compacte est idéale pour une utilisation n'importe où.
- Boutons tactiles, intuitifs et faciles à utiliser avec un toucher doux.
- Dispose d'une fonction de blocage de sécurité pour les enfants.
- 40% de gain de temps et d'économies d'énergies par rapport à d'autres plaques conventionnelles

- Fast, efficient, safe, reliable induction hob with high heating capacity.
- Its portable and compact design is ideal for use anywhere.
- Intuitive and easy to use soft touch buttons.
- Includes a child safety lock function.
- 40% saving in time and energy compared to other conventional hobs.

Superficie de calentamiento
Heating surface



IPX3
proof



Placa de inducción Profesional Chef

Plaque induction professionnelle · Profi-Induktionsplatte
Professional induction cooktop · Placa de indução profissional

| Ref | € | W | Niveles potencia | Tiempo | Medidas | U.Venta |
|-------|--------|------|------------------|---------|-------------|---------|
| 69132 | 443,20 | 3500 | 17 | 180 min | 34x43x12 cm | 1 |

Superficie de calentamiento
Heating surface



Placa de inducción profesional Easy

Plaque induction professionnelle · Profi-Induktionsplatte
Professional induction cooktop · Placa de indução profissional

| Ref | € | W | Niveles potencia | Medidas | U.Venta |
|-------|--------|------|------------------|-----------------|---------|
| 69362 | 380,20 | 3500 | 10 | 34x44,5x12,5 cm | 1 |

Superficie de calentamiento
Heating surface



Placa de inducción profesional Roca

Plaque induction professionnelle · Profi-Induktionsplatte
Professional induction cooktop · Placa de indução profissional

| Ref | € | W | Niveles potencia | Tiempo | Medidas | U.Venta |
|-------|--------|------|------------------|---------|-------------|---------|
| 69337 | 374,70 | 2700 | 10 | 180 min | 30x39x10 cm | 1 |

Superficie de calentamiento
Heating surface



Placa de inducción Pro

Table de cuisine à induction · Induktionskochfeld
Induction cooker · Placa de indução

| Ref | € | W | Niveles potencia | Medidas | U.Venta |
|-------|--------|------|------------------|---------------|---------|
| 69371 | 343,00 | 3500 | 10 | 36x38x12,5 cm | 1 |



Superficie de calentamiento
Heating surface



Placa de inducción Slim

Table de cuisine à Induktion · Induktionskochfeld
Induction cooker · Placa de indução

| Ref | € | W | Niveles potencia | Tiempo | Medidas | U.Venta |
|-------|--------|------|------------------|---------|--------------|---------|
| 69332 | 162,70 | 2000 | 8 | 180 min | 30x37x4,5 cm | 1 |

Superficie de calentamiento
Heating surface



Placa de inducción Dual Vertical

Plaque induction double · Induktionskochfeld doppelt
Double induction cooktop · Placa de indução dupla

| Ref | € | W | Niveles potencia | Tiempo | Medidas | U.Venta |
|-------|--------|-----------|------------------|----------|------------|---------|
| 69033 | 469,70 | 1800+1300 | 8 | 0-99 min | 29x51x9 cm | 1 |

Posibilidad de encastrar
Encastrable option

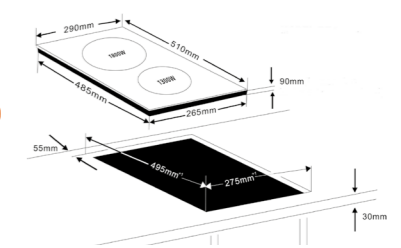

Superficie de calentamiento
Heating surface



Placa de inducción Expert

Table de cuisine à induction · Induktionskochfeld
Induction cooker · Placa de indução

| Ref | € | W | Niveles potencia | Tiempo | Medidas | U.Venta |
|-------|--------|------|------------------|-----------|--------------|---------|
| 69032 | 286,90 | 2000 | 6 | 0-180 min | 31x36x7,5 cm | 1 |

Superficie de calentamiento
Heating surface



Placa de inducción Dual Horizontal

Plaque induction · Induktionskochfeld doppelt
Induction cooktop · Placa de indução

| Ref | € | W | Niveles potencia | Tiempo | Medidas | U.Venta |
|-------|--------|-----------|------------------|-------------|------------------|---------|
| 69333 | 277,60 | 2000+1500 | 7 | 0 - 180 min | 60 x 34 x 7,5 cm | 1 |

Posibilidad de encastrar
Encastrable option

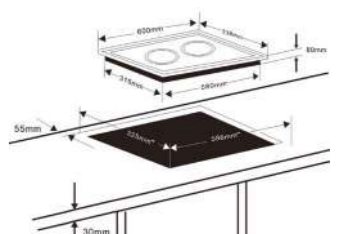

Placa cerámica: Ø26 cm
Ceramic plate: Ø26 cm



INOX

Placa de inducción Wok Profesional

Plaque à induction wok professionnelle · Induktionskochplatte wok professional
Induction cooktop wok professional · Placa indução wok profissional

Wok Trimetal

Wok Trimetal · Wok, Trimetal
Trimetal wok · Wok Trimetal

| Ref | € | W | Tiempo | Medidas | U.Venta |
|-------|--------|--------|---------|-----------------|---------|
| 69138 | 460,20 | 3500 W | 180 min | 34x44,5x12,5 cm | 1 |

| Ref | € | Ø (cm) | h(cm) | e (mm) | L | U.Venta |
|-------|--------|--------|---------|--------|------|---------|
| 53836 | 179,20 | 36 | 10,5 cm | 2,7 mm | 5,50 | 1 |

Placa Vitrocerámica Energy

INOX CE Household use

- Placa vitrocerámica rápida, eficaz, segura, fiable y de gran capacidad de calentamiento.
- Su diseño portátil y compacto resulta ideal para su uso en cualquier lugar.
- Área de cocción de 10 cm / 20 cm de diámetro.
- Botones táctiles, intuitivos y fáciles de utilizar con un toque suave.
- Indicadores luminosos.
- Dispone de función de bloqueo de seguridad para niños.
- Regulable en potencia y temperatura.
- Temporizador de 240 minutos con avisador acústico y auto desconexión.

- Plaque de capacité rapide, efficace, sûre, fiable et de chauffage.
- Sa conception portable et compacte est idéale pour une utilisation n'importe où.
- Zone de cuisson de 10 cm / 20 cm de diamètre.
- Boutons tactiles, intuitifs et faciles à utiliser avec une touche douce.
- Indicateurs lumineux.
- Il a une fonction de verrouillage de sécurité des enfants.
- Réglable en puissance et en température.
- Timer de 240 minutes avec avertissement acoustique et auto-déconnexion.

- Fast, effective, safe, reliable and heating capacity plate.
- Its portable and compact design is ideal for use anywhere.
- Cooking area of 10 cm / 20 cm in diameter.
- Tactile buttons, intuitive and easy to use with a soft touch.
- Luminous indicators.
- It has children's security lock function.
- Adjustable in power and temperature.
- 240 minutes timer with acoustic warning and self -disconnection.

Superficie de calentamiento
Heating surface



Placa Vitrocerámica Energy

Plaque vitroceramique · Keramikkochfeld
Ceramic hob · Placa vitrocerámica

| Ref | € | W | Niveles potencia | Tiempo | Superficie placa | Medidas | U.Venta |
|-------|--------|------|------------------|-------------|------------------|--------------|---------|
| 69232 | 115,40 | 2000 | 8 | 240 minutos | Ø10-20 cm | 39x32x5,5 cm | 1 |

Planchas grill

INOX CE Professional use



- Estructura de acero inoxidable.
- Ideal para calentar, asar, tostar o gratinar directamente los alimentos.
- Placa de calentamiento y techo móvil, ajusta a la posición deseada.

- Structure en acier inoxydable.
- Idéale pour chauffer, rôtir, griller ou gratiner directement les aliments.
- Plaque de chauffe et toit mobile avec réglage de la position souhaitée.

- Stainless steel structure.
- Ideal for directly heating, roasting, toasting or browning food.
- Movable heating plate and roof, adjusting the desired position

Salamandra Profesional

Salamandre Professionnelle · Professioneller Grill
Professional salamander grill · Salamandra Profissional

| Ref | € | W | Rango temperatura | Superficie placa | Medidas | U.Venta |
|-------|---------|------|-------------------|------------------|-------------|---------|
| 69197 | 1250,80 | 4000 | 50°C - 300°C | 59 x 32 cm | 60x45x50 cm | 1 |

A



- Fabricada en acero inoxidable.
- Protector de salpicaduras.
- Placa con superficie lisa de acero laminado y rectificado, calentamiento uniforme.
- Control de temperatura por termostato hasta 300°C.
- Depósito recoge grasas.

- En acier inoxydable.
- Protecteur de éclaboussures.
- Plaque avec surface en acier lancée et rectifiée, chauffage uniforme.
- Contrôle de la température du thermostat jusqu'à 300 ° C.
- Le dépôt collecte les graisses.

- Made of stainless steel.
- Splash protector.
- Plate with smooth rolled and rectified steel surface, uniform heating.
- Thermostat temperature control up to 300°C.
- Deposit collects fats.

B



Cuchillas de acero inoxidable
Interchangeable
st. steel
blades

INOX CE

Placa grill profesional

Gril Professionnel · Profi-Grill
Professional grill plate · Grelhador Profissional

| Ref | € | W | Área de cocción | Rango temperatura | Medidas | U.Venta |
|---------|--------|------|-----------------|-------------------|---------------------|------------------|
| A 69379 | 396,00 | 3000 | 40x40 cm | 300°C (max) | 40 x 50,3 x 28,5 cm | 1 Simple |
| B 69179 | 813,50 | 6000 | 61x40 cm | 300°C (max) | 61,5x51x26 cm | 1 Doble · Double |

AL FUNDIDO
Aluminium Cast

Rasqueta profesional para Grill

Racloir professionnel pour grill · Professioneller grillschaber
Professional grill scraper · Raspador profesional para grill

| Ref | € | Cuchilla (cm) | Medidas | U.Venta |
|-------|-------|---------------|-------------|---------|
| 67034 | 72,60 | 15 | 42x15x12 cm | 1 |

Plancha Grill Quality



Household use

- Placa de aluminio fundido antiadherente de gran calidad, libre de PFOA.
- Doble zona de cocción para cocinar todo tipo de alimentos:
 - 1) Grill: ideal para asar carnes, pescados, marisco, hamburguesas o verduras.
 - 2) Lisa: ideal para preparar tortitas, huevos, tostadas o verduras.
- Alcanzan rápidamente la temperatura indicada.
- Garantizan una cocción uniforme por toda la superficie.
- Regulador de temperatura desmontable.
- La ranura central hace que la grasa se deposite en la bandeja recoge-grasas.
- Las asas con recubrimiento aislante de calor proporcionan seguridad.

- Plaque en aluminium fondu de grande qualité, exempté de PFOA.
- Aire à double cuisson pour cuisiner toutes sortes de nourriture:
 - 1) Grill: idéal pour rôtir les viandes, le poisson, les fruits de mer, les hamburgers ou les légumes.
 - 2) Lisa: idéal pour préparer des crêpes, des œufs, du pain grillé ou des légumes.
- Ils atteignent rapidement la température indiquée.
- Ils garantissent une cuisson uniforme sur toute la surface.
- Régulateur de température amovible.
- La fente centrale fait déposer la graisse dans le plateau rassemblé.
- Les poignées thermiques à isolation offrent la sécurité.

- Molten aluminum plaque of great quality, free of PFOA.
- Double cooking area for cooking all kinds of food:
 - 1) Grill: Ideal for roasting meats, fish, seafood, hamburgers or vegetables.
 - 2) Lisa: Ideal for preparing pancakes, eggs, toast or vegetables.
- They quickly reach the indicated temperature.
- They guarantee a uniform cooking throughout the surface.
- Removable temperature regulator.
- The central slot causes the fat to be deposited in the gathered tray.
- Heat insulating coat handles provide safety.



Plancha Grill Quality

Plancha & Grill · Grillplatte
Grill plate · Prancha & Grelhador

| Ref | € | W | Temperatura | Medidas | U.Venta |
|-------|-------|------|-------------|------------------------------|---------|
| 69227 | 86,70 | 2000 | 230°C | 61x32,5x6 cm (sin regulador) | 1 |

Plancha grill Due

new



Household use

- Amplia superficie de cocción de 50x30 cm dividida en dos zonas: grill y lisa.
- Placa antiadherente extraíble de máxima calidad, 100% libre de PFOA.
- Distribución homogénea del calor en toda la superficie de cocción.
- Diseñada para cocinar tanto en interior como en exterior.
- Protector anti-salpicaduras y viento fabricado en acero inoxidable.
- Dos termostatos regulables e independientes con 5 posiciones de temperatura.
- Bandeja recoge grasas extraíble.

- Grande surface de cuisson de 50 x 30 cm divisée en deux zones : grill et lisse.
- Plaque antiadhérente amovible de la plus haute qualité, 100 % sans PFOA.
- Distribution uniforme de la chaleur sur toute la surface de cuisson.
- Conçue pour la cuisson à l'intérieur et à l'extérieur.
- Protection contre les éclaboussures et le vent en acier inoxydable.
- Deux thermostats indépendants réglables avec 5 niveaux de température.
- Bac à graisse amovible.

- Large 50x30 cm cooking surface divided into two areas: grill and smooth.
- Removable high quality non-stick hotplate, 100% PFOA free.
- Even heat distribution over entire cooking surface.
- Designed for both indoor and outdoor use.
- Stainless steel splash and wind guard.
- Two individual adjustable thermostats with 5 temperature settings.
- Removable grease drip tray.

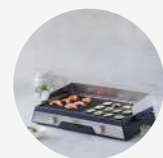

Plancha grill Due

Planche grill · Grillplatte
Grill plate · Prancha grelhador

| Ref | € | W | Temperatura | Medidas | U.Venta |
|-------|--------|------|-------------|-----------|---------|
| 69570 | 174,60 | 2400 | 220°C | 57 x 32,5 | 1 |



Raclette grill



Household use

- Raclette fabricado con carcasa de acero inoxidable y placa de aluminio fundido con antiadherente de máxima calidad. Libre de PFOA.
- Placa reversible que dispone de una superficie acanalada y otra lisa. Superficie de cocción de 41x20 cm.
- Ajuste de temperatura variable (hasta 210°C) con anillo luminoso.
- Resistencia de 1400W distribuida uniformemente por toda la superficie para un calentamiento rápido y uniforme de los alimentos.
- 8 sartenes individuales con revestimiento esmaltado diferenciados por colores. Libres de PFOA.
- 8 espátulas de madera de haya para remover los alimentos y facilitar el momento de servir.
- Protección contra sobrecalentamiento.
- Fácil de limpiar; placa y sartenes extraíbles.

- Raclette fabriqué avec un boîtier en acier inoxydable et une plaque en aluminium fondu avec une qualité supérieure antiadhésive. PFOA gratuit.
- Plaque réversible qui a une surface rainurée et une autre lisse. Surface de cuisson de 41x20 cm.
- Réglage de la température variable (jusqu'à 210°C) avec un anneau léger.
- 1400W Résistance distribuée uniformément dans la surface pour un chauffage alimentaire rapide et uniforme.
- 8 Pans individuels avec revêtement émaillé différencié par les couleurs. Libre de PFOA.
- 8 spatules en bois de hêtre pour enlever les aliments et faciliter le temps de servir.
- Protection de surchauffe. Facile à nettoyer; Assiette amovible et casseroles.

- Raclette manufactured with stainless steel housing and molten aluminum plate with top quality nonstick. PFOA free.
- Reversible plate that has a grooved surface and another smooth. Cooking surface of 41x20 cm.
- Variable temperature adjustment (up to 210°C) with light ring.
- 1400W resistance distributed evenly throughout the surface for rapid and uniform food heating.
- 8 individual pans with enameled coating differentiated by colors. Free from PFOA.
- 8 beech wood spatulas to remove food and facilitate the time to serve.
- Overheating protection. Easy to clean; removable plate and pans.



Termostato regulable
Adjustable thermostat



8 sartenes individuales
8 individual frying pans



Apta hasta 8 personas
Suitable up to 8 people



Plancha y parrilla reversibles.
Reversible flat and grill plate.

Raclette grill

Raclette Grill · Raclette-Grill
Grill raclette · Raclette Grill

| Ref | € | W | Temperatura | Medidas | U.Venta |
|-------|-------|------|-------------|-----------------|---------|
| 69348 | 94,10 | 1400 | 210°C | 48x37,5x14,5 cm | 1 |





Grill abatible Totally & Controlle

INOX    Household use

- Diseñados para preparar sándwiches, paninis, verdura, carne, etc.
- 69572 - DualFunction: grill y plancha de asar; apertura 180° para aprovechar al máximo la superficie de cocinado doble.
- 69573 - Regulador de altura en 4 posiciones: ideal para alimentos delicados. Regulador de temperatura: regula la potencia de las placas para conseguir la cocción deseada (240°C máx).
- Placas de aluminio fundido antiadherente de máxima calidad, ECO y 100% libres de PFOA.
- Disponen de una bandeja de goteo extraíble apta para el lavavajillas.
- GreenLed: indicador luminoso de temperatura.
- TotalSafe: sistema antiquemadura. La carcasa y el asa permanecen fríos durante el uso

- Conçu pour préparer sandwichs chauds, paninis, légumes, viandes, etc.
- 69572 - DualFunction : grill et plancha ; ouverture à 180° pour exploiter au maximum la surface de cuisson double.
- 69573 - Réglage en hauteur en 4 positions : Idéal pour les aliments délicats. Régulateur de température : Régle la puissance des plaques pour obtenir la cuisson souhaitée (240°C max.).
- Plaques en fonte d'aluminium antiadhésif de la plus grande qualité, ECO et 100% sans PFOA.
- Dispose d'un plateau recueille-gouttes extractible apte pour le lave-vaisselle.
- GreenLed: indicateur de température lumineux.
- TotalSafe : système anti-brûlures. La carcasse et la poignée restent froides pendant son utilisation.

- Designed to prepare sandwichs, paninis, vegetables, meat, etc.
- 69572 - DualFunction: Grill and griddle; fully opens 180° to maximise use of the double cooking area
- 69573 - Height adjustment in 4 positions: ideal for delicate foods. Temperature control: regulates heat of the hotplates to achieve the desired degree of doneness (240°C max.).
- Non-stick cast aluminium hotplates of the highest quality, ECO and 100% PFOA free.
- Features a removable, dishwasher-safe drip tray.
- GreenLed: temperature indicator light.
- TotalSafe: anti-burn system. Housing and handle remain cool during use.



Grill abatible Totally

Grill rabattable · Klappgrill
Contact grill · Grelhador abatível

| Ref | € | W | Temperatura | Área de cocción | Medidas | U. Venta |
|-------|-------|------|-------------|-----------------|-------------|----------|
| 69572 | 52,80 | 1500 | 180°C | 26x16,5 cm (x2) | 32x27x11 cm | 1 |

Grill abatible Controlle

Grill rabattable · Klappgrill
Contact grill · Grelhador abatível

| Ref | € | W | Temperatura | Área de cocción | Medidas | U. Venta |
|-------|-------|------|-------------|-----------------|-----------------|----------|
| 69573 | 98,10 | 1500 | 240°C | 27x17,5 cm | 33,5x28x12,5 cm | 1 |



Grill abatible Pro

Grill rabattable · Klappgrill
Contact grill · Grelhador abatível

| Ref | € | W | Temperatura | Superficie placa | Medidas | U. Venta |
|-------|--------|------|-------------|------------------|-------------|----------|
| 69574 | 268,70 | 2000 | 230°C | 27x22 cm | 38x35x17 cm | 1 |



- Grill de gran calidad y robusto para uso profesional.
- Placas extraíbles de aluminio fundido antiadherente de gran calidad, libre de PFOA.
- Doble zona de cocción: 1) Grill (27x22 cm): ideal para asar carnes, pescados, marisco, hamburguesas o verduras. 2) Lisa (27x22 cm): ideal para preparar tortitas, huevos, tostadas o verduras.
- Alcanza rápidamente la temperatura indicada. Garantiza una cocción uniforme por toda la superficie.
- Regulación en altura. Regulador de potencia y temporizador de 30 minutos.
- Fácil extracción (botón) y colocación de las placas para facilitar su limpieza.
- Bandeja recoge grasas. Base antideslizante.
- Incluye espátula para la limpieza de las placas.

- Grill of great quality and robust for professional use.
- Removable molten aluminum plates of great quality, free of PFOA.
- Double cooking zone: 1) grill (27x22 cm): Ideal for roasting meats, fish, seafood, hamburgers or vegetables. 2) Lisa (27x22 cm): Ideal for preparing pancakes, eggs, toast or vegetables.
- Quickly reaches the indicated temperature. It guarantees a uniform cooking throughout the surface.
- Height regulation. 30 -minute power regulator and timer.
- Easy extraction (button) and plates placement to facilitate cleaning.
- Town collects fats. Non -slip base
- Includes spatula for cleaning the plates.

Professional use

A



B



- Plancha grill profesional con estructura de acero inoxidable y placas de hierro colado.
- Ideal para preparar carnes, pescados, verduras, bocadillos, etc.
- Placa superior (simple o doble) regulable en altura y abatible hasta 90°.
- Mango aislante térmico.

- Professional griddle with stainless steel structure and cast iron plates.
- Ideal for preparing meat, fish, vegetables, sandwiches, etc.
- Upper plate (single or double) adjustable in height and tiltable up to 90°.
- Thermal insulating handle.

Plancha Grill profesional

Grill · Grill
Grill · Grelhar

| | Ref | € | W | Temperatura | Medidas | U. Venta |
|---|-------|--------|------|-------------|-------------|----------|
| A | 69166 | 476,70 | 2200 | 50-300°C | 31x31x20 cm | 1 |
| B | 69167 | 744,00 | 4400 | 50-300°C | 57x31x20 cm | 1 |

Simple
Doble · Double



Sandwicheras



Household use

- Tuesta y sella 2 sándwiches al mismo tiempo y consigue resultados increíbles.
- Placas con revestimiento antiadherente de alta calidad y libres de PFOA.
- Asa termorresistente. Manipula la sandwichera con la máxima seguridad.
- Calentamiento rápido y uniforme. Indicadores led de encendido y calentamiento.
- Sistema de cierre y bloqueo sencillo y seguro.
- Compartimento para cable. Posibilidad de almacenamiento vertical.
- Patas de goma antideslizantes.

- Rôtis et sceller 2 sandwichs en même temps et obtenir des résultats incroyables.
- Plaques de haute qualité et antitens libres de PFOA.
- Poignée résistante au thermor. Manipule le sandwichera avec une sécurité maximale.
- Réchauffement rapide et uniforme. Indicateurs LED d'allumage et de chauffage.
- Système de fermeture et de blocage simple et sûre.
- Possibilité de stockage vertical.
- Pignes en caoutchouc non glissantes.

- Roasts and seal 2 sandwiches at the same time and get incredible results.
- High quality and free antiating plates of PFOA.
- Thermor resistant handle. Manipulates the sandwichera with maximum security.
- Fast and uniform warming. LED indicators of ignition and heating.
- Simple and safe closing and blocking system.
- Cable compartment. Possibility of vertical storage.
- Non -slip rubber legs.



Sandwichera Black

Appareil à sandwichs · Sandwichmaker
Sandwich toaster · Sanduicheira

| Ref | € | W | Medidas placa | Medidas | U.Venta |
|----------------|--------------|-----|---------------|-------------|----------------------|
| A 69147 | 31,60 | 750 | 10,5x12,5 cm | 25x24x11 cm | 1 Rectangular |
| B 69148 | 31,60 | 750 | 10,5x12,5 cm | 25x24x11 cm | 1 Triangular |

Sandwichera White

Appareil à sandwichs · Sandwichmaker
Sandwich toaster · Sanduicheira

| Ref | € | W | Medidas placa | Medidas | U.Venta |
|-------|--------------|-----|---------------|--------------|---------|
| 69247 | 36,00 | 750 | 11x11 cm | 23x22x8,5 cm | 1 |



Gofreras

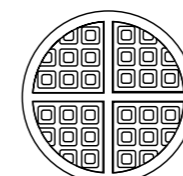

Ø18 cm del gofre
Waffle Ø18 cm

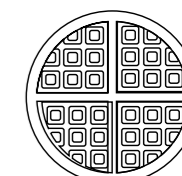

Gofre: Ø20 cm
Waffle: Ø20 cm



Placas en hierro colado
Cast iron plates



INOX 18/10 AL FUNDIDO
Aluminium Cast

Gofrera Pro

Gaufrier · Wendewaffeleisen
Waffle maker · Maquina de fazer gofres

| Ref | € | W | Temperatura | Placa gofre | Medidas | U.Venta |
|-------|---------------|------|-------------|-------------|-------------|---------|
| 69349 | 311,50 | 1000 | 50-300°C | Ø18 cm | 26x44x26 cm | 1 |

AL FUNDIDO
Aluminium Cast

Gofrera Reversible

Gaufrier réversible · Wendewaffeleisen
Waffle maker · Maquina de fazer gofres reversível

| Ref | € | W | Placa gofre | Medidas | U.Venta |
|-------|--------------|-----|-------------|-------------|---------|
| 69149 | 58,70 | 875 | Ø 20 cm | 34x24x15 cm | 1 |

Quemador



- Quemador de azúcar eléctrico redondo con soporte.
- Diseñado para aplicaciones en cocina y repostería profesional.
- Ideal para caramelizar crema.
- Se calienta muy rápido.
- Incluye soporte.

- Brûleur de sucre électrique rond avec soutien.
- Conçu pour les applications dans une cuisine professionnelle et des pâtisseries.
- Idéal pour caraméliser la crème.
- Il se réchauffe très vite.
- Comprend le support.

- Round electric sugar burner with support.
- Designed for applications in professional kitchen and pastries.
- Ideal to caramelize cream.
- It heats up very fast.
- Includes support.

Quemador eléctrico redondo

Fer à caraméliser électrique rond · Karamellisierer rund
Round electric caramelizer · Queimador eléctrico redondo

| Ref | € | W | Ø (cm) | U.Venta |
|-------|---------------|------|--------|---------|
| 68651 | 117,80 | 650 | Ø10 | 1 |
| 68652 | 136,00 | 1000 | Ø12 | 1 |



Incluye soporte
Includes support



Creperas



- Crea crepes dulces y salados, pancakes y tortitas de una manera sencilla y cómoda.
- Rapidez, potencia y un calentamiento uniforme.
- Placa de aluminio antiadherente de Ø30 cm, perfecta para hacer crepes de gran tamaño.
- Incluye rastrillo de madera para extender la masa y conseguir un grosor homogéneo y espátula para voltear el crepe.

- Créez des crêpes, des crêpes et des crêpes sucrées et salées de manière simple et confortable.
- Vitesse, puissance et réchauffement uniforme.
- Assiette en aluminium antiférent de Ø30 cm, parfaite pour les grandes crêpes.
- Comprend le râteau en bois pour répandre la pâte et obtenir une épaisseur homogène et une spatule pour tourner la crêpe.

- Create sweet and salty crepes, pancakes and pancakes in a simple and comfortable way.
- Speed, power and uniform warming.
- Antiferent aluminum plate of Ø30 cm, perfect for large crepes.
- Includes wood rake to spread the dough and get a homogeneous thickness and spatula to turn the crepe.

Placa de aluminio antiadherente de Ø40 cm
Non-stick aluminium plate Ø40 cm



Placa crepera Pro
Plaque crêpière · Crêpes-Kochplatte
Crepe maker · Placa crepeira

| Ref | € | W | Superficie placa | Medidas | U.Venta |
|-------|--------|------|------------------|---------------|---------|
| 69196 | 502,60 | 3000 | Ø 35 cm | 45x49x22,5 cm | 1 |

Placa de aluminio antiadherente de Ø33 cm
Non-stick aluminium plate Ø33 cm



Crepera TitanPro
Crêpière · Crêpesplatte
Crepe maker · Crepeira

| Ref | € | W | Superficie placa | Medidas | U.Venta |
|-------|-------|------|------------------|----------|---------|
| 69433 | 81,40 | 1500 | Ø33 | Ø33x7 cm | 1 |

Placa de aluminio antiadherente de Ø30 cm
Non-stick aluminium plate Ø30 cm



Crepera Black
Crêpière · Crêpesplatte
Crepe maker · Crepeira

| Ref | € | W | Superficie placa | Medidas | U.Venta |
|-------|-------|------|------------------|-------------|---------|
| 69122 | 56,60 | 1000 | Ø 30 cm | 40x36x11 cm | 1 |

Baño maría chocolate



Baño maría chocolate Black

Bain marie de chocolat · Bain Marie topf für Schokolade
Chocolate bain marie · Banho-maria chocolate

| Ref | € | W | L | Temperatura | Medidas | U.Venta |
|-------|-------|----|-----|-------------|-----------------|---------|
| 69317 | 42,80 | 50 | 1,0 | 40-50°C | 29 x 22 x 12 cm | 1 |

- Recipiente eléctrico con cazo desmontable de acero inoxidable de gran calidad.
- Dos funciones: fundir el chocolate (40-50°C) y mantenerlo caliente.
- Botón giratorio con 3 posiciones: apagar, fundir y calentar.
- Mantiene la temperatura constante a 40 - 50 grados.

- Récipient électrique avec acier inoxydable amovible en acier inoxydable de haute qualité.
- Deux fonctions: Faire fondre le chocolat (40-50°C) et le garder chaud.
- Bouton rotatif avec 3 positions: éteignez, faites fondre et chauffez.
- Maintenir la température constante à 40 à 50 degrés.

- Electric container with removable stainless steel of high quality stainless steel.
- Two functions: melt the chocolate (40-50°C) and keep it hot.
- Rotating button with 3 positions: turn off, melt and heat.
- Maintain the constant temperature at 40 - 50 degrees.



- Perfecta para elaborar coberturas de alta calidad y mantenerlas a la temperatura deseada durante horas.
- Ideal para la obtención de un glaseado brillante para pasteles, tartas, cake pops, muffins, etc.
- Contenedor GN1/6 (1,50L) y tapa extraíble de acero inoxidable 18/10 para garantizar una rápida y efectiva limpieza (aptos para el lavavajillas).
- Regulación de temperatura por termostato de 0°C a 60°C.
- Calentamiento 3D; el calor se distribuye de manera uniforme por toda la superficie del recipiente.
- Luz indicadora, se enciende tan pronto como se alcanza la temperatura deseada.
- Compatible con cubetas GN1/6 de Lacor

- Perfect to prepare high quality coverage and keep them at the desired temperature for hours.
- Ideal for obtaining a brilliant glaze for cakes, cakes, cake pops, muffins, etc.
- GN1/6 (1.50L) container and removable stainless steel cover 18/10 to guarantee rapid and effective cleaning (suitable for dishwasher).
- Temperature regulation by thermostat from 0°C to 60°C.
- 3D heating; The heat is distributed uniformly throughout the surface of the container.
- Indicator light, comes as soon as the desired temperature is reached.
- Compatible with Gn1/6 buckets from Lacor



Baño maría chocolate White

Bain marie de chocolat · Bain Marie topf für Schokolade
Chocolate bain marie · Banho-maria chocolate

| Ref | € | W | L | Temperatura | Medidas | U.Venta |
|-------|-------|----|-----|-------------|-----------------|---------|
| 69617 | 77,60 | 80 | 1,5 | 60°C | 22,6x26x14,3 cm | 1 |



Fondue

INOX 18/10 CE  Household use



- Fondue eléctrica acabada en acero inoxidable de gran calidad. 1500W de potencia.
- Ideal para fundir queso, chocolate o calentar aceite.
- Olla de acero inoxidable desmontable y de 1,2 L de capacidad con fondo termodifusor para una distribución uniforme del calor.
- Termostato regulable para calentar y mantener los ingredientes siempre calientes.
- Protector antisalpicaduras extraíble con soporte para 8 tenedores.
- Incluye 8 tenedores de acero inoxidable y marcas de colores.
- Apagado de seguridad contra sobrecalentamiento.
- Pies antideslizantes. 100% estable.
- Olla, protector y tenedores aptos para el lavavajillas.

- High quality stainless steel electric fondue set. 1500 W power.
- Ideal for melting cheese, chocolate or heating oil.
- 1.2 L removable stainless steel pot with thermo-diffuser bottom for even heat distribution.
- Adjustable thermostat to heat and keep the ingredients hot at all times.
- Removable splash guard lid that holds 8 forks.
- Includes 8 stainless steel colour marked forks.
- Overheating safety function.
- Non-slip feet. 100% stable.
- Dishwasher safe pot, lid and forks.



Fondue Grey Plus
Fondue · Fondue
Fondue · Fonduel

| Ref | € | W | Temperatura | L | Medidas | U.Venta |
|-------|--------|------|-------------|------|-----------------|---------|
| 69399 | 101,90 | 1500 | 40°C - 95°C | 1,20 | 29,5x21x24,5 cm | 1 |

Chocolatera

INOX CE  Professional use



- Chocolatera profesional diseñada para mezclar y calentar chocolate al baño maría.
- Cubeta de policarbonato de 5 litros de capacidad.
- Termostato regulable de 0°C a 90°C.
- Sensor para prevenir posibles sobrecalentamientos.
- Sistema NonStop: movimiento continuo para conseguir resultados sin grumos y de consistencia perfecta.
- Grifo con sistema antigoteo y antiobstrucción, totalmente desmontable.
- Ideal para bares, restaurantes, cafeterías, hoteles, catering, foodtrucks, etc.
- Bandeja antigoteo con sistema de aviso.
- Base antideslizante. Fácil limpieza.

- Professional chocolatera designed to mix and heat chocolate in the water bath.
- 5 -liter capacity polycarbonate bucket.
- Adjustable thermostat from 0°C to 90°C.
- Sensor to prevent possible overheating.
- Nonstop System: Continuous movement to achieve results without lumps and perfect consistency.
- Tap with anti -tote and anti -obstruction system, totally removable.
- Ideal for bars, restaurants, coffee shops, hotels, catering, foodtrucks, etc.
- Anti -tote tray with warning system.
- Non -slip base Easy cleaning.



Chocolatera Chocosweet
Chocolatière · Schokoladenkocher
Chocolate machine · Chocolateira

| Ref | € | W | L | Medidas | U.Venta |
|-------|--------|------|-----|--------------|---------|
| 69615 | 862,90 | 1000 | 5,0 | 28x41x46,5cm | 1 |

Fuentes chocolate

INOX 18/10 CE  Semiprofessional use



Fuentes Chocolate
Fontaine chocolat · Schokoladen Fontäne
Chocolate fountain · Fonte chocolate

| Ref | € | W | Temperatura | Capacidad | Medidas | U.Venta |
|---------|--------|----|-------------|-----------|-----------------|---------|
| A 69318 | 61,70 | 35 | 40°C -50°C | 0,5L | 16,5x16,5x31 cm | 1 |
| B 69319 | 105,00 | 80 | 40°C -50°C | 1,8L | 23x23x56cm | 1 |

- Fabricada en acero inoxidable 18/10 de gran calidad.
- Crea una cascada de chocolate fundido y lo mantiene caliente para bañar alimentos.
- Ideal para buffet, hoteles, restaurantes, estas y celebraciones.
- Torre de 18 cm de tres niveles.
- Interruptor de calentamiento independiente.
- Base con apoyos antideslizantes.
- Desmontable.

- Fabriqué en acier inoxydable 18/10 de haute qualité.
- Créez une cascade de chocolat coulée et gardez-la chaude pour baigner les aliments.
- Idéal pour le buffet, les hôtels, les restaurants, ceux-ci et les célébrations.
- Tour de 18 cm de trois niveaux.
- Interrupteur de chauffage indépendant.
- Base avec support non glissé.
- Amovible.

- Made of stainless steel 18/10 of high quality.
- Create a cast chocolate cascade and keep it hot to bathe food.
- Ideal for buffet, hotels, restaurants, these and celebrations.
- 18 cm tower of three levels.
- Independent heating switch.
- Base with non -slip support.
- Removable.

Aerógrafo

INOX CE  Professional use



Aerógrafo con compresor
Aérographe avec compresseur · Airbrush Spritzpistole mit Kompressor
Airbrush with compressor · Aerógrafo com compressor

| Ref | € | W | Presión | Caudal | Capacidad | U.Venta |
|-------|--------|----|-----------|--------------|-----------|---------|
| 69450 | 103,20 | 20 | 0 - 2 bar | 0 - 10 L/min | 7ml | 1 |

- Soporte**
Soporte para aerógrafo de 360° para un uso práctico
360° airbrush stand for practical use
- Regulador de aire**
Aumenta y disminuye el caudal de salida
Increase and decrease the output flow
- Ampolla de recarga Llave**
Ampolla: recarga de pintura Llave; monta/desmonta la boquilla
Flask, paint refill
Spanner, assemble/disassemble the nozzle
- Aerógrafo**
Genera un fino chorro de pintura para recubrir superficies o realizar dibujos mediante la palanca
Deposito de 7 ml
Creates a fine spray of paint for covering surfaces or making drawings by lever
7 ml tank
- Tubo conector (1,8 m)**
Manguera textil flexible con dos conexiones que traslada el aire del compresor al aerógrafo
Flexible cloth hose with two connections that carries air from the compressor to the airbrush



Chafing Dish eléctrico

INOX CE  Professional use

- Ideal para el sector de la hostelería, restauración y catering.
- Mantiene la temperatura de los alimentos.
- Más seguro al carecer de llama de los geles.
- Tapa y cubeta extraíble GN 1/1 h=65 mm (8,50 L) fabricados en acero inoxidable de alta calidad. Cuerpo fabricado en polipropileno.
- Termostato regulable (85°C +/-10°C).
- Interruptor de encendido y apagado. Indicador luminoso.
- Protección contra sobrecalentamiento.
- Fácil de transportar gracias a sus asas laterales.
- 6 pies antideslizantes y resistentes para mantener la estabilidad.

- Idéal pour le secteur de l'hospitalité, de la restauration et de la restauration.
- Gardez la température alimentaire.
- Plus sûr, sans la flamme des gels.
- Couvercle amovible et cuvette GN 1/1 h = 65 mm (8,50 L) fabriqués en acier inoxydable de haute qualité. Corps fabriqué en polypropylène.
- Thermostat réglable (85 ° C +/- 10 ° C).
- Affonter et désactiver. Indicateur lumineux.
- Protection de surchauffe.
- Facile à transporter grâce à vos poignées latérales.
- 6 Pieds non glissants et résistants pour maintenir l'établissement.

- Ideal for the hospitality, restoration and catering sector.
- Keep the food temperature.
- Safer lacking the flame of the gels.
- Removable lid and cuvette Gn 1/1 h = 65 mm (8.50 l) Manufactured in high quality stainless steel. Body manufactured in polypropylene.
- Adjustable thermostat (85 ° C +/- 10 ° C).
- Switch on and off. Luminous indicator.
- Overheating protection.
- Easy to transport thanks to your lateral handles.
- 6 non -slip and resistant feet to maintain the establishment.



Chafing Dish eléctrico

Chafing dish électrique · Elektrische Chafing Dish
Electric chafing dish · Chafing dish eléctrico

| Ref | € | W | L | U.Venta |
|-------|--------|-----|-------|---------|
| 69336 | 183,00 | 900 | 8,5 L | 1 |

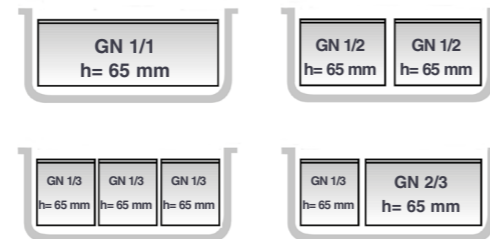

Calentadores para chafing dish

Corp de chauffe pour bain marie · Heizung für chafing dish
Heating unit for chafing dish · Aquecedor para chafing dish

| Ref | € | W | Temperatura | U.Venta |
|---------|--------|-----|-------------|---------|
| A 69002 | 190,70 | 700 | 96°C(máx) | 1 |
| B 69012 | 220,60 | 700 | 92°C(máx) | 1 |

Olla calentadora sopa Profesional

CE  Professional use

- Mantiene caliente todo tipo de sopas, salsas, consomés y líquidos.
- Ideal para cantidades grandes.
- Control de temperatura regulable por termostato.
- Cubeta interior desmontable.
- Alta resistencia y durabilidad.

- Maintenir au chaud tout type de soupes, sauces, consommés, liquides, etc.
- Idéal pour de grandes quantités.
- Contrôle de la température réglable par thermostat.
- Seau intérieur amovible.
- Haute résistance et durabilité.

- Keep all kinds of soups, sauces, consommés, liquids etc hot.
- Ideal for large amounts.
- Temperature control adjustable by thermostat.
- Removable inner bucket.
- High resistance and durability.



Olla calentadora sopa Profesional

Marmite Buffet chaud · Suppen-und Speisenwärmer
Soup kettle · Panela aquecedora de sopa

| Ref | € | W | Temperatura | Capacidad | Medidas | U.Venta |
|---------|--------|-------------|-------------|-----------|---------------|-------------------|
| A 69267 | 297,80 | 800 W | 30°C-90°C | 10L | Ø33x32 cm | 1Inox 18/10 |
| B 69037 | 178,70 | 400 - 475 W | 30°C-90°C | 11L | Ø34,5 x 36 cm | 1Hierro esmaltado |
| C 69038 | 251,90 | 400 - 475 W | 30°C-90°C | 10L | Ø34,5x36 cm | 1Inox |



Repuesto recipiente (69037-69038)

Réceptier de rechange (69037-69038) · Ersatzbehälter (69037-69038)
Spare container (69037-69038) · Recipiente de reserva (69037-69038)

| Ref | € | L | U.Venta |
|-------|-------|----|---------|
| 69039 | 59,70 | 10 | 1 |

Calentador biberones

INOX    Professional use

- Fabricada en acero inoxidable de alta calidad con aislamiento térmico.
- Sistema de calentamiento en seco y homogéneo.
- Permite mantener calientes las preparaciones previamente elaboradas.
- Cómodo y fácil de usar.
- Termostato regulable de temperatura independiente.
- Incluye 2 botellas de 550 ml de capacidad con 3 boquillas dispensadoras.
- Compatible con nuestras botellas biberón (Ref.: 61974-61977).

- Fabriqué en acier inoxydable de haute qualité avec isolation thermique.
- Système de chauffage sec et homogène.
- Il vous permet de garder les préparatifs précédemment préparés.
- Pratique et facile à utiliser.
- Thermostat à température indépendante réglable.
- Comprend 2 bouteilles de 550 ml de capacité avec 3 buses de distribution.
- Compatible avec nos bouteilles de bouteille (Réf.: 61974-61977).

- Made of high quality stainless steel with thermal insulation.
- Dry and homogeneous heating system.
- It allows you to keep the preparations previously prepared.
- Convenient and easy to use.
- Adjustable independent temperature thermostat.
- Includes 2 bottles of 550 ml capacity with 3 dispensing nozzles.
- Compatible with our bottle bottles (Ref.: 61974-61977).



Calentador biberones

Chauffe-sauces · Flaschenwärmer
Squeeze bottle warmer · Aquecedor de garrafas dispensadoras

| Ref | € | W | Capacidad | Temperatura | Medidas | U.Venta |
|-------|--------|-----|-----------|-------------|---------------|---------|
| 69242 | 251,60 | 160 | 550ml x 2 | 60-80°C | 30,5x25x23 cm | 1 |

Baño María GN 1/1 Profesional

INOX 18/10   Professional use

Combinaciones de cubetas posibles
Possible tray options

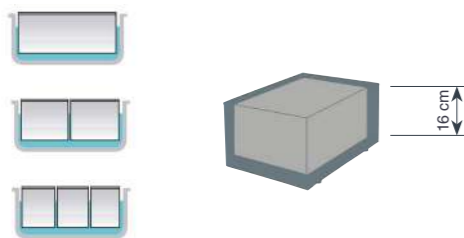

Baño María GN 1/1 Profesional

Bain-marie en inox GN 1/1 150 mm · Bain Marie, GN 1/1 150 mm, Rostfrei
St. steel bain-marie GN 1/1 150 mm · Banho-maria GN 1/1 150 mm

| Ref | € | W | L | Temperatura | Medidas | U.Venta |
|-------|--------|------|------|-------------|---------------|---------|
| 69036 | 239,90 | 1300 | 24,0 | 30-85°C | 61,5x29x30 cm | 1 |

Placas calentamiento

INOX 18/10   Professional use

- Una solución perfecta para profesionales de la hostelería, buffet, eventos, catering, ferias, etc.
- Ideal para mantener los alimentos calientes antes de servirlos en la mesa a la temperatura perfecta.
- Termostato regulable en temperatura.
- Atención: NO cocinar sobre la misma placa.

- Une solution parfaite pour l'hospitalité, les professionnels du buffet, les événements, la restauration, les foires, etc.
- Idéal pour garder les aliments chauds avant de les servir à la table à la température parfaite.
- Thermostat réglable à température.
- ATTENTION: Ne cuisinez pas dans la même assiette.

- A perfect solution for hospitality, buffet professionals, events, catering, fairs, etc.
- Ideal to keep hot food before serving them at the table at the perfect temperature.
- Adjustable thermostat in temperature.
- Attention: Do not cook on the same plate.



Calentador Buffet 3xGN 1/3

Chauffe · Warmer
Warmer · Aquecedor

| Ref | € | W | Superficie placa | Contenedor | Medidas | U. Venta |
|-------|--------|-----|------------------|-------------|---------------|----------|
| 69445 | 102,40 | 300 | 53x36 cm | GN 1/3 (x3) | 65x38x15,5 cm | 1 |

Placa calentamiento

Plaque pour Chauffante · Warmhalteplatte
Warming Plate · Placa aquecimiento

| Ref | € | W | Superficie placa | Medidas | U. Venta |
|-------|-------|-----|------------------|--------------|----------|
| 69045 | 95,00 | 300 | 53x36 cm | 65x38x6,2 cm | 1 |



Placa calentamiento Vitrocerámica

Plaque vitrocéramique chaleur · Glaskeramikeizplatte
Hob heating plate · Placa aquecimiento vitrocerámica

| Ref | € | W | Superficie placa | Temperatura | U. Venta |
|-------|--------|-----|------------------|-------------|----------|
| 69145 | 210,30 | 230 | 55x36,5 cm | 60-105°C | 1 |



Placa calentamiento Vitro Slim

Plaque vitrocéramique chaleur · Glaskeramikeizplatte
Hob heating plate · Placa aquecimiento vitrocerámica

| Ref | € | W | Superficie placa | Temperatura | U. Venta |
|-------|--------|-----|------------------|-------------|----------|
| 69446 | 104,10 | 230 | 38x45 cm | 60-105°C | 1 |

Calentador Buffet

INOX   Professional use

- Mantiene los platos a temperatura perfecta durante un tiempo prolongado.
- Estructura de acero inoxidable de alta calidad y resistente.
- Placa calentadora de acero inoxidable con regulación de temperatura entre 40°C - 90°C.
- Lámparas halógenas para garantizar una temperatura homogénea con regulación independiente para cada una de ellas.
- Gardez la vaisselle à température parfaite pendant longtemps.
- Structure en acier inoxydable de haute qualité et résistante.
- Réfonce en acier inoxydable avec régulation de la température entre 40 ° C à 90 ° C.
- Lampes halogènes pour garantir une température homogène avec une régulation indépendante pour chacun d'eux.
- Keep the dishes at perfect temperature for a long time.
- High quality and resistant stainless steel structure.
- Stainless steel heater with temperature regulation between 40°C - 90°C.
- Halogen lamps to guarantee a homogeneous temperature with independent regulation for each of them.
- Highly resistant plexiglass protective screen.

A Dual



B Triple



Calentador Buffet

Plaque électrique · Warmhalteplatte
Electric warming plate · Placa aquecimento elétrico

| Ref | € | W (placa) | W (lámpara) | Superficie placa | Medidas | U. Venta |
|----------------|---------------|-----------|-------------|------------------|--------------|----------|
| A 69562 | 533,40 | 500 | 2x250W | 71x50 cm | 78x53x70 cm | 1 |
| B 69563 | 702,80 | 650 | 3x250W | 99x50 cm | 107x53x70 cm | 1 |



Incluye bombillas infrarrojos (Ref.: R69061A)
Includes infrared heating bulbs

Lámparas de calentamiento extensibles

AL   Professional use

- Para uso profesional en hostelería.
- Mantiene calientes los platos.
- Calentamiento por infrarrojos.
- Se aconseja mantener la lámpara a 50 - 60 cm de distancia de los platos.
- Incluye bombilla para todas nuestras lámparas de calentamiento.
- Pour un usage professionnel dans la restauration.
- Maintient les plats au chaud.
- Chauffage infrarouge.
- Il est conseillé d'éloigner la lampe de 50 à 60 cm de distance de la vaisselle.
- Comprend une ampoule pour toutes nos lampes chauffantes.
- For professional catering use.
- Keeps the dishes warm.
- Infrared heating.
- It is recommended that the lamp is kept at a distance of 50-60cm from the plates.
- Bulb for all our heating lamps.



Lámpara calentamiento infrarrojos

  Professional use



AL
Aluminium

INOX
18/10

Lámpara calentamiento infrarrojos

Lampe de chauffage infrarouge · Infrarot Wärmelampe
Infrared heating lamp · Lampara calor infravermelho

Lámpara calentamiento infrarrojos Inox

Lampe de chauffage infrarouge · Infrarot Wärmelampe
Infrared heating lamp · Lampara calor infravermelho

| Ref | € | W | Medidas | h(cm) | U. Venta |
|----------------|---------------|-----|---------|-------|----------|
| A 69361 | 108,00 | 275 | 34x33cm | 71 | 1 |
| B 69061 | 149,40 | 550 | 36x45cm | 75 | 1 |

| Ref | € | W | Medidas | h(cm) | U. Venta |
|----------------|---------------|-----|---------|-------|----------|
| C 69263 | 486,40 | 275 | 31x23cm | 79 | 1 |
| D 69264 | 632,30 | 550 | 36x36cm | 76 | 1 |

Bombilla infrarrojos

Ampoule infrarouge · Infrarot Glühbirne
Infrared heating bulb · Lampada infravermelho

| Ref | € | W | U. Venta |
|---------|--------------|-----|----------|
| R69061A | 10,10 | 275 | 1 |



Lámparas de calentamiento extensibles

Lampe de chauffage câble extensible · Infrarot Wärmelampe Kabel ausziehbar
Infrared heating lamp extensible · Lámpara calor infravermelho cabo extensível

| Ref | € | W | U. Venta | Color |
|----------------|---------------|-----|----------|------------------|
| A 69266 | 130,20 | 275 | 1 | Lijado · Sanding |
| B 69365 | 149,60 | 275 | 1 | Cromado · Chrome |
| C 69367 | 149,60 | 275 | 1 | Cobre · Copper |
| D 69359 | 141,20 | 275 | 1 | Negra · Black |

Lámparas de calentamiento extensibles cónica

Lampe chauffante extensible conique · Wärmelampe Kabel ausziehbar, konisch
Conical heating lamp extensible · Lampada de aquecimento ext. cônica

| Ref | € | W | U. Venta | Color |
|----------------|---------------|-----|----------|------------------|
| E 69564 | 134,80 | 275 | 1 | Lijado · Sanding |
| F 69566 | 161,80 | 275 | 1 | Cromado · Chrome |
| G 69565 | 164,60 | 275 | 1 | Cobre · Copper |
| H 69576 | 151,00 | 275 | 1 | Negra · Black |

Vitrinas

CE  Professional use



- Vitrina neutra construida íntegramente en cristal y base de acero inoxidable.
- Diseñada para presentar y exponer sobre la barra / mostrador.
- Superficie superior curvada para una visión panorámica.
- Estante intermedio de cristal templado.
- Puerta trasera abatible.
- 4 pies de goma que garantizan máxima estabilidad.

- Vitrine neutre construite entièrement dans une base en verre et en acier inoxydable.
- Conçu pour présenter et exposer sur la barre / comptoir.
- Surface supérieure incurvée pour une vue panoramique.
- Étagère en verre trempé intermédiaire.
- Porte arrière pliante.
- 4 pieds en caoutchouc qui garantissent une stabilité maximale.

- Neutral showcase built entirely in glass and stainless steel base.
- Designed to present and expose on the bar / counter.
- Curved upper surface for a panoramic view.
- Intermediate tempered glass shelf.
- Folding rear door.
- 4 rubber feet that guarantee maximum stability.

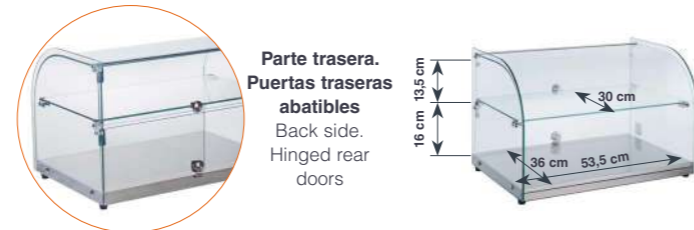

Parte trasera. Puertas traseras abatibles. Back side. Hinged rear doors

CRISTAL INOX
Glass

Vitrina neutra

Vitrine neutre · Einfache vitrine
Clear countertop display case · Vitrina neutra

| Ref | € | Capacidad | h(cm) | Medidas | U.Venta |
|-------|--------|-----------|-------|---------------|---------|
| 69601 | 293,10 | 45L | 37 | 56x37,6x37 cm | 1 |



IPX4

- Vitrina térmica fabricada en acero inoxidable y cristal.
- Diseñada para conservar, presentar y exponer sobre la barra / mostrador.
- Puerta trasera abatible.
- Superficie superior inclinada para una visión panorámica.
- Recipiente de agua extraíble que aporta humedad en la cámara.
- Termostato de control de temperatura regulable: 30-90°C.
- Bandeja de rejilla extraíble que facilita el lujo del calor.

- Vitrine thermique fabriquée en acier inoxydable et en verre.
- Conçu pour conserver, présenter et exposer sur la barre / comptoir.
- Porte arrière pliante.
- Supérieur submergé pour une vue panoramique.
- Récipient d'eau amovible qui apporte l'humidité dans la chambre.
- Thermostat de commande de température réglable: 30-90°C.
- Plateau de grille amovible qui facilite le luxe de la chaleur.

- Thermal showcase manufactured in stainless steel and glass.
- Designed to conserve, present and expose on the bar / counter.
- Folding rear door.
- Superior overwhelmed for a panoramic view.
- Removable water container that brings moisture in the chamber.
- Adjustable temperature control thermostat: 30-90°C.
- Removable grid tray that facilitates the luxury of heat.



Parte trasera. Puertas traseras abatibles. Back side. Hinged rear doors

CRISTAL INOX
Glass

Vitrina térmica

Vitrine thermique · Warmhaltevitrine
Thermal display case · Vitrina térmica

| Ref | € | W | Capacidad | Temperatura | Protección | Medidas | U.Venta |
|-------|--------|-----|-----------|-------------|------------|-----------------|---------|
| 69604 | 592,80 | 800 | 45L | 30°C-90°C | IPX4 | 55,5x37,5x37 cm | 1 |

520



4
Cubetas
Containers



6
Cubetas
Containers

CRISTAL INOX
Glass

Vitrina térmica con cubetas

Vitrine thermique · Warmhaltevitrine
Thermal display case · Vitrina térmica

| Ref | € | W | Capacidad | Temperatura | Protección | Medidas | U.Venta |
|---------|--------|-----|-----------|-------------|------------|-----------------|---------|
| A 69602 | 653,60 | 500 | 4x GN 1/3 | 30°C-90°C | IPX4 | 77,5x42x33,5 cm | 1 |
| B 69603 | 751,40 | 800 | 6x GN 1/3 | 30°C-90°C | IPX4 | 113x42x33,5 cm | 1 |



Parte trasera. Puertas traseras abatibles. Back side. Hinged rear doors. 4/6 cubetas gastronorm 1/3 incluidas. 4/6 Gastronorm 1/3 trays included

IPX4

- Vitrina refrigerada construida íntegramente en cristal y acero inoxidable.
- Diseñada para conservar, presentar y exponer sobre la barra / mostrador.
- Puertas correderas para una accesibilidad total.
- Superficie superior inclinada para una visión panorámica.
- Sistema de enfriamiento por compresor. Función Defrost.
- Termostato de control de temperatura regulable: 2-12°C.
- Sist. de iluminación LED en la cámara interior y display de control de mandos.

- Vitrine réfrigérée construite entièrement en verre et en acier inoxydable.
- Conçu pour conserver, présenter et exposer sur la barre / comptoir.
- Portes coulissantes pour l'accessibilité totale.
- Surface supérieure inclinée pour une vue panoramique.
- Système de refroidissement du compresseur. Fonction de dégivrage.
- Thermostat de commande de température réglable: 2-12°C.
- Sist. d'éclairage LED dans la chambre intérieure et le contrôle des commandes.

- Refrigerated showcase built entirely in glass and stainless steel.
- Designed to conserve, present and expose on the bar / counter.
- Sliding doors for total accessibility.
- Inclined upper surface for a panoramic view.
- Compressor cooling system. Defrost function.
- Adjustable temperature control thermostat: 2-12°C.
- Sist. of LED lighting in the inner chamber and control of controls.



Parte trasera. Back side

CRISTAL INOX
Glass

Vitrina refrigerada

Vitrine réfrigérée · Kühlvitrine
Refrigerated display case · Vitrina refrigerada

| Ref | € | W | Capacidad | Temperatura | Refrigerante | Medidas | U.Venta |
|-------|---------|-----|-----------|-------------|--------------|-------------|---------|
| 69607 | 1113,60 | 105 | 40L | 2-12°C | R600a | 68x58x34 cm | 1 |

521



4
Cubetas
Containers



6
Cubetas
Containers

- Vitrina refrigerada construida íntegramente en cristal y acero inoxidable.
- Diseñada para conservar, presentar y exponer sobre la barra / mostrador.
- Puertas correderas para una accesibilidad total.
- Superficie superior curvada para una visión panorámica.
- Sistema de enfriamiento por compresor.
- Cubetas gastronorm 1/3 incluidas.
- Termostato de control de temperatura regulable: 0-12°C.
- Sistema de iluminación LED en la cámara interior y display de control de mandos.

- Vitrine réfrigérée construite entièrement en verre et en acier inoxydable.
- Conçu pour conserver, présenter et exposer sur la barre / comptoir.
- Portes coulissantes pour l'accessibilité totale.
- Surface supérieure incurvée pour une vue panoramique.
- Système de refroidissement du compresseur.
- Cubetas Gastronorm 1/3 inclus.
- Thermostat de commande de température réglable: 0-12°C.
- Système d'éclairage LED dans l'écran de commande de la chambre intérieure et de la commande.

- Refrigerated showcase built entirely in glass and stainless steel.
- Designed to conserve, present and expose on the bar / counter.
- Sliding doors for total accessibility.
- Curved upper surface for a panoramic view.
- Compressor cooling system.
- Gastronorm 1/3 trays included.
- Adjustable temperature control thermostat: 0-12°C.
- LED lighting system in the inner chamber and control control display.



Control de temperatura regulable
Temperature control thermostat

Puertas traseras correderas
Sliding rear doors

INOX CRISTAL Glass

Vitrina refrigerada con cubetas
Vitrine réfrigérée · Kühlvitrine
Refrigerated display case · Vitrina refrigerada

| Ref | € | W | Capacidad | Temperatura | Refrigerante | Medidas | U.Venta |
|---------|---------|-----|-----------|-------------|--------------|----------------|---------|
| A 69605 | 1270,50 | 160 | 4x GN 1/3 | 0°C-12°C | R600a | 112,1x45x33 cm | 1 |
| B 69606 | 1408,60 | 160 | 6x GN 1/3 | 0°C-12°C | R600a | 148,3x45x33 cm | 1 |

69602

Combinaciones posibles
Possible combinations

| | |
|--------|--------|
| GN 2/3 | GN 2/3 |
|--------|--------|

| | | | |
|--------|--------|--------|--------|
| GN 1/3 | GN 1/3 | GN 1/3 | GN 1/3 |
|--------|--------|--------|--------|

69603

Combinaciones posibles
Possible combinations

| | | |
|--------|--------|--------|
| GN 2/3 | GN 2/3 | GN 2/3 |
|--------|--------|--------|

| | | | |
|--------|--------|--------|--------|
| GN 1/2 | GN 1/2 | GN 1/2 | GN 1/2 |
|--------|--------|--------|--------|

| | | | | | |
|--------|--------|--------|--------|--------|--------|
| GN 1/3 | GN 1/3 | GN 1/3 | GN 1/3 | GN 1/3 | GN 1/3 |
|--------|--------|--------|--------|--------|--------|

Dispensador de agua caliente

INOX BPA free CE Household use



Dispensador de agua caliente

Distributeur d'eau chaude · Heißwasserspender
Hot water dispenser · Dispensador de água quente

| Ref | € | L | W | Niveles calentamiento | Medidas | U.Venta |
|-------|--------|-----|------|---------------------------|-------------|---------|
| 69298 | 127,90 | 2 L | 2400 | 25°C - 70°C - 85°C - 95°C | 32x17x33 cm | 1 |

Hervidores de Agua

CE BPA free Household use



Base independiente rotativa de 360°
Independent base rotates 360°



Interior inox 18/10
Interior 18/10 st. steel



Boquilla con filtro
Nozzle with filter



Interior inox 18/10.
Interior 18/10 st. steel.



INOX 18/10

Strix
Technology

Hervidor de agua Retro

Bouilloire électrique · Elektrische Wasserwamer
Electric kettle · Chaleira eléctrica

| Ref | € | W | Capacidad | Medidas | U.Venta |
|-------|-------|------|-----------|---------------------|---------|
| 69397 | 59,80 | 2200 | 1,7L | 26 x 19,5 x 26,5 cm | 1 |

CE
Ceramic

Hervidor de agua Gala

Bouilloire en céramique · Keramik Wasserwamer
Ceramic kettle · Chaleira cerâmica

| Ref | € | W | Capacidad | Medidas | U.Venta |
|-------|-------|------|-----------|-----------------|---------|
| 69276 | 53,10 | 1500 | 1,2L | 24 x 17 x 25 cm | 1 |



Hervidor de agua

Bouilloire · Wasserwamer
Kettle · Chaleira

| | Ref | € | W | Capacidad | Medidas | U.Venta |
|---|-------|-------|------|-----------|-------------|---------|
| A | 69591 | 23,20 | 2200 | 1,3 L | 20x15x21 cm | 1 |
| B | 69590 | 23,20 | 2200 | 1,3 L | 20x15x21 cm | 1 |

Strix
Technology



INOX
18/10

Hervidor de agua Lake

Bouilloire · Wasserwamer
Kettle · Chaleira

| | Ref | € | W | Capacidad | Medidas | U.Venta |
|--|-------|-------|------|-----------|-----------------|---------|
| | 69277 | 61,30 | 2200 | 1,7 L | 23 x 16 x 23 cm | 1 |



Fácil llenado
Easy filling



Visor de nivel de agua
Water level



Hervidor de agua Rapid

Bouilloire · Wasserwamer
Kettle · Chaleira

| | Ref | € | W | Capacidad | Medidas | U.Venta |
|--|-------|-------|------|-----------|-----------------|---------|
| | 69291 | 40,90 | 1630 | 1,0L | 22 x 16 x 21 cm | 1 |
| | 69297 | 51,10 | 2200 | 1,7L | 22 x 18 x 23 cm | 1 |



Protección de ebullición en seco
Dry boil protection



Temperatura ajustable de 50°C-95°C
Adjustable temperature from 50°C-95°C

CRISTAL
Glass

Hervidor de agua Vista

Bouilloire · Wasserwamer
Kettle · Chaleira

| | Ref | € | W | Capacidad | Temperatura | Medidas | U.Venta |
|--|-------|-------|------|-----------|-------------|-----------------|---------|
| | 69292 | 82,90 | 2200 | 1,7 L | 50-95°C | 23 x 23 x 32 cm | 1 |



50 -
95°C
max

Airpot

INOX CE Professional use



Airpot

Électrique Airpot · Elektrische Getrankenpender
Electric Airpot · Airpot eléctrico

| | Ref | € | W | Capacidad | Temperatura | Medidas | U.Venta |
|--|-------|--------|------|-----------|-------------|-------------|---------|
| | 69472 | 134,60 | 1500 | 4L | 60°C-100°C | 28x28x35 cm | 1 |
| | 69476 | 145,50 | 1500 | 6L | 60°C-100°C | 28x28x40 cm | 1 |
| | 69471 | 158,80 | 1500 | 10L | 60°C-100°C | 28x28x48 cm | 1 |

- Fabricado en acero inoxidable resistente y de alta calidad.
- Calienta y mantiene el agua a una temperatura óptima.
- Dispone de un grifo dispensador con indicador de nivel de líquido.
- Temperatura controlada por termostato con un rango de 60°C a 100°C. Sensor de temperatura en el interior.
- Dispone de asas laterales aislantes del calor para un desplazamiento seguro.
- Fácil sistema de apertura y nivel de indicador de líquido. Con marcas de llenado en su interior.
- Sistema de dispensado cómodo y bandeja de goteo.
- Nota: utilizar solamente con agua.

- Fabriqué en acier inoxydable résistant et de haute qualité.
- Chauffer et garder l'eau à une température optimale.
- Il a un robinet de distributeur avec un indicateur de niveau liquide.
- Température contrôlée par thermostat avec une plage de 60 ° C à 100 ° C. Capteur de température à l'intérieur.
- Il a des poignées latérales isolantes à la chaleur pour un déplacement sûr.
- Système d'ouverture facile et indicateur liquide. Avec des marques de remplissage à l'intérieur.
- Système de distribution confortable et plateau goutte à goutte.
- Remarque: utilisez uniquement avec de l'eau.

- Made of resistant and high quality stainless steel.
- Heat and keep the water at an optimal temperature.
- It has a dispenser tap with liquid level indicator.
- Thermostat controlled temperature with a range of 60°C to 100°C. Temperature sensor inside.
- It has heat-insulating side handles for safe displacement.
- Easy opening system and liquid indicator level. With filling marks inside.
- Comfortable dispensing system and drip tray.
- Note: Use only with water.

Cafetera Percoladora

INOX CE Professional use



Filtro microperforado
Micro-perforated filter



- Fabricada en acero inoxidable de gran calidad.
- Ideal para cafeterías, restaurantes, bares, servicios de buffet y estaciones self-service.
- 2 sistemas de calentamiento independientes para la función de infusión y la función de conservación del calor.
- Distribución de calor rápida y homogénea.
- Mantiene el café a la temperatura óptima salvaguardando sus propiedades de sabor y aroma durante horas.
- Filtro de malla microperforada de acero inoxidable, especialmente diseñado para evitar la generación de posos.
- Luz indicadora de preparación. Indicador del nivel de agua. Bandeja antigoteo.
- Tapa con cierre de seguridad mediante botón de bloqueo.
- Sistema de protección contra el calentamiento en vacío.
- Opción de lujo continuo para una máxima comodidad.
- Tapa, filtro y tubo percolador aptos para el lavavajillas.

- Made of high quality stainless steel.
- Ideal for coffee shops, restaurants, bars, buffet services and Self-Service stations.
- 2 independent heating systems for infusion function and heat conservation function.
- Fast and homogeneous heat distribution.
- Keep coffee at the optimal temperature safeguarding its flavor and aroma properties for hours.
- Stainless steel microperforated mesh filter, specially designed to prevent the generation of posos.
- Preparation indicator light. Water level indicator. Antigoteing tray.
- Safety closure cover using lock button.
- Vacuum warming protection system.
- Continuous luxury option for maximum comfort.
- Cover, filter and percolative tube suitable for dishwasher.

Cafetera Percoladora

Percolateur à café · Kaffee-Perkolator
Coffee percolator · Máquina/Percolador de café

| | Ref | € | W | Capacidad | Medidas | U.Venta |
|--|-------|--------|------|-----------|-------------|---------|
| | 69486 | 167,30 | 1500 | 6L | 28x28x40 cm | 1 |
| | 69481 | 186,70 | 1500 | 10L | 35x35x45 cm | 1 |

Molinillos

INOX BPA free Dishwasher CE  Household use



- Ideal para moler café y otros productos como semillas, hierbas, frutos secos, cereales, sal, pimienta o especias.
- 100% acero inoxidable: cuerpo y cuchillas fabricados en acero inoxidable de máxima calidad.
- Tapa transparente: tapa superior de color transparente para visualizar el grano molido.
- Interruptor ON/OFF: funcionamiento con un simple botón (inicio/parada).
- Interruptor de seguridad: las cuchillas se activan solo cuando la tapa está correctamente cerrada.
- Depósito para 60 g de granos de café molido.
- Almacenamiento para el cable.
- Libre de BPA.

- Ideal for grinding coffee and other products such as seeds, herbs, nuts, cereals, salt, pepper or spices.
- 100% stainless steel: body and blades made of maximum quality stainless steel.
- Transparent lid: upper transparent color lid to display the ground grain.
- On/off switch: operation with a simple button (start/stop).
- Safety switch: The blades are activated only when the lid is correctly closed.
- Deposit for 60 g of ground coffee beans.
- Cable storage.
- BPA free.

Molinillo de café Limu
Moulin à café · Kaffeemühle
Coffe grinder · Moedor de café

| Ref | € | W | Capacidad contenedor | U.Venta |
|-------|-------|-----|----------------------|---------|
| 69385 | 38,20 | 200 | 60 g | 1 |

Cafeteras de goteo

INOX VIDRIO Glass CE  Household use

new



- Cafetera de goteo programable, permite programar hasta 24 horas antes para tener el café recién echo a la hora deseada.
- Tecnología AromaTech: Disfruta del sabor intenso del café gracias al sistema de rociado y goteo continuo.
- Función KeepWarm: La placa calefactora mantiene el café caliente hasta 40 minutos.
- Filtro reutilizable. También permite usar filtros de papel.
- Pantalla LCD retroiluminada, jarra de cristal termorresistente y depósito con ventana para controlar el nivel del agua en todo momento.
- 900 W de potencia con capacidad de 1,50 litros para preparar hasta 12 tazas de café.
- Incluye cuchara dosificadora para preparar y calcular la cantidad de café.

- Programmable drip coffee maker that can be programmed up to 24 hours in advance to enjoy freshly brewed coffee at the time you want.
- AromaTech technology: enjoy the intense flavour of coffee thanks to the continuous drip and spray system.
- KeepWarm function: the hot plate keeps the coffee hot for 40 minutes.
- Reusable filter. Compatible with paper filters.
- Backlit LCD display, heat-resistant glass jug and tank with window to monitor the water level at all times.
- 900 W power and 1.5 L capacity to brew up to 12 cups of coffee.
- Includes measuring spoon to prepare and calculate the exact amount of coffee.



Mantiene el café caliente hasta 40 min
Keeps coffee hot for up to 40 min



Tecnología AromaTech
Technology

Cafetera de goteo Drop
Café filtre · Filterkaffee
Filter coffee machine · Café tipo filtro

| Ref | € | W | Capacidad | Medidas | U.Venta |
|-------|-------|-----|-----------|---------------|---------|
| 69279 | 77,40 | 900 | 1,5L | 20x28x36,5 cm | 1 |



- Puede dosificar la cantidad de café.
- Una vez encendida nos podemos desentender de ella.
- Si la jarra se completa, mantiene el café caliente y se puede consumir en cualquier momento.

- Vous pouvez dose la quantité de café.
- Une fois que vous pouvez le ignorer.
- Si la cruche est terminée, gardez le café chaud et peut être consommé à tout moment.

- You can dose the amount of coffee.
- Once you can disregard it.
- If the jug is completed, keep the coffee hot and can be consumed at any time.



Cafetera de goteo Black

Cafetière filtre électrique · Filter-Kaffeemaschine
Filter coffe machine · Café tipo filtro

| Ref | € | W | Capacidad | Tazas | Medidas | U.Venta |
|-------|-------|------|-----------|-------|-------------|---------|
| 69278 | 55,20 | 1000 | 1,25L | 10 | 31x21x22 cm | 1 |

Professional use



Máquina de café Auto

Machine à café automatique · Automatische Kaffeemaschine
Automatic coffee machine · Máquina automática do café

| Ref | € | W | Capacidad | Medidas | U.Venta |
|-------|--------|--------|-----------|-------------|---------|
| 69272 | 509,20 | 2100 W | 1,8L x 2 | 20x36x41 cm | 1 |



Pack 200 filtros

Pack 200 filtros · Pack200 Filter
Pack filters U.Venta · Pack 200 filtros

| Ref | € | Ø (cm) | U.Venta |
|-------|-------|--------|---------|
| 69274 | 16,90 | 25 | 1 |
| 69275 | 14,50 | 20 | 1 |



Placa calentamiento jarra café

Plaque chauffante pour cruche de café · Heizplate für Kaffeekanne
Heating plate for coffee jug · Placa de aquecimento caneca de café

| Ref | € | W | Ø Placa | Temperatura | Medidas | U.Venta |
|-------|--------|-----|---------|-------------|--------------|---------|
| 69282 | 121,70 | 180 | 11 | 80°C | 38x20,5x7 cm | 1 |



Jarra café Cristal

Basse en verre pichet · Glass Kaffee Krug
Glass coffee jug · Caneca de café em vidro

| Ref | € | Capacidad | U.Venta |
|-------|-------|-----------|---------|
| 69273 | 29,90 | 1,8L | 1 |

Cafetera Superautomática Sabore

new



Household use



- Cafetera superautomática compacta y diseñada para los amantes del café recién molido.
- Disfruta del café recién hecho con grano molido.
- Se puede ajustar la cantidad de café para cada una de las 3 funciones.
- Molinillo ajustable de muelas cónicas: 15 niveles de molienda. Ajusta el grano de molienda a tu gusto.
- Gran capacidad: Hasta 180 gramos de café y depósito de agua de 1,5L.
- Calentamiento ThermoBlock: Sistema eléctrico de calentamiento del agua ultra rápido. Disfruta de un café recién molido al instante.
- Doble salida de café regulable en altura desde 8,5 cm hasta 11,5 cm.
- AutoClean System: Sistema de limpieza automático.
- Molinillo y depósito para residuo totalmente accesible: facilita su limpieza.
- Incluye vaporizador para calentar y espumar la leche o calentar agua para infusiones.
- Pantalla intuitiva táctil.

- Compact superautomatic coffee machine designed for lovers of freshly ground coffee.
- Enjoy freshly brewed coffee with ground beans.
- The amount of coffee can be adjusted for each of the 3 functions.
- Adjustable conical grinder: 15 grinding levels. Adjust the grind to your taste.
- Large capacity: Up to 180 grams of coffee and 1.5L water tank.
- ThermoBlock heating: Ultra-fast electric water heating system. Enjoy freshly ground coffee instantly.
- Double coffee spout adjustable in height from 8.5 cm to 11.5 cm.
- AutoClean System: Automatic cleaning system.
- Fully accessible grinder and waste container: easy to clean.
- Includes frother for heating and frothing milk or heating water for infusions.
- Intuitive touch screen

Cafetera automática Sabore

Machine à café automatique · Automatische Kaffeemaschine
Automatic coffee machine · Máquina de café automática

| Ref | € | W | Capacidad | Capacidad contenedor | Presión | Medidas | U.Venta |
|-------|--------|------|-----------|----------------------|---------|-------------|---------|
| 69435 | 554,10 | 1350 | 1,5L | 180g | 20 bar | 44x19x32 cm | 1 |

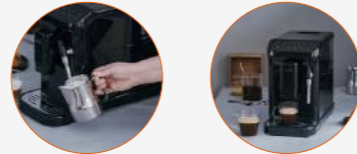

Cafeteras Espresso



Household use



- Cafetera espresso de acero inoxidable con diseño elegante y compacto.
- Consigue un café perfecto y rápido gracias a su potencia de 1450 W y sus 20 bares de presión.
- Su sistema de calentamiento rápido Thermoblock calienta el agua en segundos.
- Función manual y automática. Permite programar el ciclo de vertido a tu gusto.
- Incluye vaporizador con rotación para espumar leche y preparar cappuccino. También dispensa agua caliente para las infusiones.
- Brazo portafiltros con doble salida, te permite preparar uno o dos cafés simultáneamente.
- Depósito de agua extraíble de 1,25 litros de capacidad con marcas de máximo y mínimo. Libre de BPA.
- Incluye cucharilla dosificadora con prensador para el café y 3 filtros (individual, doble y para usar cápsulas ESE) para acoplar al brazo de la cafetera.
- Bandeja de goteo desmontable con indicador de nivel para facilitar la limpieza.
- Sistema de ahorro energético con apagado automático.

- Espresso stainless steel cafeter with elegain and compact design
- Get a perfect and fast coffee thanks to its power of 1450 W and its 20 pressure bars.
- Your fast heating system Thermoblock heats the water in seconds.
- Manual and automatic function. Allows you to program the dumping cycle to your liking.
- Includes rotation vaporizer for foam milk and prepare cappuccino. It also dispenses hot water for infusions.
- Double outlet portfiltros arm, allows you to prepare one or two coffees simultaneously.
- Removable water tank of 1.25 liters capacity with maximum and minimum marks. BPA free.
- Includes dosing teaspoon with coffee presser and 3 filters (individual, double and to use that) to attach to the coffee maker.
- Removable drip tray with level indicator to facilitate cleaning.
- Energy savings system with automatic shutdown.

INOX

Cafetera espresso Compact

Cafetière espresso · Espresso-Maschine
Espresso coffee maker · Cafeteira espresso

| Ref | € | W | Capacidad | Presión | Medidas | U.Venta |
|-------|--------|------|-----------|---------|-------------|---------|
| 69429 | 235,20 | 1450 | 1,25L | 20 bar | 14x31x31 cm | 1 |



INOX

Cafetera espresso Sence

Cafetière espresso · Espresso-Maschine
Espresso coffee maker · Cafeteira espresso

| Ref | € | W | Capacidad | Presión | Medidas | U.Venta |
|-------|--------|-----|-----------|---------|---------------|---------|
| 69256 | 189,20 | 850 | 1,5L | 15 bar | 21x26,5x30 cm | 1 |



- Cafetera espresso de acero inoxidable con diseño elegante y compacto.
- Ideal para preparar todo tipo de cafés, espresso, cappuccino, latte machiato, té o infusiones.
- Café perfecto y rápido gracias a su potencia y sus bares de presión.
- Sistema de calentamiento rápido Thermoblock, calienta el agua en segundos.
- Fácil de usar, muy intuitiva. Indicadores luminosos en cada función.
- Función manual y automática. Permite programar el ciclo de vertido a tu gusto.
- Incluye vaporizador con rotación para espumar leche, preparar cappuccinos y también dispensar agua caliente para las infusiones.
- Brazo portafiltros con doble salida; te permite preparar uno o dos cafés simultáneamente.
- Depósito de agua extraíble con marcas de máximo y mínimo. Libre de BPA.

- Stainless steel espresso machine with elegant and compact design.
- Ideal to prepare all kinds of coffees, espresso, cappuccino, late machiato, teas or infusions.
- Perfect and fast coffee thanks to its power and pressure bars.
- Thermoblock fast heating system, heats the water in seconds.
- Easy to use, very intuitive. Luminous indicators in each function.
- Manual and automatic function. Allows you to program the dumping cycle to your liking.
- Includes rotation vaporizer for milk foam, prepare cappuccinos and also dispense hot water for infusions.
- Portafiltros arm with double outlet; It allows you to prepare one or two coffees simultaneously.
- Removable water tank with maximum and minimum marks. BPA free.

INOX

Cafetera Espresso Pro

Cafetière espresso · Espresso-Maschine
Espresso coffee maker · Cafeteira espresso

| Ref | € | W | Capacidad | Capacidad contenedor | Presión | Medidas | U.Venta |
|-------|--------|------|-----------|----------------------|---------|-----------------|---------|
| 69428 | 659,40 | 1550 | 2,8L | 250 g (café/Coffee) | 20 bar | 31x34,5x41,5 cm | 1 |



- Fabricada en acero inoxidable con acabado pulido.
- Molinillo con fresa cónica de acero inoxidable integrado, proporciona la cantidad necesaria de café.
- Depósito de café de 250 g con opción de regular entre 30 tipos de molido. Libre de BPA.
- Control de temperatura PID. Alcanza la temperatura de extracción óptima.
- Función manual y automática. Permite programar la cantidad de vertido a tu gusto.
- Incluye vaporizador con rotación para espumar la leche y preparar cappuccino. También dispensa agua caliente para las infusiones.
- Brazo portafiltros con doble salida; te permite preparar uno o dos cafés simultáneamente.
- Depósito de agua extraíble de 2,8 litros de capacidad con marcas de máximo y mínimo. Libre de BPA.
- Incluye prensador de acero inoxidable para el café, 2 filtros (individual y doble) para acoplar al brazo de la cafetera y jarra de acero inoxidable de 0,46 L para la leche.

- Made of stainless steel with polished finish.
- Milling with conical stainless steel strawberry integrated, provides the necessary quantity of coffee.
- 250 g coffee tank with an option to regulate between 30 types of ground. BPA free.
- PID temperature control. Reach the optimal extraction temperature.
- Manual and automatic function. It allows to program the amount of discharge to your liking.
- Includes rotation vaporizer to foam milk and prepare cappuccino. It also dispenses hot water for infusions.
- Portafiltros arm with double outlet; It allows you to prepare one or two coffees simultaneously.
- Removable water tank of 2.8 liters of capacity with maximum and minimum marks. BPA free.
- Includes stainless steel presier for coffee, 2 filters (individual and double) to attach the coffee maker and 0.46 l stainless steel jug for milk.

Espumadores de leche

CE  Household use



Calentar y espumar.
Espumar leche fría
Heat and froth. Froth cold milk



Calentar
Heat



Espumador de leche Latte

Mousseur à lait · Milchaufschäumer
Milk frother · Espumador de leite

| Ref | € | W | Capacidad | Capacidad espuma | Medidas | U. Venta |
|-------|-------|-----|-----------|------------------|-----------|----------|
| 69396 | 63,50 | 500 | 240ml | 115 ml | Ø10x21 cm | 1 |

Espumador de leche Magnetic

Mousseur à lait · Milchaufschäumer
Milk frother · Espumador de leite

| Ref | € | W | Capacidad | Capacidad espuma | Medidas | U. Venta |
|-------|-------|-----|-----------|------------------|-------------|----------|
| 69398 | 78,90 | 600 | 250ml | 115 ml | Ø12x19,5 cm | 1 |

Tostadoras Buffet

INOX 18/10   Professional use



Tostador Continue

Grille-painl · Toaster
Toaster · Torradeira

| Ref | € | W | Velocidad | Medidas | U. Venta |
|-------|--------|------|---------------|-------------------|----------|
| 69065 | 858,70 | 1340 | 0,46-0,73m/mi | 42x28,5x42 cm | 1 |
| 69066 | 990,40 | 2240 | 0,46-0,73m/mi | 41,6x36,8x29,5 cm | 1 |



Tostador Buffet

Grille-painl · Toaster
Toaster · Torradeira

| Ref | € | W | Ranuras | Medidas | U. Venta |
|-------|--------|--------|---------|-----------------|----------|
| 69294 | 237,00 | 1800 W | 4 | 30x24,5x21,5 cm | 1 |
| 69296 | 314,80 | 2500 W | 6 | 43,5x26x22 cm | 1 |



Tostador Horizontal

Grille-painl · Toaster
Toaster · Torradeira

| Ref | € | W | Tiempo | Número de lámparas | Grill | Medidas | U. Venta |
|---------|--------|------|----------|--------------------|----------|--------------|----------|
| A 69172 | 364,00 | 2400 | 0-15 min | 6 | 40x24 cm | 50x29x28cm | 1 |
| B 69173 | 430,20 | 3600 | 0-15 min | 9 | 40x24 cm | 50x29x37,5cm | 1 |

Tostadoras

INOX   Household use



Tostadora Smart

Grille-pain · Toaster
Toaster · Torradeira

| | Ref | € | W | Ranuras | Medidas ranura | Medidas | U. Venta |
|---|-------|-------|------|---------|----------------|-----------------|----------|
| A | 69440 | 74,90 | 1500 | 2 | 3,8x25 cm | 40,3x17,8x19 cm | 1 |
| B | 69442 | 63,80 | 800 | 2 | 3,8x14 cm | 29,3x17,7x19 cm | 1 |
| C | 69444 | 89,90 | 1750 | 4 | 3,8x14 cm | 28,8x31,5x19 cm | 1 |



Tostadora Long

Grille-pain · Toaster
Toaster · Torradeira

| Ref | € | W | Ranuras | Medidas ranura | Medidas | U. Venta |
|-------|-------|------|---------|----------------|-------------|----------|
| 69260 | 59,20 | 1400 | 2 | 25x4 cm | 38x18x20 cm | 1 |



Tostadora Duplo

Grille-pain · Toaster
Toaster · Torradeira

| Ref | € | W | Ranuras | Medidas ranura | Medidas | U. Venta |
|-------|-------|------|---------|----------------|---------------|----------|
| 69360 | 65,40 | 1000 | 1 | 25 cm | 41x12x18,5 cm | 1 |



Tostadora Curve

Grille-pain · Toaster
Toaster · Torradeira

| | Ref | € | W | Ranuras | Medidas ranura | Medidas | U. Venta |
|---|-------|-------|------|---------|----------------|-------------|----------|
| F | 69062 | 53,20 | 1000 | 2 | 14x4 cm | 19x29x19 cm | 1 |
| G | 69064 | 80,10 | 1750 | 4 | 14x4 cm | 33x29x19 cm | 1 |



Basic



Easy

Tostadora Horizontal

Toaster horizontal · Horizontal-/Toaster
Electric toaster · Torradeira horizontal

| | Ref | € | W | Número de lámparas | Grill | Medidas | U. Venta |
|---|-------|-------|-----|--------------------|----------|--------------|----------|
| D | 69163 | 33,90 | 600 | 2 | 25x20 cm | 36x21x6,5 cm | 1 |
| E | 69363 | 42,40 | 600 | 2 | 25x20 cm | 42x30x9 cm | 1 |

Exprimidor profesional

CE  Professional use

- Cuenta con una potencia potente y materiales de gran calidad para que puedas exprimir todo tipo de frutas y cítricos.
- Sistema de puesta en marcha automático al presionar la palanca.
- Cono de acero inoxidable extraíble, apto para el lavavajillas hasta 90°C.
- Tiempo máximo en funcionamiento continuo: 30 minutos.

- Sa puissance et ses matériaux de haute qualité vous permettent de presser toutes sortes de fruits et d'agrumes.
- Système de mise en service automatique lorsque vous appuyez sur le levier.
- Côneau en acier inoxydable amovible, adapté au lave-vaisselle jusqu'à 90 ° C.
- Temps maximum en fonctionnement continu: 30 minutes.

- It has a powerful power and high quality materials so you can squeeze all kinds of fruits and citrus fruits.
- Automatic commissioning system when pressing the lever.
- Removable stainless steel cone, suitable for dishwasher up to 90°C.
- Maximum time in continuous operation: 30 minutes.



AL INOX
Aluminium 18/10

Exprimidor profesional Inox
Presse-fruits professionnelle · Profi-Zitruspresse
Professional squeezer · Espremedor profesional

| Ref | € | W | Velocidad | Medidas | U.Venta |
|-------|--------|-----|-----------|-------------|---------|
| 69283 | 447,20 | 230 | 980 rpm | 28x20x40 cm | 1 |



FE
Iron

Exprimidor profesional Black
Presse-fruits professionnelle · Profi-Zitruspresse
Professional squeezer · Espremedor profesional

| Ref | € | W | Velocidad | Medidas | U.Venta |
|-------|--------|-----|-----------|-------------|---------|
| 69286 | 224,40 | 180 | 1350 rpm | 31x22x35 cm | 1 |

Exprimidor Automático

ABS   Household use



Exprimidor totalmente automático, gracias a su innovadora tecnología la fruta se exprime pulsando solo un botón
This totally automatic juicer squeezes fruit with the touch of a button.



Exprimidor automático
Presse-agrumes automatique · Automatische Saftpresse
Automatic juicer · Espremedor automático

| Ref | € | W | Capacidad | Medidas | U.Venta |
|-------|-------|----|-----------|-------------|---------|
| 69520 | 84,90 | 60 | 400ml | 20x19x31 cm | 1 |

532

Exprimidor de Zumo

PP INOX *Household use*
Polypropylene



Exprimidor de palanca Vitally
Presse-fruit · Zitruspresse
Orange squeezer · Espremedor de sumos

| Ref | € | W | Medidas | U.Venta |
|---------|--------|-----|---------------|---------|
| A 69120 | 96,80 | 160 | 19,5x29x29 cm | 1 |
| B 69231 | 129,90 | 160 | 19,5x29x29 cm | 1 |



Exprimidor de zumos Power
Presse-fruit · Zitruspresse
Orange squeezer · Espremedor de sumos

| Ref | € | W | Medidas | U.Venta |
|-------|-------|-----|-------------|---------|
| 69280 | 56,30 | 100 | Ø14,5x25 cm | 1 |



Exprimidor de palanca Energy
Presse-fruit · Zitruspresse
Orange squeezer · Espremedor de sumos

| Ref | € | W | Medidas | U.Venta |
|-------|-------|-----|--------------|---------|
| 69285 | 67,90 | 100 | Ø 20 x 30 cm | 1 |



Exprimidor de zumos Spirit
Presse-fruit · Zitruspresse
Orange squeezer · Espremedor de sumos

| Ref | € | W | Medidas | U.Venta |
|-------|-------|-----|---------------|---------|
| 69287 | 68,60 | 100 | 18x16,5x25 cm | 1 |



Exprimidor de zumos Zitrus
Presse-fruit · Zitruspresse
Orange squeezer · Espremedor de sumos

| Ref | € | W | Capacidad | Medidas | U.Venta |
|-------|-------|----|-----------|-------------|---------|
| 69575 | 24,40 | 40 | 750ml | Ø19x20,5 cm | 1 |

533

Licadoras

INOX PP AS CE
Polypropylene Plastic



Professional use

- Fabricada en acero inoxidable de alta calidad muy robusta y potente.
- Diseñada para uso continuo.
- Su potente motor, su gran velocidad y su gran orificio de entrada permiten preparar de forma rápida nutritivos zumos de frutas o verduras con expulsión automática de la pulpa.
- Contenedor de residuos de gran tamaño.
- Mecanismo de cierre con interruptor de seguridad.
- Filtro microperforado de acero inoxidable.
- Componentes desmontables fáciles de limpiar.

- Fabriqué en acier inoxydable de haute qualité très robuste et puissant.
- Conçu pour une utilisation continue.
- Son moteur puissant, sa grande vitesse et son grand trou d'entrée permettent de préparer rapidement des jus de fruits nutritifs ou des légumes avec une expulsion automatique de la pulpe.
- Grand récipient à déchets.
- Mécanisme de clôture avec commutateur de sécurité.
- Filtre microperforé en acier inoxydable.
- Composants amovibles faciles à nettoyer.

- Made of high quality stainless steel very robust and powerful.
- Designed for continuous use.
- Its powerful engine, its great speed and its great entry hole allow to quickly prepare nutritious fruit juices or vegetables with automatic pulp expulsion.
- Large waste container.
- Closing mechanism with safety switch.
- Stainless steel microperforated filter.
- Removable components easy to clean.

Licadora Profesional Pro

Centrifugeuse professionnel · Professioneller zitrus entsafter
Professional juice extractor · Liquidificador profesional

| Ref | € | W | Par motor | Capacidad contenedor | Ø (cm) | Medidas | U.Venta |
|-------|---------|-----|-----------|----------------------|-------------|-------------------|---------|
| 69488 | 1170,20 | 700 | 2,9 Nm | 6 L (residuos) | 9 (entrada) | 47,3x25,3x52,2 cm | 1 |



Licuadora Ecolo

Fruit centrifugeuse · Zitrus entsafter
Juice extractor · Liquidificador de zumos

| Ref | € | W | Velocidad | Capacidad contenedor | Medidas | U.Venta |
|-------|--------|-----|-----------|----------------------|-------------|---------|
| 69373 | 422,40 | 240 | 60 rpm | 10L | 29x20x44 cm | 1 |

Household use

- Tecnología "SLOW": Mediante el sistema de rotación lenta y el método de prensado en frío, permite obtener todos los nutrientes de frutas y verduras a diferencia de los exprimidores tradicionales. Ultrasilencioso gracias a su motor de bajas revoluciones.
- Mezcla frutas y verduras en el interior del recipiente antes de verterlo en la jarra.
- Introduce los ingredientes enteros permitiendo acelerar el tiempo dedicado a la extracción del zumo.
- Fácil limpieza. Cepillo para limpiar las partes internas. Accesorios aptos para el lavavajillas.

- Technologie «lente»: Grâce au système de rotation lent et à la méthode de pressage à froid, il permet d'obtenir tous les nutriments des fruits et légumes contrairement aux polistes traditionnels. Ultrasilencioso grâce à son moteur à faible révolution.
- Mélanger les fruits et légumes à l'intérieur du récipient avant de le verser dans la cruche.
- Entrez l'ensemble des ingrédients permettant d'accélérer le temps consacré à l'extraction du jus.
- Nettoyage facile. Badigeonner pour nettoyer les pièces internes. Accessoires adaptés au lave-vaisselle.

- "Slow" technology. Through the slow rotation system and the cold pressing method, it allows to obtain all the nutrients of fruits and vegetables unlike traditional polisters. Ultrasilencioso thanks to its low revolution engine.
- Mix fruits and vegetables inside the container before pouring it into the jug.
- Enter the entire ingredients allowing accelerating the time dedicated to juice extraction.
- Easy cleaning. Brush to clean the internal parts. Accessories suitable for dishwasher.



Incluye RECETARIO
RECIPE BOOK included

Household use

- Fabricada en acero inoxidable de alta calidad muy robusta y potente.
- Diseñada para uso continuo.
- Su potente motor, su gran velocidad y su gran orificio de entrada permiten preparar de forma rápida nutritivos zumos de frutas o verduras con expulsión automática de la pulpa.
- Contenedor de residuos de gran tamaño.
- Mecanismo de cierre con interruptor de seguridad.
- Filtro microperforado de acero inoxidable.
- Componentes desmontables fáciles de limpiar.

- Fabriqué en acier inoxydable de haute qualité très robuste et puissant.
- Conçu pour une utilisation continue.
- Son moteur puissant, sa grande vitesse et son grand trou d'entrée permettent de préparer rapidement des jus de fruits nutritifs ou des légumes avec une expulsion automatique de la pulpe.
- Grand récipient à déchets.
- Mécanisme de clôture avec commutateur de sécurité.
- Filtre microperforé en acier inoxydable.
- Composants amovibles faciles à nettoyer.

- Made of high quality stainless steel very robust and powerful.
- Designed for continuous use.
- Its powerful engine, its great speed and its great entry hole allow to quickly prepare nutritious fruit juices or vegetables with automatic pulp expulsion.
- Large waste container.
- Closing mechanism with safety switch.
- Stainless steel microperforated filter.
- Removable components easy to clean.



Licadora Nutrily

Fruit centrifugeuse · Zitrus entsafter
Juice extractor · Liquidificador de zumos

| Ref | € | W | Par motor | Capacidad contenedor | Ø (cm) | Medidas | U.Venta |
|-------|--------|-----|-----------|----------------------|---------------|-------------|---------|
| 69288 | 100,20 | 850 | 0,387 Nm | 2 L | 7,5 (entrada) | 30x20x36 cm | 1 |

INOX CE ROHS Household use



Procesador de alimentos Soak

Robot culinaire · Küchenmaschine
Food processor · Processador de alimentos

| Ref | € | W | Velocidad | Capacidad | Calentamiento | Medidas | U.Venta |
|-------|--------|-----|-----------|-----------|---------------|-------------|---------|
| 69380 | 214,20 | 450 | 17000 rpm | 1,7L | 700-900 W | 25x21x45 cm | 1 |

- Cocine sopas caseras, salsas, purés, cremas, batidos, zumos, cócteles, etc.
- Saltear ingredientes, cocinar a fuego lento o hervir sopas.
- Mezcla los ingredientes durante el proceso de cocción.
- Pica hielo en menos de 50 segundos y mezcla desde batidos hasta cócteles congelados.

- Cuire les soupes, les sauces, les purés, les crèmes, les milkshakes, les jus, les cocktails, etc.
- Gardez les ingrédients, cuire à feu doux ou faire bouillir les soupes.
- Mélanger les ingrédients pendant le processus de cuisson.
- De la glace à pica en moins de 50 secondes et mélange des milkshakes aux cocktails surgelés.

- Cook homemade soups, sauces, purés, creams, milkshakes, juices, cocktails, etc.
- Save ingredients, cook over low heat or boil soups.
- Mix the ingredients during the cooking process.
- Pica ice in less than 50 seconds and mix from milkshakes to frozen cocktails.

Batidoras personales



- **Elabora sin esfuerzo batidos, cremas y zumos de fruta y verdura en segundos.**
- **Las cuchillas de acero inoxidable pulverizan las semillas, cortan las pieles y Trituran las partes densas y fibrosas de los alimentos hasta el punto de mantener la máxima cantidad de nutrientes.**
- **Funcionamiento muy sencillo, solo hay que presionar la jarra o botón para que el motor active las cuchillas.**
- **Incluye dos jarras de trítan libres de BPA.**

- Faire des broches, des crèmes et des jus de fruits et légumes en quelques secondes.
- Les lames en acier inoxydable vaporisent les graines, coupent les peaux et écrasent les fibres denses et les fibres au point de maintenir la quantité maximale de nutriments.
- Fonctionnement très simple, il vous suffit d'appuyer sur le pot vers le moteur activer les lames.
- Il comprend deux cruches de Tritan sans BPA.

- Make spits, creams and juices of fruit and vegetables in seconds.
- Stainless steel blades spray the seeds, cut the skins and crush the dense and fibrous of food to the point of maintaining the maximum amount of nutrients.
- Very simple operation, you just have to press the jar to the engine activate the blades.
- It includes two jugs of BPA-free tritan.



2 jarras trítan (0,5/1 L)
Two tritan pitchers (0,5/1 L)



INOX

Batidora personal Pro

Mixeur personnel · Mini-Standmixer
Individual blender · Batedeira pessoal

| Ref | € | W | Capacidad | Cuchillas | Medidas | U.Venta |
|-------|--------|------|-----------|-----------|---------------|---------|
| 69389 | 102,60 | 1200 | 0,5/1L | 4 | 14x14x40,5 cm | 1 |



Batidora personal Mix & Go

Personnelle mixeur · Personliche mixer
Personal blender · Misturador pessoal

| Ref | € | W | Capacidad | Medidas | U.Venta |
|-------|-------|-----|-----------|---------------|---------|
| 69382 | 51,40 | 350 | 300/600ml | 12x12x40,5 cm | 1 |



CRISTAL
Glass

Batidora personal Mix & Go con jarra de cristal

Mixeur personnel MIX & GO avec bol en verre · Mini-Standmixer MIX & GO mit Glasbehälter
MIX & GO individual blender with glass jug · Batedeira pessoal MIX & GO com jarra de vidro

| Ref | € | W | Capacidad | Medidas | U.Venta |
|-------|-------|-----|-----------|-----------|---------|
| 69386 | 47,90 | 350 | 500ml | Ø12x31 cm | 1 |

Apta para la batidora
69386/69382
Suitable for
blender
69386/69382



CRISTAL
Glass

Set 2 jarras de cristal

Set de 2 pichets en verre · 2er-Set Glasbehälter
Set of 2 glass pitchers · Conjunto de 2 jarras de vidro

| Ref | € | Capacidad | U.Venta |
|-------|-------|-----------|---------|
| 69387 | 19,60 | 500ml | 1 |

Jarra de vidrio templado
(500 ml)
High quality toughened glass
(500 ml)

Incluye 4 pajitas desechables de papel ecológico
Includes 4 disposable
straws made from
eco-friendly paper



Set 4 pajitas + cepillo

Plaque à induction a/regulateur · Induktionskochfeld m/ regler
Round induction plate with power control · Placa de indução com regulador

| Ref | € | Color | Ø (cm) | Largo (cm) | U.Venta |
|---------|------|---------|--------|------------|---------|
| A 63131 | 5,00 | Inox | 0,6 | 21,5 | 1 |
| B 63133 | 3,10 | Cristal | 0,6 | 21,5 | 1 |



Batidoras profesionales



Batir, picar y moler
Blend, chop and grind



Batidora profesional Black
Batteur professionnel · Profi-Mixer
Professional blender · Batedor profesional

Batidora profesional White
Batteur professionnel · Profi-Mixer
Professional blender · Batedor profesional

| Ref | € | W | Velocidad | Capacidad | Medidas | U. Venta |
|-------|--------|------|-----------------|-----------|-------------|----------|
| 69195 | 498,90 | 1200 | 13300-38000 rpm | 2L | 28x26x52 cm | 1 |

| Ref | € | W | Velocidad | Capacidad | Medidas | U. Venta |
|-------|--------|------|-----------------|-----------|-------------|----------|
| 69295 | 431,60 | 1200 | 13000-38000 rpm | 1,5L | 18x24x42 cm | 1 |

Accesorios

Apta para las batidoras 69195 y 69295
Apt for blenders 69195 and 69295



Jarra batidora con cuchilas Black
Pot batteur avec lamestl · Krug mit Messer für Mixer
Blender jug with blades · Jarra batedora com lâminas

| Ref | € | Capacidad | U. Venta |
|---------|--------|-----------|--------------|
| R69195N | 195,70 | 2L | 1 |
| R69195B | 49,30 | - | 1 Tapa · Lid |

Apta para las batidoras 69195 y 69295
Apt for blenders 69195 and 69295



Jarra batidora con cuchilas White
Pot batteur avec lamestl · Krug mit Messer für Mixer
Blender jug with blades · Jarra batedora com lâminas

| Ref | € | Capacidad | U. Venta |
|---------|--------|-----------|--------------|
| R69295A | 193,10 | 1,5L | 1 |
| R69295D | 76,70 | - | 1 Tapa · Lid |

· **Aísla y reduce el nivel de ruido un 80%. Apta para las batidoras 69195 y 69295.**
· **NOTA: La carcasa solo es valida si las batidoras llevan la jarra baja (R69295A), NUNCA con la jarra alta (R69195N).**

· Isolates and reduces the noise level by 80%. Apt for blenders 69195 and 69295.
· NOTE: The casing is only valid if the blender comes with a lower recipient (R69295A), NEVER for a higher recipient (R69195N).



PC
Polycarbonate

Carcasa aislante de ruido
Boîtier isolant du bruit · Geräuschdämpfendes Gehäuse
Noise reducing enclosure · Carcaça isolante do ruído

| Ref | € | Medidas | h(cm) | U. Venta |
|---------|--------|---------|-------|----------|
| R69295B | 250,80 | 25x30cm | 46 | 1 |



Posibilidad de encastrar.
Dimensiones del agujero: 25,5 x 26,5 cm.

Possibilité d'encastrer.
Dimensions du trou : 25,5 x 26,5 cm.

Encastrable option.
Dimensions of the hole: 25,5 x 26,5 cm.

Batidoras con jarra



Sistema Patentado



Doble rodamiento ·
Double ball bearing
Alarga la vida útil de las cuchillas
Extend the lifespan of the blades



Eje central conjunto
Central assembly axis
Eje central cuchillas
Central blades axis
Eje central de las cuchillas descentrada respecto al eje central del conjunto.
Crea vórtices irregulares, evita obstrucciones y genera cortes más profundos.
Central blade axis offset from the central assembly axis.
Creates uneven vortices, avoid blockages and make deeper cuts.



Batidora Inox
Mélangeur · Mixer
Blender · Batedor

| Ref | € | W | Velocidad | Capacidad | Medidas | U. Venta |
|-------|--------|------|-------------------|-----------|-----------------|----------|
| 69581 | 160,70 | 1000 | 11000 - 16500 rpm | 1,5L | 20,5x20x41,5 cm | 1 |



Batidora White
Mélangeur · Mixer
Blender · Batedor

| Ref | € | W | Velocidad | Capacidad | Medidas | U. Venta |
|-------|-------|-----|-------------------|-----------|-------------|----------|
| 69587 | 82,20 | 700 | 14400 - 16000 rpm | 1,5L | 22x18x40 cm | 1 |

Jarra de vidrio borosilicato con escala
(ml / cups / oz)
Borosilicate glass pitcher (ml / cups / oz)



Batidora Vita
Mixer · Mixer
Blender · Batedora

| Ref | € | W | Velocidad | Capacidad | Medidas | U. Venta |
|-------|-------|-----|-----------------|-----------|-------------|----------|
| 69081 | 87,70 | 500 | 10000-12000 rpm | 1,5L | 21x23x40 cm | 1 |



Máquinas de vacío

INOX Professional use

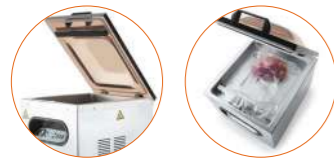

- Máquina de envasadora vacío campana de uso profesional.
- Aumenta el tiempo de conservación de los alimentos crudos o cocinados.
- Envasado por mediación de un compresor de aire.
- Compresor con pistón, dispone de válvula de entrada y salida de aire.
- Panel de control muy intuitivo y sencillo de utilizar.
- Envasado de líquidos.
- Especial para marinados.
- Doble soldadura para garantizar la estanqueidad del sellado.
- Tapa amortiguada de policarbonato transparente.
- Altura interior útil: 11 cm.
- Largura del sellado: 29 cm. Anchura del sellado: 4 cm.

- Empty Packaging machine Bell for professional use.
- Increase the conservation time of raw or cooked food.
- Packaged by mediation of an air compressor.
- Piston compressor, has air inlet and output valve.
- Very intuitive and simple control panel.
- Liquid packaging.
- Special for marinados.
- Double welding to guarantee the sealing.
- Transparent polycarbonate damping lid.
- Useful interior height: 11 cm.
- Sealing length: 29 cm. Sealing width: 4 cm.

Máquina de vacío campana Chef

Machine sous vide à cloche · Vakuümiergeräte
Bell-shaped vacuum machine · Máquina de vacío tipo cámara

| Ref | € | W | Presión | Caudal bomba | Medidas internas | Medidas | U.Venta |
|-------|---------|-----|---------|--------------|----------------------|---------------|---------|
| 69116 | 1756,40 | 630 | 0,9 bar | 83 L/min | 35x30x5 cm (campana) | 42x36x36,5 cm | 1 |



- Máquina de envasadora vacío campana de uso profesional.
- Aumenta el tiempo de conservación de los alimentos crudos o cocinados.
- Sellado por compresor de aire de gran potencia.
- Panel de control digital.
- Incluye porta rollos en su interior.
- Sirve para bolsas gofradas de hasta 30 cm y rollos (incluido un rollo).
- Diseñado especialmente para productos secos, húmedos y líquidos.
- Incluye función solo de vacío.
- Largura del sellado: 30 cm. Anchura del sellado: 2,5 cm.
- Caudal bomba: 60 litros/minuto.

- Empty Packaging machine Bell for professional use.
- Increase the conservation time of raw or cooked food.
- Sealed by large -power air compressor.
- Digital Control Panel.
- Includes roll holder inside.
- It serves for enrolled bags up to 30 cm and rolls (including a roll).
- Designed especially for dry, wet and liquid products.
- Includes empty function.
- Sealing length: 30 cm. Sealing width: 2.5 cm.
- Pump flow: 60 liters/minute.

Máquina de vacío campana Black

Machine sous vide à cloche · Vakuümiergeräte
Bell-shaped vacuum machine · Máquina de vacío tipo cámara

| Ref | € | W | Presión | Caudal bomba | Medidas internas | Medidas | U.Venta |
|-------|--------|-----|---------|--------------|--------------------------|-------------|---------|
| 69352 | 998,90 | 350 | 0,9 bar | 60 L/min | 30,5x32,2x8 cm (campana) | 42x38x27 cm | 1 |



Máquina de vacío Profesional

Machine sous vide · Vakuümiergerät
Vacuum pack machine · Máquina de vacío

| | Ref | € | W | Presión | Caudal bomba | Largo sellado | Medidas | U.Venta |
|---|-------|--------|-----|---------|--------------|---------------|---------------|---------|
| A | 69530 | 552,20 | 700 | 0,9 Bar | 16 L/min | 31 cm | 39x27,5x13 cm | 1 |
| B | 69540 | 613,60 | 650 | 0,9 Bar | 16 L/min | 40 cm | 49x26x12,5 cm | 1 |



Compatible para bobinas hasta:
Compatible for coils up to:
69531 - 30 cm /
69541 - 40 cm

Soporte para rollo

Porte-rouleau · Rollenhalter
Roll holder · Soporte de rolo

| Ref | € | Largo (cm) | U.Venta |
|-------|-------|------------|---------|
| 69531 | 25,20 | 30 | 1 |
| 69541 | 30,60 | 40 | 1 |



Barra para corte instantáneo
Orificio para la aspiración de los botes
Bar for instant cutting
Opening for the sealing of canisters

3 niveles de tiempo de sellado (secos, húmedos...)
Doble bomba de vacío
Three levels of sealing time
(dry, wet, etc.). Dual vacuum pump

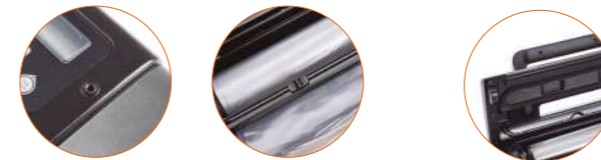

INOX

Máquina de vacío Efficient

Machine sous vide · Vakuümiergerät
Vacuum pack machine · Máquina de vacío

| Ref | € | W | Presión | Caudal bomba | Largo sellado | Medidas | U.Venta |
|-------|--------|-----|---------|---------------------|---------------|-------------|---------|
| 69353 | 229,60 | 130 | 0,9 Bar | 20 L/min (2 bombas) | 2 x 2 mm | 40x20x11 cm | 1 |

Semiprofesional use

- Máquina de envasado al vacío profesional con carcasa externa de acero inoxidable, robusta e higiénica (libre de BPA).
- Ideal para preparar sous vide, marinar platos, almacenar distintos alimentos naturales o cocinados, etc.
- Aumenta la vida útil de los alimentos gracias al buen sellado hermético que proporciona la máquina.
- Garantiza sabor, valor nutricional, frescura y protección de los alimentos.
- Funcionamiento intuitivo y sencillo: envasado automático, función de sellado continuo, función marinado (muy útil para ahorrar tiempo frente a los marinados convencionales) y función cánister.
- Ahorra tiempo y dinero.
- Está equipada con una barra de sellado extra ancha de 5 mm.
- Doble bomba de vacío muy potente, garantiza un vacío óptimo.
- Gracias a su asa en la tapa el envasado al vacío es más cómodo.
- Se apoya en cuatro pies de goma para una mayor estabilidad.

- Ideal to prepare sous vide, marinate dishes, store different natural or cooked foods, etc.
- Increase the life of food thanks to the good hermetic sealing that the machine provides.
- It guarantees flavor, nutritional value, freshness and food protection.
- Intuitive and simple operation: automatic packaging, continuous sealing function, marinated function (very useful to save time against conventional marinates) and Canister function.
- Save time and money.
- It is equipped with an extra 5 mm wide sealed bar.
- Double very powerful vacuum pump, guarantees an optimal vacuum.
- Thanks to your handle on the lid, vacuum packaging is more comfortable.
- It relies on four feet of rubber for greater stability.

Accesorios

Bobinade 28 cm x 5 m (incluida)
Doble banda de sellado
28 cm x 5 m coil tube (included)
Wide double-band

Incluye 10 bolsas de vacío (20x30 cm)
Includes 10 vacuum bags (20x30 cm)

Función canister
Canister function



Máquina de vacío Home

Machine sous vide · Vakuümiergerät
Vacuum pack machine · Máquina de vacío

| Ref | € | W | Presión | Caudal bomba | Largo sellado | Medidas | U.Venta |
|-------|---------------|-----|---------|--------------|---------------|--------------|---------|
| 69050 | 110,00 | 110 | 0,8 bar | 9 L/min | 28 cm | 35,5x15x9 cm | 1 |

Incluye 10 bolsas de vacío: 20x30 cm (5) / 28x40 cm (5)
Includes 10 vacuum bags: 20x30 cm (5) / 28x40 cm (5)

Máquina de vacío Luxe

Machine sous vide · Vakuümiergerät
Vacuum pack machine · Máquina de vacío

| Ref | € | W | Presión | Caudal bomba | Largo sellado | Medidas | U.Venta |
|-------|---------------|-----|---------------|--------------|---------------|----------------|---------|
| 69151 | 124,70 | 120 | 0,4 - 0,8 bar | 9 L/min | 30 cm | 37x14,5x7,5 cm | 1 |



AutoPlace

Garantiza la colocación correcta de la bolsa
Placement correct des sacs garanti · Ensures bags are inserted correctly



Tapa totalmente extraíble
Totally removable lid

Incluye accesorio para función canister
Accessory for canister function included

Máquina de vacío Smart

Machine sous vide · Vakuümiergerät
Vacuum pack machine · Máquina de vacío

| Ref | € | W | Presión | Caudal bomba | Largo sellado | Medidas | U.Venta |
|-------|---------------|-----|---------|--------------|---------------|------------|---------|
| 69357 | 105,60 | 120 | 0,8 bar | 5 L/min | 30 cm | 38x16x6 cm | 1 |



AutoPlace

Garantiza la colocación correcta de la bolsa
Placement correct des sacs garanti · Ensures bags are inserted correctly

Máquina de vacío AutoPro

Machine sous vide · Vakuümiergerät
Vacuum pack machine · Máquina de vacío

| Ref | € | W | Presión | Caudal bomba | Largo sellado | Medidas | U.Venta |
|-------|--------------|-----|---------|--------------|---------------|----------------|---------|
| 69356 | 98,00 | 120 | 0,8 bar | 4,3 L/min | 30 cm | 37,8x17x5,8 cm | 1 |



Orificio para la aspiración de los botes
Opening for the sealing of canisters



Máquina de vacío Slim

Machine sous vide · Vakuümiergerät
Vacuum Upackmaschine · Máquina de vacío

| Ref | € | W | Presión | Caudal bomba | Largo sellado | Medidas | U.Venta |
|-------|--------------|----|---------|--------------|---------------|-----------------|---------|
| 69354 | 81,50 | 80 | 0,5 Bar | 4 L/min | 2 mm | 38,4x9,7x5,7 cm | 1 |



Compartimento para líquidos
Compartment for liquids

Incluye:

5 bolsas de 20x30cm / Bobina de 20cmx2m
Tubo canister de 40 cm de largo
Includes: 5 20x30cm bags / 20cmx2m coil tube
40 cm-long canister hose



Máquina de vacío Extreme

Machine de conditionnement sous vide · Vakuümiergerät
Vacuum machine · Máquina de vacío

| Ref | € | W | Presión | Caudal bomba | Largo sellado | Medidas | U.Venta |
|-------|---------------|-----|---------|--------------|---------------|--------------|---------|
| 69355 | 148,50 | 110 | 0,8 Bar | 12 L/min | 30 cm | 42x9,5x15 cm | 1 |



- Sella herméticamente los alimentos aumentando de 3 a 5 veces más tiempo su durabilidad. Expulsa el aire y la humedad, manteniendo sus sabores y nutrientes.
- Ideal para alimentos sólidos, carnes, pescados, embutidos, legumbres, verduras, tanto frescos como cocinados, alargando su conservación.
- 2 niveles de sellado: uno para alimentos húmedos y otro para alimentos secos.
- Compartimento para rollo de 28 cm x 3 m (incluido) con barra para corte instantáneo.
- Opción de vaciado manual; diseñado para obtener presión de vacío adecuada en el caso de alimentos frágiles (pescado, por ejemplo).
- Gracias a su asa integrada en la tapa el envasado al vacío será más cómodo.
- Carcasa externa de acero inoxidable, robusta e higiénica.
- Contiene orificio para la aspiración de los botes. Incluye adaptador para botes de vacío.

- Hermetically seals food, increasing its shelf life by 3 to 5 times. Expels air and moisture and retains flavours and nutrients. Ideal for solid food, meat, fish, sausages, pulses, vegetables, both fresh and cooked, extending their shelf life.
- 2 sealing levels: one for wet food and the other for dry food.
- Compartment for 28 cm x 3 m roll (included) with bar for instant cutting.
- Manual vacuum option: designed to ensure adequate vacuum pressure for fragile food (e.g. fish).
- Features an integrated handle on the lid to simplify the vacuum packaging process.
- Robust and hygienic stainless steel outer casing.
- Contains canister vacuuming hole. Includes canister vacuuming adapter.



Barra para corte instantáneo
Instant cutter bar

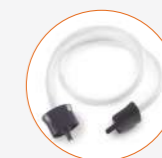

Incluye adaptador para botes de vacío y bobina de 28 cm x 3 m
Includes adapter for canister and 28 cm x 3m roll



Máquina de vacío Ingenious

Machine à vide Ingenious · Vakuümmaschine Ingenious
Vacuum machine Ingenious · Máquina de vacío Ingenious

| Ref | € | W | Presión | Caudal bomba | Largo sellado | Medidas | U.Venta |
|-------|---------------|-----|---------|--------------|---------------|---------------|---------|
| 69358 | 146,40 | 120 | 0,8 bar | 12 L/min | 28 cm | 40x17,5x10 cm | 1 |



Bobinas, botes y bolsas de vacío

PE
Polyethylene
BPA free
Professional use

- Apto para uso alimenticio.
- Recomendada para uso con máquina de vacío de la marca LACOR.
- No se recomienda su reutilización tras el uso con carnes, pescados y otros alimentos deteriorables, tan solo tras el uso en productos secos, legumbres, frutos secos, etc.

- Adaptée au conditionnement de denrées alimentaires.
- Recommandée pour être utilisée avec la machine à emballer sous vide LACOR.
- Son utilisation est déconseillée pour reconditionner de la viande, du poisson et d'autres denrées Alimentaires périssables. Elle peut être réutilisée pour reconditionner des fruits secs, des légumes, des fruits secs, etc.

- Suitable for use with food.
- Recommended for use with vacuum Packer of the LACOR brand.
- Not recommended to be reused after use with meats, fish and other fresh foods, only after use with dried products, pulses, nuts, etc.



Bobina tubo vacío

Bobine de tube · Vakuumbutel Rollen
Coil tube · Bobina manga

| Ref | € | Micras | Bobina | U.Venta |
|-------|-------|--------|------------------|---------|
| 69052 | 14,30 | 105 | 28cmx5m, 22cmx5m | 1 |
| 69057 | 9,70 | 105 | 14cmx10m | 6 |
| 69059 | 13,40 | 105 | 22cmx10m | 1 |
| 69058 | 17,50 | 105 | 28cmx10m | 1 |
| 69451 | 19,70 | 105 | 40cmx10m | 1 |
| 69259 | 9,00 | 105 | 28cmx5m | 1 |
| 69458 | 11,60 | 90 | 28cmx5m | 1 |
| 69459 | 9,20 | 90 | 22cmx5m | 6 |
| 69462 | 9,90 | 105 | 28cmx5m, 22cmx5m | 1 |
| 69463 | 8,70 | 105 | 22cmx10m | 1 |
| 69464 | 11,00 | 105 | 28cmx10m | 1 |
| 69452 | 6,10 | 105 | 12cmx10m | 6 |

Bolsas de vacío

Sacs de conservation sous vide · Vakuumbutel, 100 Stueck
Vacuum bags · Sacos de vacío

| Ref | € | Micras | Unidad | Medidas | U.Venta |
|-------|--------|--------|--------|------------------|---------|
| 69053 | 5,20 | 105 | 25 | 20 x 16 x 1,5 cm | 6 |
| 69054 | 8,80 | 105 | 25 | 30 x 20 x 1,5 cm | 6 |
| 69055 | 11,90 | 105 | 25 | 35 x 25 x 2 cm | 1 |
| 69056 | 14,90 | 105 | 25 | 40 x 28 x 2 cm | 1 |
| 69042 | 32,70 | 105 | 100 | 30 x 20 x 3 cm | 1 |
| 69046 | 47,70 | 105 | 100 | 36 x 25 x 6 cm | 1 |
| 69047 | 65,00 | 105 | 100 | 40 x 30 x 5 cm | 1 |
| 69048 | 130,40 | 105 | 100 | 45 x 37 x 10 cm | 1 |
| 69453 | 6,10 | 90 | 25 | 16 x 20 x 1,5 cm | 6 |
| 69454 | 11,20 | 90 | 25 | 30 x 20 x 1,5 cm | 1 |
| 69455 | 15,60 | 90 | 25 | 36,5 x 24 x 3 cm | 1 |
| 69460 | 5,70 | 105 | 25 | 30 x 20 x 2 cm | 1 |
| 69461 | 10,20 | 105 | 25 | 40 x 28 x 2 cm | 1 |

Set 3 botes vacío hogar + adaptador

3 boîte sous vide + Adaptateur · 3 Vakuumbehälter-Set + Adapter
3 Shape canister set + Adapter · Conj. 3 caixas vácuo domésticas + Adaptador

| Ref | € | Capacidad | U.Venta |
|-------|-------|----------------|---------|
| 69051 | 37,30 | 0,7L/ 1,4L/ 2L | 1 |



Máquina de vacío / Vacuum Pack machine

| Model | 69354 | 69355 | 69356 | 69357 | 69151 | 69050 | 69353 | 69540 | 69530 | 69352 | 69116 |
|----------|-------|-------|-------|-------|-------|-------|-------|-------|-------|-------|---------------------|
| 69052 | ✓ | ✓ | ✓ | ✓ | ✓ | ✓ | ✓ | ✓ | ✓ | ✓ | ✓ |
| 69057 | ✓ | ✓ | ✓ | ✓ | ✓ | ✓ | ✓ | ✓ | ✓ | ✓ | ✓ |
| 69059 | ✓ | ✓ | ✓ | ✓ | ✓ | ✓ | ✓ | ✓ | ✓ | ✓ | ✓ |
| 69058 | ✓ | ✓ | ✓ | ✓ | ✓ | ✓ | ✓ | ✓ | ✓ | ✓ | ✓ |
| 69451 | ✓ | ✓ | ✓ | ✓ | ✓ | ✓ | ✓ | ✓ | ✓ | ✓ | ✓ |
| 69259 | ✓ | ✓ | ✓ | ✓ | ✓ | ✓ | ✓ | ✓ | ✓ | ✓ | ✓ |
| 69458 | ✓ | ✓ | ✓ | ✓ | ✓ | ✓ | ✓ | ✓ | ✓ | ✓ | ✓ |
| 69459 | ✓ | ✓ | ✓ | ✓ | ✓ | ✓ | ✓ | ✓ | ✓ | ✓ | ✓ |
| 69462 | ✓ | ✓ | ✓ | ✓ | ✓ | ✓ | ✓ | ✓ | ✓ | ✓ | ✓ |
| 69463 | ✓ | ✓ | ✓ | ✓ | ✓ | ✓ | ✓ | ✓ | ✓ | ✓ | ✓ |
| 69464 | ✓ | ✓ | ✓ | ✓ | ✓ | ✓ | ✓ | ✓ | ✓ | ✓ | ✓ |
| 69053 | ✓ | ✓ | ✓ | ✓ | ✓ | ✓ | ✓ | ✓ | ✓ | ✓ | ✓ |
| 69054 | ✓ | ✓ | ✓ | ✓ | ✓ | ✓ | ✓ | ✓ | ✓ | ✓ | ✓ |
| 69055 | ✓ | ✓ | ✓ | ✓ | ✓ | ✓ | ✓ | ✓ | ✓ | ✓ | ✓ |
| 69056 | ✓ | ✓ | ✓ | ✓ | ✓ | ✓ | ✓ | ✓ | ✓ | ✓ | ✓ |
| 69042 | ✓ | ✓ | ✓ | ✓ | ✓ | ✓ | ✓ | ✓ | ✓ | ✓ | ✓ |
| 69046 | ✓ | ✓ | ✓ | ✓ | ✓ | ✓ | ✓ | ✓ | ✓ | ✓ | ✓ |
| 69047 | ✓ | ✓ | ✓ | ✓ | ✓ | ✓ | ✓ | ✓ | ✓ | ✓ | ✓ |
| 69453 | ✓ | ✓ | ✓ | ✓ | ✓ | ✓ | ✓ | ✓ | ✓ | ✓ | ✓ |
| 69454 | ✓ | ✓ | ✓ | ✓ | ✓ | ✓ | ✓ | ✓ | ✓ | ✓ | ✓ |
| 69455 | ✓ | ✓ | ✓ | ✓ | ✓ | ✓ | ✓ | ✓ | ✓ | ✓ | ✓ |
| 69460 | ✓ | ✓ | ✓ | ✓ | ✓ | ✓ | ✓ | ✓ | ✓ | ✓ | ✓ |
| 69461 | ✓ | ✓ | ✓ | ✓ | ✓ | ✓ | ✓ | ✓ | ✓ | ✓ | ✓ |
| 69048(*) | ✓ | ✓ | ✓ | ✓ | ✓ | ✓ | ✓ | ✓ | ✓ | ✓ | ✓ |
| 69452 | ✓ | ✓ | ✓ | ✓ | ✓ | ✓ | ✓ | ✓ | ✓ | ✓ | ✓ |
| 69051 | | | | | | | | | | | 0,7 - 1,4 2, 0 L |

(*) Apta para la máquina de vacío 69040 (descatalogada)

■ Bolsas y rollos para uso exclusivo del SOUS VIDE





Colección Sous Vide



- Técnica culinaria que prima la calidad del producto.
- Resultados sorprendentes; alimentos más jugosos, tiernos y succulentos.
- Preserva las cualidades del producto y realiza su sabor y textura.

- Technique culinaire qui privilégie la qualité du produit.
- Résultats surprenants ; aliments plus juteux, tendres et succulents.
- Préserve les qualités du produit et améliore sa saveur et sa texture.

- Culinary technique that enhances the quality of the product.
- Amazing results; juicier, more tender and more succulent food.
- Preserves the qualities of the product and enhances its flavour and texture.

new



- Carcasa fabricada en acero inoxidable 18/10.
- Resistente, robusto y duradero, garantiza un rendimiento profesional.
- Diseñado para profesionales; especialmente para su uso en restaurantes, bares, hoteles, etc.
- Gran efectividad y máxima precisión: garantiza resultados excepcionales en cada plato.
- Control preciso de la temperatura: El caudal de la bomba de agua permite calentar recipientes de hasta 80 litros consiguiendo una temperatura uniforme en toda su área. Preservando así las cualidades del producto y realizando su sabor y textura.
- Interfaz intuitiva.
- Alarma de bajo nivel de agua y desconexión automática.
- Portátil, compacto y muy fácil de transportar.
- Pinza de sujeción apta para cualquier recipiente.
- Máxima impermeabilidad gracias a su sistema IPX7.

- Boîtier en acier inoxydable 18/10.
- Solide, robuste et durable, il garantit des performances professionnelles.
- Conçu pour les professionnels, notamment dans les restaurants, les bars, les hôtels, etc.
- Rendement élevé et précision maximale : garantis des résultats exceptionnels pour chaque plat.
- Contrôle précis de la température : le débit de la pompe à eau permet de chauffer des récipients jusqu'à 80 litres, en obtenant une température uniforme dans toute la zone. Cela permet de préserver les qualités du produit et d'en améliorer la saveur et la texture.
- Interface intuitive.
- Alarme de bas niveau d'eau et arrêt automatique.
- Portable, compact et très facile à transporter.
- Pince adaptée à tout type de récipient.
- Étanchéité maximale grâce au système IPX7.

- Housing made of 18/10 stainless steel.
- Strong, robust and durable, it guarantees professional performance.
- Designed for professionals; especially for use in restaurants, bars, hotels, etc.
- High efficiency and maximum precision: guarantees exceptional results in every dish.
- Precise temperature control: The flow rate of the water pump makes it possible to heat containers of up to 80 litres, achieving a uniform temperature throughout the entire area. This preserves the qualities of the product and enhances its flavour and texture.
- Intuitive interface.
- Low water level alarm and automatic shut-off.
- Portable, compact and easy to transport.
- Clamp suitable for any container.
- Maximum waterproofness thanks to its IPX7 system.



Protection Against Temporary immersion

Professional use

Sous Vide Master

Sous Vide · Sous Vide
Sous Vide · Sous Vide

| Ref | € | W | Caudal bomba | Temperatura | Capacidad | Tiempo | U.Venta |
|-------|--------|------|--------------|-------------|-----------|--------|---------|
| 69592 | 526,20 | 2300 | 10 L/min | 5°C-95°C | 80L | 99 | 1 |

Nutrientes
100 %
Nutrient



Protection Against Temporary immersion

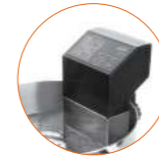

Professional use

Sous vide Pro

Sous Vide · Sous Vide
Sous Vide · Sous Vide

| Ref | € | W | Caudal bomba | Temperatura | Presión | Capacidad | Tiempo | U.Venta |
|-------|--------|------|--------------|-------------|---------|-----------|--------|---------|
| 69192 | 474,10 | 1500 | 6 L/min | 5-99°C | 0,1°C | 40L | 0-99 h | 1 |

Nutrientes
100 %
Nutrient



Protection Against Temporary immersion



Semiprofessional use

Sous vide Precise

Sous Vide · Sous Vide
Sous Vide · Sous Vide

| Ref | € | W | Caudal bomba | Temperatura | Presión | Capacidad | Tiempo | U.Venta |
|-------|--------|------|--------------|-------------|---------|-----------|----------------|---------|
| 69304 | 315,20 | 1200 | 4,5 L/min | 5-99°C | 0,1°C | 30L | Hasta 99 horas | 1 |

Nutrientes
100 %
Nutrient



Protection Against Temporary immersion



Household use

Sous vide Gourmet

Sous Vide · Sous Vide
Sous Vide · Sous Vide

| Ref | € | W | Temperatura | Presión | Capacidad | Tiempo | U.Venta |
|---------|--------|------|-------------|---------|-----------|--------|---------|
| A 69302 | 208,30 | 1200 | 20-90°C | 1°C | 15L | 99 h | 1 |
| B 69303 | 208,30 | 1200 | 20-90°C | 1°C | 15L | 99 h | 1 |





Professional use

- Cocina alimentos envasados al vacío a baja temperatura.
- Alimentos más tiernos, sabrosos y con la mejor textura.
- Resultados de alta calidad.
- Carcasa robusta fabricada íntegramente en acero inoxidable.
- Cierre hermético gracias a la tapa con borde de silicona.
- Incluye rejilla divisoria para la separación de las bolsas.
- Pantalla digital de tiempo y temperatura.
- Termostato de gran precisión ajustable: 30°C - 90°C (0,1 °C).
- Temporizador ajustable: 99 horas. 6 memorias. Capacidad: 17 litros.
- Filtro de seguridad para evitar impurezas en el sistema de recirculación del agua.
- Incorpora grifo de vaciado.

- Cuire les aliments emballés à basse température.
- Aliments plus tendres et savoureux et avec la meilleure texture.
- Résultats de haute qualité.
- Logement robuste fabriqué entièrement en acier inoxydable.
- Clôture hermétique grâce au couvercle de bord en silicone.
- Comprend la division de la grille pour la séparation des sacs.
- Écran numérique du temps et de la température.
- Thermostat d'une grande précision réglable: 30 ° C - 90 ° C (0,1 ° C).
- Minuterie réglable: 99 heures. 6 souvenirs. Capacité: 17 litres.
- Filtre de sécurité pour éviter les impuretés dans le système de recirculation de l'eau.
- Intègre le robinet de vidange.

- Cooking food packaged at low temperature.
- Easier, tasty foods and with the best texture.
- High quality results.
- Robust housing manufactured entirely in stainless steel.
- Hermetic closure thanks to the silicone edge lid.
- Includes dividing grid for the separation of the bags.
- Time and temperature digital screen.
- Thermostat of great adjustable precision: 30°C - 90 ° C (0.1 ° C).
- Adjustable timer: 99 hours. 6 memories. Capacity: 17 liters.
- Security filter to avoid impurities in the water recirculation system.
- Incorporates emptying tap.

Cocedor Sous vide

Cuiseur Sous Vide · Sous-Vide-Kochapparat
Sous Vide cooker · Máquina de cozinhar a vácuo Sous Vide

| Ref | € | W | Caudal bomba | Temperatura | Presión | Capacidad | Tiempo | Medidas | U.Venta |
|-------|--------|------|--------------|-------------|---------|-----------|--------|---------------|---------|
| 69492 | 729,70 | 1600 | 4L/min | 30-95°C | 0,1°C | 17L | 0-99h | 62,5x36x30 cm | 1 |



Semiprofessional use

- Técnica culinaria que prima la calidad del producto.
- Diseñado para uso semi profesional. Tamaño compacto.
- Fabricada en acero inoxidable de gran calidad.
- Resultados sorprendentes; alimentos más jugosos, tiernos y succulentos.
- Preserva las cualidades del producto y realza su sabor y textura.
- Panel de control táctil súper intuitivo.

- Culinary technique that puts the quality of the product first.
- Designed for semi-professional use, compact size.
- Made of high quality stainless steel.
- Surprising results; juicier, more tender and succulent food.
- Preserves the qualities of the product and enhances its flavour and texture.



Sous vide con tapa

Sous Vide avec couvercle · Sous Vide mit Deckel
Sous Vide with lid · Sous Vide com tampa

| Ref | € | W | Caudal bomba | Temperatura | Presión | Capacidad | Tiempo | Medidas | U.Venta |
|-------|--------|-----|--------------|-------------|---------|-----------|--------|-----------------|---------|
| 69193 | 748,60 | 620 | 6 L/min | 5-99°C | 0,1°C | 12,5L | 0-99 h | 27 x 29 x 42 cm | 1 |

Accesorios Sous Vide

Professional use



PP
Polypropylene



Bolsas aislantes para sous vide

Billes isolantes p/appareils de conditionnement Sous-Vide · Isolationskugeln
Sous Vide Insulation Balls · Esferas isolantes para Sous Vide

| Ref | € | Ø (cm) | Unidad | U.Venta |
|-------|-------|--------|--------|---------|
| 69219 | 29,00 | 2,0 | 100 | 1 |

- Bolas aislantes huecas y flotantes de polipropileno (PP), libres de BPA, para dispositivos sous-vide.
- Crean una capa de aislamiento evitando la pérdida de calor en un 75% y en un 90% la evaporación del agua.
- Permiten hervir agua durante horas sin tener que echar más, gracias al mínimo contacto entre agua y aire.
- Aumentan la precisión de la temperatura y ayudan a mantener los envasados al vacío bajo el agua.
- Reducen humos y riesgos de salpicaduras.
- Soportan hasta 150°C sin ningún problema.
- Compatibles con recipientes de todas las formas y tamaños.
- Se presenta con una práctica malla con cierre de cordón.

- Hollow and floating insulating balls of polypropylene (PP), BPA free, for sous-vide devices.
- They create an insulation layer avoiding heat loss by 75% and at 90% the evaporation of water.
- They allow boiling water for hours without having to throw more, thanks to the minimum contact between water and air.
- They increase temperature precision and help keep vacuum underwater.
- They reduce smoke and splashes risks.
- They support up to 150°C without any problem.
- Compatible with containers of all shapes and sizes.
- It is presented with a practice mesh with cord closure.



Perfecta capa de aislamiento
Perfect insulation layer

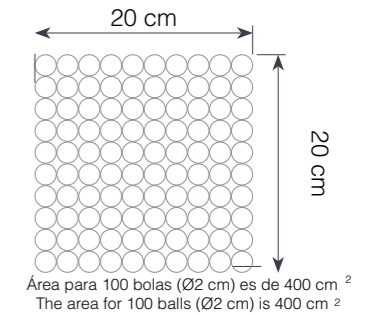

- Su diseño es ideal para la sujeción en vertical de 4 bolsas de vacío.
- Evita que las bolsas floten y entren en contacto con las paredes o fondo de las cubetas.
- Permite la circulación del agua entre las bolsas en todo momento, consiguiendo una cocción uniforme.
- Agiliza introducir y retirar las bolsas con facilidad.

- Sa conception est idéale pour le support vertical de 4 sacs à vide.
- Il empêche les sacs de farine et entrez en contact avec les murs ou le fond des seaux.
- Il permet à tout moment la circulation de l'eau entre les sacs, en réalisant une cuisson uniforme.
- La dalle introduit et retirez facilement les sacs.

- Its design is ideal for vertical support of 4 vacuum bags.
- It prevents the bags from flour and come into contact with the walls or background of the buckets.
- It allows the circulation of water between the bags at all times, achieving a uniform cooking.
- Slabe introduce and remove the bags easily.



INOX
18/10

Rejilla Sous vide

Rack pour Sous Vide · Rack für Sous Vide
Rack for sous vide · Cremalheira para sous Vide

| Ref | € | Diámetro varilla (mm) | Medidas | U.Venta |
|-------|-------|-----------------------|-----------------|---------|
| 67051 | 16,50 | 4 | 20x13,5x13,5 cm | 1 |





Armarios refrigeradores Black

AL Aluminium   *Semiprofessional use*

- Diseñado para refrigerar eficazmente botellas de vino y otras bebidas.
 - La temperatura interior puede ser ajustada mediante el control electrónico.
 - Puerta con cámara de cristal templado y sistema de apertura con tirador.
 - Estantes extraíbles.
 - Silencioso y sistema antivibratorio.
 - Pies regulables en altura.
 - **NOTA: deje suficiente espacio en la parte trasera (mínimo 5 cm) para permitir la salida del calor y una adecuada ventilación.**
 - Vinoteca termoelectrónica: el control y regulación de la temperatura dependerá de la temperatura ambiental del establecimiento.
- Conçu pour réfrigérer efficacement les bouteilles de vin et autres boissons.
 - La température intérieure peut être ajustée par contrôle électronique.
 - Porte avec chambre de verre trempée et système d'ouverture avec un tireur.
 - Étagères amovibles.
 - Système silencieux et antivibratoire.
 - Hauteur - Pieds ajustés.
 - Remarque: laissez suffisamment d'espace à l'arrière (minimum 5 cm) pour permettre la sortie de chaleur et une ventilation adéquate.
 - Bibliothèque de vin thermoélectrique: le contrôle et la régulation de la température dépendra de la température ambiante de l'établissement.
- Designed to effectively refrigerate wine bottles and other drinks.
 - The interior temperature can be adjusted by electronic control.
 - Door with temperate glass chamber and opening system with a shooter.
 - Removable shelves.
 - Silent and antivibratory system.
 - Height -adjustable feet.
 - Note: Leave enough space in the back (minimum 5 cm) to allow heat outlet and adequate ventilation.
 - Thermoelectric wine library: The control and regulation of temperature will depend on the ambient temperature of the establishment.

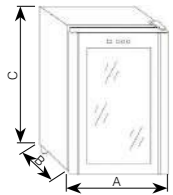

Armarios refrigeradores Black
 Refroidisseur à vin · Thermo Weinkühler
 Thermo wine cooler · Armário refrigerador

| | Ref | € | W | Botellas | Temperatura | Consumo (g/h) | Medidas | U.Venta |
|----------|-------|--------|----|----------|-------------|---------------|---------------|---------|
| A | 69670 | 396,10 | 70 | 8 | 1-18°C | 190 kWh/annum | 26x49,5x48 cm | 1 |
| B | 69671 | 425,20 | 70 | 12 | 1-18°C | 129 kWh/annum | 34,5x48x47 cm | 1 |
| C | 69672 | 472,00 | 70 | 18 | 1-18°C | 146 kWh/annum | 34,5x48x67 cm | 1 |
| D | 69673 | 530,40 | 70 | 28 | 1-18°C | 179 kWh/annum | 45x52x72,5 cm | 1 |



Armarios con compresor Merlot

AL Aluminium   *Semiprofessional use*

- **Armario refrigerador con sistema de enfriamiento por compresor.**
 - Diseñado para refrigerar eficazmente botellas de vino y otras bebidas.
 - La temperatura interior puede ser ajustada mediante el control electrónico.
 - Acabado en acero inoxidable y cristal negro.
 - Puerta con cámara de cristal templado y sistema de apertura con tirador.
 - Estantes extraíbles acabados en madera.
 - Silencioso y sistema antivibratorio.
 - Pies regulables en altura.
 - **NOTA: deje suficiente espacio en la parte trasera (mínimo 5 cm) para permitir la salida del calor y una adecuada ventilación.**
- Armoire au réfrigérateur avec système de refroidissement du compresseur.
 - Conçu pour réfrigérer efficacement les bouteilles de vin et autres boissons.
 - La température intérieure peut être ajustée par contrôle électronique.
 - Finition en acier inoxydable et verre noir.
 - Porte avec chambre de verre trempée et système d'ouverture avec un tireur.
 - Étagères amovibles en bois.
 - Système silencieux et antivibratoire.
 - Hauteur - Pieds ajustés.
 - Remarque: laissez suffisamment d'espace à l'arrière (minimum 5 cm) pour permettre la sortie de chaleur et une ventilation adéquate.
- Refrigerator wardrobe with compressor cooling system.
 - Designed to effectively refrigerate wine bottles and other drinks.
 - The interior temperature can be adjusted by electronic control.
 - Stainless steel finish and black glass.
 - Door with temperate glass chamber and opening system with a shooter.
 - Removable shelves in wood.
 - Silent and antivibratory system.
 - Height -adjustable feet.
 - Note: Leave enough space in the back (minimum 5 cm) to allow heat outlet and adequate ventilation.



Armarios con compresor Merlot

Refroidisseur à vin à compresseur · Weinkühler mit Kompressor
 Compressor type wine cooler · Refrigerador de vinho do tipo compresso

| | Ref | € | W | Botellas | Temperatura | Consumo (g/h) | Ruido | Refrigerante | Medidas | U.Venta |
|----------|-------|--------|----|----------|-------------|---------------|-------|--------------|---------------------|---------|
| A | 69700 | 537,80 | 85 | 12 | 5-18°C | 107 kWh/año | 45 dB | R600a | 44x47x53 cm | 1 |
| B | 69701 | 553,50 | 85 | 12 | 5-18°C | 136 kWh/año | 45 dB | R600a | 25x45x79 cm | 1 |
| C | 69702 | 828,50 | 85 | 18 | 5-18°C | 145 kWh/año | 46 dB | R600a | 34,5x48x83 cm | 1 |
| D | 69239 | 452,50 | 85 | 18 | 5-18°C | 120 kWh/año | 42 dB | R600a | 34,5 x 45 x 77,5 cm | 1 |
| E | 69238 | 482,50 | 85 | 28 | 5-18°C | 189 kWh/año | 42 dB | R600a | 43,2 x 45 x 84,5 cm | 1 |
| F | 69703 | 863,10 | 85 | 51 | 5-18°C | 156 kWh/annum | 47 dB | R600a | 49,5x56,5x85 cm | 1 |

* **Dispone de doble cámara con temperaturas independientes (ref.69702).**
 It has a double chamber with independent temperatures (ref. 69702).



Sacacorchos



Semiprofessional use

- Diseño elegante, moderno y ergonómico: ideal para su uso profesional y de hogar.
- Funcionamiento rápido y sencillo tan solo pulsando un botón.
- Facilita la extracción del corcho de cualquier botella de vino en tan solo 6-8 segundos.
- Extrae el corcho suavemente y de forma silenciosa.
- Cabezal de extracción con iluminación led.
- Indicador de batería luminoso mediante LED: 4 niveles para indicar el nivel de energía.
- Se carga mediante cable Micro USB.
- Incluye: cable cargador USB y descapsulador.

- Design élégant, moderne et ergonomique: idéal pour un usage professionnel et à domicile.
- Fonctionnement rapide et simple simplement en appuyant sur un bouton.
- Il facilite l'extraction du bouchon de n'importe quelle bouteille de vin en seulement 6 à 8 secondes.
- Extraire le liège doucement et silencieusement.
- Tête d'extraction avec éclairage LED.
- Indicateur de batterie LED Utilisation de LED: 4 niveaux pour indiquer le niveau d'énergie.
- Il est chargé par un câble micro USB.
- Comprend: câble de chargeur USB et décapsules.

- Elegant, modern and ergonomic design: ideal for professional and home use.
- Fast and simple operation just by pressing a button.
- It facilitates the extraction of the cork of any wine bottle in just 6-8 seconds.
- Extract the cork gently and silently.
- Extraction head with LED lighting.
- LED battery indicator using LED: 4 levels to indicate the energy level.
- It is loaded by micro USB cable.
- Includes: USB charger cable and decapsulator.



Autonomía
Battery life
30-40
Botellas
Bottles



Autonomía
Battery life
30-40
Botellas
Bottles



Sacacorchos Black Luxe

Tire-bouchon · Korkenzieher
Corkscrew · Saca-rolhas

| Ref | € | Ø (cm) | h(cm) | U.Venta |
|-------|-------|--------|-------|---------|
| 63056 | 39,30 | 4,8 | 22 | 1 |



Autonomía
Battery life
30
Botellas
Bottles



Sacacorchos Black

Tire-bouchon · Korkenzieher
Corkscrew · Saca-rolhas

| Ref | € | Ø (cm) | h(cm) | U.Venta |
|-------|-------|--------|-------|---------|
| 63057 | 30,40 | 5 | 19 | 1 |



Autonomía
Battery life
30-40
Botellas
Bottles



Sacacorchos eléctrico AutoPro

Tire bouchon électrique · Korkenzieher, elektrisch
Electric corkscrew · Saca-rolhas Eléctrico

| Ref | € | cm | U.Venta |
|-------|-------|--------|---------|
| 63031 | 41,80 | Ø12x32 | 1 |



Autonomía
Battery life
30
Botellas
Bottles



Sacacorchos eléctrico Smart

Tire bouchon électrique · Korkenzieher, elektrisch
Electric corkscrew · Saca-rolhas Eléctrico

| Ref | € | cm | U.Venta |
|-------|-------|-------|---------|
| 63054 | 44,90 | Ø5x25 | 1 |



Autonomía
Battery life
30-40
Botellas
Bottles



Click here



Refrigeradores Bar



Professional use



Mini bar Vista

Mini frigo bar · Minibar Kühlschrank
Mini-bar refrigerator · Refrigerador mini-bar

| Ref | € | W | Capacidad | Temperatura | Consumo | Ruido | Medidas | U.Venta |
|-------|--------|----|-----------|-------------|--------------------|-------|-------------|---------|
| 69675 | 258,40 | 70 | 36L | 11°C-18°C | 176 kWh/año (year) | 26 dB | 43x41x51 cm | 1 |



Puerta reversible
Reversible door

- Diseñado para hoteles, bares, campings y ocinas.
- Funcionamiento termoelectrico, ideal para refrigerar y mantener cualquier bebida o alimento fresco.
- Totalmente silencioso.
- Puerta reversible de cristal templado transparente con cierre hermético.
- Capacidad de 36 litros.
- Termostato regulador de temperatura para asegurar que los productos se mantienen frescos y en perfectas condiciones.
- Iluminación interna mediante LED.
- Incluye una bandeja interna.
- Descongelación automática inteligente, evita la acumulación de hielo en el interior del minibar.
- Specially designed for hotels, bars, ofices and camping.
- Thermoelectric operation: ideal for refrigerating food or drinks and keeping them cool.
- Totally silent.
- Reversible door made of transparent, hermetically sealed tempered glass.
- Capacity: 36 L.
- Temperature controlling thermostat to keep all items fresh and in perfect condition.
- Internal LED lighting.
- Comes with 1 inner rack.
- Smart auto defrost technology to prevent ice from building up inside.

A



B



Puerta reversible
Reversible door

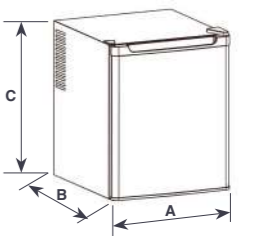

No introduzca alimentos o bebidas calientes
Do not introduce hot food or drinks

Mini bar

Mini frigo bar · Minibar Kühlschrank
Mini-bar refrigerator · Refrigerador mini-bar

| Ref | € | W | Capacidad | Niveles temperatura | Consumo (g/h) | Ruido | Refrigerante | Medidas AxBxC | U.Venta |
|---------|--------|----|-----------|---------------------|---------------|-------------|--------------|-----------------|---------|
| A 69070 | 263,90 | 70 | 40L | 3 | 197 kWh/annum | 39 dB (máx) | R600a (27g) | 43 x 41 x 51 cm | 1 |
| B 69075 | 263,90 | 70 | 40L | 3 | 197 kWh/annum | 39 dB (máx) | R600a (27g) | 43 x 41 x 51 cm | 1 |

REFRIGERADOR TERMOELÉCTRICO: el control y regulación de la temperatura, dependerá de la temperatura ambiental del establecimiento
THERMOELECTRIC REFRIGERATOR: temperature control and regulation depend on the ambient temperature of the establishment

Máquinas de hielo

INOX     Professional use

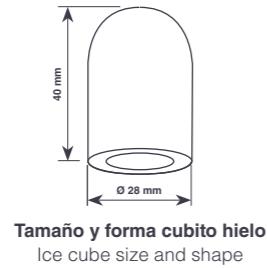
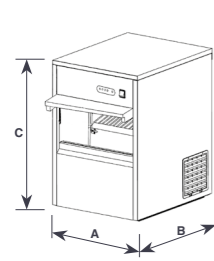

Tamaño y forma cubito hielo
Ice cube size and shape



Máquina de hielo Pro

Machine à fabriquer des glaçons · Eiswürfelmaschine
Ice maker · Máquina de gelo

| Ref | € | W | Capacidad hielo | Producción | Medidas AxBxC | U.Venta |
|-------|---------|-----|-----------------|------------|---------------|---------|
| 69320 | 1099,20 | 170 | 4kg | >20kg/24h | 38x48x59 cm | 1 |

En 10 o 12 minutos, obtendrá cubitos de hielo. Dispone de programador
In 10 to 12 minutes you will have ice cubes. It has a programmer



Máquina de hielo Ice

Machine à glaçons · Eiswürfelmaschine
Ice cubes maker · Máquina de fazer gelo

| Ref | € | W | Capacidad contenedor | Capacidad hielo | Producción | Medidas | U.Venta |
|-------|--------|-----|----------------------|-----------------|-------------|-------------|---------|
| 69314 | 424,60 | 150 | 1,5L | 600 g | 10-15kg/24h | 32x32x28 cm | 1 |

9 cubitos por ciclo (cada ciclo es de 8 min aproximadamente)
9 cubes per cycle (each cycle is approximately 8 min.)

Tamaño y forma cubito hielo
Ice cube size and shape

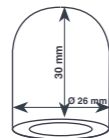

ABS PP
Plastic Polypropylene

Máquina de hielo Nord

Machine à glaçons · Eiswürfelmaschine
Ice cubes maker · Máquina de fazer gelo

| Ref | € | W | Capacidad contenedor | Capacidad hielo | Producción | Medidas | U.Venta |
|-------|--------|-----|----------------------|-----------------|------------|-------------|---------|
| 69340 | 277,50 | 100 | 2,2L | 700g | 12kg/24h | 36x24x33 cm | 1 |



Picadoras de hielo

INOX 18/10    Semiprofessional use



Micro-interruptor de seguridad
Safety micro-switch

Picadora de hielo Ice

Broyeur à glaçons · Eis-Crusher
Ice crusher · Picadora de gelo

| Ref | € | W | Capacidad | Velocidad | Producción | Medidas | U.Venta |
|-------|--------|------|-----------|------------|------------|---------------|---------|
| 69431 | 510,50 | 200W | 3 L | 1000 r.p.m | 90 kg/h | 33x18,5x53 cm | 1 |



Picadora de hielo Pro

Broyeur à glace · Eis-Crusher
Ice crusher · Picadora de gelo

| Ref | € | W | Capacidad | Flujo de masa (Kg/h) | Embudo | Medidas | U.Venta |
|-------|--------|---------|-----------|----------------------|--------|---------------|---------|
| 69313 | 116,70 | 60 - 80 | 2,8L | 12 kg/h | Ø14 cm | 17x29x47,5 cm | 1 |



Embudo de llenado extraíble
Removable cone



Picadora de hielo Marble

Broyeur à glaçons · Eis-Crusher
Ice crusher · Picadora de gelo

| Ref | € | W | Capacidad | Medidas | U.Venta |
|-------|-------|-----|-----------|-----------------|---------|
| 69310 | 88,20 | 100 | 0,5 L | 18x20,5x46,5 cm | 1 |



Máquina enfríacopas Freeze

INOX CE  Professional use

- Gracias a su diseño, la FREEZE es perfecta para cualquier local ya que se adapta a todo tipo de superficies, ocupando el mínimo espacio.
- Se puede ubicar donde se precise según las necesidades de cada ocasión.
- Perfecta para negocios de mucha actividad.
- Fabricado en acero inoxidable.
- Conexión a botella de CO2 de 28 ó 36 kg.
- Contador de operaciones.
- Luces tipo LED de activación por impulsos de gas.
- Sistema de conexión a botella con sistema de seguridad incluido.

- Grâce à sa conception, Freeze est parfait pour n'importe quel endroit car il s'adapte à tous les types de surfaces, occupant l'espace minimum.
- Il peut être localisé là où il est nécessaire en fonction des besoins de chaque occasion.
- Parfait pour beaucoup d'activité.
- En acier inoxydable.
- Connexion en bouteille de CO2 de 28 ou 36 kg.
- Compteur d'opérations.
- Lumières LED de l'activation de l'impulsion du gaz.
- Système de connexion à la bouteille avec système de sécurité inclus.

- Thanks to its design, Freeze is perfect for any place since it adapts to all types of surfaces, occupying the minimum space.
- It can be located where it is required according to the needs of each occasion.
- Perfect for a lot of activity.
- Made of stainless steel.
- CO2 bottle connection of 28 or 36 kg.
- Operations counter.
- LED lights of gas impulse activation.
- Bottle connection system with security system included.



Precios NO sujetos al sistema de descuentos habitual de LACOR
Prix non soumis au système habituel de remises de LACOR
Prices not subject to the usual discount system of LACOR

Máquina enfríacopas Freeze

Machine à givrer les verres · Gläser-Kühlmaschine
Glass cooler machine · Máquina para enfriar copas

| Ref | € | W | Programas | Medidas | U.Venta |
|-------|---------|----|-----------|-------------|---------|
| 69300 | 3241,20 | 25 | 4 | 23x31x50 cm | 1 |

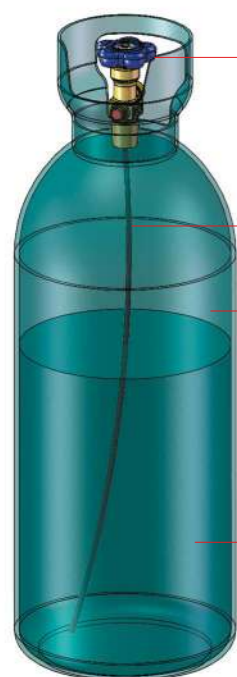

¿Qué tipo de gas utilizamos?

El gas que utilizan nuestras máquinas es Gas carbónico alimentario en estado líquido. El Dióxido de Carbono, también denominado óxido de carbono (IV), gas carbónico y anhídrido carbónico, CO₂, es insípido, incoloro, inodoro y no inflamable.

Aunque la forma más común en que se encuentra el CO₂ es en estado gaseoso, bajo determinadas condiciones se puede encontrar también en estado líquido o sólido. Estas botellas están destinadas para uso médico y alimentario y lo que las diferencia del resto es que en su interior cuenta con una sonda que extrae el líquido criogénico que al liberarse alcanza una temperatura de -79,8 C°

Seguridad LACOR

- 1.- Funcionamiento a base de gas carbónico líquido alimentario
- 2.- Control de presión de gas. Control de temperatura de congelación del gas ajustable de -8 a -55°C
- 3.- Fabricado en Acero Inoxidable de uso médico y alimentario. Todos los conductos interiores están fabricados en AISI-316 garantizando las óptimas condiciones alimentarias e higiénico-sanitarias
- 4.- Adaptable a cualquier tamaño de copa o vaso
- 5.- Exclusivo sistema de seguridad patentado y control para presiones superiores a 100 bar

Nuestros artículos cumplen las siguientes normativas:

- 1.- Directiva 2006/95/CE de seguridad eléctrica
- 2.- Directiva 2006/108/CE de compatibilidad electromagnética
- 3.- Directiva 2006/42/CE de máquinas
- 4.- Norma UNE-EN ISO 12100-1:2004
- 5.- Norma UNE-EN ISO 12100-2:2004
- 6.- Norma EN 614-1:1996
- 7.- Norma UNE-EN ISO 13850:2007
- 8.- Norma UNE-EN 60335-1

What type of gas do we use?

Our machines use liquid food grade Carbon dioxide gas. Carbon Dioxide, also called carbon oxide (IV), carbonic gas and carbon anhydride, CO₂, is insipid, colourless, odourless and not flammable.

Although the most common state of CO₂ is gaseous, under certain conditions it can also be found in liquid or solid state. These bottles are used for medical and food uses and they are different from the rest in that their interiors have a probe that extracts the cryogenic liquid which when freed reaches temperatures of -79.8 °C

LACOR Safety

- 1.- Operability based on liquid food grade carbon dioxide gas
- 2.- Control of gas pressure. Control of freezing temperature of the gas adjustable from -8 to -55 °C
- 3.- Manufactured from Stainless Steel for medical and food use. All the internal conducts are manufactured from AISI-316 guaranteeing optimal food and hygienic-health condition
- 4.- Adaptable to any size of glass
- 5.- Exclusive patented safety system and control for pressures above 100 bar

Our articles fulfill the following standards:

- 1.- Directive 2006/95/CE for electrical safety
- 2.- Directive 2004/108/EC for electromagnetic compatibility
- 3.- Directive 2006/42/CE for machinery
- 4.- UNE-EN ISO 12100-1:2004 Standard
- 5.- UNE-EN ISO 12100-2:2004 Standard
- 6.- EN 614-1:1996 Standard
- 7.- UNE-EN ISO 13850:2007 Standard
- 8.- UNE-EN 60335-1 Standard

Básculas profesionales

INOX CE  Professional use



Báscula industrial con base

Balance industrielle avec base · Industrieller Küchenwaage mit Sockel
Industrial scale with base · Balança industrial com base

| Ref | € | Tara | Medidas | Peso (g) | U.Venta |
|-------|---------|-------------|-----------------|----------|---------|
| 61700 | 1178,00 | 150kg (20g) | 49 x 75 x 90 cm | 45kg | 1 |

- Batería interna recargable (autonomía de 15 días).
- Visor de nivel, planitud.
- Avisador acústico de sobrecarga.
- Teclado intuitivo y de fácil uso. Funciones de calculadora.
- Acumulación de importes.
- Unidades de medida (Kg · oz · Libras). Función de tara.
- Libro de instrucciones en 7 idiomas.

- Batterie interne rechargeable (autonomie 15 jours).
- Indicateur de niveau, de planéité.
- Avertisseur acoustique de surcharge.
- Clavier intuitif d'utilisation facile. Fonctions de calculatrice.
- Accumulation de sommes
- Unités de mesure: (Kg · Oz · Livres). Fonction de tare
- Mode d'emploi en 7 langues

- Rechargeable internal battery (last 15 days).
- Level and fatness indicator.
- Overload alarm.
- Intelligent and easy-to-use keyboard. Calculator functions. Total counter.
- Measurement units: (Kg · Oz · pounds). Tare function
- Instructions book in 7 languages.



Báscula profesional electrónica

Balance électronique professionnelle · Elektronische Profi-Waagen
Electronic professional scale · Balança eletrónica profissional

| Ref | € | W | Tara | IP | Peso (Kg) | U.Venta |
|-------|--------|-------|----------|--------|-----------|---------|
| 61716 | 485,10 | 0,2 W | 15kg/5g | IPX 54 | 4,60kg | 1 |
| 61730 | 522,00 | 0,2 W | 30kg/10g | IPX 54 | 4,60 kg | 1 |

- Batería interna recargable (autonomía de 15 días).
- Visor de nivel, planitud.
- Avisador acústico de sobrecarga.
- Teclado intuitivo y de fácil uso. Funciones de calculadora.
- Acumulación de importes.
- Unidades de medida (Kg · oz · Libras). Función de tara.
- Libro de instrucciones en 7 idiomas.

- Batterie interne rechargeable (autonomie 15 jours).
- Indicateur de niveau, de planéité.
- Avertisseur acoustique de surcharge.
- Clavier intuitif d'utilisation facile. Fonctions de calculatrice.
- Accumulation de sommes
- Unités de mesure: (Kg · Oz · Livres). Fonction de tare
- Mode d'emploi en 7 langues

- Rechargeable internal battery (last 15 days).
- Level and fatness indicator.
- Overload alarm.
- Intelligent and easy-to-use keyboard. Calculator functions. Total counter.
- Measurement units: (Kg · Oz · pounds). Tare function
- Instructions book in 7 languages.

Pizarra eléctrica



- **Llamativo sistema de promoción. Gran impacto visual.**
- **Ideal para cualquier tipo de establecimiento: restaurantes, cafeterías, pubs, tiendas de alimentación, etc.**
- **Diseñadas para colocarlas tanto vertical como horizontalmente gracias a la cadena suministrada**
- **Uso similar de las pizarras normales, se escribe sobre la superficie (cristal templado) con rotuladores fluorescentes (Ref.:39161) y se borra con una simple bayeta de fibra.**
- **Realice el dibujo en la pizarra totalmente desenchufada.**

- **Système de promotion accrocheur. Grand impact visuel.**
- **Idéal pour tout type d'établissement : restaurants, cafés, pubs, magasins d'alimentation, etc.**
- **Conçu pour être placé aussi bien à la verticale qu'à l'horizontale, grâce à la chaîne fournie.**
- **Semblables à des tableaux normaux, ils permettent d'écrire sur la surface (verre trempé) avec des marqueurs fluorescents (Ref.:39161) et essuyés avec un simple chiffon en fibre.**
- **Dessinez sur le tableau complètement débranché.**

- **Eye-catching promotion system. Great visual impact.**
- **Ideal for any type of establishment: restaurants, cafés, pubs, food shops, etc.**
- **Designed to be placed both vertically and horizontally, thanks to the supplied chain**
- **Similar to normal blackboards, they are used for writing on the surface (tempered glass) with fluorescent markers (Ref.:39161) and wiped off with a simple fibre cloth.**
- **Draw on the blackboard completely unplugged.**



Pizarra Led
Tableau lumineux à LED · LED Tafel
Blackboard LED · Ardósia LED

| Ref | € | W | Funciones | Medidas | U.Venta |
|---------|--------|---|-----------|----------|---------|
| A 39140 | 105,50 | 2 | 38 | 40x60 cm | 1 |
| B 39160 | 144,80 | 2 | 38 | 60x80 | 1 |



Rotuladores fluorescentes 8 colores

Marqueurs fluorescents 8 couleurs · 8-Farben fluoreszierenden marker
Fluorescent markers 8 colors · Maracadores fluorescentes 8 cores

| Ref | € | cm | U.Venta |
|-------|-------|----|---------|
| 39161 | 34,10 | 10 | 1 |

Afiladores eléctricos



- **Permite mantener los utensilios en perfecto estado.**
- **Diseño elegante, acabado metalizado.**
- **Dispone de diferentes ranuras para poder afilar distintos tipos de utensilios como cuchillos, tijeras o destornilladores de punta plana.**
- **El motor gira a la velocidad óptima para que el afilado de los utensilios sea preciso y duradero.**
- **100% seguro: en su base se incluyen cuatro ventosas de fijación para evitar que el afilador se mueva durante su uso.**

- **Vous permet de garder les ustensiles en parfait état.**
- **Design élégant, finition métallique.**
- **Il a des rainures différentes pour pouvoir affiner différents types d'ustensiles tels que des couteaux, des ciseaux ou des tournevis sur la pointe plate.**
- **Le moteur tourne à la vitesse optimale de sorte que l'affûtage des ustensiles est précis et durable.**
- **100% sûr: quatre tasses de ventouses à fixation sont incluses pour empêcher le hauteur de se déplacer pendant l'utilisation.**

- **Allows you to keep utensils in perfect condition.**
- **Elegant design, metallic finish.**
- **It has different grooves to be able to sharpen different types of utensils such as knives, scissors or screwdrivers on the flat tip.**
- **The engine revolves at the optimal speed so that the sharpening of the utensils is precise and lasting.**
- **100% safe: four fixing suction cups are included to prevent the sharpener from moving during use.**



Afilador de cuchillos Rond

Affûteuse de couteaux électrique · Elektrische Schärmaschine
Electric knife sharpener · Afiador de facas electrónico

| Ref | € | W | Medidas | U.Venta |
|-------|-------|----|-------------|---------|
| 69141 | 33,00 | 60 | 14x14x10 cm | 1 |

- Fase 1:**
Alta abrasividad · High abrasiveness
- Fase 2:**
Afilado fino · Thin sharp
- Fase 3:**
Microafilado · Micro-sharp



Afilador de cuchillos Pro

Affûteuse de couteaux électrique · Elektrische Schärmaschine
Electric knife sharpener · Afiador de facas electrónico

| Ref | € | W | Medidas | U.Venta |
|-------|--------|-----|-------------|---------|
| 69261 | 127,60 | 180 | 32x12x11 cm | 1 |



Afilador de cuchillos TitanPro

Affûteuse de couteaux électrique · Elektrische Schärmaschine
Electric knife sharpener · Afiador de facas electrónico

| Ref | € | W | Medidas | U.Venta |
|-------|-------|----|------------|---------|
| 69341 | 40,20 | 60 | 17x8x10 cm | 1 |



Afilador de cuchillos Mouse

Affûteuse de couteaux électrique · Elektrische Schärmaschine
Electric knife sharpener · Afiador de facas electrónico

| Ref | € | W | Medidas | U.Venta |
|-------|-------|-----|------------|---------|
| 60359 | 50,40 | 180 | 16x10x7 cm | 1 |



Afilador de cuchillos Drei

Affûteuse de couteaux · Schärmaschine
Knife sharpener · Afiador de facas

| Ref | € | cm | h(cm) | W | Velocidad (r.p.m.) | U.Venta |
|-------|--------|-----------|-------|----|--------------------|---------|
| 69432 | 102,60 | 26,5x10,7 | 9,5 | 18 | 2800 | 1 |

- **Diseñado para afilar cuchillos de acero inoxidable (lisos y dentados) y cuchillos de cerámica. Ángulo de afilado de 20°.**
- **Sistema basado en 3 etapas: grueso, fino y pulido.**
- **Efficiente y potente: equipado con un motor de 18 W de corriente continua y una rotación de alta velocidad de 2800 r.p.m.**
- **Rodillo con recubrimiento 100% de diamante en ranura gruesa (grano 360), abrasivos de diamante en ranura fina (grano 600) y resina de alta tecnología en ranura de pulido (grano 1000). Afilado rápido y seguro.**
- **Base magnética que recoge las partículas de material metálico desbastado.**
- **Base antideslizante: garantiza la estabilidad durante el uso.**

- **Designed for sharpening stainless steel (smooth and serrated) and ceramic knives. 20-degree sharpening angle.**
- **3-stage sharpening system: coarse, fine and polish.**
- **Efficient and powerful: equipped with an 18 W DC, 2800 RPM high speed motor.**
- **Roller with 100% diamond coating in the coarse slot (360 grit), diamond abrasives in the fine slot (600 grit) and high-tech resin in the polishing slot (1000 grit). Quick, safe sharpening.**
- **Magnetic base to collect metal shavings after the sharpening process.**
- **Non-slip base for optimum stability during use.**

Esterilizador de cuchillos

INOX CE  Professional use

- Esterilización mediante rayos ultravioletas germicidas que transforman el oxígeno en ozono, destruyendo bacterias, hongos y virus.
- Ideal para la restauración.

- La stérilisation par des rayons germicides ultraviolets qui transforment l'oxygène en ozone, détruisant les bactéries, les champignons et les virus.
- Idéal pour la restauration.

- Sterilization by ultraviolet germicidal rays that transform oxygen into ozone, destroying bacteria, fungi and viruses.
- Ideal for restoration.



IP21

Esterilización mediante rayos ultravioletas germicidas que transforman el oxígeno en ozono, destruyendo bacterias, hongos y virus.

Sterilisation by ultraviolet germicidal rays that transform oxygen into ozone, destroying bacteria, fungi and viruses.

Esterilizador de cuchillos

Armoire à stériliser · Sterilisierungsschank
Knife sterilization · Armário esterilizador facas

| Ref | € | W | Cuchillos | Tiempo | Medidas | U.Venta |
|----------------|---------------|----|-----------|---------|-------------|---------|
| A 39012 | 674,00 | 15 | 10 | 120 min | 36x13x57 cm | 1 |
| B 39124 | 903,50 | 15 | 20 | 120 min | 45x13x57 cm | 1 |



Matamosquitos

CE  Professional use

Sin descargas eléctricas
Doesn't produce electric shocks



* Se recomienda reemplazar el papel adhesivo cada 10 días pero si más de 2/3 del papel está cubierto de moscas, reemplace el papel
It is recommended that you replace the sticky fly paper every 10 days but if more than 2/3 of the paper is covered in flies, replace the paper

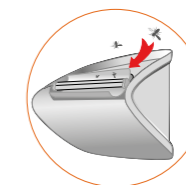

ABS
Plastic

Matamosquitos Decor
Anti-moustiques · Fliegenfänger
Mosquito killer · Mata mosquitos

| Ref | € | W | Número de lámparas | Área de protección | Medidas | U.Venta |
|-------|---------------|----|--------------------|--------------------|-----------------|---------|
| 39135 | 105,30 | 35 | 2 | 60 m2 | 42x23,8x17,3 cm | 1 |

Set de 3 láminas adhesivas

Ensemble de 3 feuilles adhesives · Set von 3 Klebe Folie
Set of 3 adhesives sheet · Conjunto de 3 folhas adesivas

| Ref | € | U.Venta |
|---------|--------------|---------|
| R39135C | 13,70 | 1 |



Vida útil de trabajo: 10.000 h
Useful working life: 10,000 h

Incluye cuerda para colgar
Includes a cord for hanging

PP
Polypropylene

Matamosquitos White
Anti-moustiques · Mückenfalle
Mosquito killer · Mata-mosquitos

| Ref | € | W | Número de lámparas | Área de protección | Descargas | Vida útil | Medidas | U.Venta |
|-------|--------------|-----|--------------------|--------------------|-----------|-----------|--------------|---------|
| 39129 | 66,70 | 3,5 | 2 | 50 m2 | 2500 V | 10,000 h | 36x36x8,3 cm | 1 |



new



- Diseñado para uso interior: hogar, oficinas, hoteles, locales comerciales, restaurantes, etc.
- Dispone de una lámpara LED de alta calidad y con una longitud de onda óptima para atraer a todo tipo de insectos voladores.
- Una alternativa perfecta a los insecticidas, libre de contaminación e inocuo para los humanos.
- Dispone de rejilla metálica de 2500V en el interior donde los insectos son electrocutados.
- Vida útil de trabajo: 20.000 h.
- Limpieza interior automática cada 4 horas.
- Bandeja extraíble para una fácil limpieza.
- Tiene una longitud de cable de un metro de largo.
- Diseñado para 100 m2 aproximadamente.
- Fácil instalación: podrá colocarlo en la pared (accesorios incluidos) o sobre cualquier encimera, mesa o incluso el suelo

- Conçu pour une utilisation en intérieur : logements, bureaux, hôtels, boutiques, restaurants, etc.
- Dispose de une ampoule LED de grande qualité et d'une longueur d'onde optimale pour attirer tout type d'insectes volants.
- Une alternative parfaite aux insecticides, sans contamination et inoffensive pour les humains
- Dispose d'une grille métallique de 2500V à l'intérieur, où les insectes sont électrocutés.
- Durée de vie : 20 000 h.
- Nettoyage automatique de l'intérieur toutes les 4 heures
- Plateau extractible pour faciliter le nettoyage.
- Installation facile. Inclut une corde pour l'accrocher.
- Conçu pour une surface de 100 m2 environ.
- Installation facile : vous pouvez le placer au mur (accessoires inclus) ou sur un plan de travail, une table ou même le sol

- Designed for indoor use: Home, offices, hotels, businesses, restaurants, etc.
- It has one high quality LED light with an optimal wavelength for attracting all kinds of flying insects.
- It's a perfect alternative to insecticide because it's pollution free and innocuous to humans.
- It has a 2500 V metal screen inside where insects are electrocuted.
- Useful working life: 20,000 h.
- Automatic interior cleaning every 4 hours
- Removable tray for easy cleaning.
- Easy to install Includes a cord for hanging.
- Designed for approximately 100 m2.
- Easy installation: you can place it on the wall (accessories included) or on any worktop, table or even the floor.

Matamosquitos Limpo

Anti-moustiques électrique · Elektrofliegenfänger
Electric mosquito killer · Mata mosquitos eléctrico

| Ref | € | W | Área de protección | U.Venta |
|-------|-------|----|--------------------|---------|
| 39132 | 79,90 | 12 | 100 m2 | 1 |

Soporte colgador
Luz ultravioleta
Bandeja recoge mosquitos
Hanger support
Ultraviolet light
Tray collection mosquitoes

Matamosquitos Net

Appareil anti-moustiques noir · Fliegenfänger, schwarz
Moskito killer black · Mata mosquitos preto

| Ref | € | W | Área de protección | Número de lámparas | Medidas | U.Venta |
|---------|-------|---|--------------------|--------------------|-----------------|---------|
| A 39138 | 21,50 | 4 | 40 m2 | 1 | 12 x 12 x 25 cm | 1 |
| B 39139 | 24,20 | 6 | 60 m2 | 1 | 12 x 12 x 32 cm | 1 |

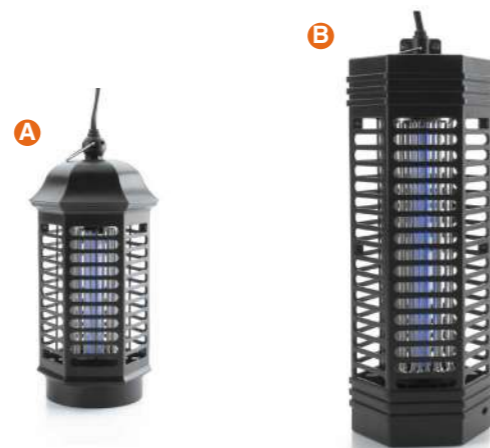

Vida útil de trabajo
Functional lifespan
20.000 h



ABS
Plastic

Matamosquitos Luce

Anti-moustiques · Fliegenfänger
Moskito killer · Mata mosquitos

| Ref | € | W | Área de protección | Bombillas | Descargas | Medidas | U.Venta |
|---------|--------|----|--------------------|-------------|-----------|---------------------|---------|
| A 39126 | 92,80 | 11 | 150 m2 | 16-UV-A LED | 4000V | 34,5 x 10 x 26,5 cm | 1 |
| B 39127 | 113,50 | 13 | 300 m2 | 20 UV-A LED | 4000V | 49 x 10 x 26,5 cm | 1 |

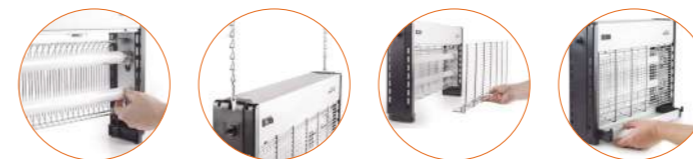

Protección
Protection
IPX0



ABS
Plastic

Matamosquitos Capter

Anti-moustiques · Fliegenfänger
Moskito killer · Mata mosquitos

| Ref | € | W | Área de protección | Bombillas | Medidas | U.Venta |
|---------|-------|----|--------------------|----------------|---------------|---------|
| A 39134 | 77,00 | 26 | 80 m2 | 2X10W UV-A LED | 59x49x41 cm | 1 |
| B 39136 | 86,20 | 36 | 100 m2 | 2X10W UV-A LED | 64x49x40,5 cm | 1 |



Calentadores de exterior

AL Aluminium Professional use

- Desmontable en 3 partes: facilita el almacenaje de larga duración.
- El cabezal del calentador tiene un radio de giro de 40°.
- Base redonda y pesada para una mejor estabilidad y seguridad.
- Seguro y respetuoso con el medio ambiente, no produce ni ruidos ni olores.
- Incluye unos accesorios para el anclaje del calefactor.

- Amovible en 3 parties: facilite le stockage à long terme.
- La tête de chauffage a un rayon de virage de 40°.
- Base ronde et lourde pour une meilleure stabilité et sécurité.
- Sûr et respectueux de l'environnement, ne produit pas de bruit ou d'odeurs.
- Comprend des accessoires pour l'ancre chauffage.

- Removable in 3 parts: facilitates long-term storage.
- The heater head has a 40° turn radius.
- Round and heavy base for better stability and safety.
- Safe and environmental respectful, does not produce noise or odors.
- Includes accessories for heating anchor.

¿Qué es la clasificación IP? · What is the IP classification?

IP54

| 1º dígito; protección contra objetos y polvo 1st digit; protection against objects and dust | 2º dígito; protección contra líquidos 1st digit; protection against liquids |
|--|---|
| IP0: Sin protección · Without protection | IPX0: Sin protección · Without protection |
| IP1: Protección contra objetos con un Ø mayor de 50 mm Protection against objects with Ø greater than 50 mm | IPX1: Protección contra gotas de agua Protection against water drops |
| IP2: Protección contra objetos con un Ø mayor a 12 mm Protection against objects with Ø greater than 12 mm | IPX2: Protección contra el goteo de agua con una inclinación de 15° · Protection against dripping water with an inclination of 15° |
| IP3: Protección contra objetos con un Ø mayor a 2,5 mm Protection against objects with Ø greater than 2,5 mm | IPX3: Protección contra pulverización Protection against spray |
| IP4: Protección contra objetos con un Ø mayor a 1 mm Protection against objects with Ø greater than 1 mm | IPX4: Protección contra salpicaduras · Splash protection |
| IP5: Protección contra polvo · Protection against dust | IPX5: Protección contra chorros de agua Protection against water jets |
| IP6: A prueba de polvo · Testing against dust | IPX6: Protección contra aguaceros Protection against downpours |
| | IPX7: Protección contra la inmersión durante un tiempo determinado · Protection against immersion for a certain time |
| | IPX8: Protección contra permanencia bajo agua Protection against permanence under water |

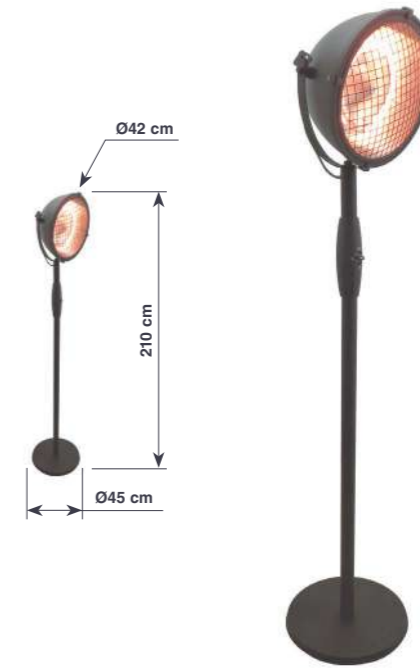
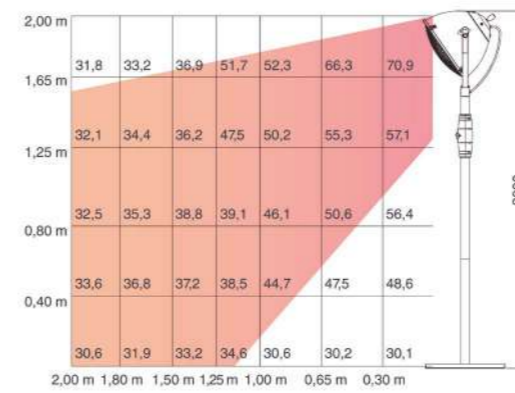

Rejilla protectora
Protective grill



Selector nivel de calentamiento
Heating level selector



AL Aluminium

Calentador eléctrico de pie Black
Chauffage électrique sur pied · Standheizstrahler
Free standing electric heater · Aquecedor eléctrico de pé

| Ref | € | W | Calentamiento | Protección | Medidas | U.Venta |
|-------|--------|------|----------------|------------|-----------------|---------|
| 69414 | 467,30 | 2100 | 900-1200-2100W | IP54 | 45,2x45,2x209cm | 1 |

Área de calentamiento · Heating area

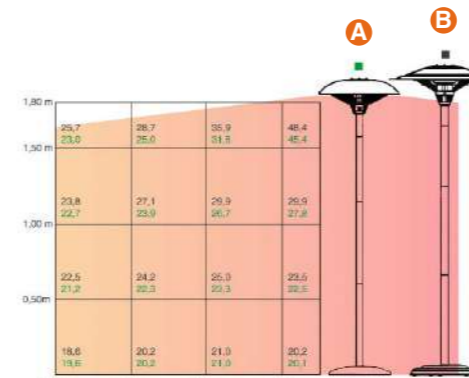

AL INOX Aluminium

Calentador eléctrico de pie Inox
Rechauffeur pied · Heizung m/Ausziehbarer Fuß
Lamp · Aquecedor com pé

| Ref | € | W | Protección | Altura máxima | Medidas | U.Venta |
|---------|--------|----------------|------------|---------------|--------------------|---------|
| A 69410 | 353,30 | 2100 W | IP44 | 2,10 m | 58,5 x 1,6-2,10 cm | 1 |
| B 69411 | 418,80 | 1200/1800/3000 | IP44 | 2,10 m | 76 x 76 x 210 cm | 1 |



Cadena de 1 m de longitud
1 m long chain

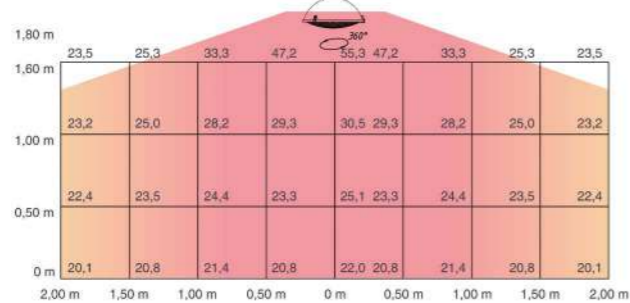

AL
Aluminium

Lampara calentadora de techo

Parasol chauffant électrique suspendu · Elektrischer Deckenheizstrahler
Electric hanging lamp heater · Candeeiro aquecedor elétrico de teto

| Ref | € | W | Número de lámparas | Calentamiento | Protección | Medidas | U.Venta |
|-------|--------|------|--------------------|-----------------|------------|-------------------|---------|
| 69422 | 215,50 | 2100 | 2 | 900-1200-2100 W | IP44 | 43 x 43 x 36,4 cm | 1 |

Área de calentamiento · Heating area

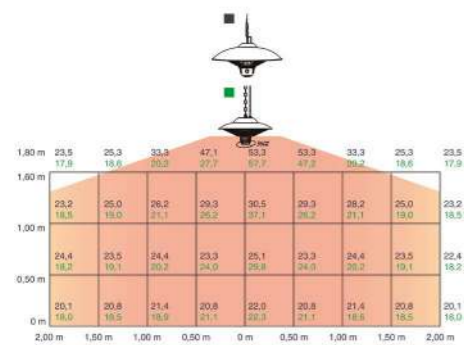

AL
Aluminium

Lámpara calentador

Lampe chauffe · Heizelement, freihängend
Lamp · Lâmpada aquecedora

| Ref | € | W | Protección | Calentamiento | Medidas | U.Venta |
|---------|--------|---------------|------------|----------------------|---------------------|---------|
| A 69420 | 180,70 | 1500 | IP24 | Infrarrojos/infrared | 42 x 26 cm | 1 |
| B 69421 | 243,40 | 900/1200/1500 | IP24 | Infrarrojos/infrared | 58,5 x 58,5 x 35 cm | 1 |

Área de calentamiento · Heating area

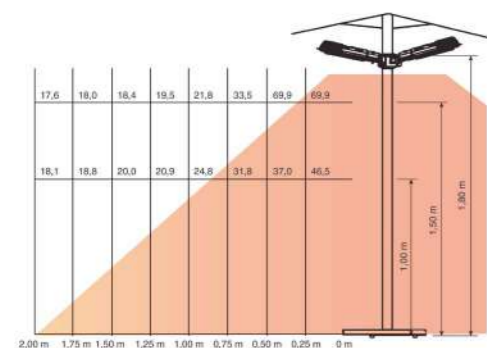

Max: Ø6 cm
Min: Ø2, 5 cm



Calentador con brazos abatibles

Lampe chauffege bras rebatibles · Heizgerät Arme ausklappbar
Heating lamp arms fold-away · Aquecedora braços rebatíveis

| Ref | € | W | Protección | Calentamiento | Medidas | U.Venta |
|-------|--------|------|------------|----------------------|---------------------|---------|
| 69423 | 240,40 | 2000 | IP24 | Infrarrojos/infrared | 100 x 100 x 10,3 Kg | 1 |



Soporte extendido
Extended support

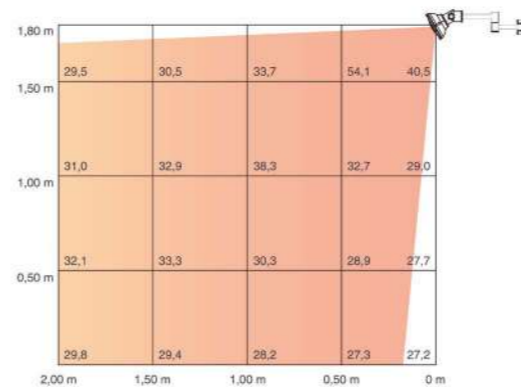

AL
Aluminium

Calentador de pared

Chauffe de mur · Heizung, Hängeleiste
Wall lamp · Aquecedora de parede

| Ref | € | W | Calentamiento | Protección | Medidas | U.Venta |
|-------|--------|------|---------------|------------|-----------------|---------|
| 69424 | 313,00 | 1500 | 1 | IP55 | 75 x 13 x 14 cm | 1 |

Rejilla protectora
Incluye un soporte de pared con regulación angular
Cuerpo de aleación de aluminio anodizado
Calefactor de fibra de carbono de alta eficiencia
Protective grill
Includes a wall bracket with angular adjustment
Anodized aluminum alloy body.
High Efficiency Carbon Fibre Heating



AL ABS
Aluminium Plastic

Calentador de pared Sun

Chauffe de mur · Heizung, Hängeleiste
Wall lamp · Aquecedora de parede

| Ref | € | W | Niveles calentamiento | Protección | Número de lámparas | Medidas | U.Venta |
|-------|--------|------|-----------------------|------------|--------------------|---------------------|---------|
| 69425 | 206,80 | 1800 | 1 | IP65 | 1 | 65 x 21,5 x 24,5 cm | 1 |
| 69426 | 242,80 | 2400 | 1 | IP65 | 1 | 85 x 22,6 x 26,6 cm | 1 |



Con control remoto
With remote control

Accesorios · Accessoires · Accessories



Base con contrapeso
Counterbalanced base

Soporte calentador Sun

Support pour chauffe · Heizungshalterung
Support for lamp · Suporte para aquecedora

| Ref | € | Ø (cm) | h(cm) | U.Venta |
|-------|-------|--------|-------|---------|
| 69427 | 75,10 | 40 | 190 | 1 |

Solo para uso en exteriores · Only for outdoor use

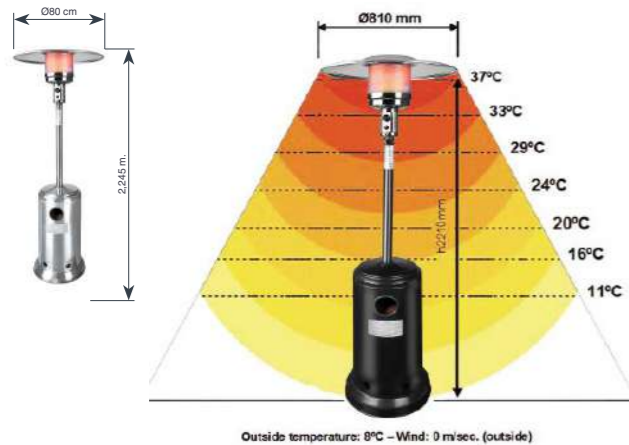

- Ideal para bares y restaurantes con mesas en el exterior.
- Indicado única y exclusivamente para exteriores.
- Disponible en dos acabados diferentes: acero inoxidable · negro.
- Malla protectora para evitar quemadura.

- Idéal pour les bars et les restaurants ayant des tables à l'extérieur.
- Destiné uniquement et exclusivement pour un usage en extérieur.
- Disponible en deux finitions différentes : acier inoxydable · noir.
- Maille de protection pour éviter les brûlures.

- Ideal for bars and restaurants with tables outside.
- Exclusively for outdoor use.
- Available in two different finishes: stainless steel · black.
- Protective mesh to prevent burns.

Accesorios · Accessoires · Accessories



Funda para calentador de terraza

Housse pour chauffage de terrasse à gaz
Abdeckung für Gas-Terrassenheizstrahler
Cover for outdoor gas heater
Capa protectora para aquecedor a gás para terraços

| Ref | € | U.Venta |
|---------|-------|---------|
| R69400N | 17,80 | 1 |



Ruedas para calentador de terraza

Ensemble de roves pour chauffage de terrasse à gaz
Rollen für Gas-Terrassenheizstrahler
Wheel set for outdoor gas heater
Jogo de rodas para aquecedor a gás para terraços

| Ref | € | U.Venta | |
|------------------|-------|---------|-------|
| A R69400B | 11,40 | 1 | Inox |
| B R69400R | 11,40 | 1 | Black |

Calentador terraza gas

Chauffage de terrasse à gaz · Gas-Terrassenheizstrahler
Outdoor gas heater · Aquecedor a gás para terraços

| Ref | € | W | Niveles calentamiento | Consumo (g/h) | Medidas | U.Venta |
|----------------|--------|-------|-----------------------|---------------|--------------------|---------|
| A 69400 | 403,80 | 14 kW | Regulable | 450-870 g/h | 80 x 80 x 224,5 cm | 1 |
| B 69401 | 305,50 | 14 kW | Regulable | 450 - 870 g/h | 80 x 80 x 224,5 cm | 1 |

Índice
·
Sommaire
·
Index
·
Index
·
Índice

| Ref. | Pag. | Ref. | Pag. | Ref. | Pag. | Ref. | Pag. | Ref. | Pag. | Ref. | Pag. | Ref. | Pag. | Ref. | Pag. | Ref. | Pag. | Ref. | Pag. | Ref. | Pag. | Ref. | Pag. |
|-------|------|-------|------|-------|------|--------|------|-------|------|--------|------|-------|------|-------|------|-------|------|-------|------|-------|------|-------|------|
| 10330 | 452 | 14594 | 83 | 16128 | 29 | 20224 | 31 | 20660 | 109 | 23432 | 81 | 24347 | 94 | 25846 | 252 | 26724 | 96 | 27820 | 91 | 28205 | 367 | 32128 | 54 |
| 10430 | 452 | 14598 | 83 | 16132 | 29 | 20225 | 31 | 20716 | 31 | 23436 | 81 | 24720 | 98 | 25847 | 252 | 26726 | 96 | 27820 | 59 | 28206 | 367 | 32129 | 54 |
| 11330 | 452 | 14718 | 82 | 16136 | 29 | 20228 | 31 | 20720 | 31 | 23540A | 115 | 24722 | 98 | 25848 | 252 | 26728 | 96 | 27824 | 91 | 28211 | 382 | 32214 | 54 |
| 11430 | 452 | 14720 | 82 | 16140 | 29 | 20229 | 31 | 20830 | 72 | 23550A | 115 | 24724 | 98 | 25849 | 252 | 26730 | 96 | 27824 | 59 | 28212 | 382 | 32216 | 54 |
| 14012 | 259 | 14722 | 82 | 16212 | 29 | 20470 | 32 | 20840 | 72 | 23612 | 85 | 24726 | 98 | 25850 | 252 | 26816 | 95 | 27827 | 91 | 28213 | 382 | 32218 | 54 |
| 14013 | 261 | 14724 | 82 | 16214 | 29 | 20511 | 73 | 20850 | 72 | 23614 | 85 | 24728 | 98 | 25851 | 252 | 26818 | 95 | 27827 | 59 | 28311 | 379 | 32220 | 54 |
| 14016 | 320 | 14726 | 82 | 16216 | 29 | 20515 | 73 | 20920 | 32 | 23616 | 84 | 24732 | 98 | 25852 | 252 | 26820 | 95 | 27828 | 91 | 28321 | 376 | 32318 | 55 |
| 14016 | 177 | 14728 | 82 | 16218 | 29 | 20518 | 73 | 20924 | 32 | 23618 | 84 | 24918 | 99 | 25853 | 252 | 26822 | 95 | 27828 | 59 | 28331 | 373 | 32324 | 55 |
| 14019 | 320 | 14732 | 82 | 16220 | 29 | 20522 | 73 | 20928 | 32 | 23620 | 84 | 24920 | 99 | 25857 | 252 | 26824 | 95 | 27832 | 91 | 28332 | 373 | 32420 | 55 |
| 14019 | 177 | 14736 | 82 | 16224 | 29 | 20533 | 73 | 20930 | 32 | 23622 | 84 | 24922 | 99 | 25858 | 252 | 26826 | 95 | 27832 | 59 | 28333 | 373 | 32424 | 55 |
| 14025 | 320 | 14740 | 82 | 16624 | 29 | 20540 | 73 | 20932 | 32 | 23624 | 84 | 24924 | 99 | 25859 | 252 | 26828 | 95 | 27920 | 57 | 28341 | 372 | 32520 | 55 |
| 14025 | 177 | 14790 | 83 | 16628 | 29 | 20540A | 32 | 20934 | 32 | 23625 | 85 | 24926 | 99 | 25862 | 159 | 26830 | 95 | 27924 | 57 | 28342 | 372 | 32524 | 55 |
| 14027 | 230 | 14792 | 83 | 16632 | 29 | 20540A | 114 | 20936 | 32 | 23626 | 84 | 24928 | 99 | 25863 | 159 | 26832 | 95 | 27928 | 57 | 28343 | 372 | 32624 | 55 |
| 14029 | 320 | 14794 | 83 | 16636 | 29 | 20540F | 32 | 20938 | 32 | 23628 | 84 | 25144 | 94 | 25867 | 251 | 26834 | 95 | 28001 | 382 | 28351 | 377 | 32628 | 55 |
| 14029 | 177 | 14798 | 83 | 16640 | 29 | 20540F | 114 | 20940 | 32 | 23629 | 85 | 25148 | 94 | 25871 | 250 | 26838 | 95 | 28002 | 382 | 28352 | 377 | 32714 | 55 |
| 14033 | 320 | 14818 | 82 | 16920 | 29 | 20545A | 32 | 20945 | 32 | 23632 | 84 | 25154 | 94 | 25872 | 250 | 26844 | 95 | 28003 | 382 | 28353 | 377 | 32716 | 55 |
| 14033 | 177 | 14820 | 82 | 16924 | 29 | 20545A | 114 | 20950 | 32 | 23636 | 84 | 25158 | 94 | 25873 | 250 | 26848 | 95 | 28011 | 380 | 28371 | 374 | 32916 | 55 |
| 14040 | 320 | 14822 | 82 | 16928 | 29 | 20545F | 32 | 20960 | 32 | 23637 | 85 | 25160 | 64 | 25874 | 250 | 26858 | 95 | 28012 | 380 | 28372 | 374 | 32920 | 55 |
| 14040 | 177 | 14824 | 82 | 16932 | 29 | 20545F | 114 | 21216 | 31 | 23638 | 85 | 25160 | 249 | 25875 | 251 | 27018 | 97 | 28013 | 380 | 28373 | 374 | 32924 | 55 |
| 14042 | 230 | 14826 | 82 | 16936 | 29 | 20550 | 73 | 21220 | 31 | 23640 | 84 | 25161 | 65 | 25876 | 251 | 27020 | 97 | 28021 | 374 | 28375 | 374 | 32928 | 55 |
| 14046 | 320 | 14828 | 82 | 16940 | 29 | 20550A | 32 | 21224 | 31 | 23641 | 85 | 25161 | 249 | 25877 | 251 | 27022 | 97 | 28022 | 374 | 28376 | 374 | 33101 | 226 |
| 14046 | 177 | 14832 | 82 | 20020 | 30 | 20550A | 114 | 21228 | 31 | 23724 | 85 | 25162 | 65 | 25881 | 250 | 27024 | 97 | 28023 | 374 | 28411 | 372 | 33102 | 226 |
| 14049 | 320 | 14836 | 82 | 20021 | 30 | 20550F | 32 | 21524 | 81 | 23724 | 109 | 25162 | 249 | 25882 | 250 | 27026 | 97 | 28031 | 375 | 28412 | 372 | 33103 | 226 |
| 14049 | 177 | 14840 | 82 | 20024 | 30 | 20550F | 114 | 21528 | 81 | 23728 | 85 | 25163 | 65 | 25882 | 250 | 27028 | 97 | 28032 | 375 | 28413 | 372 | 33104 | 226 |
| 14050 | 230 | 15302 | 395 | 20025 | 30 | 20551 | 32 | 21618 | 81 | 23728 | 109 | 25163 | 249 | 25883 | 250 | 27030 | 97 | 28033 | 375 | 28431 | 372 | 33105 | 226 |
| 14065 | 261 | 15304 | 395 | 20028 | 30 | 20555A | 32 | 21620 | 81 | 23732 | 85 | 25164 | 64 | 25909 | 249 | 27032 | 97 | 28041 | 375 | 28432 | 372 | 33106 | 226 |
| 14100 | 231 | 15306 | 395 | 20029 | 30 | 20555A | 114 | 21622 | 81 | 23732 | 109 | 25164 | 249 | 25910 | 249 | 27134 | 97 | 28051 | 377 | 28433 | 372 | 33107 | 226 |
| 14114 | 178 | 15316 | 395 | 20030 | 30 | 20555F | 32 | 21624 | 81 | 23736 | 85 | 25432 | 93 | 25911 | 249 | 27138 | 97 | 28052 | 377 | 28451 | 367 | 33108 | 226 |
| 14119 | 178 | 15320 | 395 | 20031 | 30 | 20555F | 114 | 21626 | 81 | 23736 | 109 | 25432 | 108 | 25912 | 249 | 27144 | 97 | 28053 | 377 | 28452 | 367 | 33109 | 226 |
| 14121 | 299 | 15324 | 395 | 20032 | 30 | 20560A | 32 | 21628 | 81 | 23740 | 85 | 25436 | 93 | 25914 | 249 | 27148 | 97 | 28061 | 379 | 28453 | 367 | 33121 | 402 |
| 14122 | 149 | 15365 | 395 | 20033 | 30 | 20560A | 114 | 21632 | 81 | 23740 | 109 | 25436 | 108 | 25915 | 249 | 27158 | 97 | 28062 | 379 | 28500 | 381 | 33124 | 402 |
| 14124 | 178 | 15416 | 395 | 20034 | 30 | 20560F | 32 | 21636 | 81 | 23816 | 84 | 25440 | 93 | 25916 | 63 | 27320 | 57 | 28063 | 379 | 28501 | 381 | 33125 | 402 |
| 14125 | 149 | 15420 | 395 | 20035 | 30 | 20560F | 114 | 21640 | 81 | 23818 | 84 | 25440 | 108 | 25917 | 63 | 27324 | 57 | 28081 | 381 | 28502 | 381 | 33126 | 402 |
| 14128 | 178 | 15424 | 395 | 20036 | 30 | 20561 | 32 | 21718 | 81 | 23820 | 84 | 25534 | 115 | 25920 | 63 | 27327 | 57 | 28082 | 381 | 28510 | 375 | 33401 | 226 |
| 14130 | 149 | 15465 | 395 | 20037 | 30 | 20565A | 32 | 21720 | 81 | 23822 | 84 | 25536 | 93 | 25921 | 63 | 27328 | 57 | 28083 | 381 | 28511 | 375 | 33402 | 226 |
| 14135 | 231 | 15516 | 395 | 20038 | 30 | 20565A | 114 | 21722 | 81 | 23824 | 84 | 25539 | 115 | 25924 | 63 | 27416 | 57 | 28101 | 380 | 28512 | 375 | 33403 | 226 |
| 14136 | 231 | 15520 | 395 | 20039 | 30 | 20565F | 32 | 21724 | 81 | 23826 | 84 | 25547 | 93 | 25925 | 63 | 27418 | 57 | 28102 | 380 | 28530 | 377 | 33404 | 226 |
| 14145 | 231 | 15524 | 395 | 20040 | 30 | 20565F | 114 | 21726 | 81 | 23828 | 84 | 25571 | 250 | 25927 | 63 | 27420 | 59 | 28103 | 380 | 28531 | 377 | 33405 | 226 |
| 14212 | 53 | 15562 | 113 | 20041 | 30 | 20570A | 32 | 21728 | 81 | 23830 | 85 | 25772 | 250 | 25928 | 63 | 27424 | 59 | 28131 | 382 | 28532 | 377 | 33406 | 226 |
| 14214 | 53 | 15563 | 113 | 20045 | 30 | 20570A | 114 | 21732 | 81 | 23832 | 84 | 25773 | 250 | 25929 | 63 | 27428 | 59 | 28132 | 382 | 28540 | 379 | 33407 | 226 |
| 14216 | 53 | 15565 | 395 | 20046 | 30 | 20570F | 32 | 21736 | 81 | 23836 | 84 | 25774 | 250 | 25931 | 63 | 27432 | 59 | 28133 | 382 | 28550 | 381 | 33408 | 226 |
| 14218 | 53 | 15566 | 113 | 20050 | 30 | 20570F | 114 | 22718 | 81 | 23840 | 84 | 25775 | 251 | 25932 | 63 | 27436 | 59 | 28141 | 378 | 28560 | 380 | 33409 | 226 |
| 14220 | 53 | 15567 | 113 | 20051 | 30 | 20628 | 31 | 22720 | 81 | 23900 | 89 | 25776 | 251 | 25932 | 108 | 27516 | 59 | 28151 | 376 | 31212 | 53 | 33410 | 226 |
| 14318 | 53 | 15720 | 115 | 20060 | 30 | 20628 | 109 | 22722 | 81 | 23900 | 120 | 25777 | 251 | 25933 | 63 | 27520 | 59 | 28161 | 378 | 31214 | 53 | 33411 | 226 |
| 14320 | 53 | 15725 | 115 | 20061 | 30 | 20630 | 31 | 22724 | 81 | 24114 | 92 | 25781 | 250 | 25935 | 63 | 27524 | 59 | 28172 | 376 | 31216 | 53 | 33412 | 226 |
| 14322 | 53 | 15730 | 115 | 20120 | 31 | 20630 | 109 | 22726 | 81 | 24118 | 92 | 25782 | 250 | 25936 | 63 | 27528 | 59 | 28175 | 373 | 31218 | 53 | 33413 | 226 |
| 14324 | 53 | 15735 | 115 | 20124 | 31 | 20632 | 31 | 22728 | 81 | 24120 | 92 | 25783 | 250 | 25936 | 108 | 27620 | 91 | 28176 | 373 | 31220 | 53 | 33414 | 226 |
| 14420 | 53 | 16020 | 29 | 20128 | 31 | 20632 | 109 | 22732 | 81 | 24122 | 92 | 25816 | 56 | 25940 | 63 | 27620 | 57 | 28177 | 373 | 31312 | 53 | 33415 | 226 |
| 14422 | 53 | 16021 | 29 | 20130 | 31 | 20634 | 31 | 22736 | 81 | 24123 | 93 | 25820 | 56 | 25940 | 108 | 27624 | 91 | 28182 | 378 | 31314 | 53 | 33416 | 226 |
| 14424 | 53 | 16024 | 29 | 20132 | 31 | 20634 | 109 | 23322 | 85 | 24124 | 92 | 25823 | 56 | 25950 | 63 | 27624 | 57 | 28190 | 367 | 31316 | 53 | 38010 | 217 |
| 14518 | 82 | 16025 | 29 | 20134 | 31 | 20636 | 31 | 23323 | 89 | 24125 | 93 | 25824 | 56 | 25956 | 63 | 27625 | 91 | 28191 | 367 | 31318 | 53 | 38015 | 196 |
| 14520 | 82 | 16028 | 29 | 20136 | 31 | 20636 | 109 | 23326 | 85 | 24126 | 92 | 25827 | 56 | 25958 | 63 | 27625 | 57 | 28192 | 367 | 31320 | 53 | 38015 | 154 |
| 14522 | 82 | 16029 | 29 | 20138 | 31 | 20638 | 31 | 23327 | 89 | 24127 | 93 | 25828 | 56 | 26400 | 96 | 27626 | 91 | 28193 | 367 | 32003 | 55 | 38220 | 211 |
| 14524 | 82 | 16032 | 29 | 20140 | 31 | 20638 | 109 | 23330 | 85 | 24128 | 92 | 25829 | 56 | 26520 | 90 | 27626 | 57 | 28194 | 367 | 32016 | 54 | 38221 | 210 |
| 14526 | 82 | 16033 | 29 | 20145 | 31 | 20640 | 31 | 23416 | 81 | 24129 | 93 | 25831 | 56 | 26522 | 90 | 27628 | 91 | 28195 | 367 | 32020 | 54 | 38222 | 210 |
| 14528 | 82 | 16036 | 29 | 20150 | 31 | 20640 | 109 | 23418 | 81 | 24130 | 92 | 25832 | 56 | 26524 | 90 | 27628 | 57 | 28196 | 367 | 32024 | 54 | 38223 | 210 |
| 14532 | 82 | 16037 | 29 | 20160 | 31 | 20645 | 31 | 23420 | 81 | 24134 | 93 | 25835 | 56 | 26526 | 90 | 27629 | 91 | 28197 | 367 | 32028 | 54</ | | |

| Ref. | Pag. | Ref. | Pag. | Ref. | Pag. | Ref. | Pag. | Ref. | Pag. | Ref. | Pag. |
|-------|------|-------|------|-------|------|-------|------|-------|------|-------|------|
| 38234 | 211 | 39041 | 273 | 39218 | 215 | 40136 | 44 | 45118 | 38 | 47318 | 104 |
| 38235 | 211 | 39042 | 273 | 39220 | 207 | 40140 | 44 | 45120 | 38 | 47320 | 37 |
| 38240 | 216 | 39043 | 136 | 39221 | 207 | 40212 | 45 | 45122 | 38 | 47320 | 104 |
| 38241 | 216 | 39044 | 136 | 39223 | 207 | 40214 | 45 | 45124 | 38 | 47322 | 37 |
| 38242 | 216 | 39047 | 136 | 39224 | 207 | 40216 | 45 | 45126 | 38 | 47322 | 104 |
| 38300 | 209 | 39048 | 136 | 39226 | 207 | 40218 | 45 | 45128 | 38 | 47324 | 37 |
| 38301 | 208 | 39049 | 226 | 39227 | 207 | 40220 | 45 | 45214 | 38 | 47324 | 104 |
| 38302 | 209 | 39050 | 226 | 39230 | 207 | 40318 | 45 | 45216 | 38 | 47328 | 37 |
| 38303 | 208 | 39060 | 216 | 39231 | 207 | 40324 | 45 | 45218 | 38 | 47328 | 104 |
| 38304 | 209 | 39061 | 216 | 39233 | 207 | 40420 | 44 | 45220 | 38 | 47330 | 37 |
| 38305 | 209 | 39064 | 213 | 39234 | 207 | 40424 | 44 | 45320 | 39 | 47330 | 104 |
| 38310 | 209 | 39075 | 215 | 39236 | 207 | 40426 | 44 | 45320 | 103 | 47418 | 37 |
| 38311 | 208 | 39088 | 207 | 39237 | 207 | 40428 | 44 | 45322 | 39 | 47418 | 104 |
| 38312 | 209 | 39089 | 207 | 39262 | 207 | 40619 | 45 | 45322 | 103 | 47420 | 37 |
| 38313 | 208 | 39090 | 207 | 39262 | 220 | 40619 | 101 | 45324 | 39 | 47420 | 104 |
| 38314 | 209 | 39091 | 207 | 39263 | 220 | 40620 | 45 | 45324 | 103 | 47422 | 37 |
| 38315 | 209 | 39092 | 207 | 39264 | 220 | 40621 | 45 | 45326 | 39 | 47422 | 104 |
| 38316 | 209 | 39093 | 207 | 39266 | 220 | 40621 | 101 | 45326 | 103 | 47424 | 37 |
| 38321 | 209 | 39100 | 216 | 39402 | 363 | 40622 | 45 | 45328 | 39 | 47424 | 104 |
| 38322 | 208 | 39101 | 216 | 39402 | 363 | 40623 | 45 | 45328 | 103 | 47428 | 37 |
| 38330 | 208 | 39108 | 219 | 39403 | 363 | 40623 | 101 | 45330 | 39 | 47428 | 104 |
| 38331 | 209 | 39109 | 219 | 39404 | 363 | 40624 | 45 | 45330 | 103 | 47430 | 37 |
| 38332 | 209 | 39110 | 212 | 39405 | 364 | 40625 | 45 | 45420 | 39 | 47430 | 104 |
| 38340 | 208 | 39112 | 212 | 39406 | 364 | 40625 | 101 | 45420 | 103 | 47620 | 37 |
| 38341 | 209 | 39114 | 212 | 39407 | 364 | 40626 | 45 | 45422 | 39 | 47624 | 37 |
| 38342 | 208 | 39115 | 212 | 39410 | 364 | 40627 | 45 | 45422 | 103 | 47628 | 37 |
| 38350 | 209 | 39116 | 212 | 39411 | 364 | 40627 | 101 | 45424 | 39 | 48016 | 61 |
| 38360 | 209 | 39118 | 212 | 39413 | 363 | 40628 | 45 | 45424 | 103 | 48020 | 61 |
| 38361 | 208 | 39121 | 212 | 39414 | 363 | 40629 | 45 | 45426 | 39 | 48024 | 61 |
| 38362 | 209 | 39124 | 560 | 39415 | 364 | 40629 | 101 | 45426 | 103 | 48028 | 61 |
| 38363 | 209 | 39125 | 212 | 39420 | 364 | 40632 | 45 | 45428 | 39 | 48116 | 61 |
| 38370 | 209 | 39126 | 563 | 39423 | 363 | 40636 | 45 | 45428 | 103 | 48120 | 61 |
| 38371 | 208 | 39127 | 563 | 39424 | 363 | 40640 | 45 | 45430 | 39 | 48124 | 61 |
| 38380 | 209 | 39129 | 561 | 39430 | 364 | 40712 | 45 | 45430 | 103 | 48128 | 61 |
| 38381 | 209 | 39132 | 562 | 39433 | 363 | 40714 | 45 | 45624 | 38 | 48214 | 61 |
| 38390 | 209 | 39134 | 563 | 39434 | 363 | 40716 | 45 | 45626 | 38 | 48216 | 61 |
| 38391 | 209 | 39135 | 561 | 39441 | 312 | 40718 | 45 | 45628 | 38 | 48218 | 61 |
| 39000 | 213 | 39136 | 563 | 39445 | 312 | 40916 | 45 | 45728 | 39 | 48220 | 61 |
| 39001 | 213 | 39138 | 562 | 39450 | 312 | 40918 | 45 | 45728 | 103 | 48624 | 61 |
| 39004 | 213 | 39139 | 562 | 40016 | 44 | 40920 | 45 | 45729 | 39 | 48628 | 61 |
| 39008 | 219 | 39140 | 558 | 40018 | 44 | 40922 | 45 | 45729 | 103 | 48720 | 98 |
| 39009 | 219 | 39140 | 362 | 40020 | 44 | 40924 | 45 | 45828 | 39 | 48720 | 61 |
| 39010 | 213 | 39160 | 558 | 40022 | 44 | 40926 | 45 | 45828 | 103 | 48724 | 98 |
| 39012 | 560 | 39160 | 362 | 40024 | 44 | 40928 | 45 | 45829 | 39 | 48724 | 61 |
| 39014 | 212 | 39161 | 558 | 40026 | 44 | 40932 | 45 | 45829 | 103 | 48728 | 98 |
| 39015 | 213 | 39161 | 362 | 40028 | 44 | 40936 | 45 | 45916 | 39 | 48728 | 61 |
| 39016 | 212 | 39162 | 362 | 40032 | 44 | 40940 | 45 | 45918 | 39 | 48916 | 61 |
| 39017 | 212 | 39163 | 362 | 40036 | 44 | 44320 | 104 | 45920 | 39 | 48920 | 61 |
| 39018 | 213 | 39164 | 362 | 40040 | 44 | 44324 | 104 | 45922 | 39 | 48924 | 61 |
| 39020 | 212 | 39165 | 206 | 40116 | 44 | 44328 | 104 | 45924 | 39 | 48928 | 61 |
| 39021 | 212 | 39166 | 362 | 40118 | 44 | 44420 | 104 | 45926 | 39 | 49014 | 214 |
| 39024 | 212 | 39169 | 206 | 40120 | 44 | 44424 | 104 | 45928 | 39 | 49016 | 214 |
| 39025 | 212 | 39170 | 206 | 40121 | 45 | 44428 | 104 | 47020 | 37 | 49017 | 214 |
| 39027 | 212 | 39171 | 206 | 40122 | 44 | 45016 | 38 | 47024 | 37 | 49021 | 214 |
| 39028 | 212 | 39172 | 206 | 40124 | 44 | 45018 | 38 | 47028 | 37 | 49024 | 214 |
| 39029 | 213 | 39185 | 212 | 40125 | 45 | 45020 | 38 | 47128 | 37 | 49025 | 214 |
| 39030 | 212 | 39208 | 215 | 40126 | 44 | 45022 | 38 | 47214 | 37 | 49027 | 214 |
| 39037 | 218 | 39210 | 215 | 40128 | 44 | 45024 | 38 | 47216 | 37 | 49030 | 214 |
| 39038 | 218 | 39212 | 215 | 40129 | 45 | 45026 | 38 | 47218 | 37 | 49110 | 214 |
| 39039 | 219 | 39213 | 215 | 40132 | 44 | 45028 | 38 | 47220 | 37 | 49112 | 214 |
| 39040 | 273 | 39215 | 215 | 40133 | 45 | 45116 | 38 | 47318 | 37 | 49116 | 214 |

| Ref. | Pag. | Ref. | Pag. | Ref. | Pag. | Ref. | Pag. | Ref. | Pag. | Ref. | Pag. |
|--------|------|--------|------|--------|------|-------|------|--------|------|--------|------|
| 49121 | 214 | 50132 | 24 | 50541 | 149 | 50837 | 149 | 54025 | 21 | 54221 | 22 |
| 49185 | 214 | 50132S | 24 | 50550 | 26 | 50840 | 322 | 54025S | 21 | 54224 | 22 |
| 49210 | 214 | 50135 | 24 | 50550 | 112 | 50840 | 178 | 54028 | 20 | 54225 | 22 |
| 49212 | 214 | 50135S | 24 | 50551 | 149 | 50841 | 149 | 54028S | 20 | 54225N | 22 |
| 49216 | 214 | 50136 | 24 | 50560 | 26 | 50845 | 322 | 54029 | 21 | 54228 | 22 |
| 50016 | 23 | 50136S | 24 | 50560 | 112 | 50845 | 178 | 54029S | 21 | 54229 | 22 |
| 50016S | 23 | 50139 | 24 | 50561 | 149 | 50846 | 149 | 54032 | 20 | 54229N | 22 |
| 50017 | 24 | 50139S | 24 | 50570 | 26 | 50850 | 322 | 54032S | 20 | 54621 | 22 |
| 50017S | 24 | 50140 | 24 | 50570 | 112 | 50850 | 178 | 54033 | 21 | 54625 | 22 |
| 50020 | 23 | 50140S | 24 | 50624 | 25 | 50851 | 149 | 54033S | 21 | 54629 | 22 |
| 50020S | 23 | 50145 | 24 | 50624 | 106 | 50916 | 26 | 54036 | 20 | 54633 | 22 |
| 50021 | 24 | 50145S | 24 | 50624S | 25 | 50918 | 26 | 54036S | 20 | 54636 | 22 |
| 50021S | 24 | 50150 | 24 | 50624S | 106 | 50920 | 26 | 54037 | 21 | 54636 | 106 |
| 50024 | 23 | 50150S | 24 | 50625 | 25 | 50924 | 26 | 54037S | 21 | 54636S | 22 |
| 50024S | 23 | 50160 | 24 | 50628 | 25 | 50928 | 26 | 54040 | 20 | 54636S | 106 |
| 50025 | 24 | 50160S | 24 | 50628 | 106 | 50932 | 26 | 54040S | 20 | 54637 | 22 |
| 50025S | 24 | 50212 | 25 | 50628S | 25 | 50934 | 71 | 54041 | 21 | 54640 | 22 |
| 50028 | 23 | 50214 | 25 | 50628S | 106 | 50936 | 26 | 54041S | 21 | 54640 | 106 |
| 50028S | 23 | 50216 | 25 | 50629 | 25 | 50940 | 26 | 54045 | 20 | 54640S | 22 |
| 50029 | 24 | 50217 | 25 | 50632 | 25 | 50945 | 26 | 54045S | 20 | 54640S | 106 |
| 50029S | 24 | 50218 | 25 | 50632 | 106 | 50950 | 26 | 54046 | 21 | 54645 | 22 |
| 50032 | 23 | 50219 | 25 | 50632S | 25 | 50960 | 26 | 54046S | 21 | 54645 | 106 |
| 50032S | 23 | 50220 | 25 | 50632S | 106 | 51216 | 26 | 54050 | 20 | 54645S | 22 |
| 50033 | 24 | 50221 | 25 | 50633 | 25 | 51218 | 26 | 54050S | 20 | 54645S | 106 |
| 50033S | 24 | 50224 | 25 | 50636 | 25 | 51220 | 26 | 54051 | 21 | 54650 | 22 |
| 50036 | 23 | 50225 | 25 | 50636 | 106 | 51222 | 26 | 54051S | 21 | 54650 | 106 |
| 50036S | 23 | 50225N | 26 | 50636S | 25 | 51224 | 26 | 54119 | 21 | 54650S | 22 |
| 50037 | 24 | 50228 | 25 | 50636S | 106 | 51620 | 80 | 54119S | 21 | 54650S | 106 |
| 50037S | 24 | 50229 | 25 | 50637 | 25 | 51621 | 80 | 54120 | 21 | 54916 | 71 |
| 50040 | 23 | 50229N | 26 | 50640 | 25 | 51624 | 80 | 54120S | 21 | 54916 | 22 |
| 50040S | 23 | 50300 | 322 | 50640 | 106 | 51625 | 80 | 54123 | 21 | 54920 | 71 |
| 50041 | 24 | 50301 | 451 | 50640S | 25 | 51628 | 80 | 54123S | 21 | 54920 | 22 |
| 50041S | 24 | 50320 | 146 | 50640S | 106 | 51629 | 80 | 54124 | 21 | 54924 | 71 |
| 50045 | 23 | 50323 | 322 | 50645 | 25 | 51632 | 80 | 54124S | 21 | 54924 | 22 |
| 50045S | 23 | 50323S | 322 | 50645 | 106 | 51633 | 80 | 54127 | 21 | 54928 | 71 |
| 50046 | 24 | 50324 | 146 | 50645S | 25 | 51636 | 80 | 54127S | 21 | 54928 | 22 |
| 50046S | 24 | 50327 | 322 | 50645S | 106 | 51637 | 80 | 54128 | 21 | 54932 | 71 |
| 50050 | 23 | 50327S | 322 | 50650 | 25 | 51640 | 80 | 54128S | 21 | 54932 | 22 |
| 50050S | 23 | 50328 | 146 | 50650 | 106 | 51641 | 80 | 54131 | 21 | 54936 | 71 |
| 50051 | 24 | 50332 | 149 | 50650S | 25 | 51720 | 80 | 54131S | 21 | 54936 | 22 |
| 50051S | 24 | 50333 | 322 | 50650S | 106 | 51724 | 80 | 54132 | 21 | 54940 | 71 |
| 50060 | 23 | 50333S | 322 | 50660 | 25 | 51728 | 80 | 54132S | 21 | 54940 | 22 |
| 50060S | 23 | 50334 | 146 | 50660 | 106 | 51732 | 80 | 54135 | 21 | 54945 | 71 |
| 50061 | 24 | 50336 | 149 | 50660S | 25 | 51736 | 80 | 54135S | 21 | 54945 | 22 |
| 50061S | 24 | 50337 | 322 | 50660S | 106 | 51740 | 80 | 54136 | 21 | 54950 | 71 |
| 50116 | 24 | 50337S | 322 | 50717 | 26 | 53720 | 100 | 54136S | 21 | 54950 | 22 |
| 50116S | 24 | 50338 | 146 | 50721 | 26 | 53721 | 100 | 54139 | 21 | 55216 | 22 |
| 50119 | 24 | 50340 | 149 | 50815 | 71 | 53724 | 100 | 54139S | 21 | 55220 | 22 |
| 50119S | 24 | 50341 | 322 | 50816 | 71 | 53725 | 100 | 54140 | 21 | 55224 | |

| Ref. | Pag. | Ref. | Pag. | Ref. | Pag. | Ref. | Pag. | Ref. | Pag. | Ref. | Pag. | Ref. | Pag. | Ref. | Pag. | Ref. | Pag. | Ref. | Pag. | Ref. | Pag. | Ref. | Pag. |
|-------|------|-------|------|-------|------|-------|------|-------|------|-------|------|-------|------|-------|------|-------|------|-------|------|-------|------|-------|------|
| 55412 | 439 | 55473 | 439 | 55534 | 440 | 55595 | 440 | 55656 | 443 | 55732 | 441 | 55793 | 441 | 55854 | 442 | 55915 | 442 | 55976 | 444 | 56620 | 35 | 57220 | 28 |
| 55413 | 439 | 55474 | 439 | 55535 | 440 | 55596 | 440 | 55657 | 443 | 55733 | 441 | 55794 | 441 | 55855 | 442 | 55916 | 442 | 55977 | 444 | 56624 | 35 | 57221 | 28 |
| 55414 | 439 | 55475 | 439 | 55536 | 440 | 55597 | 440 | 55658 | 443 | 55734 | 441 | 55795 | 441 | 55856 | 442 | 55917 | 442 | 55978 | 444 | 56720 | 35 | 57224 | 28 |
| 55415 | 439 | 55476 | 439 | 55537 | 440 | 55598 | 440 | 55659 | 443 | 55735 | 441 | 55796 | 441 | 55857 | 442 | 55918 | 442 | 55979 | 444 | 56720 | 102 | 57225 | 28 |
| 55416 | 439 | 55477 | 439 | 55538 | 440 | 55599 | 440 | 55660 | 443 | 55736 | 441 | 55797 | 441 | 55858 | 442 | 55919 | 442 | 55980 | 444 | 56724 | 35 | 57302 | 436 |
| 55417 | 439 | 55478 | 439 | 55539 | 440 | 55600 | 440 | 55661 | 443 | 55737 | 441 | 55798 | 441 | 55859 | 442 | 55920 | 442 | 55981 | 444 | 56724 | 102 | 57317 | 436 |
| 55418 | 439 | 55479 | 439 | 55540 | 440 | 55601 | 440 | 55662 | 443 | 55738 | 441 | 55799 | 441 | 55860 | 442 | 55921 | 442 | 55982 | 444 | 56728 | 35 | 57320 | 436 |
| 55419 | 439 | 55480 | 439 | 55541 | 440 | 55602 | 440 | 55663 | 443 | 55739 | 441 | 55800 | 441 | 55861 | 442 | 55922 | 442 | 55983 | 444 | 56728 | 102 | 57321 | 437 |
| 55420 | 439 | 55481 | 439 | 55542 | 440 | 55603 | 440 | 55664 | 443 | 55740 | 441 | 55801 | 441 | 55862 | 442 | 55923 | 442 | 55984 | 444 | 56732 | 35 | 57322 | 437 |
| 55421 | 439 | 55482 | 439 | 55543 | 440 | 55604 | 440 | 55665 | 443 | 55741 | 441 | 55802 | 441 | 55863 | 442 | 55924 | 442 | 56007 | 436 | 56732 | 102 | 57325 | 437 |
| 55422 | 439 | 55483 | 439 | 55544 | 440 | 55605 | 440 | 55666 | 443 | 55742 | 441 | 55803 | 441 | 55864 | 442 | 55925 | 442 | 56008 | 436 | 56820 | 35 | 57330 | 436 |
| 55423 | 439 | 55484 | 439 | 55545 | 440 | 55606 | 440 | 55667 | 443 | 55743 | 441 | 55804 | 441 | 55865 | 442 | 55926 | 442 | 56009 | 436 | 56820 | 102 | 57435 | 437 |
| 55424 | 439 | 55485 | 439 | 55546 | 440 | 55607 | 440 | 55668 | 443 | 55744 | 441 | 55805 | 441 | 55866 | 442 | 55927 | 442 | 56010 | 436 | 56824 | 35 | 57624 | 28 |
| 55425 | 439 | 55486 | 439 | 55547 | 440 | 55608 | 440 | 55669 | 443 | 55745 | 441 | 55806 | 441 | 55867 | 442 | 55928 | 442 | 56011 | 436 | 56824 | 102 | 57624 | 106 |
| 55426 | 439 | 55487 | 439 | 55548 | 440 | 55609 | 440 | 55670 | 443 | 55746 | 441 | 55807 | 441 | 55868 | 442 | 55929 | 442 | 56012 | 436 | 56828 | 35 | 57625 | 28 |
| 55427 | 439 | 55488 | 439 | 55549 | 440 | 55610 | 440 | 55671 | 443 | 55747 | 441 | 55808 | 441 | 55869 | 442 | 55930 | 442 | 56013 | 436 | 56828 | 102 | 57628 | 28 |
| 55428 | 439 | 55489 | 439 | 55550 | 440 | 55611 | 440 | 55672 | 443 | 55748 | 441 | 55809 | 441 | 55870 | 442 | 55931 | 444 | 56014 | 436 | 56832 | 35 | 57628 | 106 |
| 55429 | 439 | 55490 | 439 | 55551 | 440 | 55612 | 440 | 55673 | 443 | 55749 | 441 | 55810 | 441 | 55871 | 442 | 55932 | 444 | 56015 | 436 | 56832 | 102 | 57629 | 28 |
| 55430 | 439 | 55491 | 439 | 55552 | 440 | 55613 | 440 | 55674 | 443 | 55750 | 441 | 55811 | 441 | 55872 | 442 | 55933 | 444 | 56212 | 428 | 56914 | 35 | 57632 | 28 |
| 55431 | 439 | 55492 | 439 | 55553 | 440 | 55614 | 440 | 55675 | 443 | 55751 | 441 | 55812 | 441 | 55873 | 442 | 55934 | 444 | 56216 | 428 | 56916 | 35 | 57632 | 106 |
| 55432 | 439 | 55493 | 439 | 55554 | 440 | 55615 | 440 | 55676 | 443 | 55752 | 441 | 55813 | 441 | 55874 | 442 | 55935 | 444 | 56302 | 436 | 56918 | 35 | 57636 | 28 |
| 55433 | 439 | 55494 | 439 | 55555 | 440 | 55616 | 440 | 55677 | 443 | 55753 | 441 | 55814 | 441 | 55875 | 442 | 55936 | 444 | 56317 | 436 | 56920 | 35 | 57636 | 106 |
| 55434 | 439 | 55495 | 439 | 55556 | 440 | 55617 | 440 | 55678 | 443 | 55754 | 441 | 55815 | 441 | 55876 | 442 | 55937 | 444 | 56320 | 436 | 56924 | 35 | 57640 | 28 |
| 55435 | 439 | 55496 | 439 | 55557 | 440 | 55618 | 440 | 55679 | 443 | 55755 | 441 | 55816 | 441 | 55877 | 442 | 55938 | 444 | 56321 | 437 | 56928 | 35 | 57640 | 106 |
| 55436 | 439 | 55497 | 439 | 55558 | 440 | 55619 | 440 | 55680 | 443 | 55756 | 441 | 55817 | 441 | 55878 | 442 | 55939 | 444 | 56322 | 437 | 56932 | 35 | 57717 | 28 |
| 55437 | 439 | 55498 | 439 | 55559 | 440 | 55620 | 440 | 55681 | 443 | 55757 | 441 | 55818 | 441 | 55879 | 442 | 55940 | 444 | 56325 | 437 | 57007 | 436 | 57721 | 28 |
| 55438 | 439 | 55499 | 439 | 55560 | 440 | 55621 | 440 | 55682 | 443 | 55758 | 441 | 55819 | 441 | 55880 | 442 | 55941 | 444 | 56330 | 436 | 57008 | 436 | 57916 | 28 |
| 55439 | 439 | 55500 | 439 | 55561 | 440 | 55622 | 440 | 55683 | 443 | 55759 | 441 | 55820 | 442 | 55881 | 442 | 55942 | 444 | 56412 | 428 | 57009 | 436 | 57920 | 28 |
| 55440 | 439 | 55501 | 439 | 55562 | 440 | 55623 | 440 | 55684 | 443 | 55760 | 441 | 55821 | 442 | 55882 | 442 | 55943 | 444 | 56416 | 428 | 57010 | 436 | 57924 | 28 |
| 55441 | 439 | 55502 | 439 | 55563 | 440 | 55624 | 440 | 55700 | 438 | 55761 | 441 | 55822 | 442 | 55883 | 442 | 55944 | 444 | 56435 | 437 | 57011 | 436 | 57928 | 28 |
| 55442 | 439 | 55503 | 439 | 55564 | 440 | 55625 | 440 | 55701 | 438 | 55762 | 441 | 55823 | 442 | 55884 | 442 | 55945 | 444 | 56502 | 437 | 57012 | 436 | 57932 | 28 |
| 55443 | 439 | 55504 | 439 | 55565 | 440 | 55626 | 440 | 55702 | 438 | 55763 | 441 | 55824 | 442 | 55885 | 442 | 55946 | 444 | 56507 | 437 | 57013 | 436 | 57936 | 28 |
| 55444 | 439 | 55505 | 439 | 55566 | 440 | 55627 | 440 | 55703 | 438 | 55764 | 441 | 55825 | 442 | 55886 | 442 | 55947 | 444 | 56508 | 437 | 57014 | 436 | 57940 | 28 |
| 55445 | 439 | 55506 | 439 | 55567 | 440 | 55628 | 440 | 55704 | 438 | 55765 | 441 | 55826 | 442 | 55887 | 442 | 55948 | 444 | 56509 | 437 | 57015 | 436 | 58050 | 292 |
| 55446 | 439 | 55507 | 439 | 55568 | 440 | 55629 | 440 | 55705 | 438 | 55766 | 441 | 55827 | 442 | 55888 | 442 | 55949 | 444 | 56510 | 437 | 57016 | 27 | 58150 | 292 |
| 55447 | 439 | 55508 | 439 | 55569 | 440 | 55630 | 440 | 55706 | 438 | 55767 | 441 | 55828 | 442 | 55889 | 442 | 55950 | 444 | 56511 | 437 | 57017 | 27 | 58151 | 292 |
| 55448 | 439 | 55509 | 439 | 55570 | 440 | 55631 | 443 | 55707 | 438 | 55768 | 441 | 55829 | 442 | 55890 | 442 | 55951 | 444 | 56512 | 437 | 57020 | 27 | 58152 | 292 |
| 55449 | 439 | 55510 | 439 | 55571 | 440 | 55632 | 443 | 55708 | 438 | 55769 | 441 | 55830 | 442 | 55891 | 442 | 55952 | 444 | 56513 | 437 | 57021 | 27 | 58153 | 292 |
| 55450 | 439 | 55511 | 439 | 55572 | 440 | 55633 | 443 | 55709 | 441 | 55770 | 441 | 55831 | 442 | 55892 | 442 | 55953 | 444 | 56514 | 437 | 57024 | 27 | 58250 | 292 |
| 55451 | 439 | 55512 | 439 | 55573 | 440 | 55634 | 443 | 55710 | 441 | 55771 | 441 | 55832 | 442 | 55893 | 442 | 55954 | 444 | 56515 | 437 | 57025 | 27 | 58251 | 292 |
| 55452 | 439 | 55513 | 439 | 55574 | 440 | 55635 | 443 | 55711 | 441 | 55772 | 441 | 55833 | 442 | 55894 | 442 | 55955 | 444 | 56517 | 437 | 57028 | 27 | 58252 | 292 |
| 55453 | 439 | 55514 | 439 | 55575 | 440 | 55636 | 443 | 55712 | 441 | 55773 | 441 | 55834 | 442 | 55895 | 442 | 55956 | 444 | 56520 | 437 | 57029 | 27 | 58253 | 292 |
| 55454 | 439 | 55515 | 439 | 55576 | 440 | 55637 | 443 | 55713 | 441 | 55774 | 441 | 55835 | 442 | 55896 | 442 | 55957 | 444 | 56522 | 436 | 57032 | 27 | 58450 | 292 |
| 55455 | 439 | 55516 | 439 | 55577 | 440 | 55638 | 443 | 55714 | 441 | 55775 | 441 | 55836 | 442 | 55897 | 442 | 55958 | 444 | 56523 | 436 | 57033 | 27 | 60000 | 199 |
| 55456 | 439 | 55517 | 439 | 55578 | 440 | 55639 | 443 | 55715 | 441 | 55776 | 441 | 55837 | 442 | 55898 | 442 | 55959 | 444 | 56524 | 437 | 57036 | 27 | 60001 | 217 |
| 55457 | 439 | 55518 | 439 | 55579 | 440 | 55640 | 443 | 55716 | 441 | 55777 | 441 | 55838 | 442 | 55899 | 442 | 55960 | 444 | 56525 | 437 | 57037 | 27 | 60002 | 126 |
| 55458 | 439 | 55519 | 439 | 55580 | 440 | 55641 | 443 | 55717 | 441 | 55778 | 441 | 55839 | 442 | 55900 | 442 | 55961 | 444 | 56526 | 437 | 57040 | 27 | 60003 | 126 |
| 55459 | 439 | 55520 | 440 | 55581 | 440 | 55642 | 443 | 55718 | 441 | 55779 | 441 | 55840 | 442 | 55901 | 442 | 55962 | 444 | 56527 | 437 | 57041 | 27 | 60004 | 199 |
| 55460 | 439 | 55521 | 440 | 55582 | 440 | 55643 | 443 | 55719 | 441 | 55780 | 441 | 55841 | 442 | 55902 | 442 | 55963 | 444 | 56600 | 35 | 57116 | 28 | 60005 | 199 |
| 55461 | 439 | 55522 | 440 | 55583 | 440 | 55644 | 443 | 55720 | 441 | 55781 | 441 | 55842 | 442 | 55903 | 442 | 55964 | 444 | 56601 | 35 | 57120 | 28 | 60007 | 352 |
| 55462 | 439 | 55523 | 440 | 55584 | 440 | 55645 | 443 | 55721 | 441 | 55782 | 441 | 55843 | 442 | 55904 | 442 | 55965 | 444 | 56601 | 102 | 57124 | 28 | 60008 | 352 |
| 55463 | 439 | 55524 | 440 | 55585 | 440 | 55646 | 443 | 55722 | 441 | 55783 | 441 | 55844 | 442 | 55905 | 442 | 55966 | 444 | 56602 | 35 | 57128 | 28 | 60009 | 199 |
| 55464 | 439 | 55525 | 440 | 55586 | 440 | 55647 | 443 | 55723 | 441 | 55784 | 441 | 55845 | 442 | 55906 | 442 | 55967 | 444 | 56603 | 35 | 57132 | 28 | 60010 | 119 |
| 55465 | 439 | 55526 | 440 | 55587 | 440 | 55648 | 443 | 55724 | 441 | 55785 | 441 | 55846 | 442 | 55907 | 442 | 55968 | 444 | 56603 | 102 | 57136 | 28 | 60011 | 119 |
| 55466 | 439 | 55527 | 440 | 55588 | 440 | 55649 | 443 | 55725 | 441 | 55786 | 441 | 55847 | 442 | 55908 | 442 | 55969 | 444 | 56604 | 35 | 57140 | 28 | 60013 | 322 |
| 55467 | 439 | 55528 | 440 | 55589 | 440 | 55650 | 443 | 55726 | 441 | | | | | | | | | | | | | | |

| Ref. | Pag. | Ref. | Pag. | Ref. | Pag. | Ref. | Pag. | Ref. | Pag. | Ref. | Pag. |
|--------|------|-------|------|-------|------|-------|------|-------|------|-------|------|
| 67828 | 353 | 68054 | 323 | 68240 | 358 | 68460 | 358 | 68591 | 359 | 68740 | 351 |
| 67832 | 353 | 68057 | 323 | 68246 | 331 | 68461 | 355 | 68597 | 359 | 68741 | 351 |
| 67836 | 353 | 68058 | 323 | 68247 | 331 | 68462 | 355 | 68598 | 359 | 68760 | 349 |
| 67901 | 421 | 68060 | 352 | 68248 | 352 | 68463 | 355 | 68601 | 308 | 68770 | 349 |
| 67901Z | 421 | 68061 | 352 | 68250 | 323 | 68464 | 355 | 68602 | 308 | 68780 | 355 |
| 67902 | 421 | 68069 | 332 | 68252 | 323 | 68465 | 230 | 68604 | 337 | 68781 | 355 |
| 67902Z | 421 | 68070 | 332 | 68253 | 323 | 68465 | 115 | 68605 | 337 | 68782 | 355 |
| 67903 | 421 | 68078 | 269 | 68254 | 323 | 68466 | 230 | 68607 | 358 | 68783 | 355 |
| 67903Z | 421 | 68079 | 269 | 68270 | 129 | 68466 | 115 | 68608 | 358 | 68784 | 355 |
| 67904 | 421 | 68080 | 153 | 68271 | 129 | 68470 | 355 | 68609 | 358 | 68785 | 355 |
| 67904Z | 421 | 68082 | 153 | 68272 | 129 | 68471 | 355 | 68610 | 358 | 68786 | 355 |
| 67905 | 421 | 68085 | 150 | 68273 | 129 | 68472 | 355 | 68612 | 358 | 68787 | 355 |
| 67905Z | 421 | 68085 | 150 | 68274 | 129 | 68473 | 355 | 68614 | 358 | 68788 | 355 |
| 67906 | 421 | 68090 | 324 | 68275 | 129 | 68480 | 358 | 68616 | 358 | 68789 | 355 |
| 67906Z | 421 | 68091 | 332 | 68276 | 129 | 68482 | 359 | 68618 | 358 | 68790 | 355 |
| 67909 | 421 | 68092 | 332 | 68280 | 133 | 68488 | 359 | 68619 | 292 | 68791 | 355 |
| 67909Z | 421 | 68099 | 332 | 68281 | 133 | 68492 | 359 | 68620 | 358 | 68792 | 355 |
| 67910 | 401 | 68101 | 157 | 68282 | 133 | 68498 | 359 | 68622 | 358 | 68793 | 355 |
| 67911 | 401 | 68102 | 157 | 68283 | 133 | 68500 | 337 | 68624 | 358 | 68794 | 355 |
| 67914 | 400 | 68107 | 359 | 68284 | 133 | 68501 | 337 | 68626 | 358 | 68795 | 355 |
| 67916 | 400 | 68120 | 359 | 68285 | 153 | 68502 | 337 | 68627 | 292 | 68796 | 355 |
| 67918 | 400 | 68121 | 359 | 68300 | 337 | 68506 | 358 | 68628 | 358 | 68797 | 355 |
| 67920 | 401 | 68132 | 324 | 68301 | 337 | 68508 | 358 | 68629 | 292 | 68798 | 355 |
| 67921 | 401 | 68136 | 324 | 68305 | 198 | 68509 | 358 | 68639 | 292 | 68799 | 355 |
| 67924 | 400 | 68137 | 324 | 68306 | 198 | 68510 | 358 | 68640 | 351 | 68801 | 331 |
| 67926 | 400 | 68141 | 330 | 68307 | 198 | 68511 | 342 | 68641 | 351 | 68802 | 331 |
| 67928 | 400 | 68142 | 330 | 68308 | 358 | 68512 | 358 | 68642 | 351 | 68803 | 331 |
| 67934 | 400 | 68150 | 330 | 68310 | 358 | 68513 | 342 | 68643 | 292 | 68804 | 331 |
| 67938 | 400 | 68151 | 330 | 68340 | 323 | 68514 | 358 | 68644 | 292 | 68805 | 342 |
| 67944 | 400 | 68153 | 330 | 68341 | 323 | 68516 | 358 | 68651 | 509 | 68806 | 194 |
| 67948 | 400 | 68154 | 330 | 68342 | 323 | 68518 | 358 | 68651 | 335 | 68808 | 353 |
| 67951 | 401 | 68161 | 330 | 68350 | 323 | 68520 | 358 | 68652 | 509 | 68810 | 353 |
| 67952 | 401 | 68173 | 132 | 68351 | 323 | 68522 | 358 | 68652 | 335 | 68814 | 353 |
| 68000 | 356 | 68174 | 132 | 68354 | 323 | 68524 | 358 | 68659 | 351 | 68818 | 353 |
| 68001 | 352 | 68175 | 132 | 68357 | 323 | 68526 | 358 | 68660 | 351 | 68821 | 353 |
| 68002 | 352 | 68176 | 132 | 68402 | 337 | 68527 | 332 | 68661 | 291 | 68822 | 353 |
| 68003 | 352 | 68177 | 132 | 68402 | 170 | 68532 | 359 | 68662 | 291 | 68823 | 353 |
| 68004 | 352 | 68178 | 132 | 68403 | 337 | 68536 | 359 | 68663 | 291 | 68824 | 353 |
| 68005 | 153 | 68179 | 132 | 68403 | 170 | 68537 | 359 | 68664 | 291 | 68825 | 353 |
| 68006 | 153 | 68180 | 198 | 68404 | 337 | 68538 | 359 | 68666 | 291 | 68827 | 353 |
| 68007 | 261 | 68181 | 161 | 68405 | 337 | 68540 | 359 | 68667 | 291 | 68828 | 353 |
| 68007 | 231 | 68182 | 161 | 68406 | 358 | 68544 | 359 | 68668 | 291 | 68829 | 353 |
| 68008 | 342 | 68185 | 133 | 68407 | 358 | 68546 | 359 | 68676 | 354 | 68831 | 353 |
| 68008 | 269 | 68186 | 133 | 68408 | 358 | 68547 | 359 | 68680 | 354 | 68832 | 353 |
| 68009 | 268 | 68187 | 133 | 68410 | 358 | 68548 | 359 | 68684 | 354 | 68833 | 353 |
| 68010 | 356 | 68188 | 133 | 68411 | 358 | 68550 | 359 | 68686 | 354 | 68835 | 353 |
| 68017 | 261 | 68189 | 133 | 68412 | 358 | 68552 | 359 | 68688 | 354 | 68836 | 353 |
| 68017 | 231 | 68195 | 133 | 68414 | 358 | 68554 | 359 | 68696 | 354 | 68842 | 353 |
| 68021 | 268 | 68196 | 133 | 68416 | 358 | 68556 | 359 | 68714 | 356 | 68862 | 353 |
| 68023 | 323 | 68197 | 193 | 68418 | 358 | 68557 | 359 | 68716 | 356 | 68863 | 353 |
| 68024 | 323 | 68197 | 133 | 68420 | 358 | 68558 | 359 | 68718 | 356 | 68882 | 353 |
| 68026 | 323 | 68198 | 193 | 68422 | 358 | 68560 | 359 | 68720 | 261 | 68892 | 339 |
| 68030 | 352 | 68198 | 133 | 68424 | 358 | 68566 | 359 | 68720 | 231 | 68893 | 339 |
| 68031 | 352 | 68199 | 133 | 68441 | 358 | 68567 | 359 | 68723 | 353 | 68898 | 334 |
| 68040 | 352 | 68200 | 359 | 68450 | 354 | 68568 | 359 | 68724 | 353 | 68899 | 334 |
| 68041 | 352 | 68203 | 359 | 68451 | 355 | 68570 | 359 | 68725 | 356 | 68900 | 339 |
| 68043 | 352 | 68205 | 287 | 68452 | 355 | 68580 | 359 | 68729 | 353 | 68908 | 339 |
| 68048 | 352 | 68213 | 330 | 68453 | 355 | 68581 | 359 | 68730 | 356 | 68910 | 339 |
| 68049 | 352 | 68215 | 287 | 68454 | 355 | 68587 | 359 | 68732 | 353 | 68912 | 339 |
| 68050 | 323 | 68225 | 287 | 68455 | 355 | 68588 | 359 | 68735 | 356 | 68915 | 339 |
| 68053 | 323 | 68235 | 287 | 68456 | 355 | 68590 | 359 | 68739 | 351 | 68928 | 339 |

| Ref. | Pag. | Ref. | Pag. | Ref. | Pag. | Ref. | Pag. | Ref. | Pag. | Ref. | Pag. |
|-------|------|-------|------|-------|------|-------|------|-------|------|-------|------|
| 68930 | 338 | 69028 | 392 | 69110 | 389 | 69223 | 487 | 69296 | 406 | 69371 | 498 |
| 68932 | 339 | 69029 | 260 | 69111 | 466 | 69225 | 447 | 69297 | 524 | 69373 | 535 |
| 68934 | 339 | 69030 | 393 | 69115 | 486 | 69226 | 447 | 69297 | 293 | 69374 | 467 |
| 68935 | 338 | 69032 | 399 | 69115 | 462 | 69227 | 504 | 69298 | 523 | 69379 | 503 |
| 68936 | 356 | 69033 | 399 | 69116 | 540 | 69230 | 483 | 69298 | 292 | 69380 | 535 |
| 68937 | 338 | 69034 | 389 | 69118 | 483 | 69231 | 533 | 69299 | 463 | 69382 | 536 |
| 68939 | 338 | 69036 | 516 | 69120 | 533 | 69232 | 500 | 69300 | 556 | 69384 | 467 |
| 68940 | 338 | 69037 | 315 | 69121 | 486 | 69232 | 500 | 69302 | 547 | 69385 | 526 |
| 68941 | 335 | 69038 | 513 | 69122 | 510 | 69233 | 456 | 69303 | 547 | 69386 | 537 |
| 68942 | 339 | 69039 | 513 | 69123 | 487 | 69234 | 448 | 69304 | 547 | 69387 | 537 |
| 68945 | 338 | 69041 | 291 | 69125 | 483 | 69235 | 447 | 69306 | 462 | 69388 | 464 |
| 68947 | 335 | 69042 | 544 | 69130 | 483 | 69236 | 447 | 69310 | 555 | 69389 | 536 |
| 68948 | 339 | 69045 | 542 | 69131 | 388 | 69237 | 447 | 69312 | 497 | 69396 | 530 |
| 68950 | 338 | 69046 | 544 | 69132 | 408 | 69238 | 551 | 69313 | 555 | 69396 | 284 |
| 68954 | 338 | 69047 | 544 | 69134 | 490 | 69239 | 551 | 69314 | 554 | 69397 | 523 |
| 68955 | 338 | 69048 | 544 | 69135 | 490 | 69240 | 447 | 69317 | 511 | 69397 | 293 |
| 68959 | 262 | 69050 | 542 | 69136 | 232 | 69241 | 448 | 69317 | 341 | 69398 | 530 |
| 68960 | 338 | 69051 | 544 | 69138 | 410 | 69242 | 516 | 69318 | 511 | 69398 | 284 |
| 68964 | 338 | 69052 | 544 | 69139 | 386 | 69243 | 461 | 69319 | 511 | 69399 | 512 |
| 68965 | 338 | 69053 | 544 | 69140 | 232 | 69244 | 460 | 69320 | 554 | 69399 | 263 |
| 68966 | 262 | 69054 | 544 | 69141 | 559 | 69245 | 460 | 69321 | 171 | 69400 | 568 |
| 68967 | 262 | 69055 | 544 | 69141 | 221 | 69246 | 461 | 69322 | 499 | 69401 | 568 |
| 68968 | 335 | 69056 | 544 | 69145 | 410 | 69247 | 508 | 69323 | 499 | 69410 | 565 |
| 68969 | 334 | 69057 | 544 | 69146 | 232 | 69248 | 448 | 69324 | 499 | 69411 | 565 |
| 68970 | 338 | 69058 | 544 | 69147 | 508 | 69249 | 448 | 69325 | 499 | 69414 | 565 |
| 68971 | 338 | 69059 | 544 | 69148 | 508 | 69250 | 447 | 69327 | 497 | 69420 | 566 |
| 68972 | 338 | 69061 | 412 | 69149 | 509 | 69251 | 447 | 69329 | 499 | 69421 | 566 |
| 68973 | 338 | 69062 | 531 | 69151 | 542 | 69256 | 529 | 69330 | 499 | 69422 | 566 |
| 68974 | 335 | 69064 | 531 | 69152 | 232 | 69256 | 285 | 69332 | 399 | 69423 | 566 |
| 68976 | 262 | 69065 | 530 | 69156 | 232 | 69259 | 544 | 69333 | 399 | 69424 | 567 |
| 68977 | 262 | 69065 | 406 | 69163 | 531 | 69260 | 531 | 69334 | 459 | 69425 | 567 |
| 68978 | 262 | 69066 | 530 | 69165 | 232 | 69261 | 559 | 69336 | 514 | 69426 | 567 |
| 68979 | 262 | 69066 | 406 | 69166 | 507 | 69261 | 221 | 69336 | 391 | 69427 | 567 |
| 68980 | 339 | 69068 | 482 | 69167 | 507 | 69263 | 516 | 69337 | 498 | 69428 | 529 |
| 68981 | 334 | 69070 | 553 | 69168 | 232 | 69264 | 516 | 69338 | 537 | 69428 | 286 |
| 68982 | 334 | 69073 | 481 | 69169 | 489 | 69266 | 517 | 69340 | 554 | 69429 | 528 |
| 68983 | 334 | 69075 | 553 | 69170 | 490 | 69267 | 517 | 69341 | 559 | 69429 | 285 |
| 68984 | 335 | 69077 | 481 | 69172 | 530 | 69272 | 527 | 69341 | 221 | 69431 | 555 |
| 68985 | 339 | 69079 | 485 | 69172 | 406 | 69273 | 527 | 69343 | 457 | 69432 | 557 |
| 68987 | 262 | 69081 | 539 | 69173 | 530 | 69274 | 527 | 69344 | 457 | 69433 | 510 |
| 68988 | 334 | 69084 | 464 | 69173 | 406 | 69275 | 527 | 69345 | 461 | 69435 | 528 |
| 68989 | 340 | 69087 | 385 | 69179 | 503 | 69276 | 523 | 69346 | 456 | 69435 | 286 |
| 68991 | 339 | 69088 | 386 | 69192 | 547 | 69276 | 293 | 69347 | 497 | 69438 | 460 |
| 68992 | 339 | 69089 | 384 | 69193 | 548 | 69277 | 524 | 69348 | 505 | 69439 | 460 |
| 68993 | 339 | 69091 | 384 | 69195 | 538 | 69277 | 293 | 69349 | 509 | 69440 | 531 |
| 68994 | 339 | 69092 | 385 | 69196 | 510 | 69278 | 527 | 69352 | 540 | 69441 | 456 |
| 68996 | 339 | 69093 | | | | | | | | | |

Índice alfabético

Sommaire alphabétique

Alphabetisch Index

Alphabetical Index

Indice alfabético

ES Índice alfabético

A

| | |
|-------------------------|---------------|
| ABLANDACARNE | 160 |
| ABRE OSTRAS | 192, 272 |
| ACEITERA | 264 |
| AERÓGRAFO | 333, 511 |
| AFILADOR CUCHILLOS | 220, 221, 557 |
| AGUJA DE MECHAR | 167 |
| AHUMADOR | 171 |
| AIREADOR DE VINO | 309 |
| AIRPOT | 392, 523 |
| ANILLA ANTI-GOTEO | 309 |
| ARMARIO ESTERILIZADOR | 548, 558 |
| ARMARIO REFRIGERADOR | 549, 551 |
| ARO | 352, 358, 359 |
| ARO PERFORADO | 359 |
| ASA / MANGO DESMONTABLE | 35, 102 |
| ASA DE SILICONA | 59, 120 |
| ASADOR | 88 |
| ASADOR DE SALCHICHAS | 456 |
| ATRILPORTA MENÚ | 363 |
| AZUCARERO | 260, 290 |

B

| | |
|---------------------------|---|
| BANDEJA | 113, 242, 253, 430, 431 |
| BANDEJA / FUENTE | 230, 231, 232, 234, 235, 236, 237, 239, 240, 243, 253, 261 |
| BANDEJA CAMARERO | 231, 232 |
| BANDEJA HORNO | 32, 355 |
| BANDEJA ISOTÉRMICA | 426, 432 |
| BAÑO MARIA | 26, 28, 341, 509, 514 |
| BARRA SUJECCIÓN NOTAS | 136 |
| BÁSCULA | 182, 183, 184, 185, 186, 187, 319, 555 |
| BATIDOR | 291, 465, 471, 472, 473, 475 |
| BATIDORA | 462, 463, 464, 465, 467, 468, 469, 470, 474, 476, 477, 478, 533, 534, 535, 536, 537 |
| BIBERÓN DECORACIÓN | 340 |
| BOBINA FILM | 452 |
| BOBINA VACÍO | 542 |
| BOL | 176, 177, 235, 237, 239, 240, 253, 259, 320, 321 |
| BOLAS AISLANTES SOUS VIDE | 547 |
| BOLSAS VACÍO | 542 |
| BOMBA VACÍO | 312 |
| BOQUILLA SERVIDORA | 309 |
| BOQUILLAS | 339 |
| BOTELLA BIBERÓN | 340 |
| BOTELLA DOSIFICADORA | 64, 249 |
| BOTELLA PERSONAL | 282 |
| BOTES ORGANIZADORES | 163 |
| BOTES VACÍO | 542 |

C

| | |
|----------------|---|
| CACEROLA | 20, 23, 27, 29, 30, 35, 37, 38, 41, 43, 44, 46, 48, 50, 52, 53, 54, 56, 57, 59, 61, 65, 395 |
| CACEROLA ALTA | 21, 24, 27, 29, 30 |
| CACEROLA BAJA | 37, 56, 57 |
| CACEROLA OVAL | 62, 63, 66, 69 |
| CACEROLA VAPOR | 25, 43, 44, 47, 49, 51, 55, 152 |
| CACILLO | 135 |
| CACILLO SALSA | 142 |
| CADENA | 352 |
| CAFETERA | 285, 286, 287, 288, 289, 290, 526, 527 |
| CAFETERA GOTEO | 524, 525 |

| | |
|----------------------|--|
| CAFETERA PERCOLADORA | 393, 523 |
| CALDERO | 178, 322 |
| CALENTADOR | 514, 563, 564, 565, 566 |
| CALENTADOR CHAFING | 389, 512 |
| CAMPANA | 260, 399 |
| CAMPANA AHUMADOR | 172 |
| CAMPANILLA | 261 |
| CARRO SERVICIO | 427, 428, 433 |
| CASCANUECES | 272 |
| CATERING | 397 |
| CAZO BOMBADO | 31 |
| CAZO CÓNICO | 22, 26 |
| CAZO FRANCÉS | 22, 26 |
| CAZO RECTO | 22, 25, 28, 29, 31, 35, 37, 38, 41, 43, 45, 47, 49, 51, 52, 53, 54, 55, 57, 59, 61, 63, 64, 88, 178, 249 |

| | |
|--------------------------|--|
| CAZO RECTO ALTO | 22, 25, 28, 31 |
| CEDAZO | 323 |
| CENTRIFUGADORA | 166 |
| CEPILLO PARA TABLA CORTE | 225 |
| CEPILLO RECOGEDOR | 261, 451 |
| CESTA | 447, 448 |
| CESTILLO | 152, 255 |
| CHAFING DISH | 385, 386, 387, 388, 389, 390, 391, 512 |
| CHAIRA | 213, 215 |
| CHOCOLATERA | 510 |
| COCEDOR AL VAPOR | 484 |
| COCEDOR DE HUEVOS | 455 |
| COCEDOR DE SALCHICHAS | 456 |
| COCTELERA | 307 |
| COLADOR | 45, 47, 51, 55, 146, 147, 308 |
| CONTENEDOR ALIMENTOS | 163 |
| CONTENEDOR CUBIERTOS | 136 |
| COPA | 343 |
| CORDEL COCINA | 117 |
| CORDÓN DE CUERO | 367 |
| CORTA VEGETALES | 460, 482, 484 |
| CORTADOR | 191, 192, 194, 197, 198, 199, 481 |
| CORTADOR PATATAS | 198 |
| CORTADORA FIAMBRE | 481 |
| CORTAPASTAS | 331 |
| CORTAPIZZA | 143 |
| CORTATARTAS | 332 |
| CREPERA | 39, 85, 89, 93, 95, 97, 103, 508 |
| CUBERTERO | 226, 227 |
| CUBETA | 395, 418, 419, 420, 422, 423, 425 |

| | |
|--------------------------|--|
| CUBETA PERFORADA | 419, 420 |
| CUBIERTOS | 226 |
| CUBITERA | 296, 307 |
| CUBO | 178 |
| CUBO ENFRIABOTELLAS | 299, 300 |
| CUBRE QUESO/TARTA | 260 |
| CUBREPLATOS | 260, 399, 433 |
| CUCHARA APOYA UTENSILIOS | 136 |
| CUCHARA LISA | 240 |
| CUCHARA MIEL | 272 |
| CUCHILLO | 134, 191, 192, 193, 208, 209, 210, 211, 212, 214, 215, 216 |
| CUECE ESPECIAS | 152 |
| CUECEPASTAS | 44 |
| CUSCUSERA | 55 |

D

| | |
|---------------|----------|
| DELANTAL | 121, 122 |
| DESCÁPSULADOR | 309 |

ES Índice alfabético

| | |
|-------------------------|---------------|
| DESCORAZONADOR | 192, 193, 198 |
| DESESCAMADOR DE PESCADO | 273 |
| DESHIDRATADOR | 485 |
| DESHOJADOR DE HIERVAS | 198 |
| DISPENSADOR | 265, 393, 394 |
| DISPENSADOR JABÓN | 449 |
| DOBLE FONDO | 421, 422, 423 |
| DOSIFICADOR | 150 |
| DOSIFICADOR LICOR | 308 |

E

| | |
|--------------------|---|
| EMBUDO | 150 |
| EMBUTIDORA MANUAL | 165 |
| ENCENDEDOR | 262 |
| ENSALADERA | 259 |
| ESCURREFRITOS | 149 |
| ESCURREPLATOS | 452 |
| ESCURRIDERA | 45, 47, 51, 55, 148, 149 |
| ESPÁTULA | 134, 135, 138, 139, 326, 342 |
| ESPÁTULA LISA | 138, 139, 192 |
| ESPÁTULA PIZZA | 142 |
| ESPECIERO | 265 |
| ESPUMADERA | 126 |
| ESPUMADOR DE LECHE | 284, 528 |
| ESTANTE TUBULAR | 428 |
| ESTANTERIA | 436, 437, 438, 439, 440, 441, 442, 443, 444 |
| ESTECAS | 324 |
| EXPOSITOR | 396 |
| EXPRIMIDOR | 161, 530, 531, 533 |

F

| | |
|-------------------------|--|
| FLANERO | 350, 352, 353 |
| FONDUE | 263, 510 |
| FREIDORA | 487, 488, 489, 490, 491, 492, 493, 494 |
| FRUTEROS | 256 |
| FUENTE CHOCOLATE | 511 |
| FUENTE HONDA | 178, 322 |
| FUENTE PARA MANTEQUILLA | 259 |
| FUNDA CARRO | 428 |
| FUNDA ENFRIABOTELLAS | 295 |

G

| | |
|-----------------|--------------------|
| GARRAS DE OSO | 154, 196 |
| GEL COMBUSTIBLE | 263, 389 |
| GOFRERA | 507 |
| GRILL | 57, 59, 91, 95, 97 |
| GUANTE | 118, 119 |
| GUIA DIVIDORA | 420 |

H

| | |
|------------------|--------------------|
| HARINERO | 149 |
| HERVIDOR | 152 |
| HERVIDOR AGUA | 292, 293, 521, 522 |
| HERVIDOR PESCADO | 32 |
| HORNO | 495, 496, 497 |

I

| | |
|---------------------|-----|
| INDICADOR RESERVADO | 260 |
|---------------------|-----|

J

| | |
|-----------------------------------|----------|
| JAMONERO | 205 |
| JARRA DE AGUA | 302, 433 |
| JARRA SEPARADOR GRASA | 264 |
| JARRA TERMO | 279, 280 |
| JUEGO DE UTENSILIOS DE COCTELERÍA | 305 |
| JUEGO SALERO-PIMENTERO | 264 |
| JUEGO VINAGRERAS | 264 |

L

| | |
|-----------------------|---------------|
| LÁMINA | 485 |
| LAMINADOR | 164, 194, 199 |
| LÁMPARA CALENTAMIENTO | 516, 517 |
| LECHERA | 290, 292 |
| LEGUNBRERA | 259 |
| LIBRADOR | 307, 319 |
| LICUADORA | 532 |
| LLAUNAS ARROZ | 113 |

M

| | |
|-----------------------|---|
| MACHETE | 213 |
| MALETA CUCHILLOS | 213 |
| MALETÍN BBQ | 134 |
| MANDOLINA | 202, 203 |
| MANGA REPOSTERÍA | 338 |
| MANO CHINO | 147 |
| MANO MORTERO | 155 |
| MANOPLA | 63, 120 |
| MANTEL INDIVIDUAL | 275, 276 |
| MÁQUINA CUBITOS HIELO | 552 |
| MÁQUINA DE HELADO | 460, 552 |
| MÁQUINA ENFRIACOPAS | 554 |
| MÁQUINA VACÍO | 162, 538, 539, 540, 541 |
| MARCADOR TARTA | 342 |
| MARTILLO | 160 |
| MATAMOSQUITOS | 559, 560, 561 |
| MAZA | 160, 308 |
| MEDIDOR | 175, 176, 318, 321 |
| MEDIDOR PASTA | 164 |
| MELAMINA | 241, 242, 244, 246, 254, 399 |
| MICROONDAS | 497 |
| MINI GRILL | 504 |
| MINI-CUBO | 255 |
| MOLDE BAGUETTE | 354 |
| MOLDE EMPANADILLAS | 157 |
| MOLDE HUEVO | 153 |
| MOLDE PIZZA | 142, 353 |
| MOLDE REPOSTERÍA | 345, 346, 347, 348, 349, 350, 352, 353, 355, 356, 358 |
| MOLINILLO | 266, 267, 284, 524 |
| MORTERO | 155 |

N

| | |
|---------------|----------|
| NIDOS ALAMBRE | 147 |
| NÚMEROS MESA | 260, 303 |

O

| | |
|------|--|
| OLLA | 21, 24, 28, 29, 31, 38, 41, 43, 44, 46, 48, 50, 52, 53, 54, 61, 452, 501 |
|------|--|

ES Índice alfabético

| | |
|-------------------------------|--------------------------------|
| OLLA A PRESIÓN | 71, 72, 73, 74, 75, 76, 77, 78 |
| OLLA BAJA | 21, 24 |
| OLLA SUPER ALTA | 41, 45, 47, 49, 51, 54 |
| ORGANIZADOR ACCESORIOS CÓCTEL | 306 |
| ORGANIZADOR DE CAFÉ | 393 |
| ORGANIZADOR DE CUBIERTOS | 226 |
| ORGANIZADOR DE CUCHILLOS | 226 |

P

| | |
|--------------------------|---|
| PAELLERA | 22, 25, 28, 29, 31, 63, 65, 85, 88, 93, 106, 107, 108, 109, 110, 249 |
| PAJITAS | 353 |
| PALA | 139 |
| PALA PARA PATATAS FRITAS | 140 |
| PALA PASTEL | 192 |
| PALA PIZZA | 142, 143 |
| PANERA | 256 |
| PAPELERA | 261, 450 |
| PARRILLA | 421 |
| PASAPURÉS | 157 |
| PEINE CARNE | 199 |
| PEINE DECORACIÓN | 324 |
| PELADOR | 191, 192, 193, 194, 207 |
| PICADORA | 195, 479 |
| PICADORA CARNE | 480 |
| PICADORA HIELO | 307, 553 |
| PIE PORTACUBOS | 298 |
| PINCEL | 134 |
| PINCHO MARISCO | 273 |
| PINCHO MARUNO | 136 |
| PINZA | 134, 268, 269, 270, 271, 308, 342, 421 |
| PINZAS | 269 |
| PIPETA PARA SALSA | 167 |
| PISTOLA GAS | 334, 335 |
| PISTOLA REPOSTERÍA | 340 |
| PIZARRA | 232, 362, 364, 396, 556 |
| PLACA CALENTAMIENTO | 525 |
| PLACA HORNO | 116 |
| PLACA INDUCCIÓN | 498, 499 |
| PLACA VITROCERÁMICA | 500 |
| PLANCHA GRILL | 89, 93, 94, 501, 502 |
| PLANCHA-GRILL | 502, 505 |
| PLATO | 235, 237, 243, 432, 433 |
| PLATO DE HUEVOS | 231 |
| PORTA COMANDAS | 373, 374 |
| PORTA FACTURAS | 371, 373, 374 |
| PORTA MENÚ | 364, 367, 370, 371, 372, 373, 374, 375, 376, 377, 378, 379, 380, 381, 382 |

| | |
|---------------------|------------------------------------|
| PORTAPLATOS | 429 |
| PORTARROLLOS | 451, 452 |
| PORTATARTA | 342 |
| POSABOTELLAS | 231 |
| POSAVASOS | 231 |
| POSTE SEPARADOR | 453 |
| POTE CILINDRICO | 31, 41, 43, 45, 47, 49, 51, 52, 55 |
| PRENSA AJOS | 156, 192, 201 |
| PRENSA HAMBURGUESAS | 159 |
| PRENSA PATATAS | 156 |
| PULVERIZADOR | 264 |

Q

| | |
|----------|----------|
| QUEMADOR | 335, 507 |
| QUESERA | 224, 260 |

R

| | |
|-----------------------------|-----------------------|
| RACIONADOR HELADO | 343 |
| RALLADOR | 200, 201 |
| RASERA | 126, 200 |
| RASQUETA | 324 |
| RECIPIENTES INOX | 179, 180, 181 |
| RECLETTE | 503 |
| REFRIGERADOR | 551 |
| REJILLA PARA SOUS VIDE | 547 |
| REJILLA REPOSTERÍA | 342 |
| RELOJ COCINA | 123 |
| RIBETEADOR DE COPAS Y VASOS | 306 |
| ROBOT MULTIFUNCIÓN | 225, 483 |
| RODILLO | 330 |
| ROTULADORES PIZARRA | 362, 556 |
| RUSTIDERA | 26, 32, 112, 114, 115 |

S

| | |
|-----------------------------|--|
| SACACORCHOS | 310, 311, 550 |
| SALAMANDRA | 501 |
| SALSERA | 259 |
| SALVAMANTELES | 277 |
| SARTÉN | 35, 37, 39, 45, 49, 57, 59, 61, 65, 80, 81, 82, 83, 84, 85, 87, 88, 90, 91, 92, 94, 95, 96, 97, 98, 99, 100, 101, 102, 103, 104, 249 |
| SAUTEX | 22, 25, 28, 49 |
| SELLOS PARA GALLETAS | 332 |
| SEPARADOR CLARAS | 153 |
| SERVILLETERO | 261, 452 |
| SET UTENSILIOS | 131 |
| SIFÓN | 170, 337 |
| SIFÓN AGUA | 308 |
| SOPERA | 259 |
| SOPORTE BATIDORA BRISK | 467, 470 |
| SOPORTE COPAS | 304 |
| SOPORTE CUBIERTOS | 227 |
| SOPORTE MAGNÉTICO | 219 |
| SOPORTE MENU | 260 |
| SOPORTE MESA ENFRIABOTELLAS | 298 |
| SOPORTE PAELLERA | 110 |
| SOPORTE PAELLERA GAS BUTANO | 110 |
| SOPORTE PARA BANDEJAS | 231 |
| SOPORTE PARA HUEVO | 153 |
| SOPORTE PARA ROLLO | 539 |
| SOUS VIDE | 544, 545, 546 |
| SUJETA MANTELES | 260 |

T

| | |
|------------------|--|
| TABLA DE CORTE | 205, 222, 223, 224, 225 |
| TABLA SERVIR | 247, 253 |
| TABLA SERVIR | |
| TABLA SERVIR | |
| TABLA SERVIR | 254 |
| TACO CUCHILLO | 213, 218 |
| TAPA | 22, 26, 28, 29, 32, 35, 37, 39, 41, 43, 45, 47, 49, 51, 52, 55, 57, 59, 61, 90, 115, 395 |
| TAPA PARA CUBETA | 421, 422, 423 |
| TAPETE | 117, 350 |

ES Índice alfabético

| | |
|-----------------------------|------------------------------------|
| TAPETE COCTELERÍA | 305 |
| TAPÓN | 309 |
| TARTERA | 38, 43, 45, 47, 51, 52, 55, 59, 61 |
| TAZA | 433 |
| TAZAS COCTELERÍA | 306 |
| TENAZA MARISCO | 272 |
| TENEDOR | 134, 212, 214 |
| TERMO | 280, 281, 282 |
| TERMÓMETRO | 188, 189 |
| TERMOTRANS | 426 |
| TETERA | 290, 291 |
| TIJERAS | 217 |
| TOSTADORA | 406, 528, 529 |
| TRIANGULO | 147 |
| TRITURADOR MANUAL DE TOMATE | 199 |

V

| | |
|--------------------|--------------------|
| VASO | 282, 306, 433 |
| VITRINA EXPOSITORA | 312, 313, 314, 315 |

W

| | |
|-----|--|
| WOK | 39, 43, 85, 86, 89, 93, 95, 97, 100, 103 |
|-----|--|

Y

| | |
|-----------|----------|
| YOGURTERA | 458, 459 |
|-----------|----------|

FR Index alphabétique

A

| | |
|----------------------------|-------------------------|
| AÉRATEUR DE VIN | 309 |
| AÉROGRAPHE | 333, 511 |
| AFÛTEUSE DE COUTEAUX | 220, 221, 557 |
| AIGUILLE À LARDER | 167 |
| AIRPOT | 392, 523 |
| ALLUME-GAZ | 262 |
| AMOVIBLE POIGNÉE / ANSE | 35, 102 |
| ANNEAU STOP GOUTTLES À VIN | 309 |
| APPAREIL ANTI-MOUSTIQUES | 559, 560, 561 |
| ARAIGNEE | 126, 200 |
| ARDOISE | 232, 362, 364, 396, 556 |
| ARMOIRE À STÉRILISER | 548, 558 |
| ASSIETTE | 235, 237, 243, 432, 433 |
| ATTENDRISEUR À VIANDE | 160 |

B

| | |
|----------------------------|---|
| BAC | 395, 418, 419, 420, 422, 423, 425 |
| BAC PERFORE | 419, 420 |
| BAHUT | 26, 28, 341, 509, 514 |
| BAIN MARIE | 385, 386, 387, 388, 389, 390, 391, 512 |
| BALANCE | 182, 183, 184, 185, 186, 187, 319, 555 |
| BARRE À NOTES | 136 |
| BASSINE | 178, 322 |
| BASSINE PÂTISIERE | 178, 322 |
| BATTEUR | 462, 463, 464, 465, 467, 468, 469, 470, 474, 476, 477, 478, 533, 534, 535, 536, 537 |
| BEC VERSEUR | 309 |
| BEURRIER AVEC COUVERCLE | 259 |
| BIBERON À DECORER | 340 |
| BILLES ISOLANTES SOUS VIDE | 547 |
| BLOC COUTEAU | 213, 218 |
| BOBINE DE CONSERVATION | 542 |
| BOÎTE À CONDIMENTS | 163 |
| BOITE À FROMAGE | 224, 260 |
| BOÎTES DE CONSERVATION | 542 |
| BOL | 176, 177, 235, 237, 239, 240, 253, 259, 320, 321 |
| BOUCHON | 312 |
| BOUILLORE | 292, 293, 521, 522 |
| BOUTEILLE BIBERON | 340 |
| BOUTEILLE DOSEUSE | 64, 249 |
| BRAISIERE | 21, 24, 27, 29, 30 |
| BROCHETTE | 136 |
| BROSSE POUR PLANCHE | 225 |
| BROYEUR À GLAÇONS | 307, 553 |

C

| | |
|---------------------|--|
| CAFETIÈRE | 285, 286, 287, 288, 289, 290, 526, 527 |
| CAFETIÈRE FILTRE | 524, 525 |
| CASIER | 447, 448 |
| CASSE NOIX | 272 |
| CASSEROLE | 22, 25, 28, 29, 31, 35, 37, 38, 41, 43, 45, 47, 49, 51, 52, 53, 54, 55, 57, 59, 61, 63, 64, 88, 178, 249 |
| CASSEROLE BOMBÉE | 31 |
| CASSEROLE FRANÇAISE | 22, 26 |
| CASSEROLE HAUTE | 22, 25, 28, 31 |
| CERCLE | 352, 358, 359 |
| CERCLE PERFOREE | 359 |
| CHAÎRE | 352 |
| CHARIOT DE SERVICE | 427, 428, 433 |
| CHAUFFE | 514, 563, 564, 565, 566 |
| CHAUFFE-CHAFING | 389, 512 |

| | |
|-----------------------|--|
| CHOCOLATIÈRE | 510 |
| CISEAUX | 217 |
| CLOCHE | 260, 399 |
| CLOCHE À FUMER | 172 |
| CLOCHES | 260, 399, 433 |
| COCOTTE À PRESSION | 71, 72, 73, 74, 75, 76, 77, 78 |
| CONTENEURS INOX | 179, 180, 181 |
| CORBILLE À FRUITS | 256 |
| CORDON EN CUIR | 367 |
| COUPE | 343 |
| COUPE CAPSULE | 309 |
| COUPE PATE | 324 |
| COUPE-POMMES DE TERRE | 198 |
| COUPELLE | 433 |
| COUPER | 191, 192, 194, 197, 198, 199, 481 |
| COUPERET | 213 |
| COUSCOUSSIER | 55 |
| COUTEAU | 134, 191, 192, 193, 208, 209, 210, 211, 212, 214, 215, 216 |
| COUTEAU À HUITRES | 192, 272 |
| COUTELLERIE | 226, 227 |
| COUVERCLE | 22, 26, 28, 29, 32, 35, 37, 39, 41, 43, 45, 47, 49, 51, 52, 55, 57, 59, 61, 90, 115, 395 |

| | |
|-----------------------------|----------------------------------|
| COUVERCLE POUR BAC | 421, 422, 423 |
| COUVERT | 226 |
| COUVRE FROMAGE/GÂTEAU | 260 |
| CREMIERE | 290, 292 |
| CREPIÈRE | 39, 85, 89, 93, 95, 97, 103, 508 |
| CUILLÈRE À GLACE | 343 |
| CUILLERE À MIEL | 272 |
| CUILLÈRE RAMASSE USTENSILES | 136 |
| CUILLÈREE LISSE | 240 |
| CUISEUR À OEUFS | 455 |
| CUISEUR VAPEUR | 484 |
| CUIT-PÂTE | 44 |
| CURETTES À HOMARD | 273 |

D

| | |
|----------------------------|---------------|
| DECOUPOIRS DIVERS | 331 |
| DEROULEUR | 451, 452 |
| DESHYDRATEUR | 485 |
| DESSOUS DE PLATS | 277 |
| DIFFUSEUR ÉPICES | 152 |
| DISTRIBUTEUR | 265, 393, 394 |
| DISTRIBUTEUR À SAVON | 449 |
| DISTRIBUTEUR DE SERVIETTES | 261, 452 |
| DOUBLE FOND | 421, 422, 423 |
| DOUILLES | 339 |

E

| | |
|--------------------------------------|-----|
| ECUMOIRE | 126 |
| EFFEUILLEUSE À HERBES | 198 |
| EMPORTE-PIÈCES À GÂTEAU | 332 |
| ENSEMBLE D'USTENSILES | 131 |
| ENSEMBLE D'USTENSILES POUR COCKTAILS | 305 |
| ENTONNOIR | 150 |
| ENTONNOIR À DECOR | 150 |
| ESSOREUSE | 166 |
| EXPOSANT | 396 |

F

| | |
|---------|---|
| FAITOUT | 20, 23, 27, 29, 30, 35, 37, 38, 41, 43, 44, 46, 48, 50, 52, |
|---------|---|

| | |
|---------------------|--|
| | 53, 54, 56, 57, 59, 61, 65, 395 |
| FAITOUT BASSE | 37, 56, 57 |
| FAITOUT OVALE | 62, 63, 66, 69 |
| FER À CARAMELISER | 335, 507 |
| FEUILLES | 485 |
| FIL DE CUISINE | 117 |
| FONDUE | 263, 510 |
| FONTAINE CHOCOLAT | 511 |
| FOUET | 291, 465, 471, 472, 473, 475 |
| FOUR | 495, 496, 497 |
| FOURCHETTE | 134, 212, 214 |
| FRITEUSE | 487, 488, 489, 490, 491, 492, 493, 494 |
| FRUIT CENTRIFUGEUSE | 532 |
| FUMOIR | 171 |
| FUSIL | 213, 215 |

G

| | |
|-------------------|--------------------|
| GANT | 118, 119 |
| GAUFRIER | 507 |
| GEL CHAUFFE | 263, 389 |
| GRATTOIR | 273 |
| GRIFFES À VIANDE | 154, 196 |
| GRILL | 57, 59, 91, 95, 97 |
| GRILL À SAUCISSES | 456 |
| GRILLE | 421 |
| GRILLE-PAIN | 406, 528, 529 |
| GUIDE DE DIVISION | 420 |
| GURIDON PÂTISIER | 342 |

H

| | |
|------------------------|---------------|
| HACHOIR | 200, 201 |
| HACHOIR LÉGUMES | 460, 482, 484 |
| HACHOIR POUR VIANDE | 480 |
| HOUSSE CHARIOT | 428 |
| HOUSSE REFROIDISSEMENT | 295 |
| HUILIER | 264 |

I

| | |
|--------------------|-----|
| INDICATEUR RÉSEVÉE | 260 |
|--------------------|-----|

L

| | |
|--------------------|----------|
| LAMPE DE CHAUFFAGE | 516, 517 |
| LEGUMIERE | 259 |
| LLAUNAS ARROZ | 113 |
| LOUCHE | 135 |
| LOUCHE SAUCE | 142 |

M

| | |
|-----------------------------|--|
| MACHINE À GIVRER LES VERRES | 554 |
| MACHINE À GLAÇONS | 552 |
| MACHINE À HOT-DOGS | 456 |
| MACHINE DE CRÈME GLACÉE | 460, 552 |
| MACHINE SOUS VIDE | 162, 538, 539, 540, 541 |
| MALLETTE BARBECUE | 134 |
| MANCHE EN SILICONE | 59, 120 |
| MANDOLINE | 202, 203 |
| MARMITE | 21, 24, 28, 29, 31, 38, 41, 43, 44, 46, 48, 50, 52, 53, 54, 61, 452, 501 |
| MARMITE BASSE | 21, 24 |

| | |
|---------------------|---|
| MARMITE S. HAUTE | 41, 45, 47, 49, 51, 54 |
| MARQUEUR À GATEAUX | 342 |
| MARQUEURS TABLEAU | 362, 556 |
| MARTEAU | 160 |
| MÉLAMINE | 241, 242, 244, 246, 254, 399 |
| MELLETE DE CHEF | 213 |
| MESURE À COCKTAIL | 308 |
| MESUREUE POUR PÂTES | 164 |
| MESUREUR | 175, 176, 318, 321 |
| MICRO-ONDES | 497 |
| MINI GRILL | 504 |
| MINI-CUBE | 255 |
| MORTIER | 155 |
| MOUFLETTE | 63, 120 |
| MOULE À BAGUETTE | 354 |
| MOULE À CHAUSSONS | 157 |
| MOULE À FLAN | 350, 352, 353 |
| MOULE À OEUF | 153 |
| MOULE À PÂTISSERIE | 345, 346, 347, 348, 349, 350, 352, 353, 355, 356, 358 |

| | |
|-----------------|--------------------|
| MOULE À PIZZA | 142, 353 |
| MOULIN | 266, 267, 284, 524 |
| MOUSSEUR À LAIT | 284, 528 |

N

| | |
|------------------|----------|
| NAPPE INDIVIDUEL | 275, 276 |
| NUMÉROS DE TABLE | 260, 303 |

O

| | |
|---|-----|
| ORGANISATEUR DE CAFÉ | 393 |
| ORGANISATEUR DE COUTEAUX | 226 |
| ORGANISATEUR DE COUVERTS | 226 |
| ORGANISATEUR POUR ACCESSOIRES DE COCKTAIL | 306 |
| ORGANISER LES BOUTEILLES | 163 |
| OUTILS | 324 |

P

| | |
|-----------------------|---------------------------------|
| PALETTE À GÂTEAU | 192 |
| PANIER | 152, 255 |
| PANIER À COUVERTS | 136 |
| PANIER À NID | 147 |
| PANIER MARGUERITE | 152 |
| PANIER POUR COUVERT | 226, 227 |
| PANIER VAPEUR | 25, 43, 44, 47, 49, 51, 55, 152 |
| PANIERE | 256 |
| PASSOIRE | 45, 47, 51, 55, 146, 147, 308 |
| PASSOIRE A FRITURE | 149 |
| PASSOIRE SUR PIED | 45, 47, 51, 55, 148, 149 |
| PAT À OEUFS | 231 |
| PEIGNE À PATE | 324 |
| PEIGNE POUR VIANDE | 199 |
| PELLE | 139 |
| PELLE À FARINE | 307, 319 |
| PELLE A FRITES | 140 |
| PELLE PIZZA | 142, 143 |
| PERCOLATEUR À CAFÉ | 393, 523 |
| PERSONNELLE BOUTEILLE | 282 |
| PICHET THERMO | 279, 280 |
| PIED POUR RECHAUD | 110 |
| PILON | 160, 308 |
| PINCE À CASSE-HOMARD | 272 |
| PINCE À NAPPE | 260 |

| | |
|--------------------------|--|
| PINCEAU | 134, 268, 269, 270, 271, 308, 342, 421 |
| PINCES | 269 |
| PISTOLET POUR PÂTISSERIE | 340 |
| PLANCHE À DÉCOUPER | 205, 222, 223, 224, 225 |
| PLAQUE À FOUR | 32, 355 |
| PLAQUE À GRILL | 89, 93, 94, 501, 502 |
| PLAQUE À INDUCTION | 498, 499 |
| PLAQUE POUR CHAUFFANTE | 525 |
| PLAQUE VITROCÉRAMIQUE | 500 |
| PLAT À ROTIR | 26, 32, 112, 114, 115 |
| PLAT ROND | 38, 43, 45, 47, 51, 52, 55, 59, 61 |
| PLATEAU | 113, 242, 253, 430, 431 |
| PLATEAU ISOTHERME | 426, 432 |
| PLATEAU LIMONADIER | 231, 232 |
| PO-CILINDRIQUE | 31, 41, 43, 45, 47, 49, 51, 52, 55 |
| POCHE À DECORER | 338 |
| POËLE | 35, 37, 39, 45, 49, 57, 59, 61, 65, 80, 81, 82, 83, 84, 85, 87, 88, 90, 91, 92, 94, 95, 96, 97, 98, 99, 100, 101, 102, 103, 104, 249 |
| POIRE À JUS | 167 |
| POISSONNIÈRE AVEC GRILLE | 32 |
| POMPE À VINE | 312 |
| PORTE-COMMANDES | 373, 374 |
| PORTE-FACTURES | 371, 373, 374 |
| PORTE-MENU | 364, 367, 370, 371, 372, 373, 374, 375, 376, 377, 378, 379, 380, 381, 382 |

| | |
|-----------------------|--------------------|
| PORTE-PLAQUE | 429 |
| PORTE-ROULEAU | 539 |
| PORTE-SEAU | 298 |
| POT À EAU | 302, 433 |
| POTEAU SÉPARATEUR | 453 |
| POUBELLE | 261, 450 |
| POUSSOIR À CHINOIS | 147 |
| POUSSOIR À MORTIER | 155 |
| POUSSOIR MANUEL | 165 |
| PRESSE À HAMBURGUERS | 159 |
| PRESSE-AGRUMES | 161, 530, 531, 533 |
| PRESSE-PAIL | 156, 192, 201 |
| PRESSE-PUREE | 157 |
| PRESSE-TOMATES MANUEL | 199 |
| PULVÉRISATEUR | 264 |
| PUPIPRE PORTE-MENU | 363 |

R

| | |
|----------------------|---|
| RACK POUR SOUS VIDE | 547 |
| RAMASSE-MIETTES | 261, 451 |
| RAYONNAGE | 436, 437, 438, 439, 440, 441, 442, 443, 444 |
| RECHAUD | 110 |
| RECLETTE | 503 |
| REFROIDISSEUR | 551 |
| REFROIDISSEUR À VIN | 549, 551 |
| RESTAURATION | 397 |
| ROBOT MULTIFONCTIONS | 225, 483 |
| RÔTISSOIRE | 88 |
| ROULEAU FILM | 452 |
| ROULEAU PÂTISIER | 330 |
| ROULETTE PIZZA | 143 |

S

| | |
|----------------------|-----|
| SACS DE CONSERVATION | 542 |
| SALADIER | 259 |
| SALAMANDRE | 501 |
| SAUCIERE | 259 |

| | |
|----------------------------------|------------------------------|
| SAUPOUDREUSE | 265 |
| SAUTASE CONIQUE | 22, 26 |
| SAUTEUSE | 22, 25, 28, 49 |
| SDESSOUS DE BOUTEILLE | 231 |
| SEAU | 178 |
| SEAU À GLACE | 296, 307 |
| SEAU À VIN | 299, 300 |
| SÉPARATEUR À OEUF | 153 |
| SEPARATEUR DE GRAISSE | 264 |
| SET CALIÈRE ET POIWIÈRE | 264 |
| SET VINAIGRIÈRE | 264 |
| SHAKER | 307 |
| SIPHON | 170, 337 |
| SIPHON À EAU | 308 |
| SONNETTE | 261 |
| SOUPIÈRE | 259 |
| SOUS VIDE | 544, 545, 546 |
| SOUS-VERRE | 231 |
| SPATULA | 134, 135, 138, 139, 326, 342 |
| SPATULE LISSE | 138, 139, 192 |
| SPATULE PIZZA | 142 |
| SUCREUR/SALEUR BORDEUR DE VERRES | 306 |
| SUCRIER | 260, 290 |
| SUPPORT À COUPES | 304 |
| SUPPORT D'OEUFS | 153 |
| SUPPORT MAGNETIQUE | 219 |
| SUPPORT MÉLANGEUR BRISK | 467, 470 |
| SUPPORT MENU | 260 |
| SUPPORT POUR JAMBON | 205 |
| SUPPORT POUR PLATEAUX | 231 |
| SUPPORT SEAU | 298 |

T

| | |
|---------------------------|---------------|
| TABLE DE SERVICE | 247, 253 |
| TAMIS | 323 |
| TAMIS À FARINE | 149 |
| TAMPONS POUR BISCUITS | 332 |
| TAPIS | 117, 350 |
| TAPIS ÉGOUTTOIR | 305 |
| TASSES À COCKTAIL | 306 |
| THÉIÈRE | 290, 291 |
| THERMO | 280, 281, 282 |
| THERMOMETRE | 188, 189 |
| THERMOTRANS | 426 |
| TIRE-BOUCHON | 310, 311, 550 |
| TORCHE À CARAMELISER | 334, 335 |
| TRANCHEUSE DE CHARCUTERIE | 481 |
| TRIANGLE | 147 |

V

| | |
|-------------------------|--------------------|
| VERRE | 282, 306, 433 |
| VIDE-POMMES | 192, 193, 198 |
| VITRINI DE PRÉSENTATION | 312, 313, 314, 315 |

W

| | |
|-----|--|
| WOK | 39, 43, 85, 86, 89, 93, 95, 97, 100, 103 |
|-----|--|

Y

| | |
|------------|----------|
| YAOURTIÈRE | 458, 459 |
|------------|----------|

DE Alphabetischer Index

A

| | |
|--------------------------------------|--------------------------|
| ABNEHMBAR STIELGRIFFE / SEITENGRIFFE | 35, 102 |
| ABTROPFMATTE | 452 |
| ABTROPFSCHÜSSEL | 45, 47, 51, 55, 148, 149 |
| ABTROPFSHÜSSEL FÜR FRITTIERTES | 149 |
| ADBECKUNG FÜR TELLERWAGEN | 428 |
| AIRBRUSH | 333, 511 |
| APFELENTKERNER | 192, 193, 198 |
| APPARAT ZUM RAUCHARN | 171 |
| AUSFSCHNITTMASCHINE | 481 |
| AUSGIESS-AUFSATZ | 309 |
| AUSSTELLER | 396 |
| AUSTERMESSER | 192, 272 |

B

| | |
|---------------------|-----------------------|
| BACKBLECH-AUFLAGE | 117, 350 |
| BACKSCHAUFEL | 138, 139, 192 |
| BAGUETTEFORM | 354 |
| BAIN MARIE | 26, 28, 341, 509, 514 |
| BESTECK | 226 |
| BESTECK-ORGANISATOR | 226 |
| BLACKBLECH | 32, 355 |
| BLÄTTER | 485 |
| BRATENTOPF | 37, 56, 57 |
| BRATPFANNE | 26, 32, 112, 114, 115 |
| BRENNER | 335, 507 |
| BRENNPASTE | 263, 389 |

| | |
|-------------------------|----------|
| BRULLIERBRENNEN | 334, 335 |
| BRUSH FÜR SCHNEIDEBRETT | 225 |
| BUTTERDOSE MIT DECKEL | 259 |

C

| | |
|---------------------|--|
| CHAFING DISH | 385, 386, 387, 388, 389, 390, 391, 512 |
| CHAFING HEIZUNG | 389, 512 |
| CHAMPAGNERKÜHLE | 299, 300 |
| COCKTAIL-MATTE | 305 |
| COCKTAIL-TASSEN | 306 |
| COCKTAIL-UTENSILIEN | 305 |
| COCKTAILMASS | 308 |
| COCKTAILSHARKER | 307 |
| CRÉPES-PFANNE | 39, 85, 89, 93, 95, 97, 103, 508 |

D

| | |
|-------------------|--|
| DAMPFKOCH-AUFSATZ | 25, 43, 44, 47, 49, 51, 55, 152 |
| DAMPFKOCHGERÄT | 484 |
| DECKEL | 22, 26, 28, 29, 32, 35, 37, 39, 41, 43, 45, 47, 49, 51, 52, 55, 57, 59, 61, 90, 115, 395 |

| | |
|-------------------------|---------------|
| DEKORIEREN PLASTIKKAMME | 324 |
| DOPPEL-BODEN | 421, 422, 423 |
| DOSIERER | 150 |
| DOSIERFLASCHE | 64, 249 |
| DREIECK | 147 |

E

| | |
|------------------|-----|
| EI-UNTERSTÜTZUNG | 153 |
| EIER-SEPARATOR | 153 |
| EIERFORM | 153 |

| | |
|--------------------------------|---------------|
| EIERKOCHER | 455 |
| EIMER | 178 |
| EIS MACHINE | 460, 552 |
| EIS MACHINEN | 552 |
| EIS-CRUSHER | 307, 553 |
| EISKELCH | 343 |
| EISPORTIONIERER | 343 |
| EITELLER | 231 |
| ELEKTRITOASTER | 406, 528, 529 |
| ELEKTROFLIEGENFÄNGER | 559, 560, 561 |
| ELEKTROGRILL | 501 |
| ENSEMBLE D'USTENSILES | 131 |
| ENTBLÄTTERER FÜR GEWÜRZKRÄUTER | 198 |
| ESPUMADOR DE LEITE | 284, 528 |

F

| | |
|----------------------|--|
| FETTABSCHIEDER | 264 |
| FILTERKAFFEE | 524, 525 |
| FISCHKESSEL | 32 |
| FISCHSCHUPPENTFERNER | 273 |
| FLASCHENKÜHLER | 295 |
| FLASCHENUNTERSETZER | 231 |
| FLEISCHKLOPFER | 160 |
| FLEISCHSPIESSE | 136 |
| FLEISCHTOPF | 21, 24, 27, 29, 30 |
| FLEISCHWOLF | 480 |
| FLEISCHZANGE | 199 |
| FOLIENCUTTER | 309 |
| FONDUE | 263, 510 |
| FRITEUSE | 487, 488, 489, 490, 491, 492, 493, 494 |
| FRITIERLÖFFEL | 126, 200 |
| FRÜHSTÜCKSTELLER | 235, 237, 243, 432, 433 |

G

| | |
|-------------------------|-----------------------------------|
| GASANZÜNDER | 262 |
| GASKOCHER-STÄNDE | 110 |
| GEFLÜGELSCHERE | 217 |
| GEMÜSESCHEIDER | 460, 482, 484 |
| GEMÜSETOPF | 21, 24 |
| GETRANKENPENDER | 392, 523 |
| GEWÜRZDOSE/STREUER | 265 |
| GEWÜRZKASTEN | 163 |
| GLAS | 282, 306, 433 |
| GLASUNTERSETZER | 231 |
| GLOCKE | 260, 399 |
| GN DECKEL | 421, 422, 423 |
| GN ZWISCHENSTENG | 420 |
| GN-BEHÄLTER | 395, 418, 419, 420, 422, 423, 425 |
| GN-BEHÄLTER, PERFORIERT | 419, 420 |
| GRILL | 57, 59, 91, 95, 97 |
| GRILL AKTENTASCHE | 134 |
| GRILLSPIESS | 88 |

H

| | |
|------------------------|------------------------|
| HACKFLEISCHMESSER | 213 |
| HAMBURGER-FORMEN | 159 |
| HAMMER | 160 |
| HANDPRESSE FÜR TOMATEN | 199 |
| HANDSCHUH | 63, 120 |
| HOHER FLEISCHTOPF | 41, 45, 47, 49, 51, 54 |
| HOLZ-STÖSSEL | 147 |
| HONIGBEHÄLTER | 265, 393, 394 |

DE Alphabetischer Index

| | |
|----------------|-----|
| HONIGLÖFFEL | 272 |
| HOT DOG WÄRMER | 456 |
| HUMMERGABEL | 273 |
| HUMMERZANGE | 272 |

I

| | |
|--------------------------------|---------------|
| INOX-BEHÄLTER | 179, 180, 181 |
| ISOLATIONSKUNGLN FÜR SOUS VIDE | 547 |
| ISOTHERMAL SCHALE/TABLETT | 426, 432 |

L

| | |
|---------------------------|----------|
| LEDERSCHNUR | 367 |
| LEISCH BÄRENKRALLEN | 154, 196 |
| LLAUNAS ARROZ | 113 |
| LÖFFELSAMMLER IN GESCHIRR | 136 |

M

| | |
|----------------------------|---|
| MAGNETHALTERUNG FÜR MESSER | 219 |
| MANDOLINE | 202, 203 |
| MANUELLE WURSTTÜLLER | 165 |
| MARKER TAFEL | 362, 556 |
| MASCHINE FUER GLAS COOL | 554 |
| MEHLBEHÄLTER | 149 |
| MEHLSCHAUSEL | 307, 319 |
| MEHLSIEB | 323 |
| MELAMIN | 241, 242, 244, 246, 254, 399 |
| MENAGE | 264 |
| MENÜ-STÄNDER | 363 |
| MENÜKARTENHALTER | 260 |
| MESSER | 134, 191, 192, 193, 208, 209, 210, 211, 212, 214, 215, 216 |
| MESSER-ORGANISATOR | 226 |
| MESSERHALTER | 213, 218 |
| MESSERTASCHE | 213 |
| MESSGERÄT | 175, 176, 318, 321 |
| MIKROWELLE | 497 |
| MILCHKANNE | 290, 292 |
| MILCHTOPF | 31, 41, 43, 45, 47, 49, 51, 52, 55 |
| MINI GRILL | 504 |
| MINI-WÜRFEL | 255 |
| MIXER | 462, 463, 464, 465, 467, 468, 469, 470, 474, 476, 477, 478, 533, 534, 535, 536, 537 |
| MOJITOSTÖSSSEL | 160, 308 |
| MÖRSER | 155 |
| MULTIFUNKTIONS-ROBOTER | 225, 483 |

N

| | |
|-------------------|-----|
| NESTBACKLÖFFEL | 147 |
| NUDELKOCH-EINSATZ | 44 |
| NUSSKNACKER | 272 |

O

| | |
|-------------------------------|---------------|
| OBSTTROCKNER | 485 |
| OFEN | 495, 496, 497 |
| ORGANIZER FÜR COCKTAILZUBEHÖR | 306 |

P

| | |
|----------------|----------|
| PARMESAMENAGE | 224, 260 |
| PASSIERGERÄT | 157 |
| PASTETENFORMEN | 157 |

| | |
|-------------------------|------------------------------------|
| PERSÖNLICHE FLASCHE | 282 |
| PFANNE | 38, 43, 45, 47, 51, 52, 55, 59, 61 |
| PINSEL | 134 |
| PISTOLE FÜR TÜLLENSATZE | 340 |
| PIZZABLECH | 142, 353 |
| PIZZAOFEN-SCHAUFEL | 142, 143 |
| PIZZASCHNEIDER | 143 |
| PIZZASPATEL | 142 |
| PLATTE GRILL | 89, 93, 94, 501, 502 |
| PUDDING-/BECHERFÖRMCHEN | 350, 352, 353 |

R

| | |
|--------------------|-----|
| RACK FÜR SOUS VIDE | 547 |
| RAUCHERGLOCKE | 172 |
| RECLLETTE | 503 |
| RESERVED INDIKATOR | 260 |
| REZEPTIONSKLINGEL | 261 |
| ROLLENHALTER | 539 |
| ROLLFILM | 452 |
| RUHRPATEL | 139 |
| RUNGSTOOLS | 324 |

S

| | |
|----------------------------|---|
| SAHNEBEREITER | 170, 337 |
| SALATSCHÜSSEL | 259 |
| SALZ-PFEFFERTREUER | 266, 267, 284, 524 |
| SATZ-PFEFFER-SET | 264 |
| SAUCENGLIESSLÖFFEL | 142 |
| SAUCIERE | 259 |
| SAUTEUSE | 22, 25, 28, 49 |
| SAUTEUSE, KONISCH | 22, 26 |
| SCHÄLER | 191, 192, 193, 194, 207 |
| SCHÄRFMASCHINE | 220, 221, 557 |
| SCHAUFEL | 324 |
| SCHAUFEL FÜR POMMES FRITES | 140 |
| SCHAUMLÖFFEL | 126 |
| SCHINKENHALTER | 205 |
| SCHNEEBESEN | 291, 465, 471, 472, 473, 475 |
| SCHNEIDEBRETT | 205, 222, 223, 224, 225 |
| SCHNEIDER | 191, 192, 194, 197, 198, 199, 481 |
| SCHNELLKOCHTOPF | 71, 72, 73, 74, 75, 76, 77, 78 |
| SCHOKOLADENKOCHER | 510 |
| SCHÖPFKELLE | 135 |
| SCHÜSSEL | 176, 177, 235, 237, 239, 240, 253, 259, 320, 321 |
| SEIHER, MIT STIEL | 45, 47, 51, 55, 146, 147, 308 |
| SEKTKÜHLER | 296, 307 |
| SEKTKÜHLERSTÄNDER | 298 |
| SERVIERLÖFFEL | 240 |
| SERVIERSCHÜSSEL | 259 |
| SERVIERTABLET | 113, 242, 253, 430, 431 |
| SERVIERTISCH | 247, 253 |
| SERVIERWAGEN | 427, 428, 433 |
| SERVETTENPENDER | 261, 452 |
| SERVETTENROLLE | 451, 452 |
| SILIKONGRIFF | 59, 120 |
| SOSENSPRITZE | 167 |
| SOUS VIDE | 544, 545, 546 |
| SPAGHETTI-MASS | 164 |
| SPEISEKARTENMAPPE | 364, 367, 370, 371, 372, 373, 374, 375, 376, 377, 378, 379, 380, 381, 382 |
| SPICKNADEL | 167 |
| SPRITZBEUTEL | 338 |
| SPÜLKORB | 447, 448 |

DE Alphabetischer Index

| | |
|------------------------------|--|
| STÄNDER EISKELCH | 304 |
| STÄNDER FUER BRENNER | 110 |
| STANDMIXER BRISK | 467, 470 |
| STERILISIERUNGSSCHANK | 548, 558 |
| STIELKASSEROLLE, FRANZÖSISCH | 22, 26 |
| STIELKASSEROLLE, HFLACH | 22, 25, 28, 29, 31, 35, 37, 38, 41, 43, 45, 47, 49, 51, 52, 53, 54, 55, 57, 59, 61, 63, 64, 88, 178, 249 |
| STIELKASSEROLLE, HOCH | 22, 25, 28, 31 |
| STÖSSEL | 155 |
| SUPPENBEREITER | 514, 563, 564, 565, 566 |
| SUPPENSCHÜSSEL | 259 |
| SUPPENTOPF | 21, 24, 28, 29, 31, 38, 41, 43, 44, 46, 48, 50, 52, 53, 54, 61, 452, 501 |

T

| | |
|------------------------|------------------------------|
| TABLETTHALTER | 231 |
| TAFEL | 232, 362, 364, 396, 556 |
| TAFEL FÜR BESTELLUNGEN | 373, 374 |
| TAFEL FÜR RECHNUNGEN | 371, 373, 374 |
| TASSE | 433 |
| TEEKANNE | 290, 291 |
| TEIGAUSSTECHER | 331 |
| TEIGROLLER | 330 |
| TEIGSCHABER | 134, 135, 138, 139, 326, 342 |
| TELLERABDECKUNG | 260, 399, 433 |
| TELLERHALTER | 429 |
| THERMOBEHÄLTER | 280, 281, 282 |
| THERMOMETER | 188, 189 |
| THERMOMOSKANNE | 279, 280 |
| THERMOTRANS | 426 |
| TISCH-VITRINE | 312, 313, 314, 315 |
| TISCHHALTERUNG | 298 |
| TISCHNUMMERNSCHILD | 260, 303 |
| TISCHSET | 275, 276 |
| TISCHTUCHKLAMMER | 260 |
| TISH-ABFALLBEHÄLTER | 261, 450 |
| TORTENNING | 352, 358, 359 |
| TORTENNING, GELOCHT | 359 |
| TORTENTEILER | 342 |
| TRANCHIERGABEL | 134, 212, 214 |
| TRICHTER | 150 |
| TUBULÄRE REGAL | 428 |
| TÜLLENSATZ | 339 |

V

| | |
|---------------------|---|
| VAKUUM-BEHÄLTER | 542 |
| VAKUUMBEUTEL | 542 |
| VAKUUMBEUTEL ROLLEN | 542 |
| VAKUUMIERGERÄT | 162, 538, 539, 540, 541 |
| VERPFLEGUNG | 397 |
| VOLLE REGALE | 436, 437, 438, 439, 440, 441, 442, 443, 444 |

W

| | |
|----------------------|--------------------|
| WANDSPENSER SEIFE | 449 |
| WANDTRENNPFOSTEN | 453 |
| WANNE | 178, 322 |
| WARMHALTEPLATTE | 525 |
| WASSER SAHNEBEREITER | 308 |
| WASSERKANNE | 302, 433 |
| WASSERWARMER | 292, 293, 521, 522 |
| WEINBELÜFTER | 309 |
| WEINKÜHLER | 549, 551 |
| WEINRING TROP-STOP | 309 |

| | |
|-----------------|--|
| WENDEWAFFLEISEN | 507 |
| WETZSTAHL | 213, 215 |
| WOK | 39, 43, 85, 86, 89, 93, 95, 97, 100, 103 |
| WÜRSTCHENGRILL | 456 |

EN Alphabetical index

A

| | |
|-------------|---------------|
| AIRBRUSH | 333, 511 |
| AIRPOT | 392, 523 |
| APPLE CORER | 192, 193, 198 |

B

| | |
|-------------------------|--|
| BAGUETTE MOULD | 354 |
| BAIN MARIE | 26, 28, 341, 509, 514 |
| BARBECUE BRIEFCASE | 134 |
| BASE FOR BURNER | 110 |
| BASKET | 152, 255 |
| BEAR CLAWS FOR MEAT | 154, 196 |
| BELL | 260, 399 |
| BIRD'S NEST MOULD | 147 |
| BISCUIT STAMP | 332 |
| BLACKBOARD | 232, 362, 364, 396, 556 |
| BOTTLE COOLER | 295 |
| BOTTLE STAND | 231 |
| BOWL | 176, 177, 235, 237, 239, 240, 253, 259, 320, 321 |
| BREAD BASKET | 256 |
| BRISK BLENDER STAND | 467, 470 |
| BRUSH | 134 |
| BRUSH FOR CUTTING BOARD | 225 |
| BURNER | 110 |
| BUTTER DISH WITH COVER | 259 |

C

| | |
|--------------|---|
| CAKE CUTTERS | 332 |
| CAKE MARKER | 342 |
| CAKE SPOON | 192 |
| CAKE STAND | 342 |
| CALL BELL | 261 |
| CARAMIZER | 335, 507 |
| CASSEROLE | 20, 23, 27, 29, 30, 35, 37, 38, 41, 43, 44, 46, 48, 50, 52, 53, 54, 56, 57, 59, 61, 65, 395 |

| | |
|------------------------------|--|
| CATERING | 397 |
| CHAFING DISH | 385, 386, 387, 388, 389, 390, 391, 512 |
| CHAFING HEATER | 389, 512 |
| CHEESE/CAKE COVER | 260 |
| CHINESSE STRAINER PUSHER | 147 |
| CHOCOLATE FOUNTAIN | 511 |
| CHOCOLATE MACHINE | 510 |
| CHOPPER | 195, 479 |
| CLEAVER | 213 |
| CLING FILM | 452 |
| COCKTAIL ACCESSORY ORGANISER | 306 |
| COCKTAIL CUPS | 306 |
| COCKTAIL MAT | 305 |
| COCKTAIL SET | 305 |
| COCTAIL SHARKER | 307 |
| COFFEE ORGANIZER | 393 |
| COFFEE PERCOLATOR | 393, 523 |
| COFFEE POT | 285, 286, 287, 288, 289, 290, 526, 527 |
| COIL TUBE | 542 |
| COLANDER WITH STAND | 45, 47, 51, 55, 148, 149 |
| COLD MEAT CUTTER | 481 |
| CONDIMENTS HOLDER | 163 |
| CONICAL DISH | 178, 322 |
| CONICAL SAUTE PAN | 22, 26 |
| CONTAINER | 395, 418, 419, 420, 422, 423, 425 |
| CONTAINER LID | 421, 422, 423 |
| COOK'S CASE | 213 |

| | |
|-------------------|------------------------------------|
| COOKIE CUTTER | 331 |
| COOKIE PRESS | 340 |
| COOLER | 551 |
| CORKSCREW | 310, 311, 550 |
| COUSCOUS POT | 55 |
| COVERING | 117, 350 |
| CREAMER | 290, 292 |
| CREPIERE | 39, 85, 89, 93, 95, 97, 103, 508 |
| CRUET SET | 264 |
| CRUMBS CLEANER | 261, 451 |
| CUP | 343 |
| CUPS STAND | 304 |
| CUTLERY | 226 |
| CUTLERY ORGANIZER | 226 |
| CUTTER | 191, 192, 194, 197, 198, 199, 481 |
| CUTTING BOARD | 205, 222, 223, 224, 225 |
| CUTTLERY HOLDER | 136 |
| CYLINDRICAL POT | 31, 41, 43, 45, 47, 49, 51, 52, 55 |

D

| | |
|-------------------|------------------------|
| DECORATING COMBRE | 324 |
| DEEP CASSEROLE | 21, 24, 27, 29, 30 |
| DEEP SAUCEPAN | 22, 25, 28, 31 |
| DEEP STOCK POT | 41, 45, 47, 49, 51, 54 |
| DEHYDRATOR | 485 |
| DISH CART COVER | 428 |
| DISH MAT | 452 |
| DISPENSER | 265, 393, 394 |
| DISPLAY VASE | 312, 313, 314, 315 |
| DOUBLE BOTTOM | 421, 422, 423 |
| DUMPLING MOULD | 157 |

E

| | |
|------------------|-----|
| EGG COOKER | 455 |
| EGG SERVING DISH | 231 |
| EGG STAND | 153 |
| EGGS SEPARATOR | 153 |
| EXPOSANT | 396 |

F

| | |
|--------------------------------|--|
| FILTER COFFE MACHINE | 524, 525 |
| FISH KETTLE WITH GRILL AND LID | 32 |
| FISH SCRAPER | 273 |
| FLOUR BIN MESH | 149 |
| FOIL CUTTER | 309 |
| FONDUE | 263, 510 |
| FORK | 134, 212, 214 |
| FRENCH SAUCEPAN | 22, 26 |
| FRUIT BOWL | 256 |
| FRY COLANDER | 149 |
| FRYER | 487, 488, 489, 490, 491, 492, 493, 494 |
| FRYING-PAN | 35, 37, 39, 45, 49, 57, 59, 61, 65, 80, 81, 82, 83, 84, 85, 87, 88, 90, 91, 92, 94, 95, 96, 97, 98, 99, 100, 101, 102, 103, 104, 249 |
| FUEL GEL BUCKET | 263, 389 |
| FUNNEL | 150 |

G

| | |
|--------------|---------------|
| GARLIC PRESS | 156, 192, 201 |
| GAS LIGHTER | 262 |
| GAS TORCH | 334, 335 |

EN Alphabetical index

| | |
|----------------------|----------------------|
| GLAS RIMMER | 306 |
| GLASS | 282, 306, 433 |
| GLASS COOLER MACHINE | 554 |
| GLASS STAND | 231 |
| GLOVE | 118, 119 |
| GRATER | 200, 201 |
| GRAVY BOAT | 259 |
| GRAVY LADLE | 142 |
| GRAVY/FAT SEPARADOR | 264 |
| GRILL | 57, 59, 91, 95, 97 |
| GRILL PLAQUE | 89, 93, 94, 501, 502 |
| GRINDER | 266, 267, 284, 524 |

H

| | |
|-----------------|-------------------------|
| HAM-SUPPORT | 205 |
| HAMBURG PRESSER | 159 |
| HAMMER | 160 |
| HEATER | 514, 563, 564, 565, 566 |
| HEATING LAMP | 516, 517 |
| HERB STRIPPER | 198 |
| HONEY SPOON | 272 |

I

| | |
|--------------------------|---------------|
| ICE BUCKET | 296, 307 |
| ICE CREAM MAKING MACHINE | 460, 552 |
| ICE CREAM SCOOP | 343 |
| ICE CRUSHER | 307, 553 |
| ICE CUBES MAKER | 552 |
| ICE SHOVEL | 307, 319 |
| INDIVIDUAL PLACEMENT | 275, 276 |
| INDUCTION PLATE | 498, 499 |
| INOX CONTAINERS | 179, 180, 181 |
| ISOTHERMAL TRAY | 426, 432 |

L

| | |
|-----------------|--|
| LADLE | 135 |
| LEATHER LACE | 367 |
| LID | 22, 26, 28, 29, 32, 35, 37, 39, 41, 43, 45, 47, 49, 51, 52, 55, 57, 59, 61, 90, 115, 395 |
| LLAUNAS ARROZ | 113 |
| LOBSTER CRACKER | 272 |
| LOW CASSEOLE | 37, 56, 57 |
| LOW STOCK POT | 21, 24 |

M

| | |
|-----------------------|---|
| MACE | 160, 308 |
| MAGNET SUPPORT | 219 |
| MANDOLINE | 202, 203 |
| MANUAL STUFFER | 165 |
| MANUAL TOMATO CHOPPER | 199 |
| MARKERS BLACKBOARD | 362, 556 |
| MEASURER | 175, 176, 318, 321 |
| MEAT MINCER | 480 |
| MEAT TENDERIZER | 160 |
| MEAT TONG | 199 |
| MELAMINE | 241, 242, 244, 246, 254, 399 |
| MENU CARD HOLDER | 260 |
| MENU COVER | 364, 367, 370, 371, 372, 373, 374, 375, 376, 377, 378, 379, 380, 381, 382 |
| MENU HOLDER LECTERN | 363 |
| MESH SKIMMER | 126, 200 |

| | |
|---------------------|---|
| MICROWAVE | 497 |
| MILK FROTHER | 284, 528 |
| MINI GRILL | 504 |
| MINI-CUBE | 255 |
| MITTEN | 63, 120 |
| MIXER | 462, 463, 464, 465, 467, 468, 469, 470, 474, 476, 477, 478, 533, 534, 535, 536, 537 |
| MIXING BOWL | 178, 322 |
| MORTAR | 155 |
| MOSKITO KILLER | 559, 560, 561 |
| MULTIFUNCTION ROBOT | 225, 483 |

N

| | |
|---------------|----------|
| NAPKIN HOLDER | 261, 452 |
| NOZZLES | 339 |
| NUT CRACKER | 272 |

O

| | |
|--------------------|---------------|
| OIL CAN | 264 |
| OIL SPRAYER | 264 |
| ORDER HOLDER | 373, 374 |
| ORDER RALL | 136 |
| ORGANIZING BOTTLES | 163 |
| OUSTER OPENNER | 192, 272 |
| OVEN | 495, 496, 497 |
| OVEN TRAY | 32, 355 |

P

| | |
|------------------------|---|
| PAIL | 178 |
| PARMESAN BOWL | 224, 260 |
| PASTA COOKER | 44 |
| PASTA MEASURER | 164 |
| PASTRY BAG | 338 |
| PASTRY MOULD | 345, 346, 347, 348, 349, 350, 352, 353, 355, 356, 358 |
| PEELER | 191, 192, 193, 194, 207 |
| PERFORATED CONTAINER | 419, 420 |
| PERFORATED RINGS | 359 |
| PERSONAL BOTTLE | 282 |
| PESTLE | 155 |
| PIZZA CUTTER | 143 |
| PIZZA FLAT SCOOP | 142, 143 |
| PIZZA MOULD | 142, 353 |
| PIZZA SPATULA | 142 |
| PLATE | 235, 237, 243, 432, 433 |
| PLATE COVER | 260, 399, 433 |
| PLATE HOLDER | 429 |
| PORTIONNER | 150 |
| POTATO CUTTER | 198 |
| POTATO MASHING MACHINE | 157 |
| POTATO PRESS | 156 |
| POURER | 64, 249 |
| PRESSURE COOKER | 71, 72, 73, 74, 75, 76, 77, 78 |
| PUDDING MOILD | 350, 352, 353 |

R

| | |
|-------------------------|----------|
| RACK | 447, 448 |
| RACK FOR DOUS VIDE | 547 |
| RECLLETTE | 503 |
| REMOVABLE GRIP / HANDLE | 35, 102 |
| RESERVED SIGNAL | 260 |

EN Alphabetical index

| | |
|----------------|--|
| RINGS | 352, 358, 359 |
| ROASTER | 26, 32, 112, 114, 115 |
| ROLL DISPENSER | 451, 452 |
| ROLL HOLDER | 539 |
| ROLLING PIN | 330 |
| ROTISSERIE | 88 |
| ROUND | 22, 25, 28, 29, 31, 63, 65, 85, 88, 93, 106, 107, 108, 109, 110, 249 |

| | |
|------------------|------------------------------------|
| ROUND DISH | 38, 43, 45, 47, 51, 52, 55, 59, 61 |
| ROUNDED SAUCEPAN | 31 |
| RTUBULAR SHELF | 428 |

S

| | |
|------------------|--|
| SALAD BOWL | 259 |
| SALAMANDER | 501 |
| SALT-PFEFFER SET | 264 |
| SAUCE SYRINGE | 167 |
| SAUCEPAN | 22, 25, 28, 29, 31, 35, 37, 38, 41, 43, 45, 47, 49, 51, 52, 53, 54, 55, 57, 59, 61, 63, 64, 88, 178, 249 |

| | |
|-----------------|---|
| SAUSAGE COOKER | 456 |
| SAUSAGE ROASTER | 456 |
| SAUTEUSE | 22, 25, 28, 49 |
| SCALE | 182, 183, 184, 185, 186, 187, 319, 555 |
| SCISSORS | 217 |
| SCRAPER | 324 |
| SEAFOOD FORKS | 273 |
| SEPARATOR POST | 453 |
| SERVICE TROLLEY | 427, 428, 433 |
| SERVING TABLE | 247, 253 |
| SERVING TRAY | 231, 232 |
| SHAPE EGG MOULD | 153 |
| SHARKER | 265 |
| SHARPENING | 213, 215 |
| SHEETS | 485 |
| SHELVING | 436, 437, 438, 439, 440, 441, 442, 443, 444 |

| | |
|----------------------------|---------------|
| SHOVEL | 139 |
| SHOVEL FOR FRENCH FRIES | 140 |
| SIEVE | 323 |
| SILICONE HANDLE | 59, 120 |
| SKEWERSQUARE | 136 |
| SKIMMER | 126 |
| SLICER | 164, 194, 199 |
| SMOKER | 171 |
| SMOKER HOOD | 172 |
| SOAP WALL DISPENSER | 449 |
| SOUP-TUREEN | 259 |
| SOUS VIDE | 544, 545, 546 |
| SOUS VIDE INSULATION BALLS | 547 |
| SPATULA | 138, 139, 192 |

| | |
|-----------------------|--|
| SPICE COOKER | 152 |
| SPINNER | 166 |
| SPLITTING GUIDES | 420 |
| SPOON | 240 |
| SPOON HOLDER UTENSILS | 136 |
| SPOUT FOR WINE | 309 |
| SQUEEZER | 161, 530, 531, 533 |
| STEAM CASSEOLE | 25, 43, 44, 47, 49, 51, 55, 152 |
| STEAM COOKER | 484 |
| STEAMER | 152 |
| STOCK POT | 21, 24, 28, 29, 31, 38, 41, 43, 44, 46, 48, 50, 52, 53, 54, 61, 452, 501 |

| | |
|----------|-------------------------------|
| STRAINER | 45, 47, 51, 55, 146, 147, 308 |
| STRAWS | 535 |

| | |
|-----------------|----------|
| STUFFING NEEDLE | 167 |
| SUGAR BOWL | 260, 290 |

T

| | |
|----------------------|--|
| TABLE BIN | 261, 450 |
| TABLE NUMBERS | 260, 303 |
| TABLECLOTH PROTECTOR | 277 |
| TABLECLOTHS PEGS | 260 |
| TEA POT | 290, 291 |
| TERMO JUG | 279, 280 |
| THERMO | 280, 281, 282 |
| THERMOMETER | 188, 189 |
| THERMOTRANS | 426 |
| TICKET HOLDER | 371, 373, 374 |
| TOASTER | 406, 528, 529 |
| TONG | 134, 268, 269, 270, 271, 308, 342, 421 |
| TONGS | 269 |
| TOOLS | 324 |
| TRAY | 113, 242, 253, 430, 431 |
| TRAY STAND | 231 |
| TRIANGLE | 147 |
| TRING | 352 |

V

| | |
|---------------------|-------------------------|
| VACUUM BAGS | 542 |
| VACUUM CANISTERS | 542 |
| VACUUM PACK MACHINE | 162, 538, 539, 540, 541 |
| VEGETABLE DISH | 259 |
| VEGETABLES CUTTER | 460, 482, 484 |
| VINE BUCKET | 299, 300 |

W

| | |
|---------------------|--|
| WAFFLE MAKER | 507 |
| WARMING PLATE | 525 |
| WATER JUG | 302, 433 |
| WATER WHIPPER | 308 |
| WHIPPER | 170, 337 |
| WHISK | 291, 465, 471, 472, 473, 475 |
| WINE AERATOR | 309 |
| WINE COOLER | 549, 551 |
| WINE DRIP STOP RING | 309 |
| WINE STAND | 298 |
| WINE TABLE SUPPORT | 298 |
| WOK | 39, 43, 85, 86, 89, 93, 95, 97, 100, 103 |

PT Índice alfabético

A

| | |
|-----------------------|-------------------------|
| ABERTO-OSTRAS | 192, 272 |
| AÇUCAREIRO | 260, 290 |
| AERÓGRAFO | 333, 511 |
| AFIADOR DE FACAS | 220, 221, 557 |
| AGULHA DE MECHAR | 167 |
| AIRPOT | 392, 523 |
| ANILHA ANTI-GOTA | 309 |
| AQUECEDOR | 514, 563, 564, 565, 566 |
| AQUECEDOR CHAFING | 389, 512 |
| ARDÓSIA | 232, 362, 364, 396, 556 |
| AREJADOR DE VINHO | 309 |
| ARGAMASSA | 155 |
| ARMÁRIO ESTERILIZADOR | 548, 558 |
| ARMÁRIO REFRIGERADOR | 549, 551 |
| ARO | 352, 358, 359 |
| ARO PERFURADO | 359 |
| ASA DE SILICONE | 59, 120 |
| ASSADEIRA | 26, 32, 112, 114, 115 |
| ASSADOR DE SALSICHAS | 456 |
| ATRIL PORTA-MENU | 363 |
| AZEITEIRA | 264 |

B

| | |
|--------------------------------|---|
| BACIA | 176, 177, 235, 237, 239, 240, 253, 259, 320, 321 |
| BACIA CÔNICA | 178, 322 |
| BACIA DA ENSALADA | 259 |
| BALANÇA | 182, 183, 184, 185, 186, 187, 319, 555 |
| BALDE | 178 |
| BANDEJA | 113, 242, 253, 430, 431 |
| BANDEJA / TRAVESSA | 230, 231, 232, 234, 235, 236, 237, 239, 240, 243, 253, 261 |
| BANDEJA DE SERVIR | 231, 232 |
| BANDEJA FORNO | 32, 355 |
| BANDEJA ISOTÉRMICA | 426, 432 |
| BANHO-MARIE | 26, 28, 341, 509, 514 |
| BARRA FIXAÇÃO NOTAS | 136 |
| BATEDEIRA | 462, 463, 464, 465, 467, 468, 469, 470, 474, 476, 477, 478, 533, 534, 535, 536, 537 |
| BATEDOR | 291, 465, 471, 472, 473, 475 |
| BLADE ARREFECEDORA DE GARRAFAS | 299, 300 |
| BOBINA DE VÁCUO | 542 |
| BOBINA FILME | 452 |
| BOQUILHA DE SERVIR | 309 |
| BOQUILHAS | 339 |
| BULE | 290, 291 |

C

| | |
|-----------------------|--|
| CAÇAROLA | 20, 23, 27, 29, 30, 35, 37, 38, 41, 43, 44, 46, 48, 50, 52, 53, 54, 56, 57, 59, 61, 65, 395 |
| CAÇAROLA A VAPOR | 25, 43, 44, 47, 49, 51, 55, 152 |
| CAÇAROLA ALTA | 21, 24, 27, 29, 30 |
| CAÇAROLA ALTA DIREITE | 22, 25, 28, 31 |
| CAÇAROLA BAIXA | 37, 56, 57 |
| CAÇAROLA BOJUDA | 31 |
| CAÇAROLA CÔNICA | 22, 26 |
| CAÇAROLA DIREITE | 22, 25, 28, 29, 31, 35, 37, 38, 41, 43, 45, 47, 49, 51, 52, 53, 54, 55, 57, 59, 61, 63, 64, 88, 178, 249 |
| CAFÉ TIPO FILTRO | 524, 525 |
| CAFETEIRA | 285, 286, 287, 288, 289, 290, 526, 527 |
| CAIXA | 395, 418, 419, 420, 422, 423, 425 |

| | |
|--|--|
| CAIXA CONDIMENTOS | 163 |
| CAIXA PERFURADA | 419, 420 |
| CAIXAS VÁCUO | 542 |
| CAMPAINHA | 261 |
| CAMPÂNULA DEFUMADORA | 172 |
| CANECA CILÍNDRICA | 31, 41, 43, 45, 47, 49, 51, 52, 55 |
| CAPA PROTECTORA CARRO | 428 |
| CARIMBOS PARA BOLACHAS | 332 |
| CARRO SERVIÇO | 427, 428, 433 |
| CENTRIFUGADORA | 166 |
| CEPILHO PARA TÁBUA DE CORTE | 225 |
| CESTA | 152, 255 |
| CHAFING DISH | 385, 386, 387, 388, 389, 390, 391, 512 |
| CHALEIRA | 292, 293, 521, 522 |
| CHÁVENA | 433 |
| CHOCOLATEIRA | 510 |
| CLOCHE PARA PRATOS | 260, 399, 433 |
| CLOQUE PARA QUEIJO/TARTES | 260 |
| COADOR | 45, 47, 51, 55, 146, 147, 308 |
| COBERTO | 226 |
| COLHER LISA | 240 |
| COLHER PARA MEL | 272 |
| COLHER RECOLHE UTENSÍLIOS | 136 |
| CONCHA | 135 |
| CONCHA PARA MOLHO | 142 |
| CONJUNTO DE UTENSÍLIOS | 131 |
| CONJUNTO DE UTENSÍLIOS PARA PREPARAR COCKTAILS | 305 |

| | |
|----------------------------|-----------------------------------|
| CONTENTORES INOX | 179, 180, 181 |
| COPO | 282, 306, 433 |
| COPOS DE COCKTAIL | 306 |
| CORDÃO DE COURO | 367 |
| CORREDOR | 307, 319 |
| CORRENTE | 352 |
| CORTA VEGETALES | 460, 482, 484 |
| CORTA-MASSAS | 331 |
| CORTA-PIZZA | 143 |
| CORTADOR | 191, 192, 194, 197, 198, 199, 481 |
| CORTADOR DE BATATA | 198 |
| CORTADORA DE FIAMBRE | 481 |
| CORTADORES DE BOLO | 332 |
| COUSCOUSEIRAR | 55 |
| COZE-MASSAS | 44 |
| COZEDOR DE ESPECIARIAS | 152 |
| CREMALHEIRA PARA SOUS VIDE | 547 |
| CREPEIRA | 39, 85, 89, 93, 95, 97, 103, 508 |
| CUTELO | 213 |

D

| | |
|----------------------------|-------------------------|
| DECORADOR DE COPOS E TAÇAS | 306 |
| DEFUMADOR | 171 |
| DESCAPSULADOR | 309 |
| DESCAROÇADOR | 192, 193, 198 |
| DESCASCADOR | 191, 192, 193, 194, 207 |
| DESFOLHADOR DE ERVAS | 198 |
| DESIDRATADOR | 485 |
| DISIFICADOR LICOR | 308 |
| DISPENSADOR DE SABÃO | 449 |
| DOSIFICADOR | 150 |
| DUPLO FUNDO | 421, 422, 423 |

E

| | |
|--------------------------|--------------------------|
| EARREFECEDOR DE GARRAFAS | 295 |
| ESCORRE-FRITOS | 149 |
| ESCORREDOR | 45, 47, 51, 55, 148, 149 |

PT Índice alfabético

| | |
|-----------------------------|---|
| ESCORREDOR PARA PRATOS | 452 |
| ESCOVA APANHA-MIGALHAS | 261, 451 |
| ESCUMADEIRA | 126, 200 |
| ESFERAS ISOLANTES SOUS VIDE | 547 |
| ESMAGA-ALHOS | 156, 192, 201 |
| ESPÁTULA | 134, 135, 138, 139, 326, 342 |
| ESPÁTULA DE BOLOS | 192 |
| ESPÁTULA LISA | 138, 139, 192 |
| ESPÁTULA PIZZA | 142, 143 |
| ESPETO MORUNO | 136 |
| ESPETOS PARA MARISCO | 273 |
| ESPREMEDOR | 161, 530, 531, 533 |
| ESPUMADOR DE LEITE | 284, 528 |
| ESTANTE | 436, 437, 438, 439, 440, 441, 442, 443, 444 |
| EXPOSITOR | 396 |

F

| | |
|---------------------|--|
| FACA | 134, 191, 192, 193, 208, 209, 210, 211, 212, 214, 215, 216 |
| FARINHEIRO | 149 |
| FERRAMENTAS | 324 |
| FIO DE COZINHA | 117 |
| FONDUE | 263, 510 |
| FONTE CHOCOLATE | 511 |
| FORMA FLAN | 350, 352, 353 |
| FORMA PARA SALGADOS | 157 |
| FORNO | 495, 496, 497 |
| FRANCÊS CAÇAROLA | 22, 26 |
| FRIGIDEIRA | 22, 25, 28, 49 |
| FRITEDEIRA | 487, 488, 489, 490, 491, 492, 493, 494 |
| FUNIL | 150 |
| FUSIL | 213, 215 |

G

| | |
|--------------------------|--------------------|
| GARFO | 134, 212, 214 |
| GARRAFA DOSEADORA | 64, 249 |
| GARRAFA PESSOAL | 282 |
| GARRAS DE URSOPARA CARNE | 154, 196 |
| GEL COMBUSTÍVEL | 263, 389 |
| GRELHA | 152 |
| GRELHADOR | 57, 59, 91, 95, 97 |
| GUARDANAPO | 261, 452 |
| GUIA DIVISÓRIA | 420 |

I

| | |
|---------------------|----------|
| IMPRESA POTATO | 156 |
| INDICADOR RESERVADO | 260 |
| IOGURTEIRA | 458, 459 |
| ISQUEIRO | 262 |

L

| | |
|------------------|----------|
| LÂMINA | 485 |
| LEGUMEIRA | 259 |
| LEITEIRA | 290, 292 |
| LIQUIDIFICADORAS | 532 |
| LLAUNAS ARROZ | 113 |
| LUVA | 118, 119 |

M

| | |
|---------------------|----------|
| MAÇO | 160, 308 |
| MALA CHEF | 213 |
| MALETA DE CHURRASCO | 134 |
| MANDOLINA | 202, 203 |
| MANGA DE PASTELERIA | 338 |

| | |
|--------------------------------------|---|
| MANTEIGUEIRA | 259 |
| MÁQUINA DE COZER OVOS | 455 |
| MÁQUINA DE COZER SALSICHAS | 456 |
| MÁQUINA DE FAZER GELO | 552 |
| MAQUINA DE FAZER GOFFRES | 507 |
| MÁQUINA DE VACÚO | 162, 538, 539, 540, 541 |
| MÁQUINA PARA ENCHER SALSICHAS MANUAL | 165 |
| MÁQUINA PARA ENFRIAR COPAS | 554 |
| MÁQUINA PARA FAZER GELADO | 460, 552 |
| MÁQUINA/PERCOLADOR DE CAFÉ | 393, 523 |
| MARCADOR DE BOLOS | 342 |
| MARCADORES ARDÓSIA | 362, 556 |
| MARTELO | 160 |
| MARTELO ABLANDADOR | 160 |
| MATA MOSQUITOS | 559, 560, 561 |
| MEDIDOR | 175, 176, 318, 321 |
| MEDIDOR OARA MACARRAO | 164 |
| MELAMINA | 241, 242, 244, 246, 254, 399 |
| MICROONDAS | 497 |
| MINI GRILL | 504 |
| MINI-CUBO | 255 |
| MOINHO | 266, 267, 284, 524 |
| MOLDE OVO | 153 |
| MOLDE PARA HAMBÚRGUERES | 159 |
| MOLDE PASTELERÍA | 345, 346, 347, 348, 349, 350, 352, 353, 355, 356, 358 |
| MOLDE PIZZA | 142, 353 |
| MOLHEIRA | 259 |

N

| | |
|---------------------|----------|
| NINHOS DE ARAME | 147 |
| NÚMEROS PARA TABELA | 260, 303 |

O

| | |
|-----------------------------------|-----|
| ORGANIZADOR ACCESSÓRIOS COCKTAILS | 306 |
| ORGANIZADOR DE CAFÉ | 393 |
| ORGANIZADOR DE FACAS | 226 |
| ORGANIZADOR DE TALHERES | 226 |
| ORGANIZANDO FRASCOS | 163 |

P

| | |
|------------------------|--|
| PÁ | 139 |
| PÁ PARA FRITAS FRANCAS | 140 |
| PAELHEIRA | 22, 25, 28, 29, 31, 63, 65, 85, 88, 93, 106, 107, 108, 109, 110, 249 |
| PAELHEIRA GÁS BUTANO | 110 |
| PANELA | 21, 24, 28, 29, 31, 38, 41, 43, 44, 46, 48, 50, 52, 53, 54, 61, 452, 501 |
| PANELA BAIXA | 21, 24 |
| PANELA DE COCÇÃO | 484 |
| PANELA DE PRESSÃO | 71, 72, 73, 74, 75, 76, 77, 78 |
| PANELA SUPER ALTA | 41, 45, 47, 49, 51, 54 |
| PAPELEIRA | 261, 450 |
| PARTE-NOZES | 272 |
| PASSA-PURÉ | 157 |
| PÉ PORTA BALDES | 298 |
| PEGAS | 63, 120 |
| PEIXEIRA | 32 |
| PENEIRA | 323 |
| PENTE DE DECORAÇÃO | 324 |
| PICADORA | 195, 479 |
| PICADORA DE CARNE | 480 |
| PICADORA DE GELO | 307, 553 |
| PILÃO P/ALMOFARIZ | 155 |

| | |
|-------------------------|---|
| PILÃO P/PASSADOR CHINÊS | 147 |
| PINÇA | 134, 268, 269, 270, 271, 308, 342, 421 |
| PINÇA PARA TOALHAS | 260 |
| PINÇA/PENTE CORTA-CARNE | 199 |
| PINÇAS | 269 |
| PINCEL | 134 |
| PIPETA PARA MOLHO | 167 |
| PISTOLA PASTELARIA | 340 |
| PLACA AQUECIMENTO | 525 |
| PLACA DE FORNO | 116 |
| PLACA DE INDUÇÃO | 498, 499 |
| PLACA VITROCERÂMICA | 500 |
| PLANCHA GRILL | 89, 93, 94, 501, 502 |
| POLVILHADOR | 265 |
| PORTA COMANDAS | 373, 374 |
| PORTA FATURAS | 371, 373, 374 |
| PORTA MENU | 364, 367, 370, 371, 372, 373, 374, 375, 376, 377, 378, 379, 380, 381, 382 |
| PORTA PLACA | 429 |
| PORTA-CUBOS GELO | 296, 307 |
| PORTA-ROLOS | 451, 452 |
| PORTA-TARTE | 342 |
| POSTE SEPARADOR | 453 |
| POUSA-COPOS | 231 |
| POUSA-GARRAFAS | 231 |
| PRATELEIRA TUBULAR | 428 |
| PRATO | 235, 237, 243, 432, 433 |
| PRATO DE OVOS | 231 |
| PROTECTOR DE TOALHAS | 277 |
| PULVERIZADOR | 264 |

R

| | |
|----------------------------|----------|
| RACIONADOR DE GELADO | 343 |
| RALADOR | 200, 201 |
| RASPADOR | 324 |
| RASPADOR DE PEIXE | 273 |
| RECLLETTE | 503 |
| REFRIGERADOR | 551 |
| REMOVÍVEL PEGA / ADERÊNCIA | 35, 102 |
| RESTAURAÇÃO | 397 |
| ROBÔ MULTIFUNCIONAIS | 225, 483 |
| ROLO | 330 |

S

| | |
|------------------------------|--|
| SACA-ROLHAS | 310, 311, 550 |
| SACOS DE VÁCUO | 542 |
| SALAMANDRA | 501 |
| SEPARADOR DE GORDURAS | 264 |
| SEPARADOR DE OVOS | 153 |
| SERTÃ | 35, 37, 39, 45, 49, 57, 59, 61, 65, 80, 81, 82, 83, 84, 85, 87, 88, 90, 91, 92, 94, 95, 96, 97, 98, 99, 100, 101, 102, 103, 104, 249 |
| SHARKER | 307 |
| SIFÃO | 170, 337 |
| SIFÃO DE ÁGUA | 308 |
| SINO | 260, 399 |
| SOPEIRA | 259 |
| SOUS VIDE | 544, 545, 546 |
| SUPORTE BALDE DE ARREFECEDOR | 298 |
| SUPORTE DE OVO | 153 |
| SUPORTE DE ROLO | 539 |
| SUPORTE DE TAPAS | 304 |
| SUPORTE MAGNÉTICO | 219 |
| SUPORTE MENÚ | 260 |

| | |
|------------------------------|----------|
| SUPORTE PAELHERIA | 110 |
| SUPORTE PARA BANDEJAS | 231 |
| SUPORTE PARA BATEDEIRA BRISK | 467, 470 |
| SUPORTE PRESUNTO | 205 |

T

| | |
|-----------------------------|--|
| TÁBUA DE CORTE | 205, 222, 223, 224, 225 |
| TÁBUA DE SERVIR | 247, 253 |
| TAÇA | 343 |
| TACO FACAS | 213, 218 |
| TAMPA | 22, 26, 28, 29, 32, 35, 37, 39, 41, 43, 45, 47, 49, 51, 52, 55, 57, 59, 61, 90, 115, 395 |
| TAMPA PARA CAIXA | 421, 422, 423 |
| TAPETE | 117, 350 |
| TAPETE PARA COCKTAILS | 305 |
| TARTEIRA | 38, 43, 45, 47, 51, 52, 55, 59, 61 |
| TENAZ MARISCOS | 272 |
| TERMO | 280, 281, 282 |
| TERMÓMETRO | 188, 189 |
| TESOURAS | 217 |
| THERMOTRANS | 426 |
| TOALHA DE MESA INDIVIDUAL | 275, 276 |
| TORRADEIRA | 406, 528, 529 |
| TRIÂNGULO | 147 |
| TRITURADOR MANUAL DE TOMATE | 199 |

V

| | |
|--------------------|--------------------|
| VITRINA EXPOSITORA | 312, 313, 314, 315 |
|--------------------|--------------------|

W

| | |
|-----|--|
| WOK | 39, 43, 85, 86, 89, 93, 95, 97, 100, 103 |
|-----|--|

Condições gerais de venda

Conditions générales de vente · Allgemeine Geschäftsbedingungen
General conditions of sale · Condições gerais de venda



ES

- Los precios de la **presente tarifa** anulan los anteriores.
- En los precios están incluidos los **conceptos de embalaje**.
- El **medio de transporte** será a elección de esta Empresa. Cuando se desee el envío por un medio diferente al habitual de **LACOR**, los portes serán **DEBIDOS**.
- La forma de pago será mediante **GIRO DOMICILIADO** y el **plazo máximo** para el pago serán **60 días**. Otras formas de pago deberán ser autorizadas por la dirección de la Empresa.
- Todas las **devoluciones de mercancías** tienen que ser **autorizadas** por la Empresa. Las **devoluciones** que no sean por problemas de calidad deberán llegar a portes pagados y se abonarán al 90% del valor de la mercancía.
- Las **fotos, datos y medidas** que aparecen en este catálogo son indicativos y susceptibles, sin previo aviso, de modificación por exigencias técnicas o de producción.

FR

- Les **présents tarifs** annulent les précédents.
- Dans les prix sont inclus les **concepts d'emballage**.
- Le **moyen de transport** sera au choix de cette entreprise. Si l'on désire l'envoi par un moyen différent à celui pratiqué habituellement par **LACOR**, les ports seront **DUS**.
- La forme de paiement sera par **LETRE DE CHANGE BANCAIRE** et le délai de paiement maximum sera de **60 jours**. D'autres formes de paiement devant être autorisées par la Direction de l'Entreprise.
- Tous les **retours de marchandises** doivent être **autorisés** par l'Entreprise. Les **retours** qui ne seront pas dus à des problèmes de qualité devront arriver avec les frais de ports payés et seront remboursés à 90% de la valeur de la marchandise.
- Les **photos, données et mesures** qui apparaissent dans ce catalogue sont à titre indicatif et sont susceptibles de modifications pour exigences techniques ou de production.

DE

- Die Preise der **vorliegenden Preisliste** annullieren alle vorherigen.
- In den Preisen ist die **VerU.Ventaung** bereits enthalten.
- Das **Transportmittel liegt** im Ermessen dieses Unternehmens. Wenn der Versand durch ein bestimmtes Transportmittel gewünscht wird, das nicht mit dem bei **LACOR** üblichen übereinstimmt, werden die Transportkosten **IN RECHUNG GESTELLT**.
- Die Zahlungsform erfolgt per **EINZUGSVERFAHREN** und das Zahlungsziel beträgt **maximal 60 Tage**. Andere Zahlungsform müssen vor den Geschäftsleitung des Unternehmens genehmigt werden.
- Alle **Retouren von Ware müssen** von der Geschäftsleitung **bewilligt werden**. Die **Retouren**, die nicht Qualitätsprobleme betreffen, müssen mit gezahlten Portokosten geschickt werden. Es werden 90% des Warenwerts zurückerstattet.
- Die in diesem Katalog enthaltenen **Fotos, Informationen und Maße** sind beschreibender Art und können aufgrund technischer oder produktionsbezogener Erfordernisse ohne vorherige Ankündigung geändert werden.

EN

- Current rate** prices cancel prior rates.
- U.Ventaaging** is included in the prices.
- The **transportation method** shall be selected by this Company. When the delivery is requested through other means than the usual **LACOR**, freight be **DUE**.
- The payment method will be **DIRECT PAYMENT** and the payment terms will be a **máximum of 60 days**. Any other type of payment must be authorized by Company management.
- All **merchandise returns** must be **authorized** by the Company. **Returns** not made due to quality concerns must be delivered with freight paid and will be paid at 90% of the merchandise value.
- Photos, information and measurements** that appear in this catalogue are for information and may be modified due to technical or production requirements at any time.

PT

- Os preços do **presente tarifário** anulam os anteriores.
- Nos preços estão incluídos as **taxas de embalagem**.
- O **meio de transporte** será à escolha desta Empresa. Quando se desajar o envio por um meio diferente do habitual da **LACOR**, os portes serão **BEVIDOS**.
- A forma de pagamento será a de **PAGAMENTO DOMICILIADO** e o **prazo máximo** para o pagamento será **60 dias**. Outras formas de pagamento deverão ser autorizadas pela Direção da Empresa.
- Todas as **devoluções de mercadorias** têm de ser **autorizadas** pela Empresa. As **devoluções** que não sejam devidas a problemas de qualidade deverão ser enviadas a portes pagos e serão pagas 90% do valor da mercadoria.
- As **fotografias, dados e dimensões** que constam deste catálogo são indicativos e suscetíveis, sem aviso prévio, de alteração por exigências técnicas ou de produção.

Los portes serán **PAGADOS** a partir de los siguientes importes netos mínimos:

- Península y Baleares : **300€**
- Canarias, Ceuta y Melilla: **600€**
- Francia y Alemania: **775€**
- Reino Unido: **700€ / £600**
- Benelux: **1.400€** e Irlanda: **1.200€**
- Italia: **1.500€**
- Para resto de países **consultar**

Les ports seront **PAYÉS** à partir des montants nets suivants de facture minimums:

- Péninsule Ibérique et Baléares : **300€**
- Canaries, Ceuta et Melilla : **600€**
- France et Allemagne : **775€**
- Royaume Uni : **700€ / £600**
- Bénélux: **1.400€** et Irlande : **1.200€**
- Italie : **1.500€**
- Pour le reste des pays, prière de le **consulter**

Die Transportkosten werden ab folgenden Mindestnettoerechnungsbeträgen von uns **ÜBERNOMMEN**:

- Ibessche Halbinsel und Balearen: **300€**
- Kanaren, Ceuta und Melilla: **600€**
- Frankreich und Deutschland: **775€**
- Vereinigtes Königreich: **700€ / £600**
- Benelux: **1.400€** und Irland: **1.200€**
- Italien: **1.500€**
- Für andere Länder **bitte anfragen**

Freight shall be **PAID** from the following minimum invoice amounts:

- Peninsula and Balearic: **300€**
- Canary Islands, Ceuta and Melilla: **600€**
- France and Germany: **775€**
- United Kingdom: **700€ / £600**
- Benelux: **1.400€** and Ireland: **1.200€**
- Italy: **1.500€**
- For all other countries, please **ask**

Os portes serão **PAGOS** a partir dos seguintes valores líquidos mínimos:

- Península e Ilhas Baleares: **300€**
- Ilhas Canárias, Ceuta e Melilha: **600€**
- França e Alemanha: **775€**
- Reino Unido: **700€ / £600**
- Benelux: **1.400€** e Irlanda: **1.200€**
- Itália: **1.500€**
- Para o resto dos países, **consultar**



Lacor Menaje Profesional, S.L.

Bº San Juan, s/n -Apdo. 18

20570 Bergara (Gipuzkoa), Spain

Tel.: (Nacional) 943-76-90-30 / Fax: 943-76-53-87

Tel.: (Export) +34 943-76-91-74 / Fax: +34 943-76-92-22

comercial@lacor.es / export@lacor.es

Grupo Marcos Larrañaga y Cia



www.lacor.es

Ref. 01741

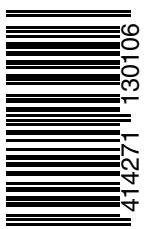

8 414271 130106